

KM 21 FINESSE PLUS electronic
KM 31 FINESSE SUPER electronic
KM 41 FINESSE PROFI electronic

Kompakt-Küchenmaschinen
Compact Food Processors
Robots de cuisine compacts
Macchine compatte da cucina

Gebrauchsanweisung
Operations instructions
Mode d'emploi
Istruccioni per l'uso

AEG

AUS
ERFAHRUNG
GUT

Herzlichen Glückwunsch zum Kauf Ihrer neuen AEG Küchenmaschine. Sie haben ein technisch zuverlässiges Gerät gekauft, welches Ihnen auf vielfache Weise die Zubereitung von Speisen erleichtert.

Wie bei jedem technischen Gerät gilt es auch bei dieser Küchenmaschine einige grundlegende Dinge zu beachten und einzuhalten.

Bitte lesen Sie aus diesem Grund diese Gebrauchsanweisung vor der Inbetriebnahme aufmerksam durch und bewahren Sie sie sorgfältig auf.

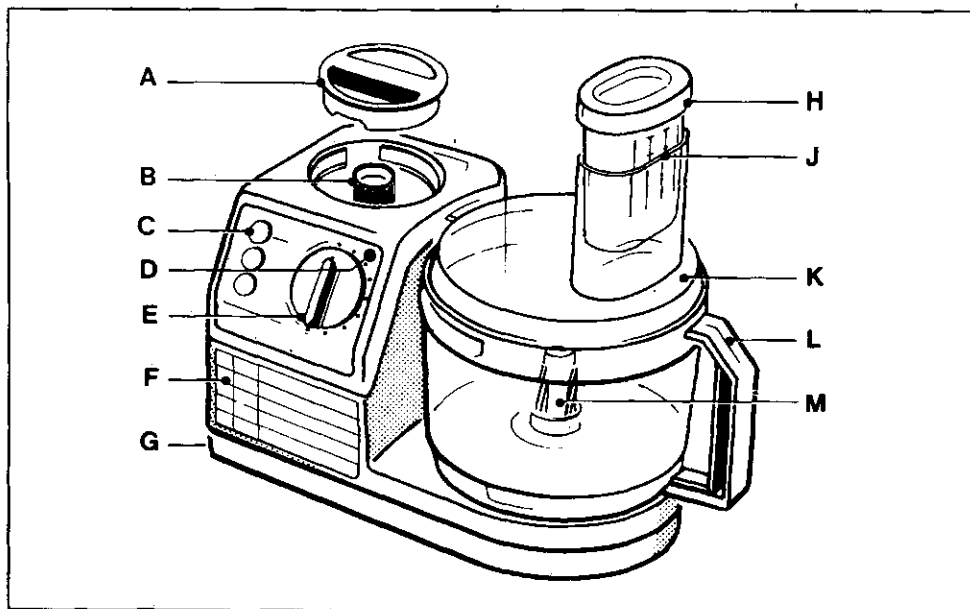

1

KM 21 FINESSE PLUS electronic
KM 31 FINESSE SUPER electronic
KM 41 FINESSE PROFI electronic

Ausstattung

- | | |
|--------------------------------------|------------------------------------|
| A Abdeckung des Mixerantriebs | G Kabelkammer |
| B Antrieb für Mixer bzw. Mini-Hacker | H Stopfer |
| C Funktions-Tasten | J Einfüllöffnung |
| D Kontroll-Leuchte (nur bei KM 41) | K Deckel |
| E Stufenloser Drehzahlwähler | L Arbeitsschüssel |
| F Kurz-Gebrauchsanweisung | M Antrieb für die Arbeitswerkzeuge |

2

Features

- | | |
|--------------------------------------|---------------------------|
| A Cover of mixer driver | G Cable storage |
| B Drive for mixer or mini-chopper | H Pestle |
| C Function buttons | J Filling aperture |
| D Pilot light (only on KM 41) | K Lid |
| E Infinitely variable speed selector | L Working bowl |
| F Brief instructions for use | M Drive for working tools |
-

Equipement

- | | |
|--|---------------------------------------|
| A Couvercle de la commande du mixer | G Logement cordon |
| B Commande pour le mixer ou le mini-hachoir | H Poussoir |
| C Touches de commande | J Orifice de remplissage |
| D Voyant de contrôle (uniquement pour le modèle KM 41) | K Couvercle |
| E Sélecteur progressif pour varier la vitesse | L Bol |
| F Mode d'emploi résumé | M Commande pour les outils de travail |
-

Corredo

- | | |
|---|--------------------------------------|
| A Copertura dell'azionamento del miscelatore | F Istruzioni brevi per l'uso |
| B Azionamento per miscelatore, minisminuzzatore rispettivamente | G Ricettacolo del cavo |
| C Pulsanti di funzionamento | H Pigiatore |
| D Lampadina di controllo (soltanto nel KM 41) | J Apertura di carica |
| E Selettore progressivo del numero di giri | K Coperchio |
| | L Contenitore di lavoro |
| | M Azionamento per attrezzi da lavoro |
-

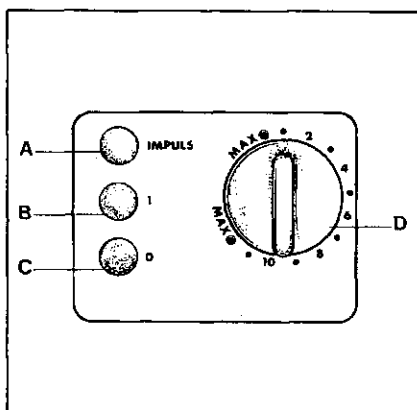

2

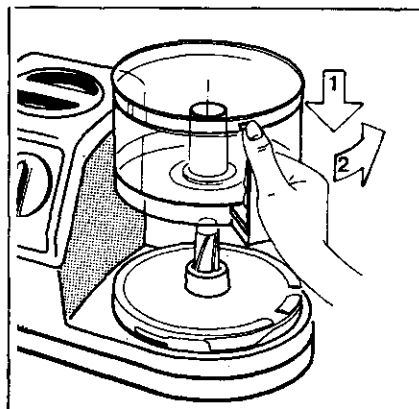

3

3

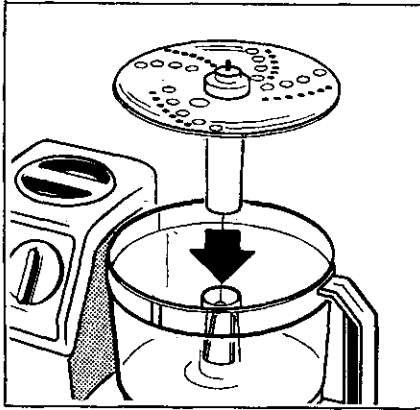

4

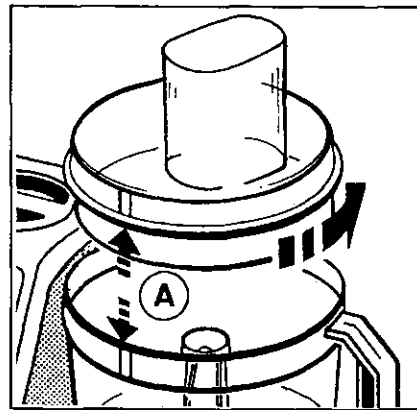

5

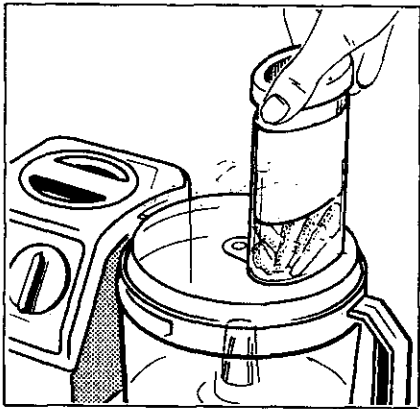

6

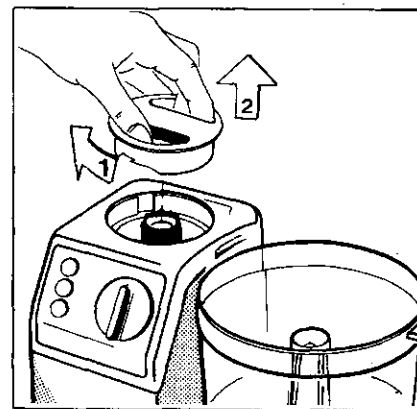

7

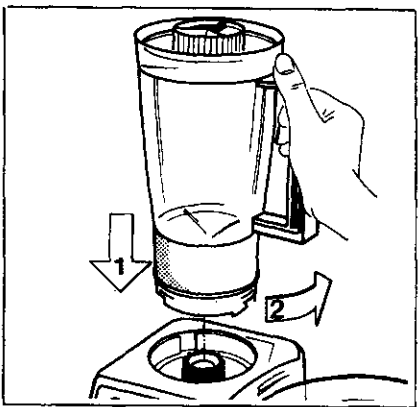

8/A

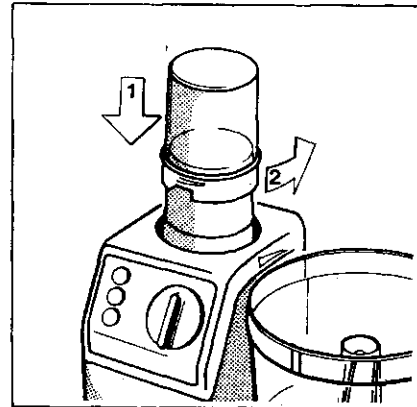

8/B

4

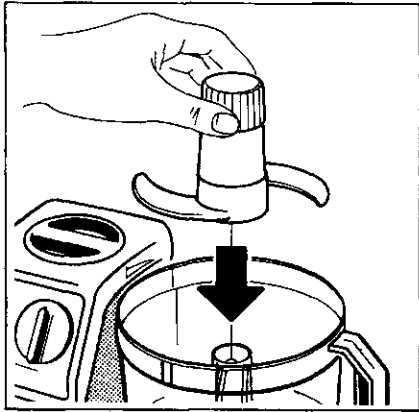

9

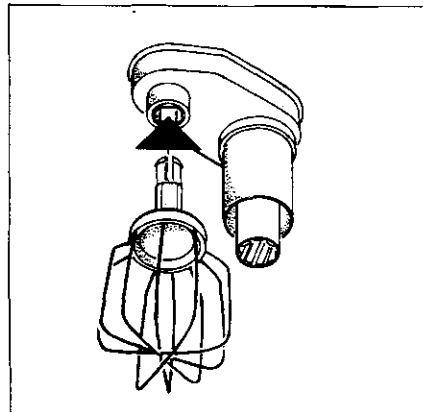

10

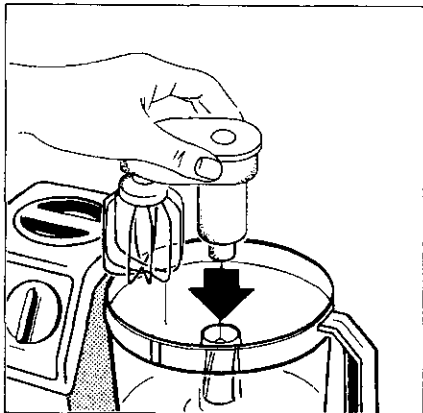

11

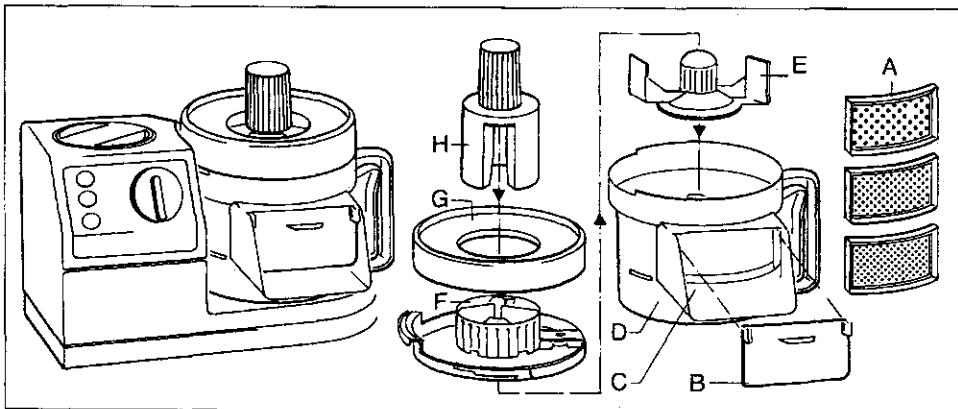

12

Hearty congratulations

on purchasing your new AEG food processor

You have bought a technically reliable appliance with which you will find many kinds of cooking work much easier

As with any technical appliance, there are a number of fundamental points concerning this food processor which require your attention

Please therefore read these instructions for use attentively before using the appliance for the first time, keep them in a safe place for later reference, and pay particular attention to the safety instructions

Please note:

For your safety, this appliance is fitted with an OFF function, which means the electric power supply is cut off if:

- the working bowl
 - the lid
 - the mixing cover
- or, if in use
- the professional puree-ing system
 - the mixer, or
 - the mini-chopper

is not fitted correctly into place on the appliance

Make sure you hear these pieces click into place when you fit them!

Because of this safety function, it is only possible to work with one of the following at a time

- the working bowl
- or the mixer
- or the mini-chopper
- or the professional puree-ing system

Safety instructions

It is essential for you to read these instructions for use attentively before using the appliance for the first time

- The appliance must only ever be connected to a mains supply with the same voltage as that shown on the rating plate (see underside of appliance)
- The appliance must only ever be connected to a properly installed socket

- **Caution! – the appliance must only be used under supervision Pull the plug out even if you are only leaving the room for a moment**

- **Keep children at a safe distance**
- The appliance absolutely must be switched off and the plug pulled out before any cleaning work is done on it or when it is not in use
- Do not pull the plug out of the socket by tugging on the lead
- **Only take hold of the metal knife by its grip – it is extremely sharp! Be very careful when washing as there is a risk of injury Always fit the protective cover when storing the appliance away**

- When the appliance is in use **DO NOT** reach into the filling opening with your fingers **DO NOT** insert any long objects such as kitchen knives, cooking spoons, spatulas, or similar into the filling opening **ONLY** use the pestle to press food down into the opening

- The motor section, the whisk attachment, the mixer, and the mini-chopper **must never be immersed in water**
- Do not bend a kink in the lead Check it from time to time for signs of damage, and arrange for it to be replaced at once if you find any This can only be done in an authorised dealer's workshop or at your AEG Service Centre

- **IMPORTANT: Repairs to electrical appliances must only ever be carried out by a qualified electrician Improper attempts at repair can result in serious danger for the user**

- If there is a defect, please therefore contact your dealer or AEG service centre
- This appliance complies with EC Directive 87/308 EEC on suppressing interference with radio and television signals, EN 55 014/DIN VDE 0875 Part 1, and the standard EN 60 555 Parts 1 to 3/DIN VDE 0838 Parts 1 to 3 on the reciprocal effects on mains supply

These are the features of your appliance:

KM 21 FINESSE PLUS

- Mixer
- Plastic and metal knives
- Whisk attachment
- 1 grating disc for fine and coarse grating
- 1 slicing disc for thin or thick slicing
- 1 potato disc for finely grated potato
- 1 spatula
- 1 cookery book
- simple filling opening
- disc holder

KM 31 FINESSE SUPER

- Same features as KM 21, plus:
- Double filling opening
- Orange/lemon squeezer } (optional extra
- Mini-chopper } on KM 21)

KM 41 FINESSE PROFI

- Same features as KM 31, plus
- Pilot light
- Potato-chipper disc (optional extra on KM 21 and KM 31)
- Professional puree system (not suitable for KM 21 or KM 31)

Location

The appliance should be set up on a level, dry worktop with plenty of "elbow room"

Assembly

The working bowl and all accessories should be clean and perfectly dry before work starts

Fig 3:

Set the working bowl up in such a way that the drive shaft is inside the tube. Lock it in by turning it anti-clockwise (**until you hear it click into place**)

Fig 4:

Fit the accessories onto the drive shaft needed for each kind of work

Fig 5:

Set the lid onto the working bowl with the locking lugs at the rear. The markings on the lid

must be exactly in line with those on the working bowl. Now turn the lid anti-clockwise **until you hear it click into place** in the housing slit

Fig 1/A:

Make sure that the cover of the mixer drive is locked in position (**you can hear it click into place**)

Fig 6:

Only ever use the pestle to close the filler opening and to press the food down into the slicer. Before taking the tools to pieces, always press the "0" button (fig 2/C) and pull the plug out. **Fitting the mixer** (accessory on KM 21, KM 31, and KM 41) and the **mini-chopper** (accessory on KM 31 and KM 41, optional extra on KM 21). Before fitting the mixer or the mini-chopper, release the cover of the working bowl and remove it.

Fig 7:

Remove the cover from the mixer drive

Fig. 8/A and 8/B:

Set the mixer or the mini-chopper on the drive and lock it into position (**you can hear it click into place**)

Cable storage chamber and grips

Fig 1/G:

Your food processor has a cable chamber in its base. If the lead is longer than is needed to reach the socket, the surplus can be stored here. Then press the cable into the openings (in the rear of the base) that grip it.

How to start using your appliance

Fig 2:

There are two buttons and one selector knob on the control panel.

Fig 2/A:

When you press the impulse button the appliance will start, and it will stop again as soon as you let go.

Fig 2/B:

The "1" button will start the appliance and keep it running.

Fig 2/C:

The "0" button switches the appliance off again.

Fig 2/D:

You can use the speed knob to set the right working speed for the food you are working on. Slowest speed 1 (= 0)

Highest speed Max

You can reach the maximum speed either by turning the knob to the left or by turning it as far as it will go to the right.

Working with the double filler opening on the KM 31 or KM 41:

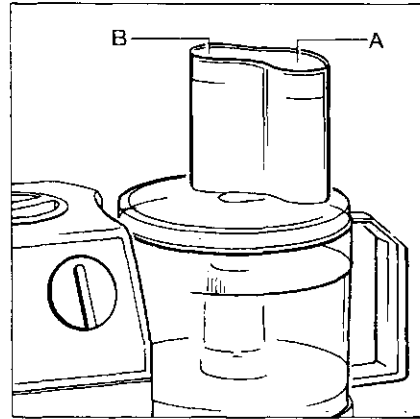

- Large opening (A)
Slicing potatoes, gherkins, etc., grating potatoes, cabbage, carrots, etc. (cut them up first into pieces about 6 or 7 cm – 2 1/2 inches – across)
- Small opening: (B)
Slicing carrots, radishes, small gherkins, etc. into fine slices

When pressing the food down, **only** ever use the pestle (fig 1/H)

The correct accessories for the job concerned

Important: All food processed in your machine must be carefully prepared. Remove pips and stones from fruit. Meat and bacon must be bone-free. In this way, the working tools will be spared.

- Sultanas, currants, or candied fruits can be placed in the work-bowl together with the other ingredients. Best mix them with the flour.
- Close lid

Mixing/kneading with the plastic blade

- Use the plastic blade for all doughs requiring mixing and kneading (fig 9)

For sponge mixes, see under "Beating with the whisk"

- Place all ingredients in the large work-bowl. The addition sequence is very important: first add all dry ingredients, such as sugar, flour, then the soft ones, such as butter, margarine, eggs, followed by any possible liquid.

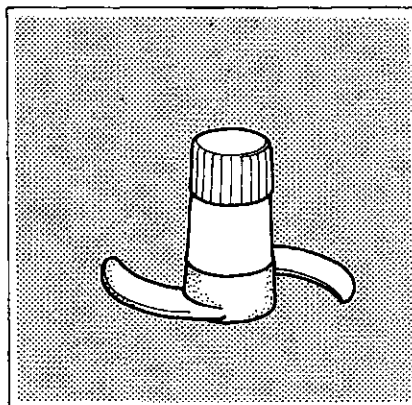

Plastic blade

Pastry-making examples

	Max approx quantity	Setting	Approx duration	Remarks
Scones and teabreads	1250 g	MAX	60 sec	Basic recipe (max quantity): 250 g sugar, 500 g flour, 1 sachet baking powder, 250 g margarine, 3 eggs, 1 pinch salt, 150 ml milk
Yeast dough	1000 g	MAX	60 sec	Basic recipe (max quantity): 500 g flour, 30 g yeast, 50 g sugar, 60 g margarine, 200 ml milk, 1 egg
Short pastry	1000 g	MAX	30 sec	Basic recipe: 60 g sugar, 250 g flour, 1 teasp baking powder, 125 g margarine, 1 egg yolk Allow prepared dough to rest for at least 1 hour
Strudel pastry	1000 g	MAX	30 sec	Basic recipe 250 g flour, 1 pinch salt, 2 tablesp oil, 1 egg, 100 g warm milk Allow pastry to rest for at least 1 hour before further processing

Whipping with the whisk

The whisk attachment with the whisking head is especially well suited for whipped cream, icing sugar, sponge pastry, butter creams, and mayonnaise

For other pastries, the whisk should not be used. Neither should it be used for kneaded doughs

Fitting the whisk attachment

- Insert the stirring head in the openings provided on the underside of the whisk attachment and lightly turn until it engages (fig 10)
- Insert the whisk attachment together with the stirring head (fig 11)
- Place the ingredients little by little in the work-bowl
- Lock together with the lid

- When work is finished, **only place the stirring head** in washing-up water
- Do not wash the whisk or the mixing-bowl in the dish-washing machine

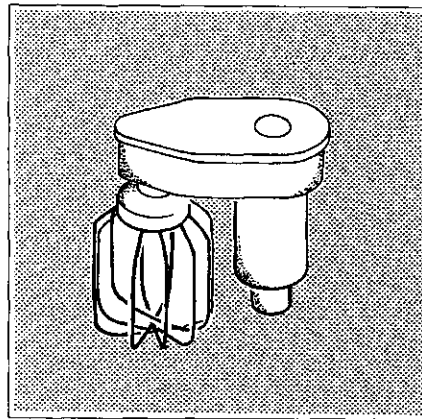

Whisk attachment with stirring head

Whisking examples

	Quantity	Setting	Approx duration	Remarks
Mixed drinks	1-25 litres	1/7	10-20 sec	2 puréed oranges, juice of 2 lemons, 4 dessertspoonfuls glucose sugar, 1 litre milk
Sponge mix	max ca 500 g	MAX	4-5 min	Basic recipe 4 eggs, 3 tablesp hot water, 125 g sugar, 60 g flour, 60 g farina, 1 level teasp baking powder, 1 pinch salt
Icing	2-5	MAX	2 min	
Whipped cream	200-500 ml	MAX	1-4 min	Whipping duration depends on quantity
Cottage cheese dishes	max 800 g	MAX	2 min	
Dips and spreads	max 800 g	6-MAX	1-2 min	

Slicing/grating/chipping with the work-discs

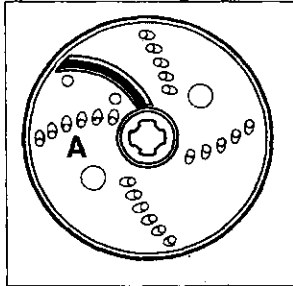

Disc side A
for fine grating

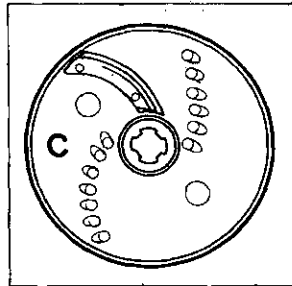

Disc side C
for coarse grating

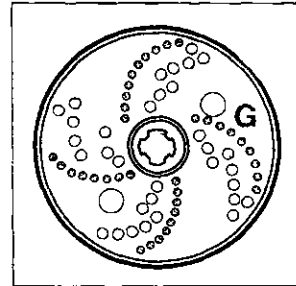

Disc side G
for fine grating (potatoes)

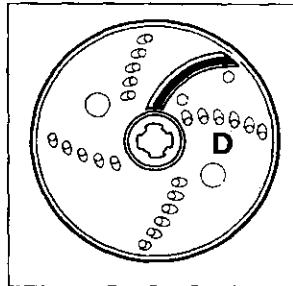

Disc side D
make fine slices

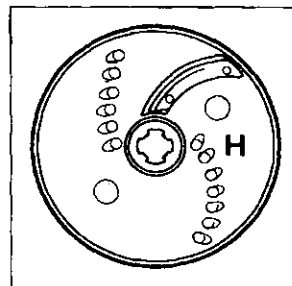

Disc side H
makes thick slices

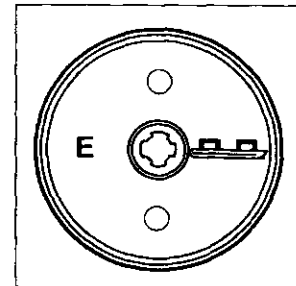

Disc side E chips potatoes
(special accessory
KM 21, KM 31)

Fitting the work-discs (fig 4)

- Insert the disc-holder into the work-disc opening (with the working side facing upwards) and turn until it locks

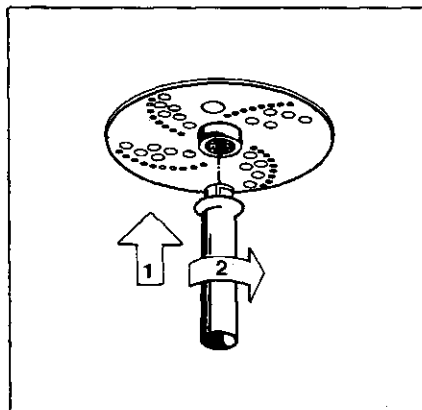

- The required disc side marking must be legible from above when inserting. The discs are to some extent to be used on both sides
- Close lid
- Possibly cut the prepared food to slightly smaller size so that it will fit the feed tube
- Place the inserted food as upright as possible in the feed tube
- Always use the plunger to press the food downwards
- The thickness of the food to be processed can be affected by pressure

Potato-chipping disc (special accessory KM 21, KM 31)

- Fill potatoes with appliance switched off
- Uniformly press down with plunger
- Switch on appliance (setting 1)
- Repeat procedure for next fill

Slicing/grating/chipping examples

	Disc	Max. approx. quantity	Setting	Remarks
Carrots, celery	A, C, D, H, G	900 g	2-4	Cut or grate more finely as raw food or more coarsely as cooked food
Kohlrabi	A, C, D, H, E			
Apples, pears	A, C, D, H	1000 g	1-3	Cut or grate coarsely for baking
Onions	D, H	900 g	1-4	Cut finely for salads and coarsely for frying
Cabbage	C, D, H	900 g	2-4	Cut coarsely for boiling
Cucumbers	D	800 g	1	
Mushrooms	H	500 g	1	
Green and red peppers	D, H	800 g	1-3	
Raw potatoes	D, H	1000 g	2-4	Cut finely for chips and coarsely for preparing "au gratin"
Boiled potatoes	H	1000 g	1	Preboil salad potatoes
Chipped potatoes	E	1000 g	1	Fill with appliance switched off
Potatoes for potato cakes and dumpling	G	1000 g	2-4	
Salami	D, H, E	600 g	1-3	

Chopping and mincing with the mini-chopper (special accessory for Food Processor KM 21)

Fitting:

- Unlock lid of work-bowl
- Place mini-chopper on drive (fig 8/B) and fill

- Lock with lid (fig 8/B)
- Setting: MAX/pulse

This accessory is especially suitable for small quantities, e.g.

- Onions, cabbage, nuts
- Boiled vegetables, parsley, dill

Chopping/mincing/purée-ing with the metal knife

- Insert metal blade (fig 9)
- Place food in work-bowl. Precut large pieces to smaller size
- Lock lid
- The degree of fineness of the processed food is determined by the time for which the appliance is switched on

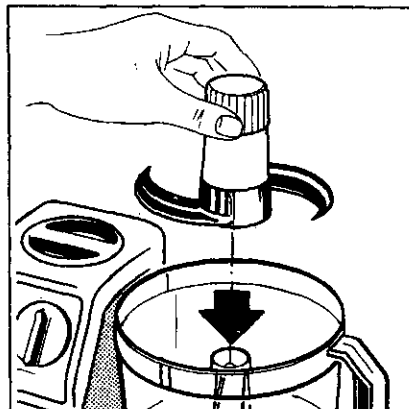

Mincing/purée-ing examples

	Max approx. quantity	Setting	Approx duration	Remarks
Raw meat	500 g	MAX	20 sec	Dice meat Without sinews
Boiled meat	500 g	MAX	10 sec	Dice meat
Ham	300 g	MAX	20 sec	Dice ham
Fish	500 g	MAX	20 sec	Dice fish
Onions	400 g	MAX	10 sec	Quarter onions
Tomatoes	600 g	MAX	30 sec	Quarter tomatoes
Potatoes	500 g	MAX	30 sec	Suitable for potato fritters
Parsley, dill	2 bd	MAX	10-20 sec	After cleaning, dry well
Nuts	400 g	MAX	60 sec	
Dry white bread	200 g	MAX	60 sec	Break white bread into pieces
Chocolate	200 g	MAX	20 sec	Break chocolate into pieces
Potato and vegetable soup	1 litre	7-MAX	10-20 sec	After boiling, dice potatoes and fill the mass with water up to the 1-litre mark
Mayonnaise	max 500 g	MAX	60 sec	Basic recipe 1-2 egg yolks, 1 tablesp vinegar, 1 teasp salt, sugar, pepper to taste, 150-200 ml oil

Pilot light on the KM 41

The equipment is fitted with a fuse which protects the motor in the event of a power surge

If this safety device is tripped, the indicator light will go out

The fuse should then be replaced by an approved engineer or the AEG aftersales service (If any other case the lamp will burn constantly as soon as the appliance is plugged in)

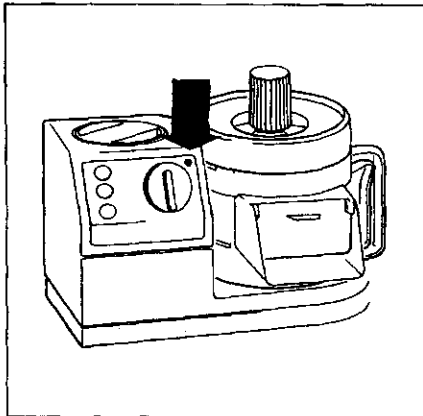

Puree-ing/pressing (only on the KM 41) with the professional puree system

Accessories required:

- Puree attachment (fig 12)

Preparation:

- Check whether the safety cover (1/A) is firmly latched into place on the upper drive (1/B)

Mounting the accessories:

- Slip the puree sieve, with the right perforations for processing food (12/A), into the slots provided in the bowl (12/D)
- Fit the bowl onto the lower drive (1/M) and turn the handle as far as it will go
- Fit the puree insert (12/E) onto the drive shaft
- Fit the lid (12/F) and rotate it as described in the section on "Assembly"
- Fit the flap (12/B) in front of the outlet (12/C)
- Fit the protective lid (12/G) onto the lid (12/F)

- **Only ever use the pestle** to press the food down into the filling aperture (12 H)

Switch position (fig 2):

- Set the speed selector (2/D) at "3"
- Set the button (2/B) to "1" for continuous operation
- **Now fill the food into the filling aperture** – not before

Preparation:

- You can puree up to 4 kilos of fruit and vegetables, e.g. for potato, carrot, spinach, or pea puree, compote, soups, tomato puree, juices, etc
- Please consult the table below to help you select the right puree-ing sieve
- Please see the section on "switch position" for the right speed for each puree-ing process

Instructions:

- Switch the appliance on **before** you fill it with food
- If you wish to process large quantities of fruit and vegetables with stones, peel, or other waste, you should clean the puree-ing sieve out after every 500 grams
- Fill the food slowly into the opening, as this will produce a better result
- Once you have processed a total of about 4 kilos the motor must be left for about one hour to cool.
- Never let the appliance run empty for more than 10 seconds
- Do not attempt to puree deep-frozen food
- Berries (e.g. blackcurrants or redcurrants) are easier to puree if they have first been boiled to soften them

Example: puree-ing/pressing:

Type of food	Preparation	Puree-ing sieve	Instructions
Potato puree	Boil, cut into pieces	Large holes	Pour in a little boiled water or milk towards the end
Carrot puree	Boil, cut into pieces	Medium holes	Pour in a little boiled water towards the end
Celery puree	Boil, cut into pieces	Medium holes	Pour in a little boiled water towards the end
Spinach puree	Boil, dry in colander	Medium holes	Pour in a little boiled water towards the end.
Pea puree	Boil, dry in colander	Medium holes	
Apple or pear compote	Peel, de-core, cut into pieces	Medium holes	
Vegetable soup	Boil, dry in colander	Large holes	Puree with a little clear vegetable soup
Tomato puree	Cut into slices raw or boiled	Large holes	
Strawberry mousse	Remove stalks	Small holes	Increase speed towards end
Raspberry mousse	Raw or boiled	Medium holes	Increase speed towards end
Blackcurrant or redcurrant juice	Boiled	Large holes	Increase speed towards end
Grapes	Remove stalks	Small holes	Increase speed towards end

Blending/pureeing with the blender

Fitting the blender:

- **Unlock lid of work-bowl**
- Place blender on upper drive and turn until it locks (fig 8/A)
- Place all ingredients in the blending beaker
- Fit lid
- **For exclusively liquid ingredients, press pulse buttons**
- **Never fill any boiling liquids**
- For mayonnaise, add the oil through the lid opening
- For batter, fill the liquid ingredients first, then the flour
- The following **cannot** be blended with the blender: mashed potato, icing, raw meat, hard foods, such as coffeebeans, nuts, etc

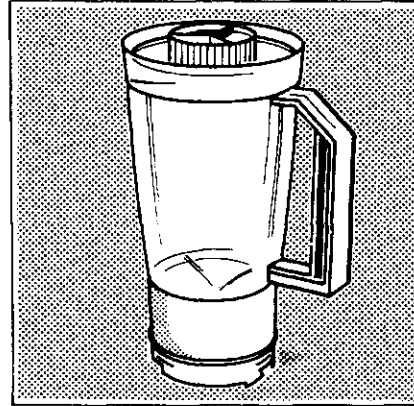

Safety instructions

- **Never place your hand in the inserted blending beaker**
- **Remove the lid only when the blade has come to a complete standstill**

Blending examples

	Max approx quantity	Setting	Approx duration	Remarks
Milkshakes	1 l	4-MAX	10-20 sec	Eg banana milkshake 1 banana, 500 ml milk, 3 teasp cream, 2 teasp sugar, few drops vanilla essence, 1 egg yolk
Soups	1 l	4-MAX	10-20 sec	Puree boiled vegetables (cooled) with around ¼ l boiled water and place back in pan
Mayonnaise	0,4 l	8-MAX	30 sec	Basic recipe: 1 egg, 1 teasp lemon juice, small qty mustard, salt, sugar, around 200 ml oil
Batter	0,8 l	4-MAX	10 sec	Basic recipe: 250 ml milk, 2-3 eggs, 125 g flour, small qty salt
Omelette mix	0,8 l	4-MAX	10 sec	Basic recipe: 8 eggs, 8 teasp cold water, salt and pepper to taste

Juice extraction with the juice extractor

(Special accessory for Food Processors KM 21)

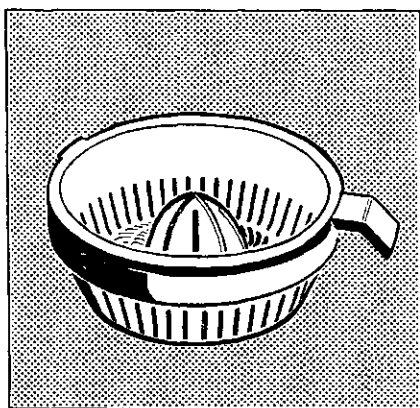

Fitting the juice extractor

- Unlock lid of workbowl and detach
- Insert juice extractor and lock by turning to the left. The locking cam available on the attachment must thereby audibly engage on the housing slot
- **Important note**
The juice extractor should only be operated with setting 1 and the pulse button (fig 2/A)

Cleaning and care

Before cleaning, always unplug your appliance!

Wipe motor compartment and whisk attachment with damp cloth only! Make sure that the slot for the safety interlock is always clean! Clean with wet brush where necessary

Clean all other parts under running tap or in normal washing-up water

The sooner you do this after using your food processor, the simpler this will be!

Never immerse blender and mini-chopper in washing-up water, but brush out using hot water with washing-up liquid

Take special care with the sharp blade and discs!

Dry all parts well

All accessories other than blender, mini-chopper and whisk can also be cleaned in a dishwasher. Arrange the parts in the upper basket

Recipe booklet

Practical hints and instructions are given in the AEG Compact Food Processor Recipe Booklet (only available in German)

For the sake of the environment

Do not simply throw the packaging away

- Cardboard packaging material can be handed in as salvage at your local waste-paper collection point or to the proper waste-disposal system

If the following packaging materials have been used

- Plastic bags made of polythene (PE) can be handed in to your local PE collection point
- Padding made of expanded polystyrol (PS) are free of CFC's

Please ask your local authority for the address of your nearest recycling depot. Used espresso coffee "grouts" are marvellous for composting

After-sales service

We demand the highest quality of ourselves and our products

Should nevertheless have any problem in using this appliance, please write to us

It is only with your help that we will be able to develop appliances which exactly match your requirements

Free Manuals Download Website

<http://myh66.com>

<http://usermanuals.us>

<http://www.somanuals.com>

<http://www.4manuals.cc>

<http://www.manual-lib.com>

<http://www.404manual.com>

<http://www.luxmanual.com>

<http://aubethermostatmanual.com>

Golf course search by state

<http://golfingnear.com>

Email search by domain

<http://emailbydomain.com>

Auto manuals search

<http://auto.somanuals.com>

TV manuals search

<http://tv.somanuals.com>