

COMPETENCE 520 B

AEG

The multi-function build-in single oven

Instruction Book

AUS
ERFAHRUNG
GUT

Hello

Allow me to introduce myself: I am your new AEG cooking appliance. From now on, I should like to make cooking and baking more pleasurable for you. Not simply because of my attractive appearance, but also thanks to "intrinsic qualities". I am economical in terms of energy consumption, easy to operate, and simple to care for. If you carefully read and follow my operating instructions before first use, you are sure to experience a good deal of joy when using me to cook, bake, roast, and grill your food.

You must read these instructions prior to using the appliance and retain them for future reference.



Contents

Safety instructions	
For the installer	4
For the user	4
Appliance description	
Features	5
First use	
Operating the controls	6
Switching on the electronic timer	6
Precleaning the oven	6
Operating the electronic timer	7-10
How to use the oven	
General	11
How to use the cooking functions for the oven	11/12
Switching on and off	13
Baking	13-15
Roasting and stewing	16/17
Grilling	18/19
Specialised applications of the hot air oven	
- Menu cooking	20
- Defrosting	21
- Bottling	22
Cleaning and care	
Oven	23-27
Optional extras	28
What to do if ...	29
Service	30

Safety instructions

For the installer

The safety requirements oblige me to give the following instructions:

When installing cooking appliances into kitchen furniture the enclosed installation instructions must be strictly adhered to.

For the user

- **When you use me to prepare your food, my oven doors and cooking plates become hot. Therefore keep small children well away from me.**

This especially applies when you are grilling or pyrolytically cleaning my oven (where applicable).

- Overheated fat and cooking oil may ignite. Prepare foods requiring fat or oil (chips) only under constant supervision.
- Do not use me to heat your room.
- Take care when using small electrical appliances near the cooker. Connection leads should not come in contact with hot hobs/cooking zones or get trapped in the hot oven door.
- Do not line my oven base with aluminium foil or place any other cooking utensil on my base, as this will trap heat resulting in damage to my enamel interior. This invalidates my warranty.
- The vitreous enamel in your oven is very durable. However vitreous enamel is adversely affected by fruit acids (rhubarb, lemon, etc.) and tea which will discolour and dull the enamel. The performance of the oven is not affected. To prevent spillage of the above coming in contact with the enamel, place the cooking container on a baking sheet.
- **Do not place the grill/meat pan on the cooking plate to make gravy.** The direct heat will weaken the pan base resulting in warping and twisting of the pan when next used as a meat or grill pan.
- I comply with radio interference suppression specifications EN 55014 (previously EEC Directive 82/499) and as appropriate with EN 60555 relating to the Retroactive Effect of the Mains Supply.

Appliance description

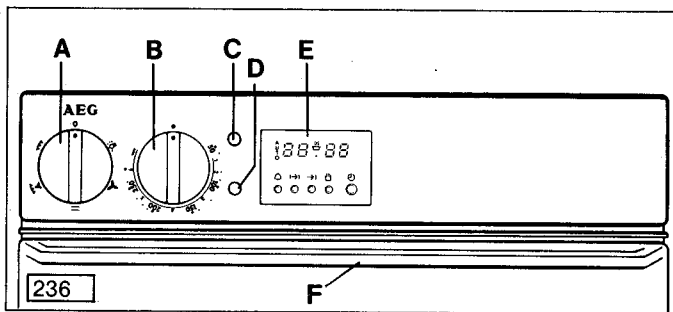

- A** Cooking method selector
- B** Temperature selector
- C** Thermostat control light (red) is on when my oven is heating
- D** Pilot light (yellow) is on when the appliance is switched on.
- E** Electronic clock with minute minder and auto-timer
- F** Handle to open my oven door

Features

First use

Operating the control knobs

My control knob (A) can be turned clockwise or anti-clockwise to any position.

However, my oven temperature control knob (B) must be turned clockwise to set and anti-clockwise to turn off.





Switching on the electronic timer

As soon as I am connected to the mains supply (and also after a power cut), the display in my electronic timer flashes 0.00

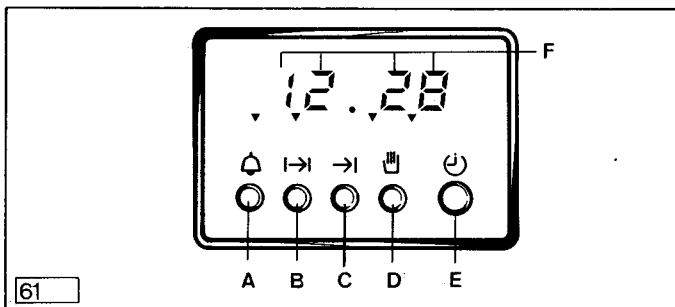
Setting the time of day

Only when you have set me to the correct time of day am I ready to operate.



- Press knob E  to release. (This does not apply to appliances with an enamelled control panel).
- When finished with knob E  press to retract. (This does not apply to appliances with an enamelled control panel).
- Press buttons A  and B  at the same time, hold them in position, and set the actual time of day by turning my knob E .

The time of day appears for you in display F.

- The red triangle above button D  for automatic operation flashes. It is cancelled by pressing button D.

Only now is my oven ready to operate.

Before using my ovens for the first time, clean all accessories with warm water and washing-up liquid. Then switch my oven either to the conventional or the hot air cooking method and select the highest temperature and leave the oven on for at least one hour with the oven door closed.

During this period there is an unavoidable odour which is not harmful to your health. **We recommend that the room is well ventilated for your convenience.**





When my oven has cooled down, clean it with warm water and washing-up liquid.

You should also be aware of the following:

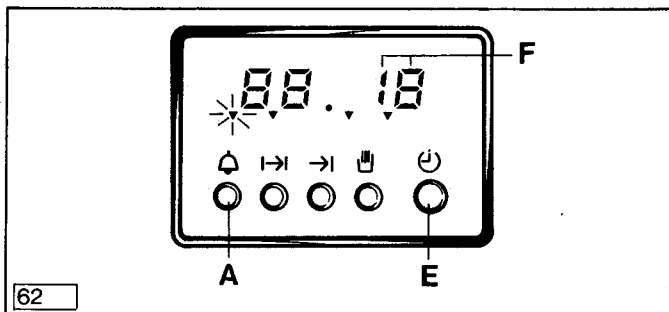
Pre-cleaning the oven

Operating the electronic timer



- Press button A , hold it in position and set the required time with my knob E . The duration appears in display F. The red triangle above symbol  is lit for the entire duration.
- The time of day reappears in display F after release of button A.
- To check the cooking time, press my button A . The remaining cooking time now appears in display F.

When the selected time has elapsed you will hear an audible signal which will switch off automatically after approximately 2 minutes. To switch this off manually press button A .

Setting the minute minder



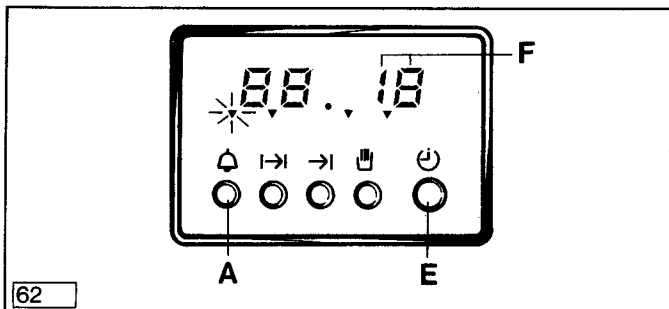

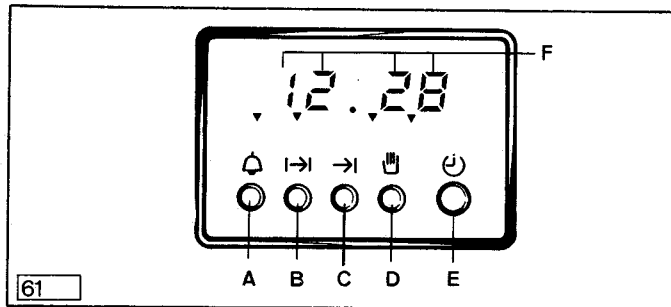

You should also be aware of the following







My electronic timer is designed to switch my main oven on and off automatically.

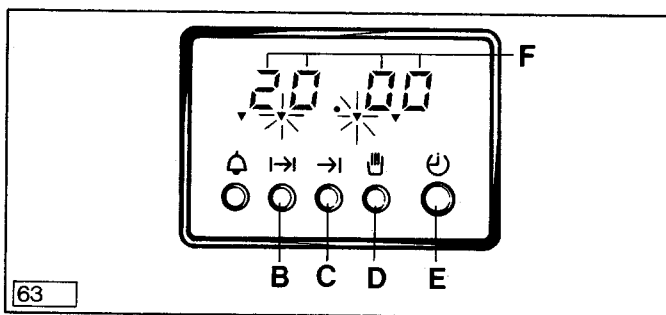

**My symbols
have
the following
meanings:**

-  Setting the **minute minder**
(up to 23 hours 59 minutes)
-  **Manual** or **automatic operation** of the oven
-  Setting the **cooking duration** of the oven
-  Setting the **end** of the cooking duration
(up to 23 hours 59 minutes in advance)
-  **Rotary control for time selections**
-  Indicator symbol, illuminated during time controlled cooking





- Select the cooking method and temperature as required.
- Press my button B , hold it depressed, and enter the required **duration** with knob E . When my button B is released, the time of day reappears in display F.
- The red triangles above the symbols  and  show until the duration has elapsed.



My oven immediately switches on and automatically off after the elapsed duration.

At the end, an audible signal sounds for around two minutes. You can prematurely cancel it by pressing my button B .

After time controlled cooking, set the cooking method selector and temperature control to the off position.

- **The red triangle above button D  flashes. It is cancelled by pressing my button D.**

You can check on the remaining **cooking duration** and the **cooking end** at any time during time controlled cooking by pressing either my button B  or C .

If you want to cancel automatic operation, press my button B  and turn my knob E  until 0.00 appears in the display F. Then press my button D . Then set my cooking method selector to the 0 and oven temperature control to the off position.





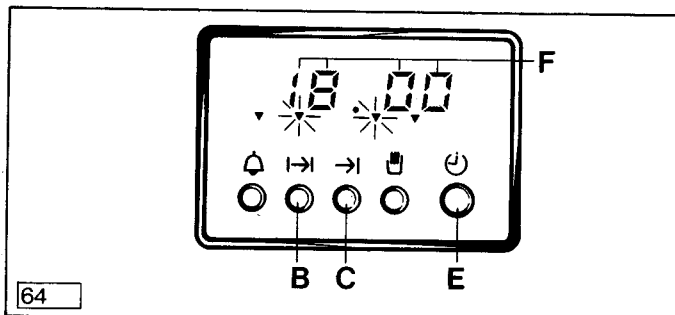

How to programme the oven to switch off automatically

You should be aware of the following:

My oven is ready to operate manually again



Automatic switch-on and -off of my oven

- Set my cooking method selector and temperature control as required.
- Press my button B , hold it depressed, and enter the required **duration** with knob E , and then, by pressing my button C , set the cooking end time.
- When my buttons B  and C  are released, the time of day reappears in display F.
- The red triangles above the symbols , and  show until the duration has elapsed.



You should also be aware of the following:



My oven switches on automatically at the correct time, having deducted the cooking duration from the cooking end. It then switches off automatically at the cooking end.

At the end, an audible signal sounds for around two minutes. You can prematurely cancel it by pressing my button B .

- **The red triangle above button D  flashes. It is cancelled by pressing my button D.**

My oven is ready to operate manually again

You can check the remaining **cooking duration** and the **cooking end** at any time during time controlled cooking by pressing either my button B  or C .

If you want to cancel automatic operation, press my button B  and turn my knob E  until 0.00 appears in the display F. Then press my button D . Then set my cooking method selector to the 0 and oven temperature control to the off position.

Oven

Before using for the first time, refer to the section describing pre-cleaning of the ovens.

My **oven** is a multi-function oven which features conventional cooking with top and bottom heat, hot air cooking and two (three) grilling options. For further details consult the relevant sections in this booklet.

My different cooking options

■ Conventional electric cooking



This method of cooking uniformly radiates heat from above and below. You should however make sure that you only cook on one level to ensure a uniform distribution of heat.

■ Hot air cooking



A fan ensures that hot air is continuously circulated around the oven allowing you to cook, bake and roast at several levels simultaneously. This cooking method also uses lower temperatures. This system saves you time and is highly energy efficient.

■ Rotitherm roasting/grilling



This cooking method combines the fan with the grill element. It replaces the rotisserie in your oven and is an excellent method of roasting/grilling meat and poultry on one level. It is also perfect for "au gratin" dishes.

■ Grilling





The grill element is used to grill foods such as steaks, chops, sausages, fish, etc.

■ Dual-circuit grill



(where featured)

To grill large quantities of food use my large grill area . For smaller quantities e. g., 4 slices of toast, use my smaller grill area .

General

Cooking methods (for main oven in case of double ovens)

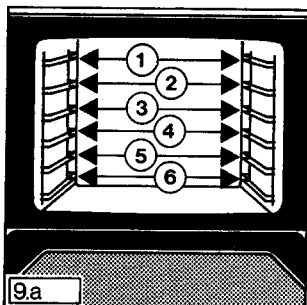

Shelf levels

The shelf positions feature 6 (4) levels, the cooking tables supplied recommend the shelf position on which my oven will produce best results.



Fat filter

The fat filter supplied protects my fan against soiling. It must always be in place when:

- I am used as a Hot Air oven  and meat is cooked in uncovered containers (i. e. do not insert when baking!);
- During Rotitherm roasting/grilling  (on multi-function ovens only).

How to insert my fat filter:

Hold the fat filter by the handle and insert the two tabs (see illustrations) into the slots in the back panel of the oven thereby covering the fan opening. The fat filter must cover the opening completely.

Cleaning the fat filter.

The fat filter should be cleaned after every use. How to clean the filter, see "Cleaning the fat filter" in this booklet.

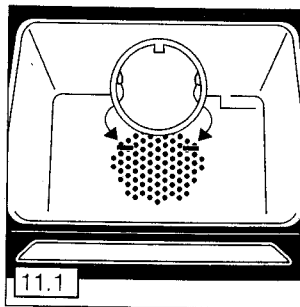
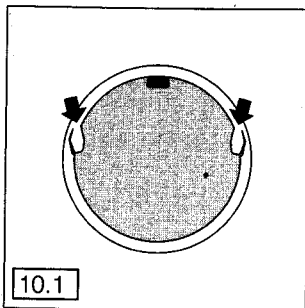

Decide which cooking method you want to use and select the appropriate symbol on the cooking method selector, e. g.,  for Hot Air. Then select the required temperature with the temperature control. The red thermostat light is on for as long as the oven is pre-heating. The thermostat light cycles on and off during operation, indicating heating periods.

When pre-heating my oven (see information in the relevant cooking charts) position food in the oven after the red thermostat light has gone out for the first time. To utilise the residual heat in the oven switch the oven off 5–10 minutes before the end of the cooking time by returning both the cooking method selector and the temperature control to the off positions.

■ Baking

Bakeware

Cakes are baked either in cake tins or alternatively on baking sheets, full width baking sheets are available from AEG Spare Parts as an optional extra.

How bakeware affects browning:

1. Bakeware, which is dark in colour, has a non-stick coating or is made from aluminium is the best as heat is absorbed and then transferred to the cake resulting in shorter cooking times, lower energy and better browning.
2. Bakeware which is light in colour or is made of tin reflect the heat resulting in longer cooking times and poorer browning. It is advisable not to use such bakeware when using conventional top and bottom heat.

■ Baking on one level

Using the conventional method you can only bake on one level at any one time. The shallower the cake, the higher you should place it in my oven.

■ Baking times and temperatures

In many cases, it is not necessary to preheat me. The recommended temperatures and times given in the enclosed chart are guidelines only. To suit personal taste it may be necessary to make small adjustments.

Switching on and off

With conventional top/ bottom heat



**With
hot air**



■ **Recommendations**

I recommend hot air cooking for all types of baking. However, you may prefer cooked cheesecakes, all types of sponges, bread and rich fruit cakes cooked by the conventional method.

When you use my hot air cooking system I can cook on several levels simultaneously. This saves time, is convenient and energy efficient. I can also cook different cakes at the same time for instance a Victoria Sandwich and a Bakewell Tart or a Madeira Cake with a Dundee Cake. Simply make sure that the cooking temperatures are roughly the same and that sufficient space is left between the shelves to allow the air to circulate freely.

If baking cakes with a high moisture content such as several apple pies, it may be advisable to use only 2 shelves at the same time to prevent too much steam forming in the oven.

■ **Baking times and temperatures**

When baking with hot air it is often unnecessary to pre-heat my oven. For exceptions see enclosed baking charts.

If you use my oven for batch baking, choose cakes which require similar temperatures. Different cooking times can be overcome by either placing cakes into the oven later or by removing them earlier.

The baking chart is provided as a quick reference to keep near the oven.

When baking on more than one level the time given in the cooking charts has to be extended by 10-20 minutes.

■ Baking on one or more levels

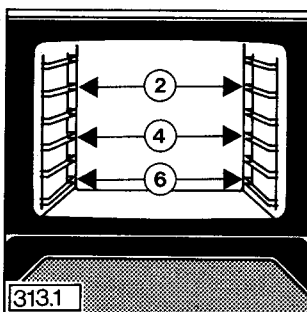
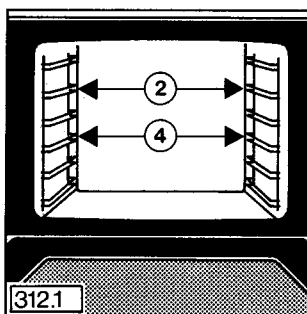
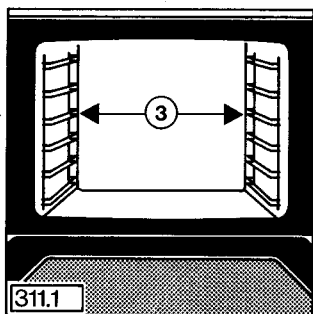

You can bake on several levels simultaneously. Place cake tins centrally on the wire shelves to ensure even cooking results. Full width baking sheets and additional wire shelves are available as optional extras – see section “Optional Extras” in this booklet.

Roasting, Rotitherm roasting/grilling and stewing in the main oven

Cooking temperatures and times

Cooking method

- Choose the most suitable cooking method from my various options:

Conventional top/botton heat



Hot air



Rotitherm roasting/grilling



Where the attached cooking charts highlight shelf positions and temperatures in bold my oven may give you the better result when using this cooking method. However you may wish to experiment and decide for yourself which cooking method gives the best result.

A note to Rotitherm roasting/grilling as this is a relatively new method of cooking meat and poultry although spit roasting which Rotitherm is replacing is not so new. Rotitherm is very much more convenient to use than a spit and once you have tried it you will be delighted with the results.

■ Recommendations

Wipe and weigh the meat. If stuffing is used, weigh the stuffed joint to calculate the cooking time. Place the joint in a suitable roasting dish, season with salt and pepper and brush lean joints with melted fat.

When cooking pies, place dish on a baking sheet to avoid spillage on to the floor of the oven.

- The times and temperatures given in the roasting chart provide a guide when cooking meat. Some adjustments may be necessary depending on the type of meat to be cooked. Cooking times have been given for meat which is at room temperature.
- Prime cuts can be cooked at higher temperatures than those which require a longer cooking time to tenderise the meat. A thick joint will require longer to cook through than a thinner one.
- A boned rolled joint will require a longer cooking time than one with the bone left in as bone is a conductor of heat.
- A small joint will require longer cooking time per 450 g (1 lb) than a large one. Allow an extra 30 minutes cooking time for joints up to and including 1.5 kg (3 lb).
- If the joint is cooked in foil the temperature has to be increased by 10 °C. To brown the joint, remove foil for the last 15 minutes or so of the cooking time.
- If cooking from frozen, place joint in a covered container and extend the calculated cooking time by approximately one third. To brown and crisp meat remove cover for the last 30 minutes of the cooking period.

Never use stainless steel ovenware in my oven, since it reflects the heat. Meat, poultry, and fish should be cooked in ovenproof dishes or in my meat pan for large quantities.

Choose a dish which is just a little larger than the joint itself. This will contain any fat in a smaller area and reduce splashing. If you wish to roast potatoes in the same dish around the joint rather than in a separate one you need to make allowances for this when selecting a suitable dish.

Never place cooking containers on the base of my oven, but on the wire shelf which you should insert on the 4th or 5th level from the top depending on the size of the food to be cooked.

When using the Rotitherm roasting/grilling method (where featured) place the joint on the wire shelf 3rd and 4th from the top (depending on size of roast) and slot the drip-pan into the 5th or 6th from the top to catch the juices. If you want to roast potatoes in the dripping, allow approximately 1-1¼ hours cooking time. Turn the roast over halfway through cooking to ensure an all round crisp and brown joint.

Inserting/removing grill handle

Warning!

The handle must be removed whilst grilling. Failing to do so will result in overheating of the handle. This may cause damage leading to breakage of the handle.

Inserting the handle

Lock it into the grip at the front of the pan. See illustration.

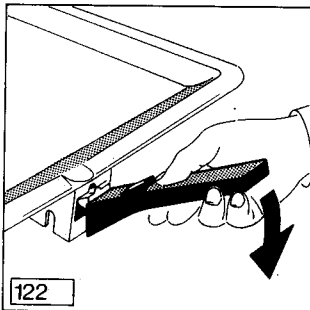

Make sure that the handle is firmly attached to the pan!

Removing the handle

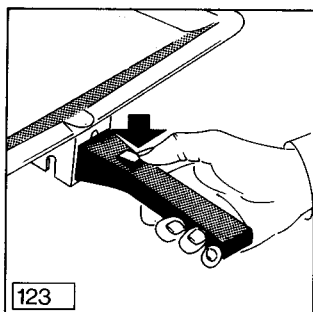

Press the button on the handle. See illustration.



How to use the grill

Prime cuts of meat such as steaks and chops or fish weighing less than 1 kg can either be fried or grilled. Salt large pieces shortly before grilling and small ones just after grilling.

Turn meat/fish after half the grilling time so that both sides are uniformly browned. Turn thin pieces once; thicker pieces need turning more often.

On appliances with a dual circuit grill , you should set the grill to grill symbol  for small amounts and to symbol  for larger amounts.

Select the highest setting on the variable temperature selector to seal the food and then turn down to a lower temperature. Position the wire shelf with the projection facing upwards or downwards in a shelf position of your choice depending on the thickness of the food you wish to grill.

Place the grill pan on the wire shelf and remove the grill pan handle.

Where the appliance features a vapour vent, this must be open during grilling.

The oven door is closed during grilling

There is no need to pre-heat my grill unless you prefer to do so.

Grill pan and wire shelf can be cleaned more easily if soaked in the sink with water and washing-up liquid after grilling.

Traditional grilling



Menu cooking in my main oven

- My hot air oven is extremely versatile since you can cook a complete meal in it. You can cook different foods at the same time, such as fish and cakes, without any transfer of smell or taste from one to the other.

- When menu cooking try to choose foods which require similar cooking temperatures.

- When cooking meat in uncovered containers the **fat filter** must be inserted.

When cooking pies or cakes at the same time as a roast you can choose pies or cakes which normally cook at temperatures 20 °C lower than the roast. Temperature differences of 10 °C lower than the roast can be compensated by longer or shorter cooking times.

Shelf positions are chosen according to the food being cooked and in connection with the cooking guidelines in the recipe book supplied.

Menu suggestion:

Meat Loaf
Potato Bake
Buttered Carrots
Fruity Rice Pudding

Ovenware:

Oblong ovenproof dishes

Shelf positions:

Meat Loaf & Potato Bake
Side by side 3rd from top
Carrots and Fruity Rice Pudding
Side by side 5th from top

Cooking method:

Hot Air

Temperature:

170–180 °C

Time:

Approx. 60–75 minutes

Vapour vent: (where featured)

Open unless you wish to retain moisture in the oven to prevent food from drying out, such as pheasants, etc.

- For bottling, use only jars with rubber seals and glass lids. Never use jars with screw fittings or bayonet catches or metal tins. And make sure you use fresh foodstuffs! The oven holds 6 bottling jars of 1–1.5 litres capacity. Place 1 cup of hot water in the drip-pan so that the necessary humidity is retained in the oven.
 - Position the jars in the enamelled pan on the 4th level from the top. The jars should not touch, must wherever possible be filled to the same level with the same contents and must be securely clamped.
 - Vapour vent (where featured): closed.
 - To **switch on**, turn my cooking method selector to hot air  and the oven temperature control to 160 °C.
 - **Keep an eye** on the food being bottled.
- As soon as the liquid in the first jars (when bottling **fruit** or **gherkins**) begins to bubble (after around 45 minutes for 1 litre jars) switch off the oven, but allow the jars to stand a further 30 minutes or so – around 15 minutes for soft fruit, e. g. strawberries – in the closed oven.
- When bottling **vegetables** or **meat**, set back my oven temperature control to 100 °C as soon as the liquid in the first jars begins to bubble and allow the contents to **cook** for a further 60–90 minutes. Then switch off the oven and allow the jars to stand a further 30 minutes in the closed oven.

Food	Temp. °C	Time - Hours/minutes
Ready-made meals (1-4 portions)	200	0.40-0.50
thawing and heating ready to serve		
Small cakes without cream fillings or top-pings (in foil)	200	0.15-0.20
ready to serve		
Large cakes without cream fillings or top-pings (in foil)	200	0.30-0.45
ready to serve		
Unsliced bread in foil (approx. 450 g/1 lb)	200	0.15 + 0.30
ready to serve		
Bread rolls	200	0.15 + 0.30
ready to serve		
Fruit, e.g. 300 g strawberries, raspberries (in covered container)	200	0.15 + 0.15
ready to serve		
Ready to cook foods (pizza, pies)	200	0.45-1.00
ready to serve		
Uncooked joints (e.g. 1.5 kg) (Chicken approx. 1 kg (cover with greaseproof paper)	180-200	2.00-3.00
thawed and cooked depending on type of meat		
1.00-1.15		
thawed, remove giblets and roast		

Food in flat aluminium containers defrosts especially well since aluminium is a good heat conductor. For freezing and subsequent defrosting of meat and vegetable dishes, flat aluminium containers should therefore be used. For defrosting uncooked frozen meat and fruit, closed ovenproof dishes are especially well suited. Position the containers on the wire shelf or in the meat pan 4th from the top.

Defrosting by hot air

in the main oven

Cleaning and care

These instructions refer to a large range of AEG double and single ovens.

All secondary ovens have a catalytic roof panel as standard. The main oven has catalytic roof (except Vitratherm ceramic roof models), sides and back panels, either as standard or they are available as optional extras from your AEG retailer depending on the model you selected to buy (except ovens which include microwave). If your main oven has a pyrolytic self-cleaning system, then also consult the relevant pages for cleaning the oven.

Before cleaning my ovens

Allow my ovens to cool down if they have been used before cleaning. Switch off the ovens before cleaning.

Cleaning

Ovens which are cleaned after every use need very little attention. If left and used again fat splashes will bake on and are then difficult to remove.

Clean **glass surfaces, trims and controls** with a soft cloth and lukewarm water. Polish dry with a soft cloth.

The ceramic glass oven roof (Vitratherm – where featured) can be cleaned with an oven spray or with "Ovenpad" or "Kleenoff".

Vitreous enamel interior surfaces can be cleaned with:

- a damp cloth and mild detergent
- cream cleaners such as "Jif" and a cloth.
- oven cleaners such as "Ovenpad" or "Kleenoff". Do follow the manufacturer's instruction on the cleaning materials you use carefully.

Take care that oven cleaners do not come in contact with the fan or any other part of the oven other than the vitreous enamel.

Do not use scouring pads or abrasive powder which may scratch the surface of any part of the appliance.

Do not use any detergents, abrasives or oven cleaners on catalytic liners.

It should not normally be necessary to clean the catalytic roof in water. If you feel you would like to do so, take out the roof and wash in warm, soapy water, followed by rinsing in clear water.

Ovens

Catalytic liners

Secondary oven

Main oven

If your oven has a catalytic roof, sides and back panel either as standard equipment or if you have bought these parts separately and fitted them, then the following information will be of interest to you.

The liners help to keep the oven cleaner as they clean themselves to a great extent during roasting and baking at temperatures above 200 °C. As cleaning may be improved by exposure to a higher temperature it may be necessary to run the oven at 250 °C for 1 or 2 hours per week. Before carrying out such a heat cycle, remove all oven equipment and make sure that you have cleaned the unlined surfaces to prevent any soil from baking on. For isolated stubborn stains use a soft brush and very hot soapy water. Never use abrasive cleaners or scouring powders.

Warning! Isolate my oven from supply before replacing my oven lamp.

To clean the glass cover or change my oven lamp the glass cover can be taken off by turning it anti-clockwise.

Cleaning the lamp cover or replacing the oven lamp

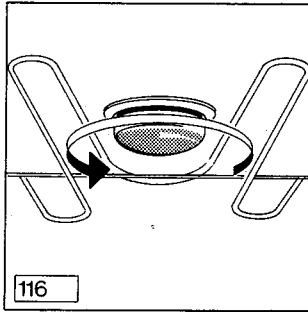

Oven lighting

You can **illuminate** my oven for cleaning. To do this, turn my oven control knob or my cooking method selector to the lamp position .

- Thorough cleaning
 - For thorough cleaning, you can remove various parts:

■ Removing the oven door

Fully open the oven door.

1. Lift the door catch on both door hinges (see illustration).
2. Lift the door up and pull forward away from the oven (**grip the sides – do not pull on the door handle!**).

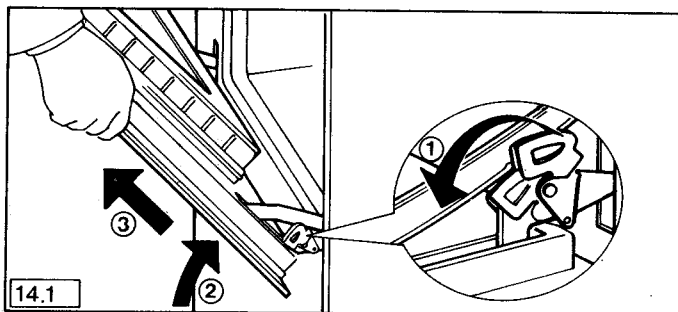

■ Replacing the oven door

1. Insert both brackets into the oven frame.

2. Fully open the door and return door catches to their working positions (see illustration).

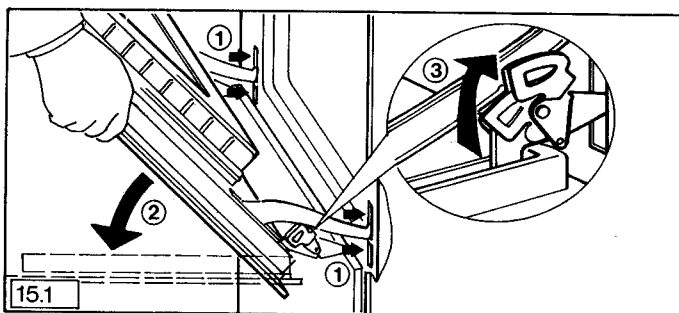

Removing the oven door (main and/or secondary ovens)

Removing the shelf supports

■ Shelf supports

To clean the sides of the oven, the shelf supports (see illustration) can be removed.

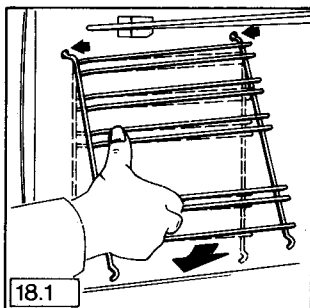

Pull the shelf support at the bottom, towards the centre of the oven and unhook from the top. Replace in reverse order.

Fold down grill/top heating element in the main oven.

My grill/top heating element can be folded down to facilitate occasional cleaning of my oven roof.

Warning! Before you proceed ensure that the element is cold and all my oven controls are switched off.

Turn the 2 holding screws to the centre. The element folds down giving you access to the oven roof (see illustration)

Warning! Do not force the element too far down otherwise you run the risk that it breaks off.

After cleaning, push the element upward and turn the hooks back ensuring that the **crossbar of the element** is secured within the hooks.

The hooks must not be clipped over the element.

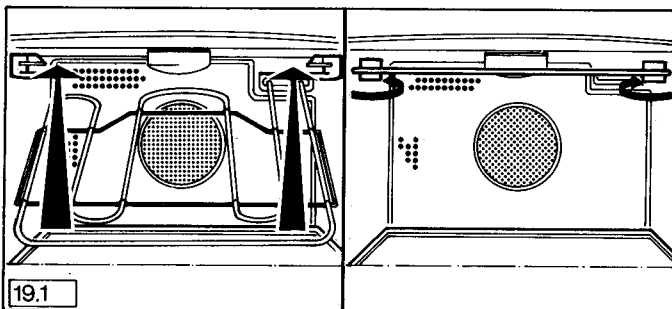

The fat filter should be cleaned after every use. To remove filter, hold it by the handle and lift upwards. Place the fat filter in a saucepan, add approximately 2 tbsp. of automatic washing powder or 1 tbsp. of dishwasher powder and cover filter with water. Bring to the boil and leave to soak for approx. 30 mins. or longer depending on the degree of soiling. Make sure the solution does not boil over as it could mark your hob. Rinse filter in clear water and dry. For light soilage wash in a 65 °C dishwasher programme.

Cleaning the fat filter

Optional extras

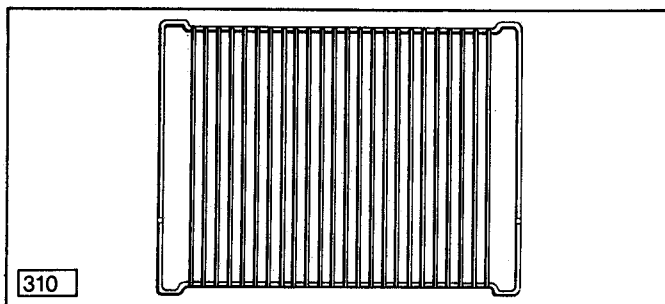

Additional wire shelf
ET No. 661 307 540

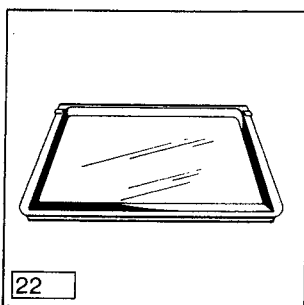

Baking sheet
E No. 611 898 620

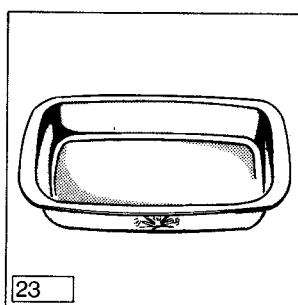

Ceramic oven dish
E No. 611 899 660

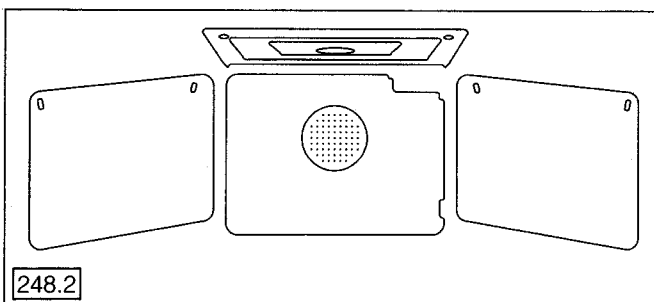

Catalytic set KTU
E No. 611 898 610

What to do if ... (something goes wrong?)

... the pilot lamps do not show?

... the oven does not heat?

1. You may well have not operated all relevant switches or
2. The fuse in the fuse box has blown.

... the fuses keep blowing?

Please call an approved and qualified electrician.

... the oven lamp fails?

See Cleaning and care on page 24.

Replacement lamps are not covered by warranty and are not free of charge.

... the oven cannot be switched on?

Check whether:

- ... you forgot to turn the change-over switch on the automatic timer back to the manual symbol  after time controlled cooking.

Please make sure that you are not able to rectify the fault yourself prior to calling a service engineer in connection with one of the aforementioned problems, as the cost involved will have to be passed on even during the warranty period.

Therefore, follow the instructions in this booklet and any additional information which may accompany this appliance carefully.

AEG electrical appliances comply with current safety regulations. Repairs to these appliances should only be carried out by qualified AEG engineers or AEG appointed service agents. Repairs carried out by unauthorised personnel could lead to considerable damage and could pose a considerable safety hazard to the user.

Faults you can rectify yourself

Service

Should you be unable to locate the cause of the problem in spite of the above check-list please contact your AEG service department quoting the E and F numbers which you will find on the rating plate (see illustration/arrow).

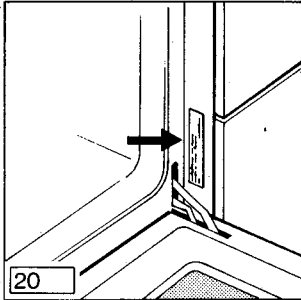

Please transfer these numbers to the space provided below for your convenience.

These numbers enable the service department to prepare as far as possible any spare parts required to rectify the fault on first call. This may save you money.

E-No.

F-No.

AEG

AUS
ERFAHRUNG
GUT

AEG Hausgeräte AG
Postfach 1036
D-8500 Nürnberg 1

© Copyright by AEG

H 260 210 740 – 07911./03 –

Free Manuals Download Website

<http://myh66.com>

<http://usermanuals.us>

<http://www.somanuals.com>

<http://www.4manuals.cc>

<http://www.manual-lib.com>

<http://www.404manual.com>

<http://www.luxmanual.com>

<http://aubethermostatmanual.com>

Golf course search by state

<http://golfingnear.com>

Email search by domain

<http://emailbydomain.com>

Auto manuals search

<http://auto.somanuals.com>

TV manuals search

<http://tv.somanuals.com>