

SANTO 72358 KA3

Electronic Refrigerator

Operating Instructions

Dear customer,

Before placing your new refrigerator into operation please read these operating instructions carefully. They contain important information for safe use, for installation and for care of the appliance.

Please keep these operating instructions for future reference. Pass them on to possible new owners of the appliance.

These operating instructions describe the refrigerator part of your side-by-side combination fridge-freezer.



Notes which are important for your safety or for the proper functioning of the appliance are stressed with a warning triangle and/or with signal words (**Warning!**, **Caution!**, **Important!**). Please observe the following carefully.



1. This symbol and numbered instructions guide you step by step in the operation of the appliance.

2.



Supplementary information regarding operation and practical uses of the appliance appear after this symbol.



Tips and notes concerning economical and environmentally sound use of the appliance are marked with the cloverleaf.

Explanations of the technical terminology used in the operating instructions can be found at the end in the section "Technical Terminology".

The operating instructions contain instructions for the correction of possible malfunctions by the user in the section "What to do if ...". If these instructions should not be sufficient, please contact your local AEG Service Force Centre.

Printed on paper manufactured with environmentally sound processes.
he who thinks ecologically acts accordingly ...

Contents

Important Safety Instructions	5
Environmental Information	6
Appliance Transport	7
Before Use	8
Packaging	8
Installation	9
Installation Location	9
Appliance Alignment	9
The Refrigerator needs Ventilation	10
Installation of the carbon filter	10
Electrical Connection	11
Description of the Appliance	12
Control Panel	13
Buttons for Adjusting the Temperature	13
Temperature Display	14
COOLMATIC button	14
Quick chill	15
ALARM OFF button	15
Prior to Initial Start-Up	16
Initial Start-Up	16
Temperature Adjustment	16
Switching the Appliance off	17
Holiday Mode	18
Opening the Door	18
Control and Information Systems	19
"Open Door" Warning	19
Temperature warning	19
Function Errors	19

Interior Fittings	20
Storage Shelves	20
Variable Inner Door	20
Salad Bin	20
Bottle Rack	21
Quick Chill Shelf	21
Bottle and Can Holder	22
Dismantling of the Bottle and Can Holder	22
Bottle Holder	22
Proper Storage	23
Hints and Tips	24
Normal Operating Sounds	24
Food Storage	24
Energy Saving Advice	24
Defrosting	25
Maintenance and Cleaning	25
Internal Cleaning	25
External Cleaning	25
Changing the carbon filter	26
Replacing the Light Bulb	26
What to do if	27
Regulations, Standards, Guidelines	29
Technical Terminology	29
Guarantee Conditions	30
Service & Spare Parts	31



Important Safety Instructions

These warnings are provided in the interests of your safety. Ensure that you understand them all before installing or using this appliance. Your safety is of paramount importance. If you are unsure about any of the meanings of these warnings contact the Customer Care Department.

Prior to Installation

- Check the refrigerator for transport damage. Under no circumstances should a damaged appliance be installed! In the event of damage, please contact your retailer.

Installation

- This appliance is heavy. Care should be taken when moving it.
- It is dangerous to alter the specifications or attempt to modify this product in any way.
- Ensure that the appliance does not stand on the electrical supply cable. If the supply cable is damaged, it must be replaced by a cable available from your local Service Force Centre.
- Make sure that the power plug is not squashed or damaged by the back of the appliance. A damaged power plug may overheat and cause a fire.
- If the power plug socket is loose, do not insert the power plug. There is a risk of electric shock or fire.
- Any electrical work required to install this appliance should be carried out by a qualified electrician or competent person.
- Parts which heat up should not be exposed. Whenever possible, the back of the appliance should be close to a wall, but leaving the required distance for ventilation, as stated in the installation instructions.
- The appliance should be left for 2 hours after installation before it is turned on, in order to allow the refrigerant to settle.

Refrigerant

The refrigerant isobutane (R600a) is contained within the refrigerant circuit of the appliance, a natural gas with a high level of environmental compatibility, which is nevertheless flammable.

- During transportation and installation of the appliance, be certain that none of the components of the refrigerant circuit become damaged.

- If the refrigerant circuit should become damaged:
 - avoid open flames and sources of ignition;
 - thoroughly ventilate the room in which the appliance is situated.

Child Safety

- Do not allow children to tamper with the controls or play with the product.
- Keep packaging material away from children! (There is a risk of suffocation!)

During Use

- This appliance is designed for domestic use only, specifically for the storage of edible foodstuffs only. It is not intended for commercial or industrial use.
- Containers with flammable gases or liquids can leak at low temperatures. Do not store any containers with flammable materials such as, spray cans, fire extinguisher refill cartridges etc in the refrigerator.
- Manufacturers' recommended storage times should be adhered to. Refer to relevant instructions.

Maintenance and Cleaning

- Before cleaning, always switch off the appliance and disconnect from the electrical supply.
- When unplugging always pull the plug from the mains socket, do not pull on the cable. Damage to the cord may cause a short circuit, fire and/or electric shock.

Servicing

- This product should be serviced by an authorised engineer and only genuine spare parts should be used.
- Under no circumstances should you attempt to repair the appliance yourself. Repairs carried out by inexperienced persons may cause injury or serious malfunctioning. Contact your local AEG Service Force Centre.

Environmental Information



Packaging material

The packaging materials are environmentally friendly and can be recycled. The plastic components are identified by markings, e.g. >PE<, >PS<, etc. Please dispose of the packaging materials in the appropriate container at your local waste disposal facilities.



Old appliance

The symbol  on the product or on its packaging indicates that this product may not be treated as household waste. Instead it shall be handed over to the applicable collection point for the recycling of electrical and electronic equipment. By ensuring this product is disposed of correctly, you will help prevent potential negative consequences for the environment and human health, which could otherwise be caused by inappropriate waste handling of this product. For more detailed information about recycling of this product, please contact your local city office, your household waste disposal service or the shop where you purchased the product.

When disposing of your old appliance:

Make the appliance unusable by cutting off the cable and remove any door catches to ensure small children cannot be trapped inside.

Help to keep your country tidy - use an authorised disposal site.

Appliance Transport

Two persons are required for transport of the appliance. There are two recessed handles at the front of the base and at the back of the appliance at the top for improved gripping.

-  1. Grip the appliance with the recessed handles positioned as in the drawing, and transport the appliance.

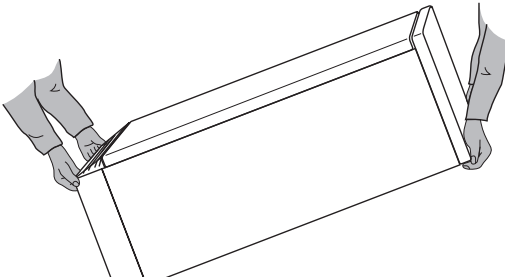

2. In order to push the appliance into its final position, press carefully at the top of the door and tip the appliance back slightly. The weight is then transferred to the back wheels and the appliance can be easily pushed.

Before Use

Packaging

 1. Remove all adhesive tape and packaging from the interior of the appliance.

 Any remnants of adhesive can be removed with white spirit.

2. Remove the transport protection pieces and pull off the adhesive tape.

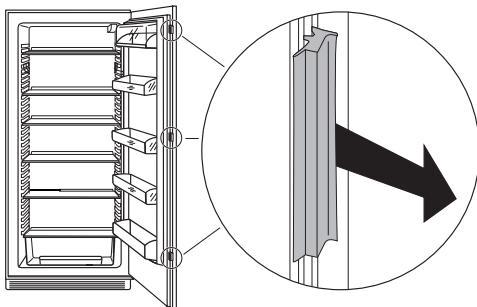

3. Wash the inside of the appliance with lukewarm water with a little bicarbonate of soda added (5 ml to 0.5 litre of water). Do not use soap or detergent as the smell may linger. Dry the appliance thoroughly.

Remove the transport fittings from the storage shelves:

4. Slide the fittings securing the shelf forward to the thicker section on the edge of the storage shelf.

5. Slide the storage shelf far enough forward so that it can be hinged downwards and the fittings can be removed from the guides.

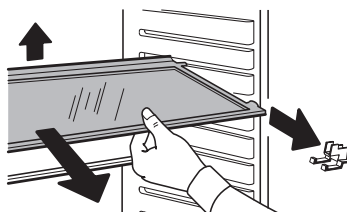
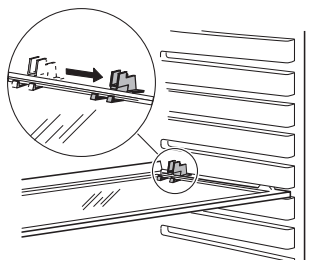

Installation

The position of the freezer part and the fridge part in the combination fridge-freezer can be decided by the customer. However the final assembly of the appliance or a later change in the position of the freezer and fridge must be carried out by your local Service Force Centre.

Installation Location

The appliance should be installed in a well ventilated, dry room. Energy use is affected by the ambient temperature.

The appliance should therefore

- not be exposed to direct sunlight;
- not be installed next to radiators, cookers or other sources of heat;
- only be installed at a location whose ambient temperature corresponds to the climate classification, for which the appliance is designed.

The climate classification can be found on the rating plate, which is located at the left on the inside of the appliance.

The following table shows which ambient temperature is correct for each climate classification:

Climate classification	for an ambient temperature of
SN	+10 to +32 °C
N	+16 to +32 °C
ST	+18 to +38 °C
T	+18 to +43 °C

Appliance Alignment

-  1. The appliance must be level, please compensate for unevenness in the floor by turning the two adjustable feet at the front.

The Refrigerator needs Ventilation

Air is fed under the door through the vent slots in the base and is exhausted upwards along the back wall. To ensure proper air circulation never cover or alter the vent openings.

Important! If the appliance is installed under a hanging cabinet, a clearance of at least 10 cm between the top of the appliance and the cabinet above it must be maintained.

Please check whether, after installing your appliance and especially after reversing the door, the door seal fits tightly. A badly fitting door seal may lead to heavy frosting and a higher power consumption (see also "What to do if ...").

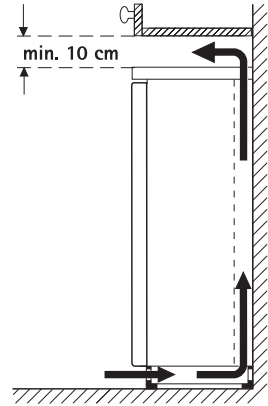

Installation of the carbon filter

On delivery the carbon filter is placed in a plastic bag to ensure the length of life of the carbon filter. The filter should be placed behind the grill before the cabinet is turned on.



1. The cover can be opened by simultaneously pressing the lever on the right of grill (1) and pulling the cover outward (2).

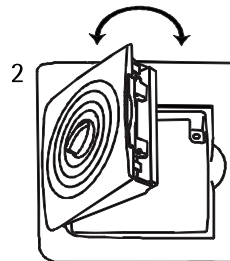
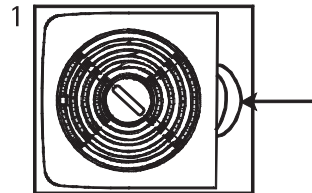

2. The carbon filter is then mounted in the slot found in the back of the cover (3).

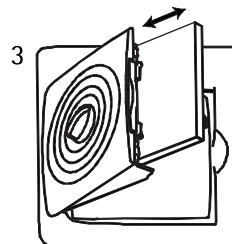

The filter should be handled carefully so fragments don't loosen from the surface.

Electrical Connection

Any electrical work required to install this appliance should be carried out by a qualified electrician or competent person.



WARNING – THIS APPLIANCE MUST BE EARTHED

The manufacturer declines any liability should these safety measures not be observed.

Before switching on, make sure the electricity supply voltage is the same as that indicated on the appliance rating plate. The rating plate is inside, on the left.

The appliance is supplied with a 13 amp plug fitted. In the event of having to change the fuse in the plug supplied, a 13 amp ASTA approved (BS 1362) fuse must be used.

Important

The wires in the mains lead are coloured in accordance with the following code:

Green and Yellow	Earth
Blue	Neutral
Brown	Live

As the colours of the wires in the mains lead of this appliance may not correspond with the coloured markings identified in the terminals of your plug, proceed as follows:

1. The wire coloured green and yellow must be connected to the terminal marked with the letter "E" or by the earth symbol \oplus or coloured green and yellow.
2. The wire coloured blue must be connected to the terminal "N" or coloured black.
3. The wire coloured brown must be connected to the terminal marked "L" or coloured red.
4. Upon completion there must be no cut, or stray strands of wire present and the cord clamp must be secure over the outer sheet.

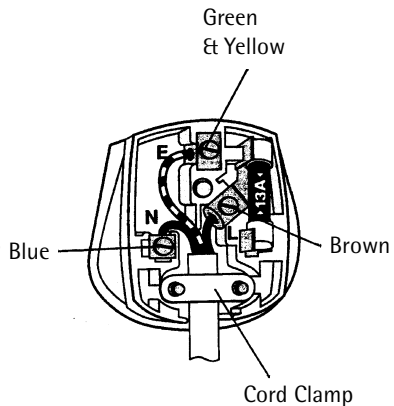

Warning! A cut-off plug inserted into a 13 amp socket is a serious safety (shock) hazard. Ensure that the cut-off plug is disposed of safely.

Description of the Appliance

View of the appliance

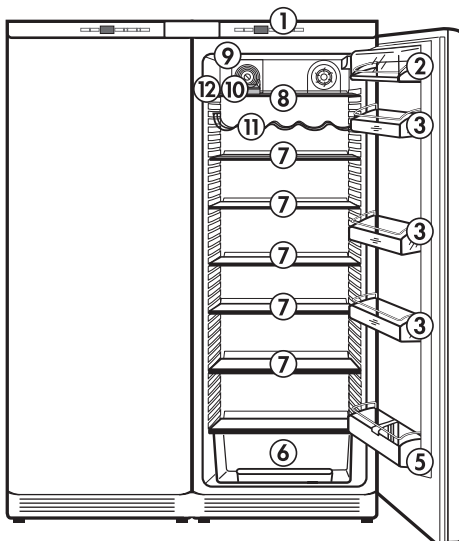

- ① Control panel
- ② Butter and cheese compartment with lid
- ③ Door storage compartments
- ⑤ Bottle compartment
- ⑥ Salad bin
- ⑦ Shelves
- ⑧ Quick chill shelf
- ⑨ Filter housing
- ⑩ Bottle and can holder
- ⑪ Bottle rack
- ⑫ Rating plate

Control Panel

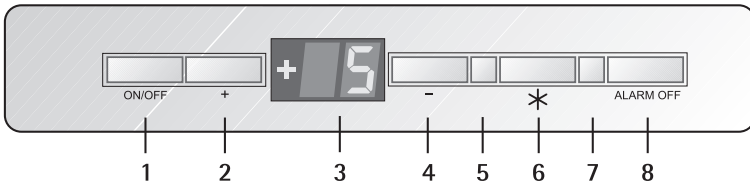

- 1 ON/OFF button
- 2 Button for adjusting the temperature (for warmer temperatures)
- 3 Temperature display
- 4 Button for adjusting the temperature (for colder temperatures)
- 5 COOLMATIC indicator light (yellow)
- 6 COOLMATIC button
- 7 Warning indicator light (red)
- 8 ALARM OFF button (see „Control- and Information Systems“)

Buttons for Adjusting the Temperature



The temperature is adjusted using the „+“ (WARMER) and „-“ (COLDER) buttons.

These buttons are connected to the temperature display.

- The temperature display is switched over from the display of the ACTUAL temperature (Temperature display is illuminated) to the display of the DESIRED temperature (Temperature display flashes) by pressing one of the two buttons, „+“ (WARMER) or „-“ (COLDER).
- Each time one of the two buttons is pressed again the DESIRED temperature is adjusted by 1 °C.
- If neither button is pressed, the temperature display automatically switches back after a short period (approx. 5 sec.) to the display of the ACTUAL temperature.

DESIRED temperature means:

The temperature that is required in the freezer compartment, this can be adjusted to the temperatures shown in the display. The DESIRED temperature is indicated by flashing numbers.

ACTUAL temperature means:

The temperature display indicates the temperature that is currently present in the freezer compartment. The ACTUAL temperature is indicated with illuminated numbers.

Temperature Display



The temperature display can indicate several pieces of information.

- During normal operation, the temperature currently present in the refrigerator (ACTUAL temperature) is displayed.
- When the temperature is being adjusted a flashing display indicates the fridge compartment temperature currently set (DESIRED temperature).
- If there is a fault in the appliance the temperature display shows a square in the temperature display for the fridge.

COOLMATIC button



The COOLMATIC function is suited for quick cooling of large quantities of goods in the refrigerator, e.g. drinks and salads for a party.

1. The COOLMATIC function is switched on by pressing the COOLMATIC button. The yellow light illuminates. The COOLMATIC function now provides for intensive cooling. A DESIRED temperature of +2 °C is automatically selected. The COOLMATIC function is ended automatically after a period of 6 hours. The originally selected DESIRED temperature is again valid. The temperature display shows the ACTUAL refrigerator temperature.
2. The COOLMATIC function can be ended manually at any time by pressing the COOLMATIC button again. The yellow light goes out.

Important! Once the COOLMATIC function has been switched on the DESIRED temperature that was set originally cannot be changed.

Quick chill

The quick chill function can be used for the fast cooling of drinks in cans or bottles in the fast cool storage tray or of larger amounts of room-temperature food. The built-in charcoal filter reduces the development of any smell.

Chilling of cans/bottles

Place cans or bottles in the holder on the quick chill shelf in front of the fan grille. Turn the fan regulator to maximum and press the COOLMATIC button. The yellow indicator light comes on.

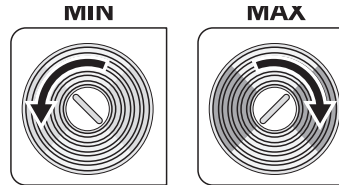

Chilling of food

Place the food in the fridge. Open the fan regulator to maximum and press the COOLMATIC button. The yellow indicator light comes on.

When the drinks or the food is sufficiently cooled, press the COOLMATIC button again. The yellow indicator light goes out. Set the fan regulator to the minimum position.



When this function has been activated, forced air will chill the groceries, and the temperature in the cabinet reset to +2 °C. After 6 hours the COOLMATIC function is ended automatically. The yellow light goes out. Turn the air regulator to its minimum position.

ALARM OFF button



With the ALARM OFF button, the acoustic warning signal can be switched off, e.g. the "Open Door" warning when sorting in or out, the food to be chilled.

Prior to Initial Start-Up



Before connecting the appliance to the mains and putting it into operation for the first time, leave the appliance to stand for 30 minutes if was transported upright. After transport on its side, the appliance must be left to stand for 2 hours before putting it into operation. This is necessary to allow the refrigerant to flow back into the compressor. Otherwise the compressor may be damaged.



1. Please clean the appliance interior and all accessories prior to initial start-up (see section: "Maintenance and Cleaning").
2. The appliance must be correctly installed in accordance with the chapter "Installation" before it is put into operation for the first time. Care should be especially taken that the mains voltage and frequency available correspond with the appliance's rating plate.

Initial Start-Up



1. Insert plug into mains socket.
2. Press ON/OFF button.
The compressor starts and then runs automatically.
3. Set temperature to +5 °C or colder (see section: "Temperature Adjustment").



Goods to be refrigerated can be loaded immediately after switching on, because the storage temperature in the refrigerator is quickly reached.

Temperature Adjustment

With the buttons for temperature adjustment the desired temperatures in the refrigerator can be adjusted.



1. Press either the „+“ (WARMER) or „-“ (COLDER) button.
The temperature display switches over and the DESIRED temperature currently set flashes on the temperature display.
2. To adjust to a warmer temperature, press the „+“ (WARMER) button. To adjust to a colder temperature, press the „-“ (COLDER) button. The changed setting is immediately displayed on the temperature display.

Each time the button is pressed the temperature is adjusted by 1 °C.
Adjustable temperature range: +2 °C to +8 °C, +15 °C (Holiday mode)

Note: From a food safety point of view, +5 °C for the refrigerator compartment should be considered cold enough as a storage temperature.

- i** When the buttons are not further pressed after an adjustment has been made, after a short period (approx. 5 sec.) the temperature display switches over and again displays the ACTUAL temperature in the refrigerator. The display changes from flashing to illuminated numbers.

Information! When the setting is changed, the compressor does not start immediately if automatic defrosting is currently taking place.

Switching the Appliance off

- ☞** 1. To switch off, push and hold the ON/OFF button for approx. 5 seconds. This will result in a countdown from "3" to "1" taking place in the temperature display. On reaching "1" the fridge will switch off. The temperature display will go off.

- i** The appliance is only completely disconnected from the electricity supply when the power plug has been removed from the power outlet.

Note:

The appliance cannot be switched on or off if unplugged, or if there is no power being supplied to it.

Following connection to the mains power supply, the appliance returns to the same operating state as before the interruption of main power.

If the appliance is not going to be used for an extended period:

- ☞** 1. Switch off the appliance, to do this press the ON/OFF button (see above).
2. Remove the mains plug.
 3. Clean the appliance thoroughly (see section: "Maintenance and Cleaning").
 4. Leave door open to avoid accumulation of odours.

Holiday Mode

In the holiday mode the temperature for the refrigerator is approximately +15 °C. In the holiday mode it is therefore possible to leave the door of the empty refrigerator closed during periods of extended absence. Advantage: Unintentional closing of the door, or accidental closing of the door by persons who have access to your home during your absence, is no longer possible. Without the holiday mode leaving the door closed would lead to the accumulation of odours and mould.

After emptying and cleaning the appliance, proceed as follows:

1. To set the holiday mode, press the „+“ (WARMER) or „-“ (COLDER) button.

The temperature display will change and indicate in flashing numbers the DESIRED temperature that is currently set.

2. Hold down the „+“ (WARMER) button until the temperature display indicates H (for holiday). The temperature shown in the temperature display will change in steps of 1 °C until it reaches +8 °C. After +8 °C the value +15 °C will appear in the display with the letter H. The fridge is now operating in energy-saving holiday mode.

-  To switch the fridge back to normal operation, press the „-“ (COLDER) button.

Important! Do not store any goods in the refrigerator when the holiday mode is in operation. The temperature is regulated at about +15 °C when the holiday mode is in operation. This is too warm for food products.

Opening the Door

If the door is closed when the appliance is in operation, it cannot be immediately opened again, because a vacuum occurs which holds the door closed until pressure has been equalised. The door can be opened again after several minutes.

Control and Information Systems

The control and information systems consist of the temperature display, an optical warning display and an acoustic warning.

The system warns if:

- if the appliance door remains open for longer than 5 minutes;
- if the temperature in the fridge compartment is too warm;
- functional errors at the appliance.

"Open Door" Warning

If the fridge door is left open for longer than 5 minutes the red warning display will flash and an acoustic warning tone will sound.

If you need more time to load or rearrange refrigerated foods, you can switch off the warning tone by pressing the ALARM OFF button.

The red warning display will go off when the door is closed.

Temperature warning

The red warning light flashes and a warning tone sounds, as soon as the temperature in the refrigerator is warmer than 12 °C. Such a rise in temperature can possibly be put down to:

- opening the door a lot or leaving it open for a long time;
- storing larger quantities of warm food;
- a fault with the appliance.

You can turn off the warning tone using the ALARM OFF button.

The warning light and the warning tone switch off automatically, when the ACTUAL temperature existing in the refrigerator drops below 12 °C again.

Function Errors

If the appliance electronics detects a technical fault that needs to be rectified by customer service, the temperature display shows a square in the upper part of the temperature display. The red warning indicator flashes. The appliance will continue to operate in emergency mode.

Interior Fittings

Storage Shelves

The shelf in the lowest runners over the fruit and vegetable drawer must always remain in this position, so that fruit and vegetables stay fresher for longer.

The remaining storage shelves can be adjusted to various heights:

 1. Pull the storage shelf forward until it can be tipped up or down and removed.

2. To insert at a different height use the same procedure in reverse. Adjustment for tall items:

 1. Remove the front half of the two-part vario glass storage shelf and insert it at a different level. Space is then gained for storage of tall items on the storage shelf below.



Variable Inner Door

The door compartments can be pulled up and removed, and inserted at other positions as needed.

Salad Bin

The salad bin can be divided into sections by inserting the dividers.

 1. Insert the large divider in the middle or to the left side of the salad bin as required.

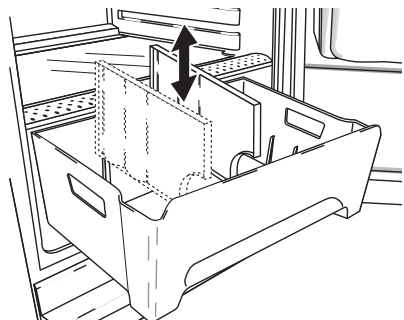

- i** The ventilation grille above the salad bin improves air circulation so that groceries keep for longer.

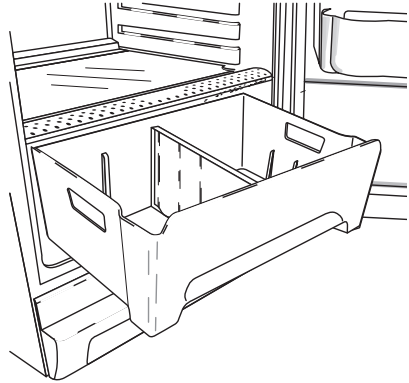

Bottle Rack

Place bottles in the rack with the bottleneck to the front.

Important: Only store unopened bottles horizontally.

The bottle rack can be tilted for storing opened bottles.

- 1.** To do this pull the bottle rack forward until it can be tilted upwards, then slide the front support into the next level up.

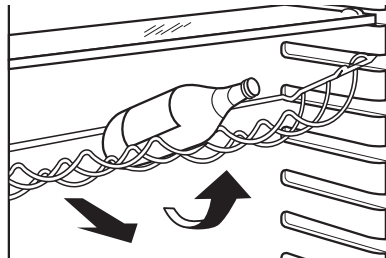
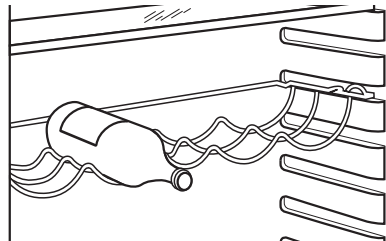

Quick Chill Shelf

The quick chill shelf can be placed in one of the upper grooves. To maintain the best performance the shelf should be placed in the second groove from the top.

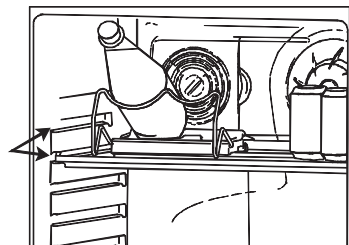

Bottle and Can Holder

The side of the bottle and can holder is moveable to enable a more flexible placement of cans and bottles in front of the grid. To allow the holder to be moved easier when moving sideways, press the shelf backwards.

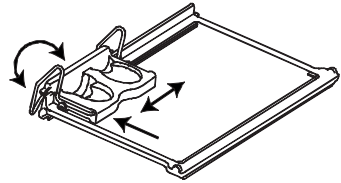

The bottle support can be pulled out when chilling larger bottles.

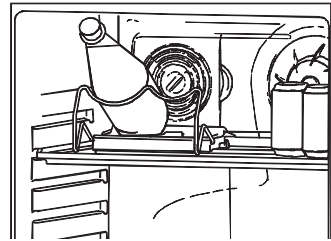

Dismantling of the Bottle and Can Holder

1. Take out the quick chill shelf with holder from the cabinet.
2. To loosen the holder from the shelf, bend the hooks/brackets that surround the backside of the shelf.

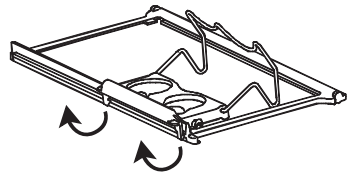

Bottle Holder

A bottle holder in the bottle compartment is used to prevent individual bottles from falling over and can be slid sideways.

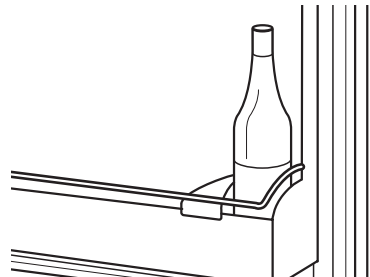

Proper Storage

The cooling fan ensures an even temperature distribution in the fridge. There is a max. temperature difference of 1 °C. Foods with different lengths of storage time can therefore be arranged on the shelves as you like, without having to take into account the different temperature zones which usually occur. The temperature in the fruit and vegetable drawer is around 3 - 4 °C higher than the fridge temperature set. The example arrangement opposite shows possible ways of storing food. The shelf immediately above the fruit and vegetable tray should be 5 °C for safe storage of meat and fish products. In order to check that the appliance is at 5 °C on the lowest shelf you can carry out the following test yourself:

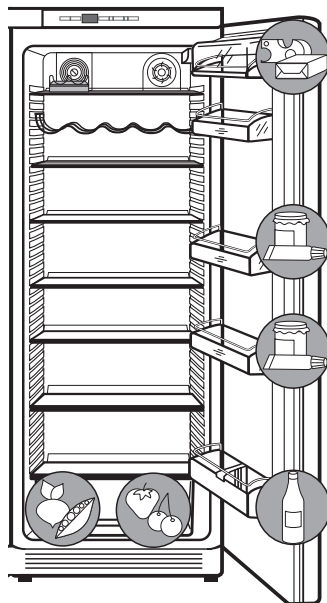

1. Place a cup of water in the centre of the said shelf with a thermometer inside.
2. Leave the fridge door closed overnight and check the temperature first thing in the morning.
3. At this point the temperature should read no more than 5 °C; if it does, you need to adjust the temperature to a colder setting.

For further information on keeping food cool and safe a guide published by the Ministry of Agriculture, Fisheries and Food is available and can be obtained free of charge by contacting:

Foodsense, London SE99 7TT. Tel: 0645 556000

Tip: Food stored in the refrigerator compartment should always be covered or packed so that they do not dry out, lose their flavour, or transfer their flavour to any other refrigerated food. The following are suitable for packing:

- polyethylene bags;
- plastic containers with lids;
- special plastic covers with rubber retainers;
- aluminium foil.

Hints and Tips

Normal Operating Sounds

- You may hear faint gurgling or bubbling sounds when the refrigerant is pumped through the coils or tubing at the rear, to the cooling plate/evaporator.
- When the compressor is on, the refrigerant is being pumped round and you will hear a whirring sound or pulsating noise from the compressor.
- A thermostat controls the compressor and you will hear a faint click when the thermostat cuts in and out.

Food Storage

To obtain the best performance from your refrigerator:

- Do not store warm food or evaporating liquids.
- Do not store food uncovered.
- Keep the time between buying chilled food and placing it in your refrigerator as short as possible.
- Do not push food together too much, try to allow air to circulate around each item.



Energy Saving Advice

- Do not install the appliance close to sources of heat, such as a cooker, dishwasher or radiator.
- Locate the appliance in a cool well ventilated room and make sure that the air openings of the appliance are not obstructed.
- Always leave warm food to cool down to room temperature before placing in the fridge.
- Try to avoid keeping the door open for long periods or opening the door too frequently as warm air will enter the cabinet and cause the compressor to switch on unnecessarily often.
- Ensure there are no obstructions preventing the door from closing properly.

Defrosting

The Fridge defrosts automatically

Maintenance and Cleaning

Before any maintenance or cleaning work is carried out **DISCONNECT** the appliance from the **ELECTRICITY** supply.

Internal Cleaning

-  1. Clean the inside and accessories with warm water and bicarbonate of soda (5 ml to 0.5 litre of water). Rinse and dry thoroughly.



Warning!

- Do not use detergents, abrasive powders, highly perfumed cleaning products, wax polishes or cleaning products containing bleach or alcohol.
2. Regularly check the door seals and wipe clean to ensure they are clean and free from debris.

External Cleaning



Warning!

- Do not use abrasive products
- There are sharp edges on the underside of the product so care should be taken when cleaning.



Important: Do not use cleaning agents for stainless steel or other aggressive or abrasive cleaning agents. The protective coat of lacquer on the stainless steel surface can be damaged by these.

The coat of lacquer protects against finger prints and therefore additional cleaning agents and maintenance products are no longer required.

-  1. Clean the appliance with a cloth and lukewarm water. Commercially available dish washing detergents may also be used. Rinse and dry thoroughly.



Accumulation of dust at the condenser reduces cooling performance and increases energy consumption. For this reason carefully clean the condenser at the back of the appliance once a year with a soft brush or a vacuum cleaner.

2. After everything is dry place appliance back into service.

Changing the carbon filter

To maintain the best performance the carbon filter should be changed once a year with normal usage.

New carbon filters can be purchased from your local Service Force Centre.

1. The filter is placed behind the grill and can be reached by opening the cover. The cover can be opened by simultaneously pressing the lever on the right of the grill (1) and pulling the cover outward (2).
2. The carbon filter is then pulled out of its slot (3).
3. The new carbon filter is placed in the existing slot.

 The filter should be handled carefully so fragments do not loosen from the surface.

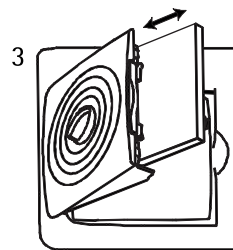
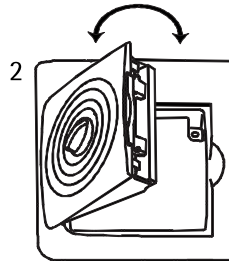
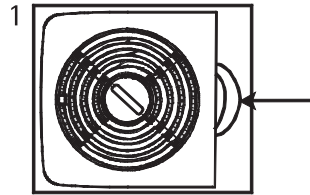

Replacing the Light Bulb

 **Warning!** Danger of electrical shock! Before replacing the light bulb switch appliance off and remove the mains plug.

Light bulb specifications: 220-240 V, max. 25 W, fitting: E 14

Important!

When replacing the lamp only fit a lamp of suitable diameter, that is at least 18 mm, this will ensure a good seat on the rubber seal.

Where to purchase: specialist retailer or AEG Service Force Centre.



1. To switch the appliance off press and hold the ON/OFF button.
2. Unplug the mains plug.
3. To change the light bulb, undo the cross head screw and remove the light bulb cover downwards.
4. Change the defective light bulb.
5. Refit the light bulb cover and the cross head screw.

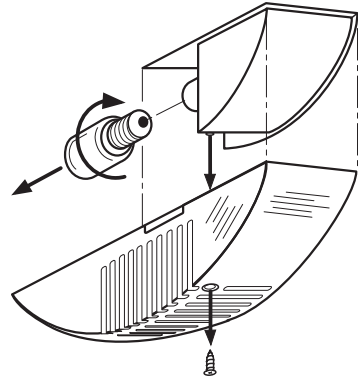

What to do if ...

Before contacting your local Service Force Centre, check the following points.

Symptom	Solution
No power to the appliance.	Check there is power at the socket
	Check there is not a power cut by checking the household lights.
	Check the fuse has not blown.
Appliance cools too much.	Temperature is set too cold. Set the temperature to a warmer setting temporarily.
The temperature in the refrigerator is too high.	Check the ambient temperature is within the appliances operating limits
	Check the temperature regulator is turned to the correct setting relative to ambient conditions.
Warning tone sounds, red warning display is flashing	Door is opened for longer than 5 minutes Switch off the warning tone by pressing the ALARM OFF button. Do not leave the door open for longer than necessary.

Symptom	Solution
Red warning light flashing, warning tone sounding	Temperature warning Please look at "Temperature warning" section.
Temperature display shows a square.	There is a function fault. Please inform your local Service Force Centre. Do not open the door of the appliance again.
The compressor runs continuously	Adjust the temperature regulator to give correct temperature control.
	Check that the door is closed.
	Large quantities of food have recently been placed in the cabinet and/or door is frequently opened.
	Check that air ventilation is not obstructed.
The light does not come on.	Ensure the bulb is correctly fitted.
	Replace the bulb if it has blown.
	Check the door light switch is not jammed.
Water on the floor or on storage shelves.	Water drain hole is blocked. See the "Cleaning and Maintenance" section.
Noise	Refer to Normal Operating Sounds
The compressor does not start immediately after changing the temperature setting.	This is normal, the compressor starts after a period of time.

If after the above checks there is still a fault, call your local AEG Service Force Centre.

In-guarantee customers should ensure that the above checks have been made as the engineer will make a charge if the fault is not a mechanical or electrical breakdown.

Please note that proof of purchase is required for in-guarantee service calls.

Regulations, Standards, Guidelines

This appliance was designed for household use and was manufactured in accordance with the appropriate standards. The necessary measures in accordance with appliance safety legislation regulations (GSG), accident prevention regulations for refrigeration appliances (VBG 20) and the regulations of the German Society of Electrical Engineers (VDE) were observed in the manufacture of this appliance. The refrigerant circuit has been checked for leaks.

- CE This appliance is in accordance with the following EU guidelines:
- 73/23/EEG dated 19 February 1973 - low voltage guidelines.
 - 89/336/EEG dated 3 May 1989 (including guideline change notice 92/31/EEG) - EMV guideline

Technical Terminology

• Refrigerant

Liquids that can be used to generate a cooling effect are known as refrigerants. They have a relatively low boiling-point, indeed so low, that the warmth from the food stored in the fridge or freezer can cause the refrigerant to boil and vaporise.

• Refrigerant Circuit

Closed circulation system that contains the refrigerant. The refrigerant circuit comprises primarily of an evaporator, a compressor, a condenser and pipe work.

• Evaporator

The refrigerant is evaporated in the evaporator. Similar to all other liquids, refrigerant requires heat to evaporate. This heat is removed from the interior of the appliance, as a result the interior is cooled. The evaporator is therefore located inside the appliance or placed in foam immediately behind the inner wall and thus not visible.

• Compressor

The compressor looks like a small drum. It is driven by a built-in electric motor and is mounted on the base of the appliance at the rear. The task of the compressor is to draw in vaporised refrigerant from the evaporator, to compress it, and to pass it on to the condenser.

• Condenser

The condenser normally has the form of a grid. The refrigerant compressed in the compressor is liquefied in the condenser. During this process, heat is released to the surrounding air at the surface of the condenser. The condenser is mounted on the base of the appliance.

Guarantee Conditions

Standard Guarantee Conditions

We, AEG-Electrolux, undertake that if within 12 months of the date of the purchase this AEG-Electrolux appliance or any part thereof is proved to be defective by reason only of faulty workmanship or materials, we will, at our discretion repair or replace the same FREE OF CHARGE for labour, materials or carriage on condition that:

- The appliance has been correctly installed and used only on the electricity or gas supply stated on the rating plate.
- The appliance has been used for normal domestic purposes only, and in accordance with the manufacturer's operating and maintenance instructions.
- The appliance has not been serviced, maintained, repaired, taken apart or tampered with by any person not authorised by us.
- All service work under this guarantee must be undertaken by a Service Force Centre. Any appliance or defective part replaced shall become the Company's property.
- This guarantee is in addition to your statutory and other legal rights.
- Home visits are made between 8.30am and 5.30pm Monday to Friday. Visits may be available outside these hours in which case a premium will be charged.

Exclusions

This guarantee does not cover:

- Damage or calls resulting from transportation, improper use or neglect, the replacement of any light bulbs or removable parts of glass or plastic.
- Costs incurred for calls to put right an appliance which is improperly installed or calls to appliances outside the United Kingdom.
- Appliances found to be in use within a commercial environment, plus those which are subject to rental agreements.
- Products of AEG-Electrolux manufacture which are not marketed by AEG-Electrolux.

European Guarantee

If you should move to another country within Europe then your guarantee moves with you to your new home subject to the following qualifications:

- The guarantee starts from the date you first purchased your product.
- The guarantee is for the same period and to the same extent for labour and parts as exists in the new country of use for this brand or range of products.
- This guarantee relates to you and cannot be transferred to another user.
- Your new home is within the European Community (EC) or European Free Trade Area.
- The product is installed and used in accordance with our instructions and is only used domestically, i.e. a normal household.
- The product is installed taking into account regulations in your new country.

Before you move please contact your nearest Customer Care centre, listed below, to give them details of your new home. They will then ensure that the local Service Organisation is aware of your move and able to look after you and your appliances..

France	Senlis	+33 (0) 3 44 62 29 29
Germany	Nürnberg	+49 (0) 800 234 7378
Italy	Pordenone	+39 (0) 800 117511
Sweden	Stockholm	+46 (0) 8 672 5360
UK	Luton	+44 (0) 8705 350 350

Service & Spare Parts

In the event of your appliance requiring service, or if you wish to purchase spare parts, please contact Service Force by telephoning:

08705 929 929

Your telephone call will be automatically routed to the Service Force Centre covering your post code area.

For the address of your local Service Force Centre and further information about Service Force, please visit the website at www.serviceforce.co.uk

Before calling out an engineer, please ensure you have read the details under the heading „What to do if....“

When you contact the Service Force Centre you will need to give the following details:

1. Your name, address and post code.
2. Your telephone number
3. Clear and concise details of the fault.
4. The model and serial number of the appliance (found on the rating plate).

• Model Name



• Model Number (PNC)



• Serial Number (S-No.)



5. The purchase date

Please note that a valid purchase receipt or guarantee documentation is required for in-guarantee service calls.

Customer Care

For general enquiries concerning your AEG-Electrolux appliance, or for further information on AEG-Electrolux products please contact our Customer Care Department by letter or telephone at the address below or visit our website at www.aeg-electrolux.co.uk.

Customer Care Department
Major Appliances
AEG-Electrolux
Domestic Appliances
Addington Way
Luton
Bedfordshire, LU4 9QQ
Tel: 08705 350350 (*)

For Customer Service in the Republic of Ireland please contact us at the address below:
AEG/ Electrolux Group (Ire) Ltd
Long Mile Road/ Dublin 12
Republic of Ireland
Tel: +353 (0) 1 4090754
Email: service.eid@electrolux.ie

(*) Calls may be recorded for training purposes

www.electrolux.com

AEG Hausgeräte GmbH
Postfach 1036
D-90327 Nürnberg

<http://www.aeg.hausgeraete.de>

© Copyright by AEG

818 35 69 – 02/2 - 0907

Subject to change without notice

Free Manuals Download Website

<http://myh66.com>

<http://usermanuals.us>

<http://www.somanuals.com>

<http://www.4manuals.cc>

<http://www.manual-lib.com>

<http://www.404manual.com>

<http://www.luxmanual.com>

<http://aubethermostatmanual.com>

Golf course search by state

<http://golfingnear.com>

Email search by domain

<http://emailbydomain.com>

Auto manuals search

<http://auto.somanuals.com>

TV manuals search

<http://tv.somanuals.com>