

Addonics

TECHNOLOGIES

Storage Tower

ST4IDEU2, ST4SAML, ST5X1PM, ST5XHPM,
ST4US, ST4ESA, ST6ESA, ST5ESAIUS, STMPC, STBTO
ST4IDEU2-B, ST4SAML-B, ST5X1PM-B, ST5XHPM-B,
ST4US-B, ST4ESA-B, ST6ESA-B, ST5ESAIUS-B, STMPC-B

User's Guide

Version 1.0

FCC Warning Statement

This equipment has been tested and found to comply with the limits for a class B digital device pursuant to Part 15 of the FCC rules. These limits are designed to provide reasonable protection against harmful interference in a residential installation. This equipment generates, uses and can radiate radio frequency energy. If not installed and used in accordance with the instructions, it may cause harmful interference to radio communications. However, there is no guarantee that interference will not occur in a particular installation. If the equipment does cause harmful interference to radio or television reception, which can be determined by turning the equipment on and off, the user is encouraged to try and correct the interference by one or more of the following suggestions.

Reorient or relocate the receiving antenna

Increase the distance between the equipment and the receiver

Connect the equipment to a different power outlet other than the one where receiver is connected

Consult a certified television or radio technician

Storage Tower Overview

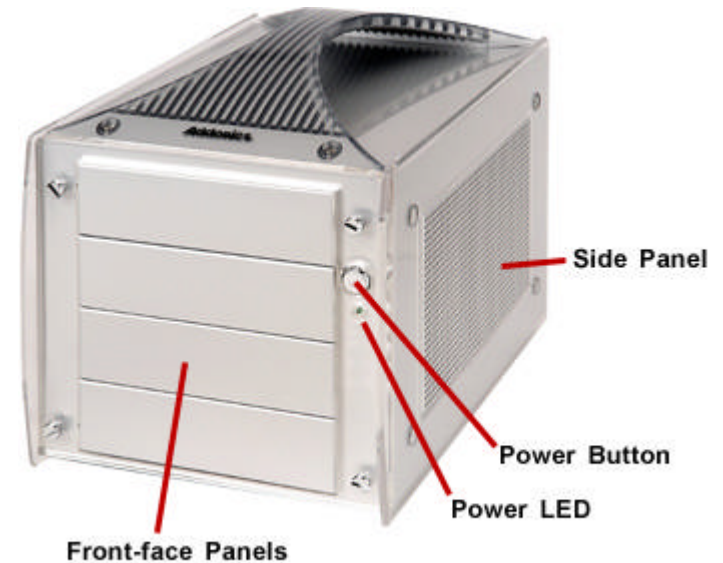

Model: **ST6ESA**

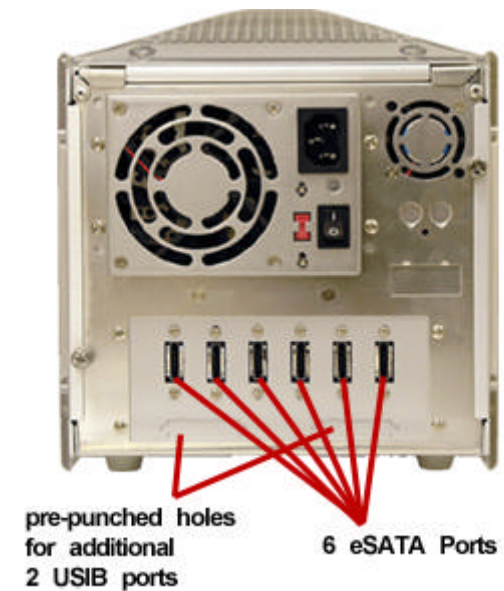

Model: **ST4US**



pre-punched holes
for additional
2 eSATA ports

4 USB
ports

Model: **ST4IDEU2**



JBOD
USB 2.0
Adapter

pre-punched holes
for additional
2 eSATA and
1 USB ports

Model: **ST5X1PM**



eSATA port from
Port Multiplier
or Multilane
connector

pre-punched holes
for additional
2 eSATA and
1 USB ports

Storage Tower Preparation



- Remove the side panel screws.
- Slide the side panel towards the backside then pull or lift to open.
- To remove the front face panels, unscrew 2 screws on opposite sides of the 5 ¼" drive bay on the tower



- This picture shows the storage tower without both the side panels and front faceplate.

Sample Installation on the tower using IDE hard drives

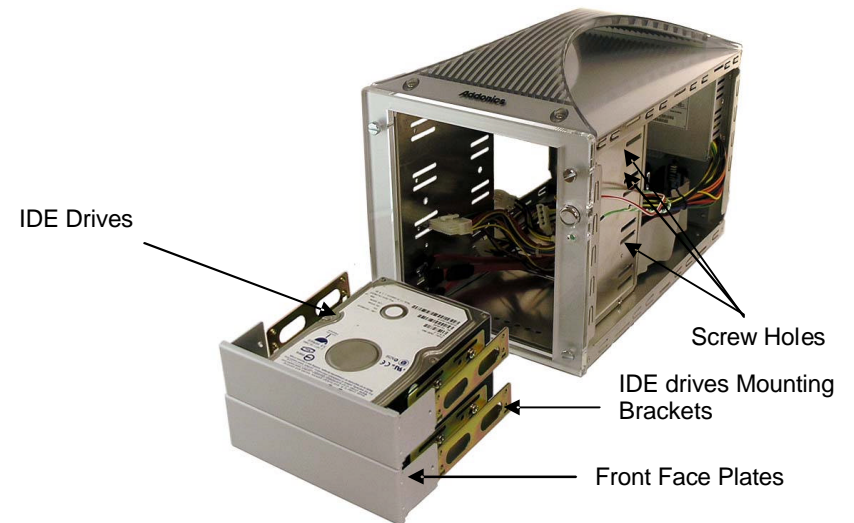

- Make sure that screws are placed for both sides of the mounting bracket to secure the drives.

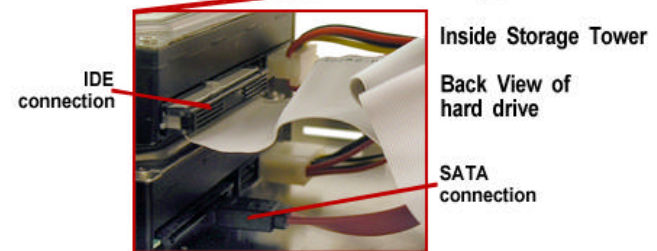
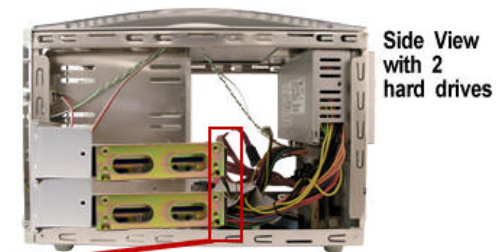

- After installing the hard drive, attach the side panels back to the storage tower.

Tower with USIB connector

- Any IDE or ATAPI Storage device can be converted to USB or Firewire connection via the Addonics USIB interface board and USIB interface cable.
- IDE and ATAPI drives must be set as Master device.

USIB back panel



Inside of the USIB back panel

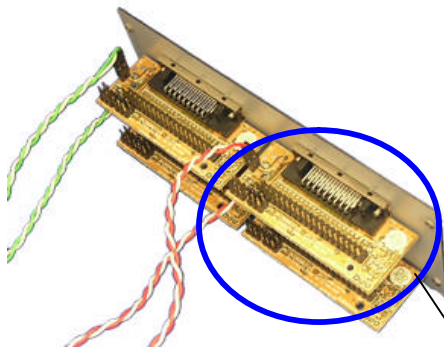

IDE Device Installation to the USIB Connector

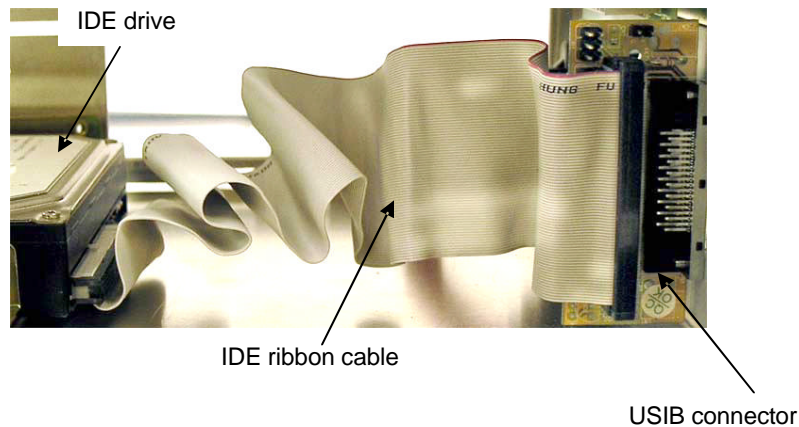

The USIB setup can do hot swap when Addonics mobile racks are used

- When using an Addonics mobile rack, make sure that the power from the USIB board is connected to the power input from the cradle. The power to the Addonics cradle can only go one way.

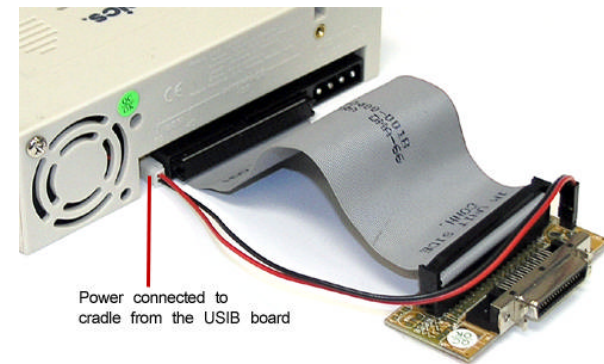
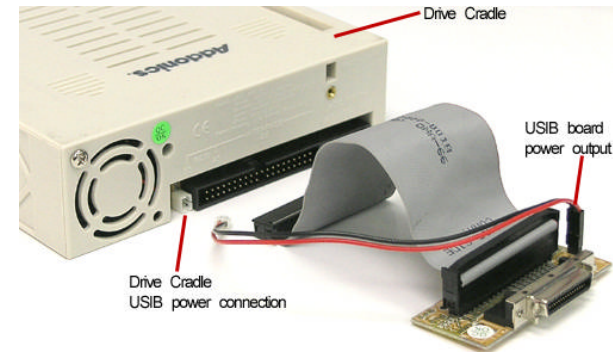

- For USB2 connection, attach the Addonics USB2.0 USIB interface cable to the USIB connector.
- For Firewire connection, attach the Addonics Firewire USIB interface cable to the USIB connector.
- When non-Addonics mobile rack is used. The Storage Tower can be powered down and restarted to swap out hard drive without rebooting the system when using USB or Firewire interface.
- To un-mount the drive from the computer using a non-Addonics mobile rack the USIB cable must detach from the back of the Storage Tower or the Storage Tower power must be power off to un-mount the drive from the computer. The drive will not be hot swappable by turning the switch on and off from the front of the mobile rack.

Tower with eSATA connector

For SATA connection, hot swap feature depends on the controller. All Addonics SATA controllers support the hot swap feature.

eSATA and USIB back panel



Inside the Tower

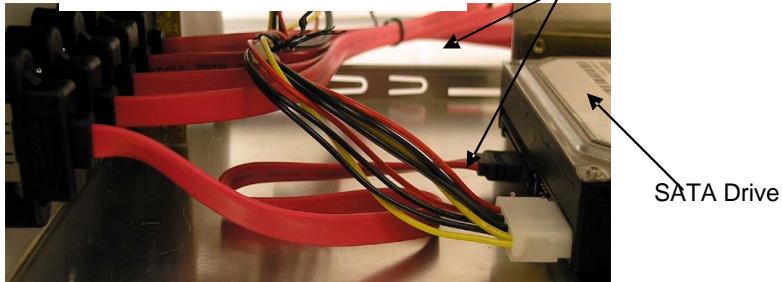

Back of Tower

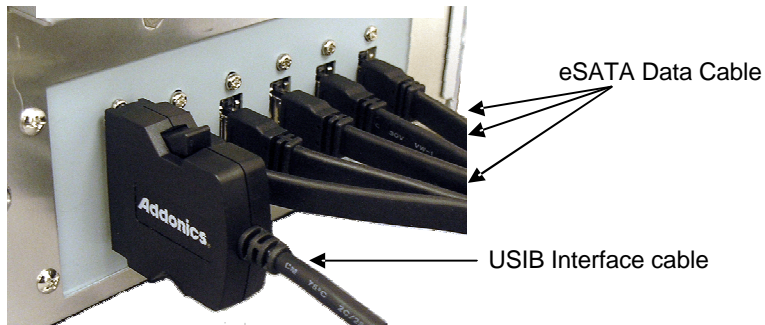

Tower with Port Multiplier

Hot swap feature depends on the SATA controller. All Addonics SATA controllers support the hot swap feature. Port Multiplier does not work with SATA controller that has no PM support. Check with your system supplier to confirm the PM support on your existing SATA port



eSATA port from Port Multiplier

pre-punched holes for additional 2 eSATA and 1 USB ports

PCB view

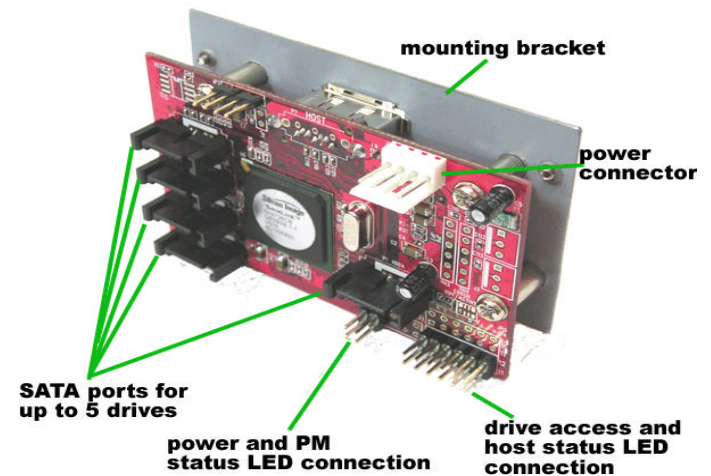

Tower with Hardware Port Multiplier

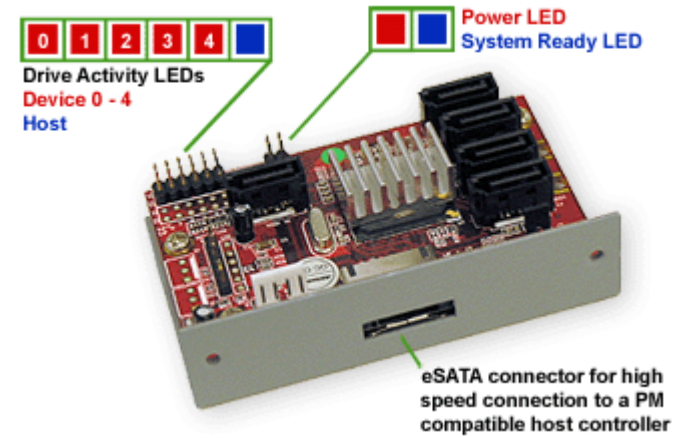
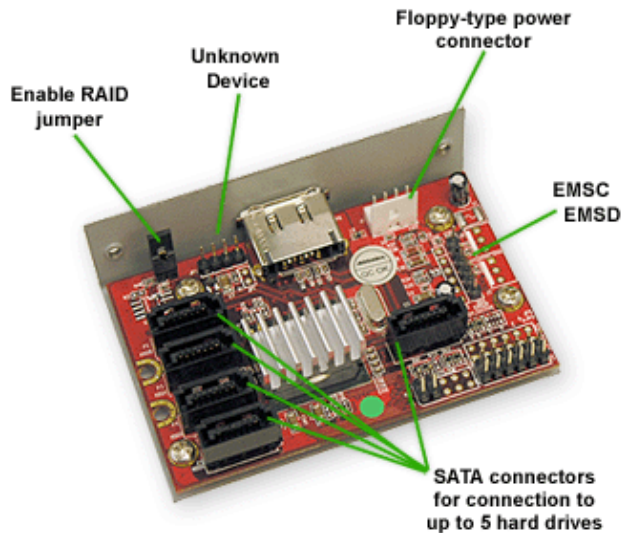

Note: You need to install the *Sil4726 Manager* on your system to configure RAID sets.

RAID configuration is programmed by connecting the hardware port multiplier:

- to one of Addonics' SATA controllers that has SIL3124 or SIL3132 chip set.
- via USB 2.0 connection (optional Addonics eSATA-USB adapter is required)

After RAID configuration, it is compatible with any SATA controller (RAID or non RAID)

Software Installation for *Sil4726 Manager*

- A. From the CD start-up menu select SATA RAID Utilities > Other SATARAID Utilities > Windows 2000/XP/2003/Vista.
- B. Unzip the file *Sil_4726_Manager_V4.0.0.9.zip* on your drive. The folder name would be *Sil4726*.
- C. To install *Sil4726 Manager*, double click *setup.exe*

In *Sil4726 Manager*, all the drives connected to the AD5SAHPM-E will show up.

For a complete User's Guide of *Sil4726* refer to our website.
Support > User Guides > *Sil4726 Manager* User Manual V.26

Tower with Multilane Connector

Hot swap feature depends on the SATA controller. All Addonics SATA controllers support the hot swap feature. Check with your system supplier to confirm the existing SATA port on your system supports hot swap feature.

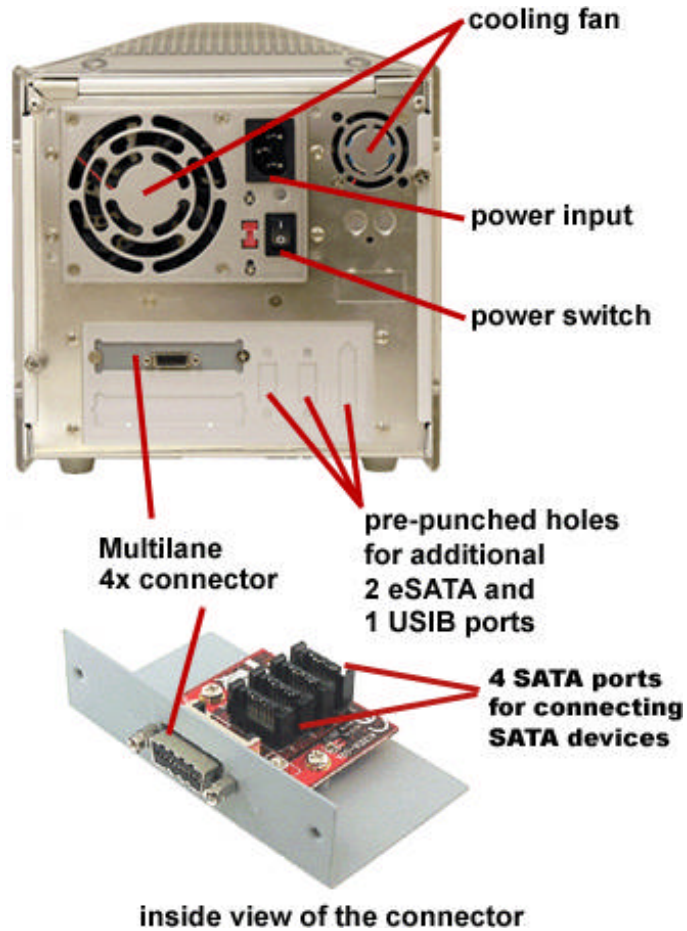

Tower with JBOD USB 2.0 Adapter

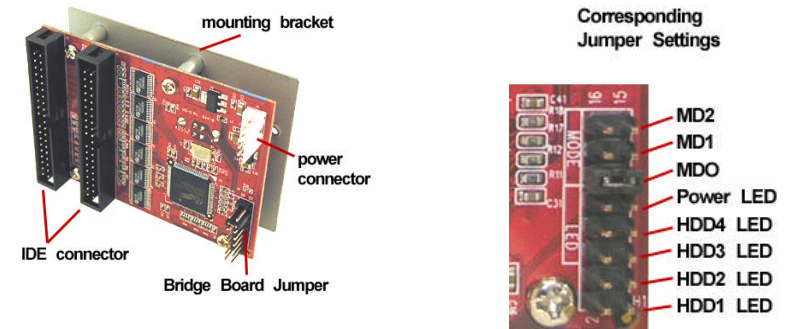
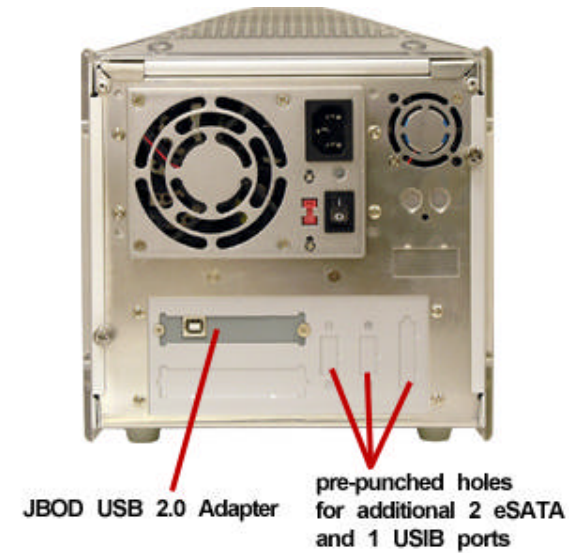

Note: It is important that you have configured your Multilane Host controller before connecting it to the tower.

MODE #	MODE	Description
MD2	2 HDD Mode	ON: Combines P1 (two disk drives as one large disk drive) and combines P3 (two disk drives as another entire disk drive)
MD1	1 HDD Mode	ON: Combines 4 disk drives as one large disk drive
MD0	4 HDD Mode	ON: Separate 4 hard drives

Important

- o IDE drive settings must be set to one MASTER and one SLAVE if two drives will be connected on a single IDE ribbon.
- o Connect the MASTER drive at the end of the cable and the SLAVE drive at the middle.

Technical Support

If you need assistance to get your unit functioning properly, please call Addonics Technical Support. Our technical staff will be happy to assist you, but they will need your help to do so. Calling the technical support staff without all the proper information can be both time consuming and frustrating. Here are some tips to help you out:

MODEL NUMBER – Please have this number on hand.
SYSTEM INFORMATION – Type of computer, peripherals, etc.
OPERATING SYSTEM – What version of Windows
WHAT'S THE TROUBLE? – Give enough information
about your problem so that we can recreate and diagnose it.

**FREE Software Drivers for all Addonics Technologies
Products are available 24 hours per day at the
World Wide Web Site: www.addonics.com.**

Contact Information

Phone: 408-433-3899
Fax: 408-433-3898
Email: <http://www.addonics.com/sales/query/>
Internet: <http://www.addonics.com>

TECHNICAL SUPPORT

Phone: 408-433-3855
Hours: 8:30 am - 6:00 pm PST
Email: <http://www.addonics.com/support/query/>

Free Manuals Download Website

<http://myh66.com>

<http://usermanuals.us>

<http://www.somanuals.com>

<http://www.4manuals.cc>

<http://www.manual-lib.com>

<http://www.404manual.com>

<http://www.luxmanual.com>

<http://aubethermostatmanual.com>

Golf course search by state

<http://golfingnear.com>

Email search by domain

<http://emailbydomain.com>

Auto manuals search

<http://auto.somanuals.com>

TV manuals search

<http://tv.somanuals.com>