

AIMB-760

Socket LGA 775
Intel® Pentium® 4 / Celeron® D
800 MHz FSB
Industrial ATX Motherboard
with PCI-E/DDR2/Dual GbE

User Manual

Copyright

This document is copyrighted, 2006, by Advantech Co., Ltd. All rights are reserved. Advantech Co., Ltd. reserves the right to make improvements to the products described in this manual at any time without notice.

No part of this manual may be reproduced, copied, translated or transmitted in any form or by any means without the prior written permission of Advantech Co., Ltd. Information provided in this manual is intended to be accurate and reliable. However, Advantech Co., Ltd. assumes no responsibility for its use, nor for any infringements upon the rights of third parties which may result from its use.

Acknowledgements

- AWARD is a trademark of Phoenix Technologies Ltd.
- IBM and PC are trademarks of International Business Machines Corporation.
- Intel®, Pentium® 4, and Celeron® D are trademarks of Intel Corporation.
- WinBond is a trademark of Winbond Corporation.
- All other product names or trademarks are the properties of their respective owners.

Part No. 2002076001 2nd Edition
Printed in Taiwan February 2006

A Message to the Customer

Advantech Customer Services

Each and every Advantech product is built to the most exacting specifications to ensure reliable performance in the harsh and demanding conditions typical of industrial environments. Whether your new Advantech equipment is destined for the laboratory or the factory floor, you can be assured that your product will provide the reliability and ease of operation for which the name Advantech has come to be known.

Your satisfaction is our primary concern. Here is a guide to Advantech's customer services. To ensure you get the full benefit of our services, please follow the instructions below carefully.

Technical Support

We want you to get the maximum performance from your products. So if you run into technical difficulties, we are here to help. For the most frequently asked questions, you can easily find answers in your product documentation. These answers are normally a lot more detailed than the ones we can give over the phone.

So please consult this manual first. If you still cannot find the answer, gather all the information or questions that apply to your problem, and with the product close at hand, call your dealer. Our dealers are well trained and ready to give you the support you need to get the most from your Advantech products. In fact, most problems reported are minor and are able to be easily solved over the phone.

In addition, free technical support is available from Advantech engineers every business day. We are always ready to give advice on application requirements or specific information on the installation and operation of any of our products.

Certifications

FCC

This device complies with the requirements in part 15 of the FCC rules: Operation is subject to the following two conditions:

- This device may not cause harmful interference
- This device must accept any interference received, including interference that may cause undesired operation

This equipment has been tested and found to comply with the limits for a Class A digital device, pursuant to Part 15 of the FCC Rules. These limits are designed to provide reasonable protection against harmful interference when the equipment is operated in a commercial environment. This equipment generates, uses, and can radiate radio frequency energy and, if not installed and used in accordance with the instruction manual, may cause harmful interference to radio communications. Operation of this device in a residential area is likely to cause harmful interference in which case the user will be required to correct the interference at his/her own expense. The user is advised that any equipment changes or modifications not expressly approved by the party responsible for compliance would void the compliance to FCC regulations and therefore, the user's authority to operate the equipment.

Caution! *There is a danger of a new battery exploding if it is incorrectly installed. Do not attempt to recharge, force open, or heat the battery. Replace the battery only with the same or equivalent type recommended by the manufacturer. Discard used batteries according to the manufacturer's instructions.*

Memory Compatibility

Table 1.1: AIMB-760 Memory Tested for Compatibility

Brand	Size	Speed	Type	Memory
Apacer	1 GB	DDR2 533	DDR2	SAMSUNG K4T51083QB-ZKD5
UG	512 MB	DDR2 400	DDR2	4WB42 D9CHL
	1 GB	DDR2 400	DDR2	ELPIDA E5108AB-5C-E
Transcend	256 MB	DDR2 533	DDR2	SAMSUNG 443 K4T56083QF-GC05
	512 MB	DDR2 533	DDR2	ELPIDA E5108AB-5C-E
	1 GB	DDR2 533	DDR2	ELPIDA E5108AB-5C-E
DSL	512 MB	DDR2 533	DDR2	HYB18T512 800AF37 FSS43331 0440
	1 GB	DDR2 533	DDR2	ELPIDA E5108AE-5C-E

Network Feature Comparison

Table 1.2: AIMB-760 comparison table

LAN/Model	AIMB-760G2-00A1	AIMB-760G2-00A1
LAN1: Broadcom BCM5721	Yes	Yes
LAN2: Broadcom BCM5721	Yes	No

Product warranty

Advantech warrants to you, the original purchaser, that each of its products will be free from defects in materials and workmanship for two years from the date of purchase.

This warranty does not apply to any products which have been repaired or altered by persons other than repair personnel authorized by Advantech, or which have been subject to misuse, abuse, accident or improper installation. Advantech assumes no liability under the terms of this warranty as a consequence of such events.

If an Advantech product is defective, it will be repaired or replaced at no charge during the warranty period. For out-of-warranty repairs, you will be billed according to the cost of replacement materials, service time and freight. Please consult your dealer for more details.

If you think you have a defective product, follow these steps:

1. Collect all the information about the problem encountered. (For example, type of PC, CPU speed, Advantech products used, other hardware and software used, etc.) Note anything abnormal and list any on-screen messages you get when the problem occurs.
2. Call your dealer and describe the problem. Please have your manual, product, and any helpful information readily available.
3. If your product is diagnosed as defective, obtain an RMA (return material authorization) number from your dealer. This allows us to process your return more quickly.
4. Carefully pack the defective product, a fully-completed Repair and Replacement Order Card and a photocopy proof of purchase date (such as your sales receipt) in a shippable container. A product returned without proof of the purchase date is not eligible for warranty service.
5. Write the RMA number visibly on the outside of the package and ship it prepaid to your dealer.

Initial Inspection

Before you begin installing your motherboard, please make sure that the following materials have been shipped:

- AIMB-760 Pentium® 4 / Celeron® D processor based industrial motherboard
- 1 AIMB-760 startup manual
- 1 CD with driver utility and manual
- 1 FDD cable P/N: 1700340640
- 1 Ultra ATA 66/100 HDD cable P/N: 1701400452
- 2 Serial ATA HDD data cable P/N: 1700071000
- 2 Serial ATA HDD power cable P/N: 1703150102
- 1 ATX 12V power converter cable P/N: 170304015K
- 1 COM port cable kit P/N: 1701090401
- 1 I/O port bracket P/N: 1960004027
- 1 jumper package P/N: 9689000068
- 1 warranty card P/N: 2190000902

If any of these items are missing or damaged, contact your distributor or sales representative immediately. We have carefully inspected the AIMB-760 mechanically and electrically before shipment. It should be free of marks and scratches and in perfect working order upon receipt. As you unpack the AIMB-760, check it for signs of shipping damage. (For example, damaged box, scratches, dents, etc.) If it is damaged or it fails to meet the specifications, notify our service department or your local sales representative immediately. Also notify the carrier. Retain the shipping carton and packing material for inspection by the carrier. After inspection, we will make arrangements to repair or replace the unit.

Contents

Chapter 1	Hardware Configuration	2
1.1	Introduction	2
1.2	Features	3
1.3	Specifications	3
1.3.1	System.....	3
1.3.2	Memory.....	4
1.3.3	Input/Output.....	4
1.3.4	Ethernet LAN.....	5
1.3.5	Industrial features	5
1.3.6	Mechanical and environmental specifications.....	5
1.4	Jumpers and Connectors.....	6
	Table 1.1:Jumpers.....	6
	Table 1.2:Connectors.....	6
1.5	Board Layout: Jumper and Connector Locations.....	8
	Figure 1.1:Jumper and Connector locations	8
	Figure 1.2:I/O Connectors	9
1.6	AIMB-760 Block Diagram.....	10
	Figure 1.3:AIMB-760 Block Diagram.....	10
1.7	Safety Precautions	11
1.8	Jumper Settings	12
1.8.1	How to set jumpers	12
1.8.2	CMOS clear (J1).....	12
	Table 1.3:CMOS (J1).....	12
1.8.3	Watchdog timer output (J2)	13
	Table 1.4:Watchdog timer output (J2).....	13
	Table 1.5:ATX/AT Mode selector (J12).....	13
1.9	System Memory	14
1.9.1	CPU FSB and memory speed	14
1.10	Memory Installation Procedures	14
1.11	Cache Memory	14
1.12	Processor Installation	15
1.13	PCI Bus Routing Table	16
	Table 1.6:PCI Bus Routing Table.....	16
	Table 1.7:1U PCI Riser Card PCI Bus Routing Table .	16
	Table 1.8:2U PCI Riser Card PCI Bus Routing Table .	16
Chapter 2	Connecting Peripherals	18
2.1	Introduction	18
2.2	Primary (CN1) IDE Connector	18
2.3	Floppy Drive Connector (CN3).....	19
2.4	Parallel Port (CN4).....	20

2.5	USB Ports (CN6, CN63, CN31, CN32).....	20
	Figure 2.1:USB Ports.....	20
2.6	VGA Connector (CN7).....	21
2.7	Serial Ports (COM1:CN9; COM2:CN10).....	21
2.8	PS/2 Keyboard and Mouse Connector (CN11).....	22
2.9	External Keyboard & Mouse (CN12).....	23
2.10	CPU Fan Connector (CN14).....	23
2.11	System FAN Connector (CN15 and CN37).....	24
2.12	Front Panel Connectors (CN16, 17, 18, 19, 21&29).....	24
	2.12.1 Power LED and Keyboard Lock (CN16).....	25
	Table 2.1:PS/2 or ATX power supply LED status.....	25
	2.12.2 External Speaker (CN17).....	25
	2.12.3 Reset Connector (CN18).....	25
	2.12.4 HDD LED Connector (CN19).....	25
	2.12.5 ATX Soft Power Switch (CN21).....	26
	2.12.6 SM Bus Connector (CN29).....	26
2.13	H/W Monitor Alarm (CN22).....	26
2.14	USB and LAN ports (CN31 and CN32).....	27
2.15	Line Out, Mic In Connector (CN55).....	28
2.16	Audio Input from CD-ROM (CD IN; CN56).....	28
2.17	Aux Line-In Connector (AUX IN; CN57).....	29
2.18	Front Panel Audio Connector (FP AUDIO; CN59).....	29
2.19	8-pin Alarm Board Connector (CN62).....	30
2.20	Case Open Connector (CN64).....	30
2.21	Front Panel LAN Indicator Connector.....	31
	Table 2.2:Front Panel LAN Indicator Connector.....	31
2.22	Serial ATA Interface (SA0, SA1, SA2, SA3).....	32
2.23	PCI Slots (PCI 1 ~ PCI 5).....	33
2.24	Connecting to SNMP-1000 Remote Manager.....	33
2.25	Auxiliary 4-pin power connector (ATX1).....	34

Chapter 3 Award BIOS Setup.....36

3.1	Introduction.....	36
	3.1.1 CMOS RAM Auto-backup and Restore.....	36
3.2	Entering Setup.....	36
	Figure 3.1:Award BIOS Setup initial screen.....	37
3.3	Standard CMOS Setup.....	37
	3.3.1 Date.....	37
	3.3.2 Time.....	37
	3.3.3 IDE channel 0/1 Master/Slave.....	37
	3.3.4 Drive A / Drive B.....	38
	3.3.5 Halt On.....	38
	3.3.6 Memory.....	38
	Figure 3.2:Standard CMOS Features Screen.....	38

3.4	Advanced BIOS Features.....	39
	Figure 3.3:Advanced BIOS features screen.....	39
3.4.1	CPU Features	39
3.4.2	Hard Disk Boot Priority.....	40
3.4.3	Virus Warning.....	40
3.4.4	CPU L1 & L2 Cache.....	40
3.4.5	Hyper-Threading Technology.....	40
3.4.6	Quick Power On Self Test	40
3.4.7	First/Second/Third Boot Device	40
3.4.8	Boot Other Device	40
3.4.9	Swap Floppy Drive	40
3.4.10	Boot Up Floppy Seek.....	40
3.4.11	Boot Up NumLock Status.....	40
3.4.12	Gate A20 Option	40
3.4.13	Typematic Rate Setting.....	41
3.4.14	Typematic Rate (Chars/Sec).....	41
3.4.15	Typematic Delay (msec).....	41
3.4.16	Security Option	41
3.4.17	APIC Mode.....	41
3.5	Advanced Chipset Features.....	42
	Figure 3.4:Advanced chipset features screen	42
3.5.1	DRAM Timing Selectable	42
3.5.2	CAS Latency Time	43
3.5.3	DRAM RAS# to CAS# Delay	43
3.5.4	DRAM RAS# Precharge.....	43
3.5.5	Precharge Delay (t RAS)	43
3.5.6	System Memory Frequency	43
3.5.7	System BIOS Cacheable.....	43
3.5.8	Video BIOS Cacheable.....	43
3.5.9	Memory Hole At 15M-16M	44
3.5.10	PCI-Express Root Port Func.....	44
3.5.11	On-Chip Video Memory Size	44
3.5.12	On-Chip Frame Buffer Size	44
3.5.13	FIXED Memory Size.....	44
3.5.14	DVMT Memory Size.....	44
3.5.15	Init Display First.....	44
3.6	Integrated Peripherals.....	45
	Figure 3.5:Integrated peripherals	45
	Figure 3.6:On-Chip IDE Device.....	45
3.6.1	IDE HDD Block Mode	45
3.6.2	IDE DMA Transfer Access.....	45
3.6.3	On-Chip IDE Device	46
3.6.4	SATA Mode.....	46
3.6.5	On-Chip Serial ATA	46
3.6.6	PATA IDE Mode	46

3.6.7	SATA Port	46
	Figure 3.7:Onboard Device.....	47
3.6.8	USB Controller	47
3.6.9	USB 2.0 Controller	47
3.6.10	USB Keyboard/Mouse Support	47
3.6.11	AC97 Audio.....	47
3.6.12	Onboard LAN1 Control.....	47
3.6.13	Onboard LAN2 Control.....	47
	Figure 3.8:Super I/O Device.....	48
3.6.14	KBC Input Clock	48
3.6.15	Onboard FDC Controller	48
3.6.16	Onboard Serial Port 1	48
3.6.17	Onboard Serial Port 2	48
3.6.18	UART Mode Select	48
3.6.19	RxD, TxD Active.....	48
3.6.20	IR Transmission Delay	49
3.6.21	UR2 Duplex Mode.....	49
3.6.22	Use IR Pins	49
3.6.23	Onboard Parallel Port.....	49
3.6.24	Parallel Port Mode	49
3.6.25	EPP Mode Select	49
3.6.26	ECP Mode Use DMA	49
3.7	Power Management Setup.....	50
	Figure 3.9:Power management setup screen (1).....	50
3.7.1	Power Supply Type.....	50
3.7.2	ACPI Function	50
3.7.3	Power Management	51
	Table 3.1:Power Saving.....	51
3.7.4	Video Off Method.....	51
3.7.5	Video Off In Suspend	51
3.7.6	Suspend Type.....	51
3.7.7	Modem Use IRQ.....	51
3.7.8	Suspend Mode.....	51
3.7.9	Soft-Off by PWR-BTTN	52
3.7.10	CPU THRM-Throttling.....	52
3.7.11	PowerOn by Modem	52
3.7.12	PowerOn by LAN	52
3.7.13	PowerOn by Alarm	52
3.7.14	Primary IDE 0 (1) and Secondary IDE 0 (1)	52
3.7.15	FDD, COM, LPT PORT	52
3.7.16	PCI PIRQ [A-D]#	52
3.7.17	PWRON After PWR-Fail	52
3.8	PnP/PCI Configurations	53
	Figure 3.10:PnP/PCI configurations screen.....	53
3.8.1	Reset Configuration Data.....	53

3.8.2	Resources Controlled By	53
3.8.3	PCI/VGA Palette Snoop	53
3.8.4	Maximum Payload Size	53
3.9	PC Health Status.....	54
	Figure 3.11:PC Health Status Screen.....	54
3.9.1	Case Open Warning	54
3.9.2	CPU Warning Temperature	54
3.9.3	Current System Temperature	54
3.9.4	Current CPU Temperature	54
3.9.5	CPU FAN Speed.....	54
3.9.6	System FAN Speed.....	54
3.9.7	VCORE and Other Voltages.....	54
3.9.8	Shutdown Temperature.....	55
3.10	Frequency / Voltage Control	55
	Figure 3.12:Spread Spectrum Control screen	55
3.10.1	CPU Clock Ratio	55
3.10.2	Spread Spectrum	55
3.11	Password Setting	56
3.12	Save & Exit Setup	56
3.13	Exit Without Saving.....	56
Chapter 4	Chipset Software Install Utility.....	58
4.1	Before you begin	58
4.2	Introduction	58
4.3	Windows XP Driver Setup.....	59
Chapter 5	VGA Setup	64
5.1	Introduction	64
5.2	Windows XP Driver Setup.....	65
Chapter 6	Onboard Security Setup	70
6.1	Introduction	70
6.2	Windows XP Driver Setup.....	70
6.3	Using the OBS Hardware Doctor Utility	73
Chapter 7	LAN Configuration	76
7.1	Introduction	76
7.2	Features	76
7.3	Installation	76
7.4	Win XP Driver Setup (Broadcom BCM5721)	77
Appendix A	Watchdog Timer.....	82
A.1	Programming the Watchdog Timer.....	82
A.1.1	Watchdog timer overview.....	82
A.1.2	Reset/Interrupt selection	82
A.1.3	Programming the Watchdog Timer	82
	Table A.1:Watchdog timer registers.....	84

	A.1.4 Example Program	85
Appendix B	Pin Assignments	92
B.1	IDE Hard Drive Connector (CN1)	92
B.2	Floppy Drive Connector (CN3).....	93
B.3	Parallel Port (CN4).....	94
B.4	USB Header (CN6/CN63).....	95
B.5	VGA Connector (CN7)	96
B.6	RS-232 Interface (CN9/10).....	97
B.7	PS/2 Keyboard and Mouse Connector (CN11).....	98
B.8	External Keyboard Connector (CN12).....	99
B.9	Infrared (IR) connector (CN13)	99
B.10	CPU/System Fan Power Connector (CN14/15/37).....	100
B.11	Power LED and Keyboard Lock (CN16).....	100
B.12	External Speaker Connector (CN17).....	101
B.13	Reset Connector (CN18).....	101
B.14	HDD LED Connector (CN19).....	102
B.15	ATX Soft Power Switch (CN21)	102
B.16	H/W Monitor Alarm (CN22).....	102
B.17	SM Bus Connector (CN29).....	103
B.18	USB/LAN ports (CN31 and CN32)	104
B.19	Line Out, Mic IN Connector (CN55).....	104
B.20	Audio Input from CD-ROM (CD IN; CN56).....	105
B.21	Aux Line-In Connector (CN57).....	105
B.22	Front Panel Audio Connector (FP AUDIO; CN59	106
B.23	8-pin Alarm Board Connector (CN62).....	106
B.24	Case Open Connector (CN64).....	107
B.25	Front Panel LAN LED Connector (CN65)	107
B.26	System I/O Ports.....	108
B.27	DMA Channel Assignments.....	109
B.28	Interrupt Assignments	110
B.29	1st MB Memory Map.....	110

CHAPTER

1

General Information

Chapter 1 Hardware Configuration

1.1 Introduction

Advantech's AIMB-760 is designed with the Intel 915GV and ICH6 PCI Express chipset in an ATX form factor. Not only does it boast commercial PC performance but it also has industrial features such as reliability, longevity, revision control and scalability. This product is ideal for customers who are using off-the-shelf commercial motherboards but need industrial features. Designed with standardization and compatibility in mind, the AIMB-760 can be installed in a variety of Advantech industrial chassis or normal commercial chassis for various applications.

With the Intel 915GV and ICH6 chipset architecture, AIMB-760 has an 800 MHz front-side bus, supporting Intel Pentium 4 / Celeron D CPUs up to 3.8/3.06 GHz and uses up to 4 GB of dual-channel 400/533 MHz DDRII SDRAM. The integrated VGA controller dynamically shares system memory up to 128 MB, providing a low-cost but high-performance graphic function. With a south-bridge north-bridge channel Direct Media Interface (DMI) which provides a data rate up to 2 GB/s, AIMB-760 eliminates the bottleneck between the chipsets and can be equipped with high-performance network connection ports and I/O functions. The dual/single Gigabit LAN port(s) and PCI-Express x1 bus which have a data throughput of up to 500 MB/s make AIMB-760 suitable for intense industrial network applications. There are 2 PCI-Express x1 slots (one for the riser card) and 5 32-bit/33MHz PCI slots on the AIMB-760, providing good expansion capability. The 4 on-board SATA connectors not only provide a faster data transmission rate of up to 150 MB/s but also higher read/write efficiency by supporting Advanced Host Controller Interface (AHCI) technology. The thin, long SATA cable also ease cabling and thermal design inside the chassis. The 8 USB ports (4 rear I/O ports, 4 on-board headers) provide flexibility and convenience when using USB devices.

A backup of CMOS data is stored in the Flash memory, which protects BIOS setup data even after a battery failure. Also included is a 255-level watchdog timer, which resets the CPU or generates an interrupt if a program cannot be executed normally. This enables reliable operation in unattended environments.

The remote management interface enables the AIMB-760 to be managed through Ethernet when it is connected to the SNMP-1000 Remote HTTP/SNMP System Manager.

1.2 Features

- **PCI Express architecture:** Designed with the Intel 915GV and ICH6 PCI-Express chipset, the AIMB-760 has dual/single Gigabit LAN via PCI-E x1 bus and 2 PCI-E x1 slots (one for riser card).
- **High Performance I/O Capability:** Dual/single Gigabit LAN via PCI-E x1 bus, 2 PCI-E x1 slots (one for riser card), 5 PCI 32-bit/33MHz PCI slots, 4 SATA connectors and 8 USB 2.0 ports.
- **Standard ATX form factor with industrial features:** AIMB-760 provides industrial features like long product life, reliable operation under wide temperature range, watchdog timer, CMOS backup functions, etc.
- **Healthy status monitoring and remote management:** System voltage levels, fan speed, CPU temperature are monitored to ensure stable operation. The remote management interface allows the system to be managed through Ethernet when it is connected to the SNMP-1000 Remote HTTP/SNMP System Manager.
- **BIOS CMOS backup and restore:** When BIOS CMOS setup has been completed, data in the CMOS RAM is automatically backed up to the Flash ROM. This is particularly useful in harsh environments which may cause setup data loss such as battery failure. Upon such an error occurring, BIOS will check the data, and automatically restore the original data for booting.
- **Automatically power on after power failure:** It is often required to have an unattended system come back to operation when power resumes after a power failure. Advantech's industrial motherboard allows users to set the system to power on automatically without pushing the power on button.

1.3 Specifications

1.3.1 System

- **CPU:** Intel® LGA 775 Pentium 4, Celeron D up to 3.8/3.06 GHz, FSB 533/800 MHz. Advantech also certifies several high-performance CPU coolers as optional parts for customers who use high-speed CPUs in 2U chassis or in a high-temperature environment.

Note: *Advantech certified two LGA775 CPU cooler solutions for the customer, both of them are capable of keeping 115W-thermal-spec CPU temperature not over-spec under the environment temperature of 55° C without chassis or 40° C with chassis.*

1750000334: LGA 775 CPU cooler up to 3.8 GHz (115 W), 4U, 5U and 7U chassis

1750000332: LGA 775 CPU cooler up to 3.8 GHz (115 W), 2U, 4U, 5U and 7U chassis

- **L2 Cache:** CPU has built-in 1024KB/2048KB KB full-speed L2 cache (for Pentium 4 CPU) / 256/512 KB (For Celeron D CPU)
- **BIOS:** Award Flash BIOS (4Mb Flash Memory)
- **System Chipset:** Intel 915GV with ICH6
- **SATA/EIDE hard disk drive interface:** Four on-board Serial ATA connectors with data transmission rate up to 150 MB/s and supporting Advanced Host controller interface (AHCI) technology. One on-board IDE connector supporting up to two enhanced IDE devices. Supports PIO mode 4 (16.67MB/s data transfer rate) and ATA 33/66/100 (33/66/100MB/s data transfer rate.) BIOS enabled/disabled.
- **Floppy disk drive interface:** Supports one floppy disk drive, 5¼" (360 KB and 1.2 MB) or 3½" (720 KB, 1.44 MB). BIOS enable/disable

1.3.2 Memory

- **RAM:** Up to 4 GB in four 240-pin DIMM sockets. Supports dual-channel DDRII 400/533 SDRAM.

Note: *Note: Due to limitations of the PC architecture, the system can NOT fully detect 4 GB of RAM when 4 GB of RAM is installed.*

1.3.3 Input/Output

- **PCI Express x1 Bus:** 1 PCI-E slot, 500 MB/s data transmission rate
- **PCI Bus:** 5 PCI slots, 32-bit, 33 MHz PCI 2.2 compliant

- **Enhanced parallel port:** Configured to LPT1, LPT2, LPT3, or disabled. Standard DB-25 female connector provided. Supports EPP/SPP/ECP
- **Serial ports:** Two RS-232 ports with one DB-9 connector and one on-board pin header for extension. Supporting speeds up to 115.2 Kbps. Ports can be individually configured to COM1, COM2, or disabled
- **Keyboard and PS/2 mouse connector:** Two 6-pin mini-DIN connectors are located on the mounting bracket for easy connection to a PS/2 keyboard and mouse.
- **USB port:** Supports up to eight USB 2.0 ports with transmission rate up to 480Mbps.

1.3.4 Ethernet LAN

- Supporting single/dual 10/100/1000Base-T Ethernet port(s) via PCI Express x1 bus which provides 500 MB/s data transmission rate.
- **Controller:**
LAN 1: Broadcom BCM5721 (G2 version or VG version)
LAN 2: Broadcom BCM5721 (G2 Version)

Note: *The Speed & Duplex mode default setting is full duplex mode and can NOT be changed.*

1.3.5 Industrial features

- **Watchdog timer:** Can generate a system reset or IRQ11. The watchdog timer is programmable, with each unit equal to one second or one minute (255 levels)

1.3.6 Mechanical and environmental specifications

- **Operating temperature:** 0 ~ 60° C (32 ~ 140° F, Depending on CPU)
- **Storage temperature:** -20 ~ 70° C (-4 ~ 158° F)
- **Humidity:** 20 ~ 95% non-condensing
- **Power supply voltage:** +3.3V, ±5 V, ±12 V
- **Power consumption:** Maximum: +5 V at 6.64 A, +12 V at 12.59 A (Intel Pentium 4 3.4 GHz with 800 MHz FSB, 2 X 256 MB, 2 X 512 MB DDRII 533 SDRAM)
- **Board size:** 304.8 x 228.6 mm (12" x 9.6")
- **Board weight:** 0.7 kg (1.68 lb)

1.4 Jumpers and Connectors

Connectors on the AIMB-760 motherboard link it to external devices such as hard disk drives and a keyboard. In addition, the board has a number of jumpers used to configure your system for your application.

The tables below list the function of each of the board jumpers and connectors. Later sections in this chapter give instructions on setting jumpers. Chapter 2 gives instructions for connecting external devices to your motherboard.

Table 1.1: Jumpers

Label	Function
J1	CMOS Clear
J2	Watchdog timer output selection
J12	ATX, AT mode selector

Table 1.2: Connectors

Label	Function
CN1	Primary IDE connector
CN3	Floppy Drive Connector
CN4	Parallel port
CN6	USB Port 4, 5
CN7	VGA connector
CN9	Serial port: COM1
CN10	Serial port: COM2
CN11	PS/2 keyboard and mouse connector
CN12	External keyboard connector
CN13	Infrared connector
CN14	CPU FAN connector
CN15	System FAN connector 1
CN16	Power LED and Keyboard Lock
CN17	External speaker
CN18	Reset connector
CN19	HDD LED connector
CN21	ATX soft power switch (PS_ON)

Table 1.2: Connectors

Label	Function
CN22	HW Monitor Alarm Close: Enable OBS Alarm Open: Disable OBS Alarm
CN29	SM BUS Connector PIN1: SMB_DATA PIN2: SMB_CLOCK
CN31	USB port 0, 1 & LAN1
CN32	USB port 2, 3 & LAN2
CN37	System FAN connector 2
CN55	Line Out, Mic IN connector
CN56	CD IN (Audio input from CD-ROM)
CN57	AUX IN connector
CN59	Front panel audio connector
CN62	8-pin Alarm board connector
CN63	USB ports 6, 7
CN64	Case Open Connector
CN65	Front Panel LAN LED Connector
SA0	Serial ATA 0
SA1	Serial ATA 1
SA2	Serial ATA 2
SA3	Serial ATA 3
ATX1	ATX 12V Auxiliary power connector
ATX3	24-pin ATX power connector

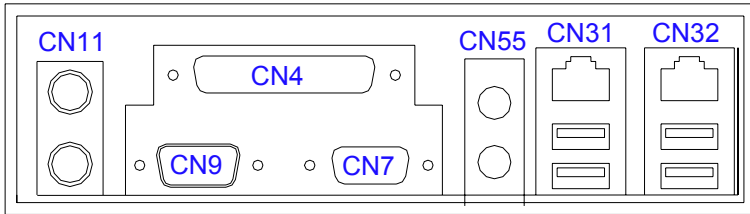

Figure 1.2: I/O Connectors

1.6 AIMB-760 Block Diagram

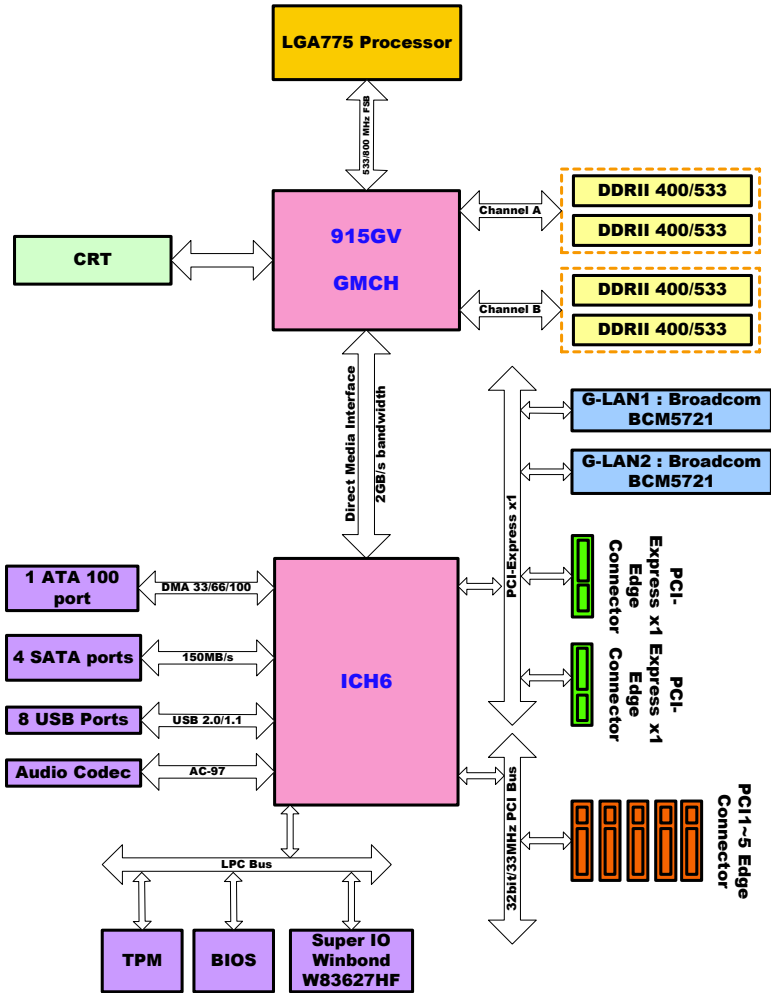

Figure 1.3: AIMB-760 Block Diagram

1.7 Safety Precautions

Warning! *Always completely disconnect the power cord from your chassis whenever you work with the hardware. Do not make connections while the power is on. Sensitive electronic components can be damaged by sudden power surges. Only experienced electronics personnel should open the PC chassis.*

Caution! *Always ground yourself to remove any static charge before touching the motherboard. Modern electronic devices are very sensitive to static electric charges. As a safety precaution, use a grounding wrist strap at all times. Place all electronic components on a static-dissipative surface or in a static-shielded bag when they are not in the chassis.*

Caution! *The computer is provided with a battery-powered Real-time Clock circuit. There is a danger of explosion if battery is incorrectly replaced. Replace only with same or equivalent type recommended by the manufacturer. Discard used batteries according to manufacturer's instructions.*

Caution! *There is a danger of a new battery exploding if it is incorrectly installed. Do not attempt to recharge, force open, or heat the battery. Replace the battery only with the same or equivalent type recommended by the manufacturer. Discard used batteries according to the manufacturer's instructions.*

1.8 Jumper Settings

This section provides instructions on how to configure your motherboard by setting the jumpers. It also includes the motherboards's default settings and your options for each jumper.



1.8.1 How to set jumpers

You can configure your motherboard to match the needs of your application by setting the jumpers. A jumper is a metal bridge that closes an electrical circuit. It consists of two metal pins and a small metal clip (often protected by a plastic cover) that slides over the pins to connect them. To “close” (or turn ON) a jumper, you connect the pins with the clip. To “open” (or turn OFF) a jumper, you remove the clip. Sometimes a jumper consists of a set of three pins, labeled 1, 2, and 3. In this case you connect either pins 1 and 2, or 2 and 3. A pair of needle-nose pliers may be useful when setting jumpers.

1.8.2 CMOS clear (J1)

The AIMB-760 motherboard contains a jumper that can erase CMOS data and reset the system BIOS information. Normally this jumper should be set with pins 1-2 closed. If you want to reset the CMOS data, set J1 to 2-3 closed for just a few seconds, and then move the jumper back to 1-2 closed. This procedure will reset the CMOS to its default setting.



Table 1.3: CMOS (J1)

Function	Jumper Setting
* Keep CMOS data	 1-2 closed
Clear CMOS data	 2-3 closed
* default setting	

1.8.3 Watchdog timer output (J2)

The AIMB-760 contains a watchdog timer that will reset the CPU or send a signal to IRQ11 in the event the CPU stops processing. This feature means the AIMB-760 will recover from a software failure or an EMI problem. The J2 jumper settings control the outcome of what the computer will do in the event the watchdog timer is tripped.



Table 1.4: Watchdog timer output (J2)

Function	Jumper Setting
IRQ11	1  1-2 closed
* Reset	1  2-3 closed

*default setting

Note: The interrupt output of the watchdog timer is a low level signal. It will be held low until the watchdog timer is reset.

Table 1.5: ATX/AT Mode selector (J12)

Function	Jumper Setting
AT Mode	1  1-2 closed
ATX Mode	1  2-3 closed

1.9 System Memory

The AIMB-760 has four sockets for 240-pin dual inline memory modules (DIMMs) in two memory channels.

All these sockets use 1.8 V unbuffered double data rate synchronous DRAMs (DDR SDRAM). They are available in capacities of 256, 512 and 1024 MB. The sockets can be filled in any combination with DIMMs of any size, giving a total memory size between 256 MB and 4 GB.

1.9.1 CPU FSB and memory speed

The AIMB-760 can accept DDR2 SDRAM memory chips without parity. Also note: The AIMB-760 accepts DDR2 400MHz SDRAM, and DDR2 533 MHz SDRAM. The AIMB-760 does NOT support ECC (error checking and correction).

1.10 Memory Installation Procedures

To install DIMMs, first make sure the two handles of the DIMM socket are in the “open” position. i.e. The handles lean outward. Slowly slide the DIMM module along the plastic guides on both ends of the socket. Then press the DIMM module right down into the socket, until you hear a click. This is when the two handles have automatically locked the memory module into the correct position of the DIMM socket. To remove the memory module, just push both handles outward, and the memory module will be ejected by the mechanism in the socket.

1.11 Cache Memory

Since the second-level (L2) cache has been embedded into the Intel® LGA-775-socket Pentium® 4 / Celeron® D processor. The built-in second-level cache in the processor yields much higher performance than the external cache memories. The cache size in the Intel® Pentium® 4 processor is 1024/2048 KB. In the Celeron D CPU, the cache size is 256 KB.

1.12 Processor Installation

The AIMB-760 is designed for Intel Pentium® 4 processor / Celeron® D (LGA 775 socket) up to 3.8/3.06 GHz.

Step 1: Pull the bar besides the CPU socket outward and lift it.

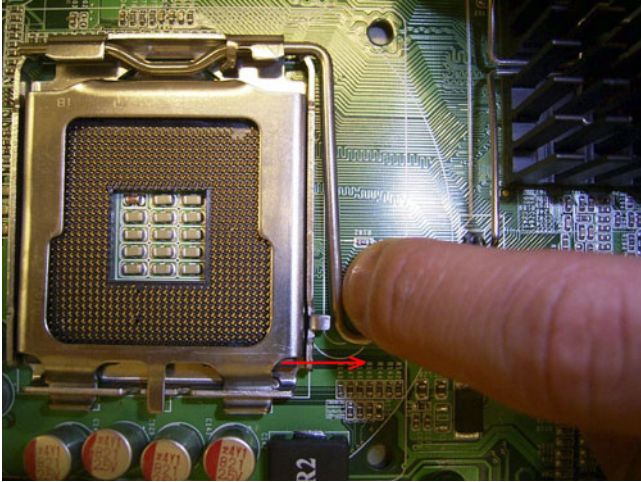

Step 2: Align the triangular marking on the processor with the cut edge of the socket.

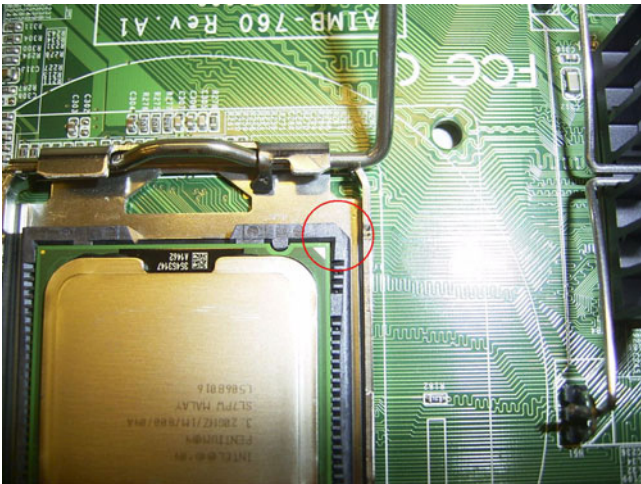

Step 3: Put back the socket cap and press down the bar to fix it.



1.13 PCI Bus Routing Table

Table 1.6: PCI Bus Routing Table

PCI Slot	ID SEL	PCI Interrupt
PCI1	AD31	INT B, C, D, A
PCI2	AD30	INT C, D, A, B
PCI3	AD29	INT D, A, B, C
PCI4	AD28	INT A, B, C, D
PCI5	AD27	INT B, C, D, A

Table 1.7: 1U PCI Riser Card PCI Bus Routing Table

PCI Slot	ID SEL	PCI Interrupt
PCI1	AD31	INT B, C, D, A

Table 1.8: 2U PCI Riser Card PCI Bus Routing Table

PCI Slot	ID SEL	PCI Interrupt
PCI1	AD31	INT B, C, D, A
PCI2	AD30	INT C, D, A, B
PCI3	AD29	INT D, A, B, C

CHAPTER
2

**Connecting
Peripherals**

Chapter 2 Connecting Peripherals

2.1 Introduction

You can access most of the connectors from the top of the board while it is installed in the chassis. If you have a number of cards installed or have a packed chassis, you may need to partially remove the card to make all the connections.

2.2 Primary (CN1) IDE Connector

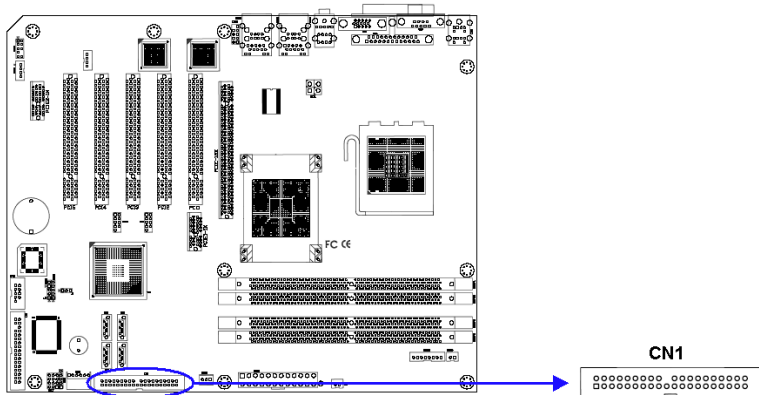

You can attach up to four IDE (Integrated Drive Electronics) drives to the AIMB-760's built-in controller. The primary (CN1) connector can each accommodate two drives.

Wire number 1 on the cable is red or blue and the other wires are gray. Connect one end to connector CN1 on the motherboard. Make sure that the red/blue wire corresponds to pin 1 on the connector (in the upper right hand corner). See Chapter 1 for help finding the connector.

Unlike floppy drives, IDE hard drives can connect in either position on the cable. If you install two drives to a single connector, you will need to set one as the master and the other as the slave. You do this by setting the jumpers on the drives. If you use just one drive on the connector, you should set the drive as the master. See the documentation that came with your drive for more information.

Connect the first hard drive to the other end of the cable. Wire 1 on the cable should also connect to pin 1 on the hard drive connector, which is

labeled on the drive circuit board. Check the documentation that came with the drive for more information.

2.3 Floppy Drive Connector (CN3)

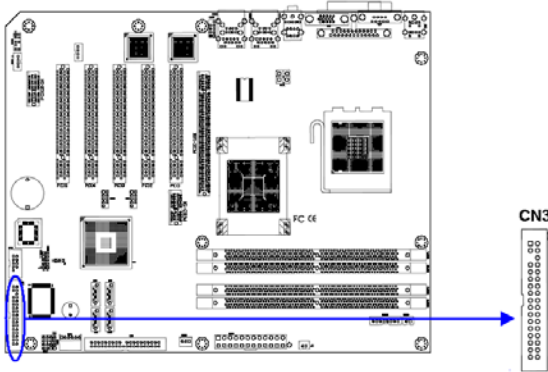

You can attach up to two floppy disk drives to the AIMB-760's onboard controller. You can use 3.5" (720 KB, 1.44 MB) drives.

The motherboard comes with a 34-pin daisy-chain drive connector cable. On one end of the cable is a 34-pin flat-cable connector. On the other end are two sets of 34-pin flat-cable connector (usually used for 3.5" drives). The set on the end (after the twist in the cable) connects to the A: floppy drive. The set in the middle connects to the B: floppy drive.

2.4 Parallel Port (CN4)

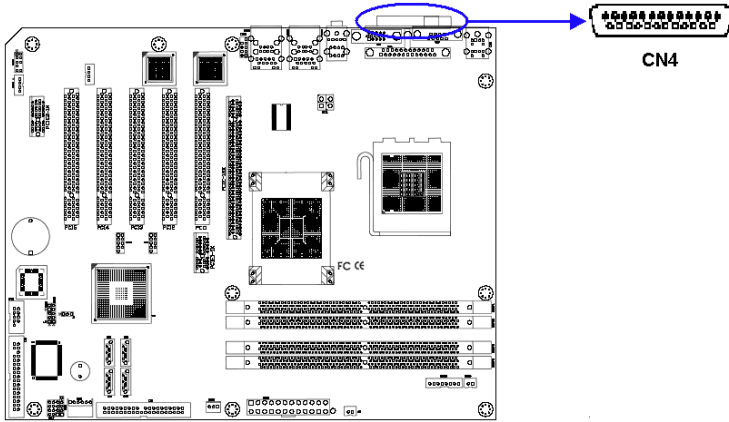

The parallel port is normally used to connect the motherboard to a printer. The AIMB-760 includes an onboard parallel port, accessed through a 26-pin flat-cable connector, CN4.

2.5 USB Ports (CN6, CN63, CN31, CN32)

The AIMB-760 provides up to eight ports of USB (Universal Serial Bus) interface which gives complete Plug & Play and hot swapping for up to 127 external devices. The USB interface complies with USB Specification Rev. 2.0 supporting transmission rate up to 480 Mbps and is fuse-protected. The USB interface can be disabled in the system BIOS setup.

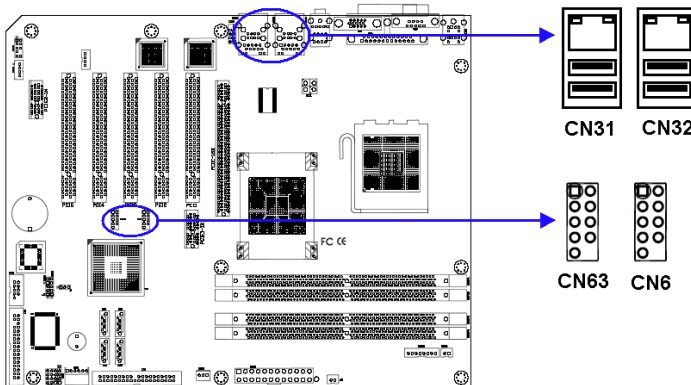
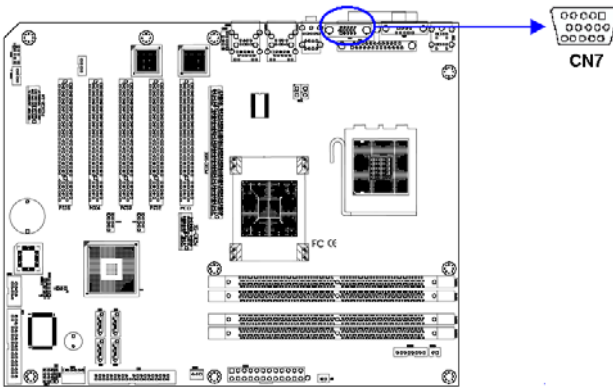

Figure 2.1: USB Ports

2.6 VGA Connector (CN7)



The AIMB-760 includes a VGA interface that can drive conventional CRT displays. CN7 is a standard 15-pin D-SUB connector commonly used for VGA. Pin assignments for CRT connector CN7 are detailed in Appendix B.

2.7 Serial Ports (COM1:CN9; COM2:CN10)

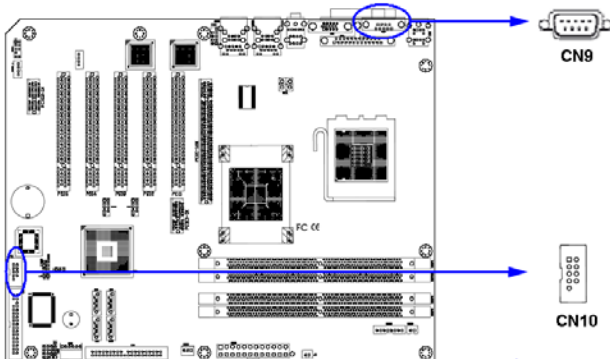

The AIMB-760 offers one serial port and one onboard connector, CN9 as COM1, CN10 as COM2. These ports can connect to serial devices, such as a mouse or a printer, or to a communications network.

The IRQ and address ranges for both ports are fixed. However, if you want to disable the port or change these parameters later, you can do this in the system BIOS setup.

Different devices implement the RS-232 standard in different ways. If you are having problems with a serial device, be sure to check the pin assignments for the connector.

2.8 PS/2 Keyboard and Mouse Connector (CN11)

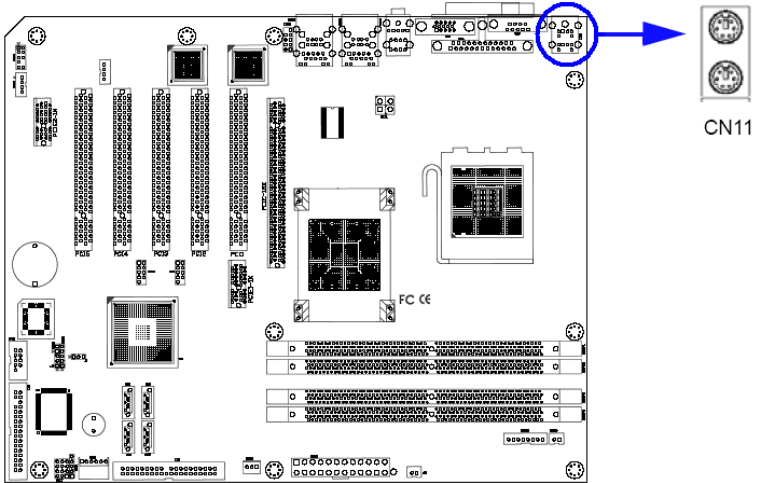

Two 6-pin mini-DIN connectors (CN11) on the motherboard provide connection to a PS/2 keyboard and a PS/2 mouse, respectively.

2.9 External Keyboard & Mouse (CN12)

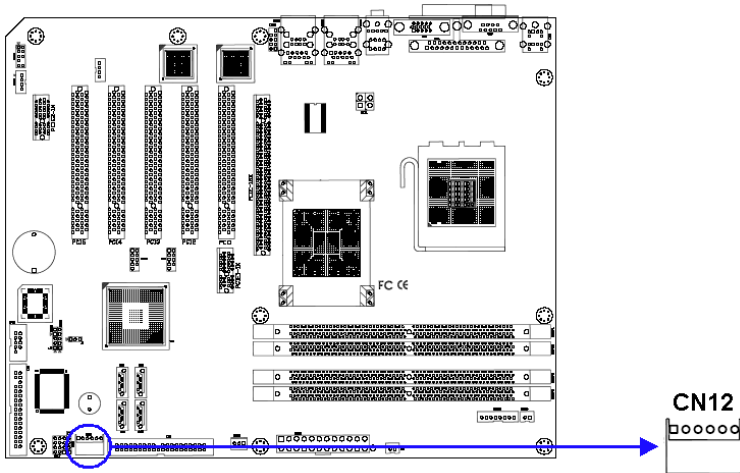

In addition to the PS/2 mouse/keyboard connector on the AIMB-760's rear plate, there is also an extra onboard external keyboard and mouse connector. This gives system integrators greater flexibility in designing their systems.

2.10 CPU Fan Connector (CN14)

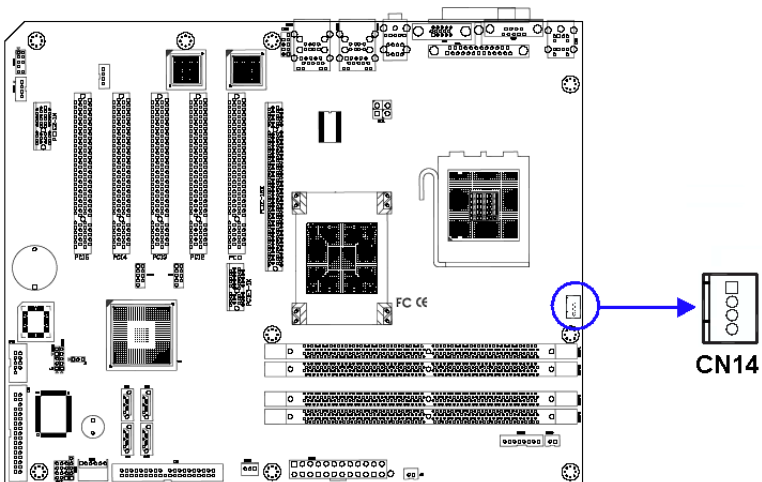

If fan is used, this connector supports cooling fans of 500 mA (6W) or less.

2.11 System FAN Connector (CN15 and CN37)

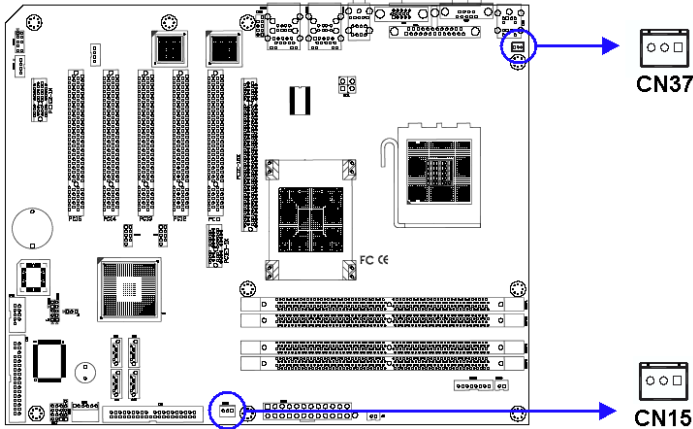

If fan is used, this connector supports cooling fans of 500 mA (6W) or less.

2.12 Front Panel Connectors (CN16, 17, 18, 19, 21&29)

There are several external switches to monitor and control the AIMB-760.

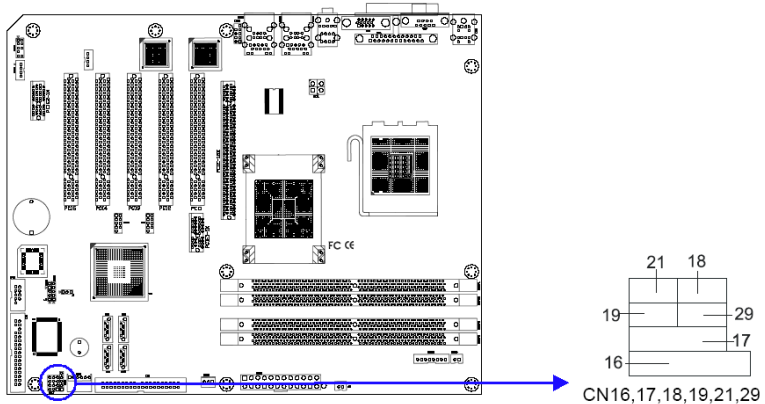

2.12.1 Power LED and Keyboard Lock (CN16)

CN16 is a 5-pin connector for the power LED. Refer to Appendix B for detailed information on the pin assignments. If a PS/2 or ATX power supply is used, the system's power LED status will be as indicated below:

Table 2.1: PS/2 or ATX power supply LED status

Power mode	LED (PS/2 power)	LED (ATX power)
System On	On	On
System Suspend	Fast flashes	Fast flashes
System Off	Off	Slow flashes

2.12.2 External Speaker (CN17)

CN17 is a 4-pin connector for an external speaker. If there is no external speaker, the AIMB-760 provides an onboard buzzer as an alternative. To enable the buzzer, set pins 3-4 as closed.

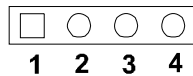

2.12.3 Reset Connector (CN18)

Many computer cases offer the convenience of a reset button. Connect the wire from the reset button



2.12.4 HDD LED Connector (CN19)

You can connect an LED to connector CN19 to indicate when the HDD is active.



2.12.5 ATX Soft Power Switch (CN21)

If your computer case is equipped with an ATX power supply, you should connect the power on/off button on your computer case to CN21. This connection enables you to turn your computer on and off.

2.12.6 SM Bus Connector (CN29)

This connector is reserved for Advantech's SNMP-1000 HTTP/SNMP Remote System Manager. The SNMP-1000 allows users to monitor the internal voltages, temperature and fans from a remote computer through an Ethernet network.

CN29 can be connected to CN19 of SNMP-1000. Please be careful about the pin assignments, pin 1 must be connected to pin 1 and pin 2 to pin 2 on both ends of cable.

2.13 H/W Monitor Alarm (CN22)

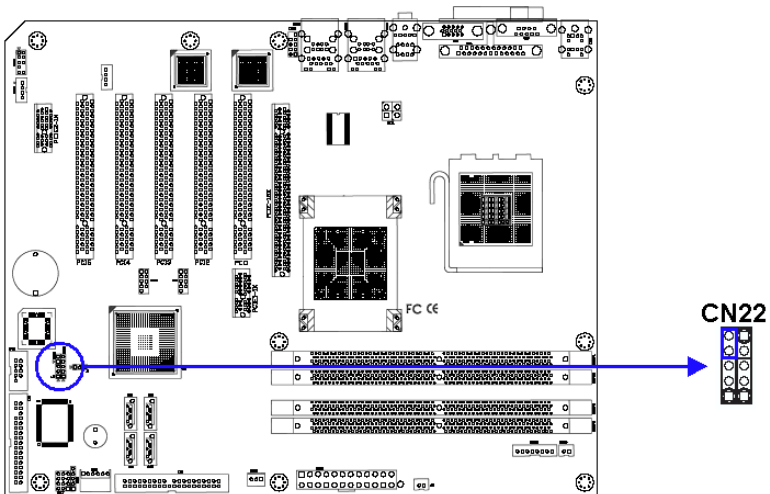

Close: Enable OBS Alarm

Open: Disable OBS Alarm

2.14 USB and LAN ports (CN31 and CN32)

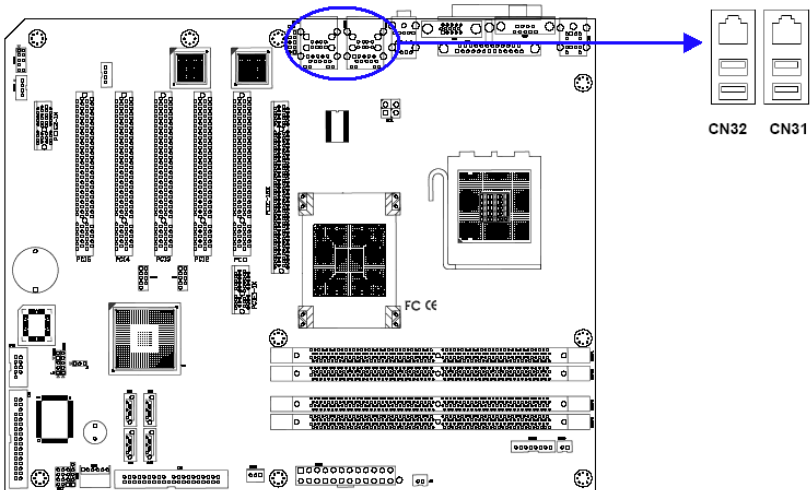

The AIMB-760 provides up to eight USB (Universal Serial Bus) ports, which gives complete Plug & Play and hot swapping for up to 127 external devices. The USB interface complies with USB Specification Rev. 2.0 support transmission rate up to 480 Mbps and is fuse-protected. The USB interface can be disabled in the system BIOS setup.

The AIMB-760 is equipped with one or two high-performance 1000 Mbps Ethernet LANs. They are supported by all major network operating systems. The RJ-45 jacks on the rear plate provide convenient or 1000 Base-T operation.

2.15 Line Out, Mic In Connector (CN55)

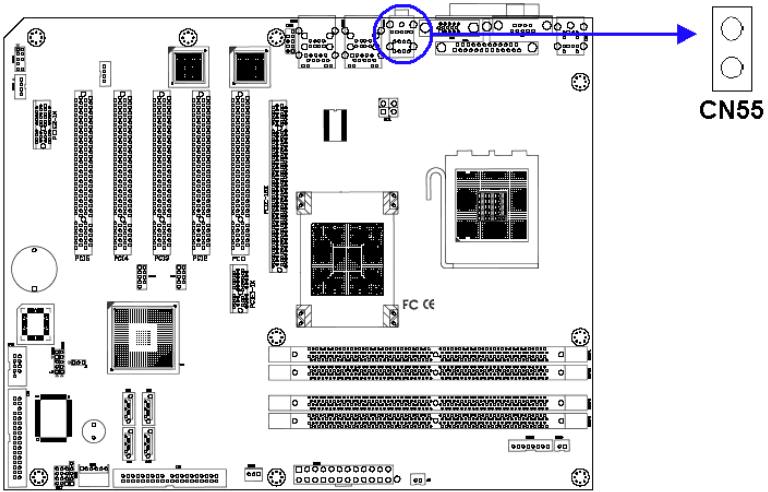

The Line Out is to output the audio signal to external audio device, like speakers or headphones. The Mic In is for the audio signal input via microphones.

2.16 Audio Input from CD-ROM (CD IN; CN56)

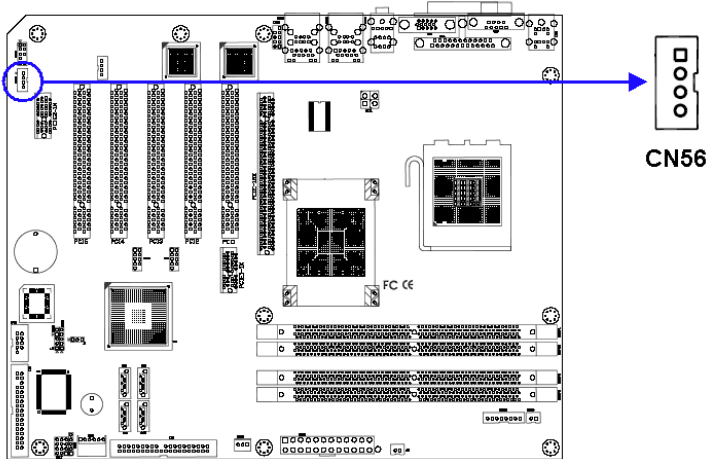

CD IN is connected the CD-ROM audio output.

2.17 Aux Line-In Connector (AUX IN; CN57)

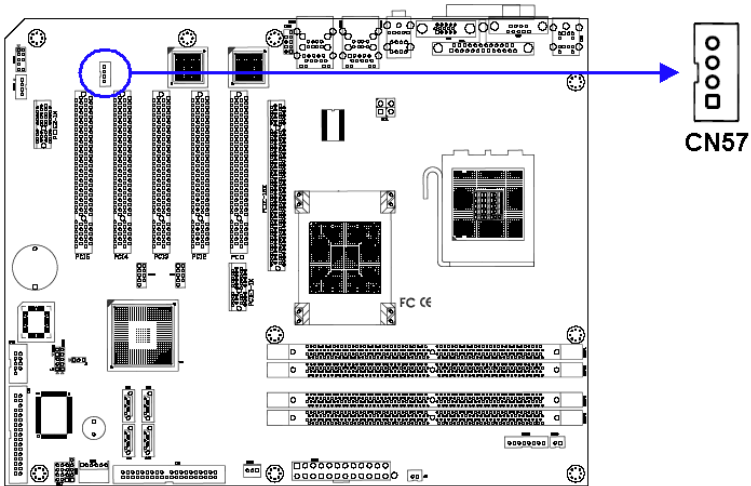

The connector is for audio devices with a Line-in connector.

2.18 Front Panel Audio Connector (FP AUDIO; CN59)

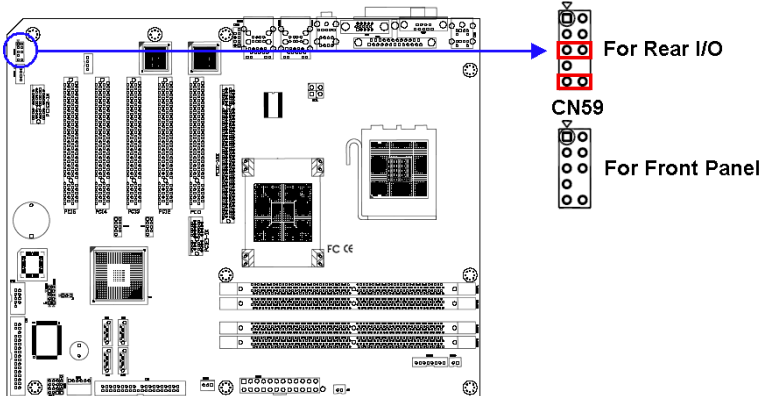

The FPAUDIO is a front panel audio connector compliant with Intel® Front Panel I/O Connectivity Design Guide. To direct the audio signal output to the rear audio ports, the 5 and 6 pins, 9 and 10 pins must be shorted by jumper to activate the rear panel audio function.

2.19 8-pin Alarm Board Connector (CN62)

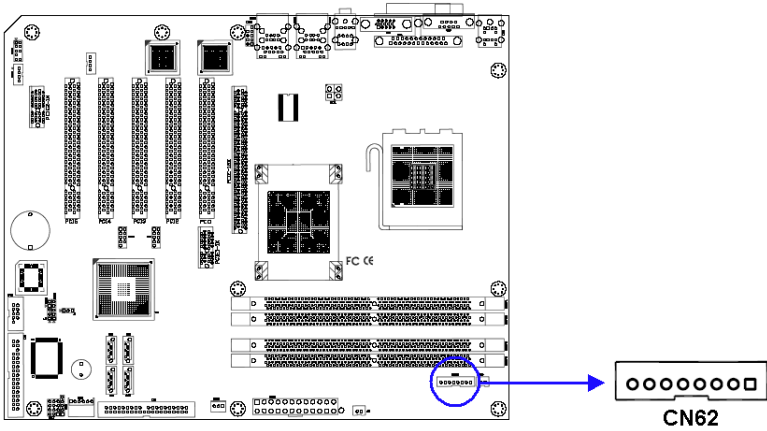

The 8-pin alarm board connector is for Advantech chassis with alarm board, which gives warnings if the power supply or fan fails; if the chassis overheats; or if the backplane malfunctions.

2.20 Case Open Connector (CN64)

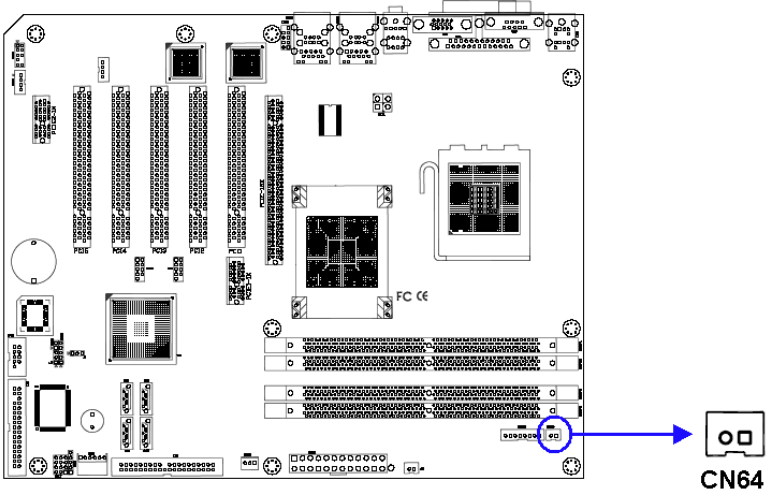

The 2-pin case open connector is for chassis with a case open sensor. While opening the case, the buzzer on motherboard will ring.

2.21 Front Panel LAN Indicator Connector

Table 2.2: Front Panel LAN Indicator Connector

LAN Mode	Indicator
G-LAN Link ON	Green ON
G-LAN Active	Green Flash
G-LAN Link Off	Green OFF

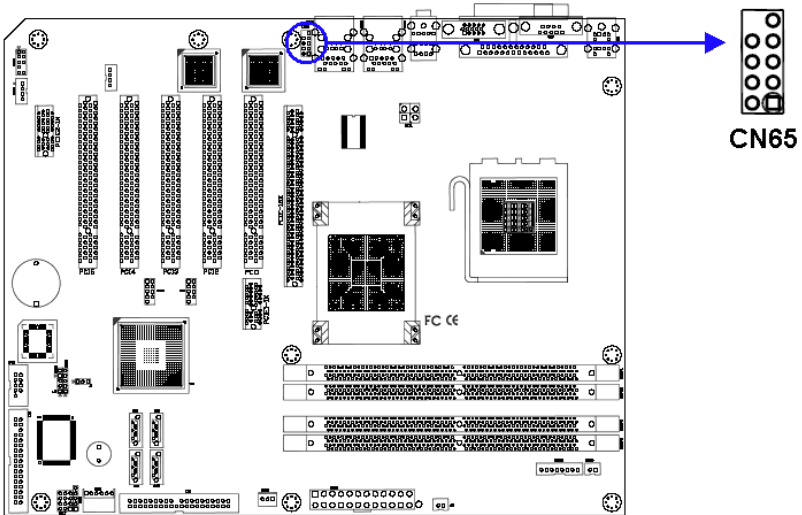

2.22 Serial ATA Interface (SA0, SA1, SA2, SA3)

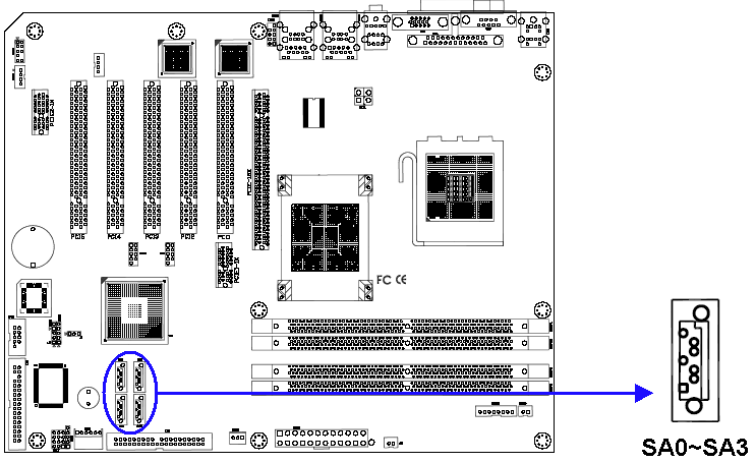

In addition to the EIDE interface (up to two devices), the AIMB-760 features a high performance serial ATA interface (up to 150 MB/s) which eases cabling to hard drives with thin and long cables.

2.23 PCI Slots (PCI 1 ~ PCI 5)

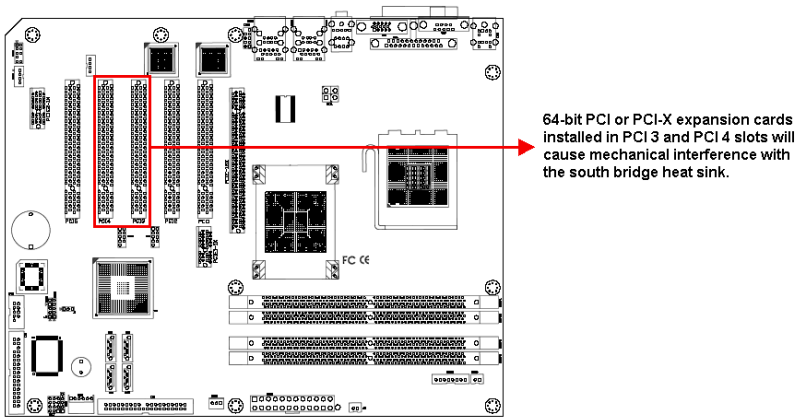

The AIMB-760 provides 5 32-bit / 33 MHz PCI slots.

Note: *64-bit PCI or PCI-X expansion cards installed in the PCI 3 and PCI 4 slots will not fit because of the south bridge heat sink. If you want to use 64-bit PCI or PCI-X expansion cards, please install them in the PCI 2 or PCI 5 slot.*

2.24 Connecting to SNMP-1000 Remote Manager

Use the 6-pin to 8-pin cable to connect the motherboard to SNMP-1000. This cable comes with the SNMP-1000.

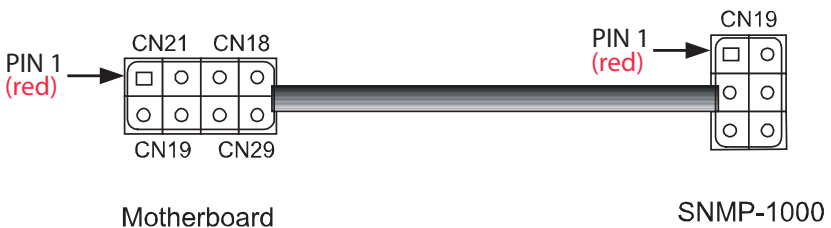

2.25 Auxiliary 4-pin power connector (ATX1)

To ensure the enough power is supplied to the motherboard, one auxiliary 4 pin power connector is available on the AIMB-760. ATX1 must be used to provide sufficient 12 V power to ensure the stable operation of the system.

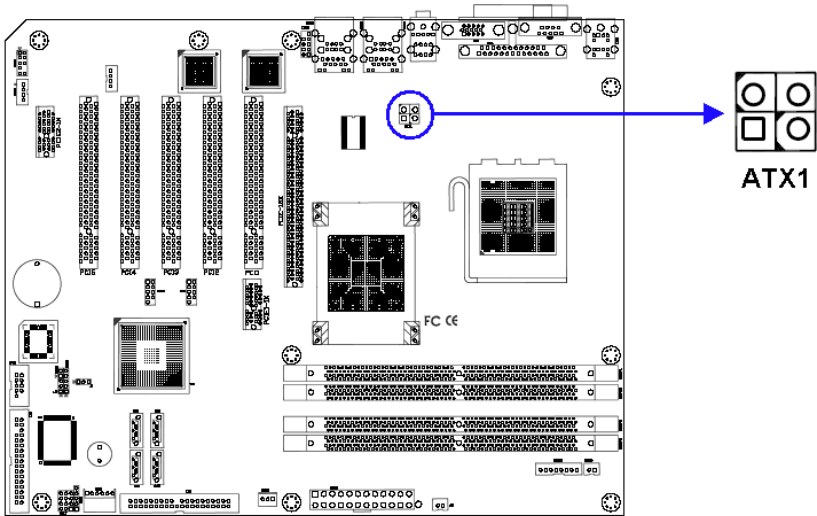

CHAPTER
3

Award BIOS Setup

Chapter 3 Award BIOS Setup

3.1 Introduction

Award's BIOS ROM has a built-in setup program that allows users to modify the basic system configuration. This type of information is stored in battery backed-up memory (CMOS RAM) so that it retains the setup information when the power is turned off.

3.1.1 CMOS RAM Auto-backup and Restore

The CMOS RAM is powered by an onboard button cell battery. When you finish BIOS setup, the data in CMOS RAM will be automatically backed up to Flash ROM. If operation in harsh industrial environments causes a soft error, BIOS will recheck the data in CMOS RAM and automatically restore the original data in Flash ROM to CMOS RAM for booting.

Note: If you intend to change the CMOS setting without restoring the previous backup, you have to click on "DEL" within two seconds of the "CMOS checksum error..." display screen message appearing. Then enter the "Setup" screen to modify the data. If the "CMOS checksum error..." message appears again and again, please check to see if you need to replace the battery in your system.

3.2 Entering Setup

Turn on the computer and press to enter the BIOS setup.

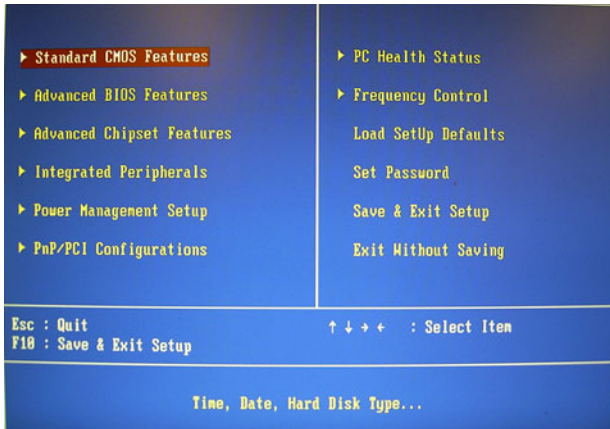

Figure 3.1: Award BIOS Setup initial screen

3.3 Standard CMOS Setup

3.3.1 Date

The date format is <week>, <month>, <day>, <year>.

3.3.2 Time

The time format is <hour> <minute> <second>, based on the 24-hour clock.

3.3.3 IDE channel 0/1 Master/Slave

- **IDE HDD Auto-Detection:** Press “Enter” to select this option for automatic device detection.
- **IDE Device Setup:**
 - Auto:** Automatically detects IDE devices during POST
 - None:** Select this when no IDE device is used. The system will skip the auto-detection step to make system start up faster.
 - Manual:** User can manually input the correct settings.
- **Access Mode:** The options are CHS/LBA/Large/Auto
- **Capacity:** Capacity of currently installed hard disk.
- **Cylinder:** Number of cylinders
- **Head:** Number of heads
- **Precomp:** Write precomp

- **Landing Zone:** Landing zone
- **Sector:** Number of sectors

3.3.4 Drive A / Drive B

This category identifies the types of floppy disk drives installed in the system. The options are: None/360K, 5.25"/1.2M, 5.25"/720K, 3.5"/1.44M, 3.5"/2.88M, 3.5".

3.3.5 Halt On

This category determines whether system start-up will halt or not when an error is detected during power up.

The options are: No Errors/All Errors/All, But Keyboard/All, But Diskette/All, But Disk/Key

3.3.6 Memory

This category displays base memory, extended memory, and total memory detected during POST (Power On Self Test).

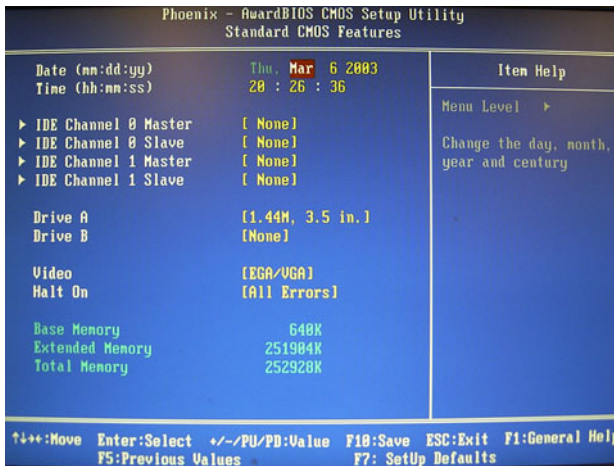

Figure 3.2: Standard CMOS Features Screen

3.4 Advanced BIOS Features

The “Advanced BIOS Features” screen appears when choosing the “Advanced BIOS Features” item from the “Initial Setup Screen” menu. It allows the user to configure the AIMB-760 according to his particular requirements. Below are some major items that are provided in the Advanced BIOS Features screen. A quick booting function is provided for your convenience. Simply enable the Quick Booting item to save yourself valuable time.

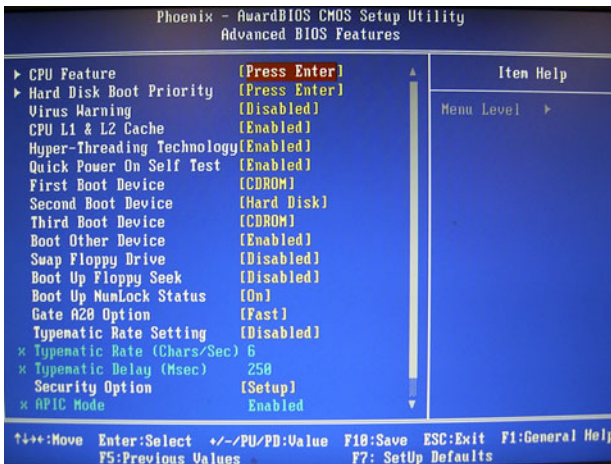

Figure 3.3: Advanced BIOS features screen

3.4.1 CPU Features

Delay Prior to thermal

This feature controls the activation of the Thermal Monitor's automatic mode. It allows you to determine when the Pentium 4's Thermal Monitor should be activated in automatic mode after the system boots. For example, with the default value of 16 Minutes, the BIOS activates the Thermal Monitor in automatic mode 16 minutes after the system starts booting up. The choices are 4 Min, 8 Min, 16 Min, and 32 Min.

Limit CPUID MaxVal

Set Limit CPUID MaxVal to 3. This should be disabled for WinXP.

Execute Disable Bit

When disabled, forces the XD feature flag to always return 0.

3.4.2 Hard Disk Boot Priority

Set hard disk boot device priority.

3.4.3 Virus Warning

Enables or disables the virus warning.

3.4.4 CPU L1 & L2 Cache

Enabling this feature speeds up memory access. The commands are “Enabled” or “Disabled.”

3.4.5 Hyper-Threading Technology

While using a CPU with Hyper-Threading technology, you can select “Enabled” to enable Hyper-Threading Technology in an OS which supports Hyper-Threading Technology or select “Disabled” for other OSs which do not support Hyper-Threading technology.

3.4.6 Quick Power On Self Test

This allows the system to skip certain tests to speed up the boot-up procedure.

3.4.7 First/Second/Third Boot Device

The BIOS tries to load the OS from the devices in the sequence set here. The options are: “Floppy”, “LS120”, “HDD-0”, “SCSI”, “CDROM”, “HDD-1”, “HDD-2”, “HDD-3”, “ZIP100”, “USB-FDD”, “USB-ZIP”, “USBCDROM”, “USB-HDD”, “LAN”, and “Disabled”.

3.4.8 Boot Other Device

Use this to boot another device. The options are “Enabled” and “Disabled”.

3.4.9 Swap Floppy Drive

If the system has two floppy drives, choose “Enabled” to assign physical drive B to logical drive A and vice-versa. The commands are “Enabled” or “Disabled”.

3.4.10 Boot Up Floppy Seek

Selection of the command “Disabled” will speed the boot up. Selection of “Enabled” searches disk drives during boot up.

3.4.11 Boot Up NumLock Status

Sets the boot up status Num Lock. The options are “On” and “Off”.

3.4.12 Gate A20 Option

“Normal”: A pin in the keyboard controller controls GateA20. Fast (Default) lets chipset control GateA20.

3.4.13 Typematic Rate Setting

The typematic rate is the rate key strokes repeat as determined by the keyboard controller. The commands are “Enabled” or “Disabled”. Enabling allows the typematic rate and delay to be selected.

3.4.14 Typematic Rate (Chars/Sec)

The BIOS accepts the following input values (characters/second) for typematic rate: 6, 8, 10, 12, 15, 20, 24, and 30.

3.4.15 Typematic Delay (msec)

Typematic delay is the time interval between the appearances of two consecutive characters, when the key is continuously depressed. The input values for this category are: 250, 500, 750, and 1000 (ms).

3.4.16 Security Option

This category determines whether the password is required when the system boots up or only when entering setup. The options are:

- **System:** The system will not boot, and access to Setup will be also denied unless the correct password is entered at the prompt.
- **Setup:** The system will boot, but access to Setup will be denied unless the correct password is entered at the prompt.

Note: To disable security, select PASSWORD SETTING in the main menu. Then, you will be asked to enter a password. Simply press <Enter> to disable security. When security is disabled, the system will boot and you can enter Setup freely.

3.4.17 APIC Mode

This setting allows you to enable the APIC mode. The choices are “Disabled” or “Enabled.”

3.5 Advanced Chipset Features

By choosing the “Advanced Chipset Features” option from the “Initial Setup Screen” menu, the screen below will be displayed. This sample screen contains the manufacturer’s default values for the AIMB-760, as shown in Figure 3-4:

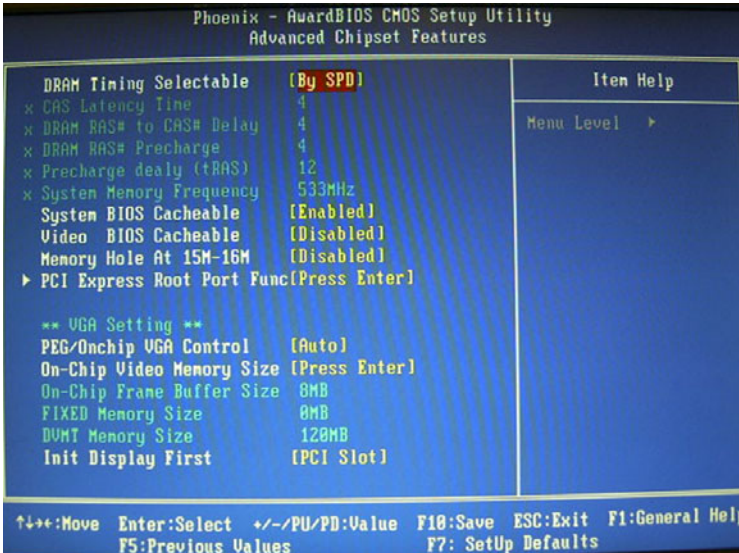

Figure 3.4: Advanced chipset features screen

Note: DRAM default timings have been carefully chosen and should ONLY be changed if data is being lost. Please first contact technical support.

3.5.1 DRAM Timing Selectable

This item allows you to control the DRAM speed. The selections are “Manual” or “By SPD”.

3.5.2 CAS Latency Time

When DRAM Timing Selectable is set to [Manual], this field is adjustable. This controls the CAS latency, which determines the time interval between SDRAM starting a read command and receiving it. The options are [3T], [4T], [5T], and [Auto].

3.5.3 DRAM RAS# to CAS# Delay

When DRAM Timing selectable is set to [Manual], this field is adjustable. When DRAM is refreshed, the rows and columns are addressed separately. This setup item allows user to determine the timing of the transition from RAS (row address strobe) to CAS (column address strobe). The less the clock cycles are, the faster the DRAM speed is. Setting options are [2T] to [5T], and [Auto].

3.5.4 DRAM RAS# Precharge

When the DRAM Timing Selectable is set to [Manual], this field is adjustable. This setting controls the number of cycles for Row Address Strobe (RAS) to be allowed to precharge. If no sufficient time is allowed for the RAS to accumulate its charge before DRAM refresh, refreshing may be incomplete and DRAM may fail to retain data. This item applies only when synchronous DRAM is installed in the system. Setting options are [2T] to [5T], and [Auto].

3.5.5 Precharge Delay (t RAS)

This item allows you to select the value in this field, depending on whether the board has paged DRAMs or EDO (extended data output) DRAMs. The choices are: “4” to “15” and “Auto”.

3.5.6 System Memory Frequency

To adjust the frequency of memory. The choices are: “333MHz”, “400MHz”, “533MHz” and “Auto”.

3.5.7 System BIOS Cacheable

Selecting “Enabled” allows caching of the system BIOS ROM at F0000h-FFFFFh, resulting in better system performance. However, if any program writes data to this memory area, a system error may occur. The Choices are “Enabled”, and “Disabled”.

3.5.8 Video BIOS Cacheable

Selecting “Enabled” allows caching of the video BIOS, resulting in better system performance. However, if any program writes to this memory area, a system error may occur. The choices are “Enabled”, and “Disabled”.

3.5.9 Memory Hole At 15M-16M

Enabling this feature reserves 15 MB to 16 MB memory address space for ISA expansion cards that specifically require this setting. This makes memory from 15 MB and up unavailable to the system. Expansion cards can only access memory up to 16 MB. The default setting is “Disabled”.

3.5.10 PCI-Express Root Port Func

PCI Express Port 1/2/3/4

The default setting is “Auto.” The choices are “Enabled,” “Disabled,” and “Auto.”

PCI-E Compliancy Mode

This allows the user to select the PCI-E compliant mode. The options are [v1.0], and [v1.0a].

3.5.11 On-Chip Video Memory Size

Use this field to select the On-Chip Frame Buffer Size, Fixed Memory Size and DVMT Memory Size. The total graphics memory can be up to 128 MB.

3.5.12 On-Chip Frame Buffer Size

The On-Chip Frame Buffer Size can be set to 1 MB or 8 MB. This memory is shared with the system memory.

3.5.13 FIXED Memory Size

Specify the size of system memory to allocate for video memory.

3.5.14 DVMT Memory Size

Specify the size of DVMT memory to allocate for video memory.

3.5.15 Init Display First

Choose the first display interface to initiate while booting. The choice is “PCI Slot” or “Onboard”.

3.6 Integrated Peripherals

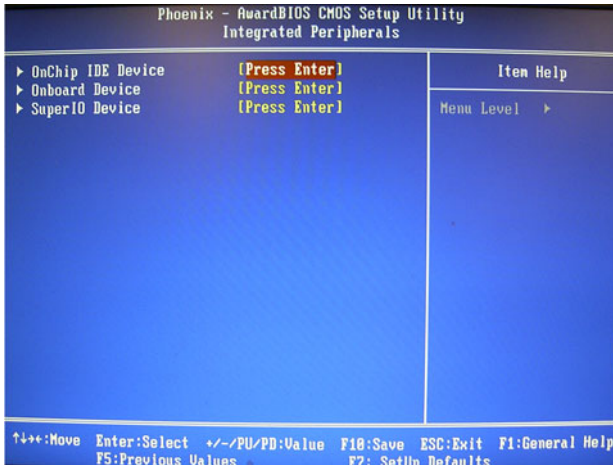

Figure 3.5: Integrated peripherals

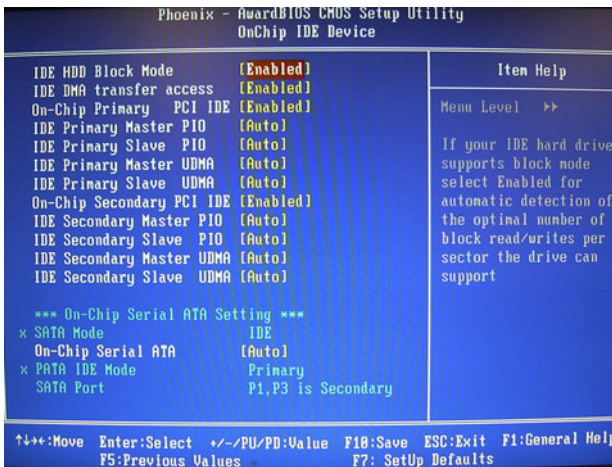

Figure 3.6: On-Chip IDE Device

3.6.1 IDE HDD Block Mode

If your IDE hard drive supports block mode select Enabled for automatic detection of the optimal number of block read/writes per sector the drive can support.

3.6.2 IDE DMA Transfer Access

Use this field to enable or disable IDE DMA transfer access.

3.6.3 On-Chip IDE Device

IDE Primary Master/Slave PIO/UDMA Mode (Auto). The channel has both a master and a slave, making four IDE devices possible. Because two IDE devices may have a different Mode timing (0, 1, 2, 3, 4), it is necessary for these to be independent. The default setting “Auto” will allow auto detection to ensure optimal performance.

3.6.4 SATA Mode

The setting choices for the SATA Mode are IDE, RAID and AHCI Mode. Select [IDE] if you want to have SATA function as IDE. Select [AHCI] for Advanced Host Controller Interface (AHCI) feature, with improved SATA performance and native command queuing. Select [RAID] to use SATA for RAID. RAID is only supported on the board if it uses ICH6R.

3.6.5 On-Chip Serial ATA

Choose the status of serial ATA. The default setting is “Auto” which lets the system arrange all parallel and serial ATA resources automatically. The “Disabled” setting disables the SATA controller. The “Combined Mode” combines PATA and SATA, and maximum of 2 IDE drives in each channel. The “Enhanced Mode” enables both SATA and PATA, and a maximum of 6 IDE drives are supported. The “SATA Only” setting means SATA is operating in legacy mode.

3.6.6 PATA IDE Mode

This item allows you to select the parallel ATA channel. Setting options are Primary and Secondary.

3.6.7 SATA Port

This feature allows users to view the SATA port as primary or secondary channel. If PATA IDE Mode is set to “Primary”, it will display “P1, P3 Secondary” which means that SATA1 and SATA3 are secondary. If PATA IDE Mode is set to “Secondary,” it will display “P0, P2 Secondary” which means that SATA0 and SATA2 are secondary.

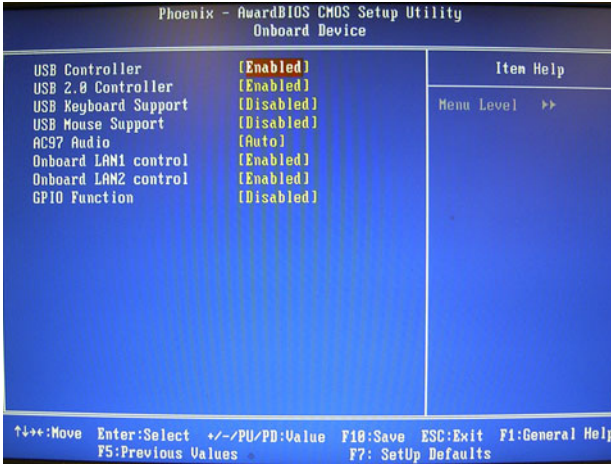

Figure 3.7: Onboard Device

3.6.8 USB Controller

Select Enabled if your system contains a Universal Serial Bus (USB) controller and you have USB peripherals. The choices are “Enabled” and “Disabled”.

3.6.9 USB 2.0 Controller

This entry is to disable/enable the USB 2.0 controller only. The BIOS itself may/may not have high-speed USB support. If the BIOS has high speed USB support built in, the support will automatically turn on when a high speed device is attached. The choices are “Enabled” or “Disabled”.

3.6.10 USB Keyboard/Mouse Support

Select Enabled if you plan to use an USB keyboard. The choices are “Enabled” and “Disabled”.

3.6.11 AC97 Audio

Select “Disable” if you do not want to use AC-97 audio. Options are “Auto”, and “Disabled”.

3.6.12 Onboard LAN1 Control

Options are “Enabled” and “Disabled”. Select “Disabled” if you don’t want to use onboard LAN controller1.

3.6.13 Onboard LAN2 Control

Options are “Enabled” and “Disabled”. Select Disabled if you don’t want to use the onboard LAN controller2.

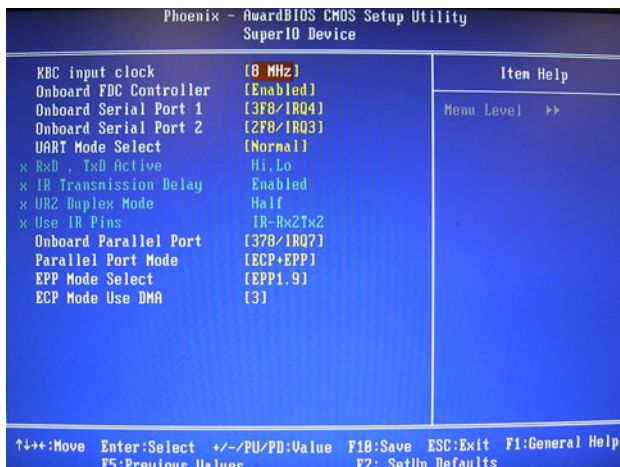

Figure 3.8: Super I/O Device

3.6.14 KBC Input Clock

This BIOS feature allows you to adjust the keyboard interface clock for a better response or to fix a keyboard problem. It is recommended that you select the 16 MHz option for a better keyboard response. But if the keyboard performs erratically or fails to initialize, try a lower clock speed.

3.6.15 Onboard FDC Controller

When enabled, this field allows you to connect your floppy disk drives to the onboard floppy disk drive connector instead of a separate controller card. If you want to use a different controller card to connect the floppy disk drives, set this field to Disabled.

3.6.16 Onboard Serial Port 1

The settings are “3F8/IRQ4”, “2F8/IRQ3”, “3E8/IRQ4”, “2E8/IRQ3”, and “Disabled” for the on-board serial connector.

3.6.17 Onboard Serial Port 2

The settings are “3F8/IRQ4”, “2F8/IRQ3”, “3E8/IRQ4”, “2E8/IRQ3”, and “Disabled” for the on-board serial connector.

3.6.18 UART Mode Select

This item allows you to select UART mode. The choices: “IrDA”, “ASKIR”, and “Normal”.

3.6.19 RxD, TxD Active

This item allows you to determine the active level of the RxD and TxD serial lines. The Choices: “Hi, Hi”, “Lo, Lo”, “Lo, Hi”, and “Hi, Lo”.

3.6.20 IR Transmission Delay

This item allows you to enable/disable IR transmission delay. The choices are “Enabled” and “Disabled”.

3.6.21 UR2 Duplex Mode

This item allows you to select the IR half/full duplex function. The choices are “Half” and “Full”.

3.6.22 Use IR Pins

The choices are “RxD2, TxD2” and “IR-Rx2Tx2”.

3.6.23 Onboard Parallel Port

This field sets the address of the on-board parallel port connector. You can select “378/IRQ7”, “278/IRQ5”, “3BC/IRQ7”, or “Disabled”. If you install an I/O card with a parallel port, make sure there is no conflict in the address assignments. The single board computer can support up to three parallel ports.

3.6.24 Parallel Port Mode

This field allows you to set the operation mode of the parallel port. The setting “Normal” allows normal speed operation, but in one direction only. “EPP” allows bidirectional parallel port operation at maximum speed. “ECP” allows the parallel port to operate in bidirectional mode and at a speed faster than the maximum data transfer rate. “ECP + EPP” allows normal speed operation in a two-way mode.

3.6.25 EPP Mode Select

This field allows you to select EPP port type 1.7 or 1.9. The choices are “EPP1.9” and “EPP1.7”.

3.6.26 ECP Mode Use DMA

This selection is available only if you select “ECP” or “ECP + EPP” in the Parallel Port Mode field. In ECP Mode, you can select DMA channel 1 or DMA channel 3. Leave this field on the default setting.

3.7 Power Management Setup

The power management setup controls the single board computer's “green” features to save power. The following screen shows the manufacturer’s defaults.

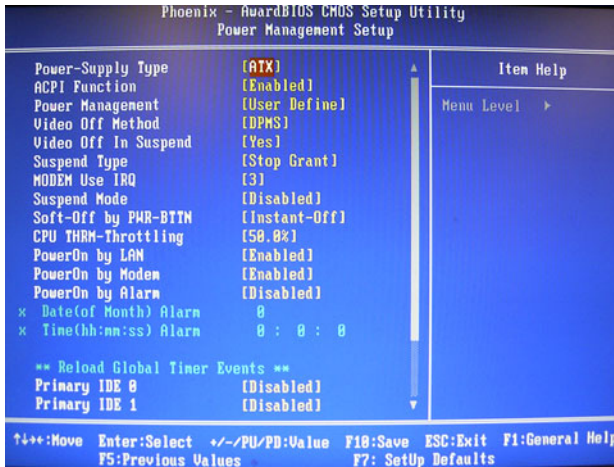

Figure 3.9: Power management setup screen (1)

3.7.1 Power Supply Type

AIMB-760 can support both “ATX” and “AT” power supplies. Customers can choose the PSU type through this selection. The choices are “ATX” and “AT”. Selecting “AT” disables the ACPI function automatically.

3.7.2 ACPI Function

The choices are: “Enabled” and “Disabled”.

3.7.3 Power Management

This category allows you to select the type (or degree) of power saving and is directly related to the following modes:

- HDD Power Down
- Suspend Mode

There are three selections for Power Management, and they have fixed mode settings.

Table 3.1: Power Saving

Saving Mode	Function
Min Saving	Minimum power management., Suspend Mode = 1 hr., and HDD Power Down = 15 min.
Max Saving	Maximum power management., Suspend Mode = 1 min., and HDD Power Down = 1 min.
User Defined (Default)	Allows you to set each mode individually. When not disabled, each of the ranges are from 1 min. to 1 hr. except for HDD Power Down which ranges from 1 min. to 15 min., and disabled.

3.7.4 Video Off Method

Use this to select the method to turn off the video. The choices are “Blank Screen”, “V/H SYNC+ Blank”, and “DPMS”.

3.7.5 Video Off In Suspend

When the system is in suspend mode, the video will turn off. The choices are “No” and “Yes”.

3.7.6 Suspend Type

The choices are “Stop Grant” and “PwrOn Suspend”.

3.7.7 Modem Use IRQ

This determines the IRQ that the MODEM can use. The choices are “3”, “4”, “5”, “7”, “9”, “10”, “11”, and “NA”.

3.7.8 Suspend Mode

Please refer to 3.7.3

3.7.9 Soft-Off by PWR-BTTN

If you choose “Instant-Off”, then pushing the ATX soft power switch button once will switch the system to “system off” power mode. You can choose “Delay 4 sec”. If you do, then pushing the button for more than 4 seconds will turn off the system, whereas pushing the button momentarily (for less than 4 seconds) will switch the system to “suspend” mode.

3.7.10 CPU THRM-Throttling

This field allows you to select the CPU THRM-Throttling rate. The choices: “75.0%”, “50.0%”, and “25.0%”.

3.7.11 PowerOn by Modem

To enabled or disable the function to power on the system via a Modem connection from a remote host. The choice “Enabled” and “Disabled”.

3.7.12 PowerOn by LAN

This item allows you to power on the system by LAN. The choices are “Enabled” and “Disabled”.

3.7.13 PowerOn by Alarm

The choices are “Enabled” and “Disabled”.

3.7.14 Primary IDE 0 (1) and Secondary IDE 0 (1)

When Enabled, the system will resume from suspend mode if Primary IDE 0 (1) or Secondary IDE 0 (1) becomes active. The choices are “Enabled” and “Disabled”.

3.7.15 FDD, COM, LPT PORT

When Enabled, the system will resume from suspend mode if the FDD, interface, COM port, or LPT port is active. The choices are “Enabled” and “Disabled”.

3.7.16 PCI PIRQ [A-D]#

When Enabled, the system resumes from suspend mode if an interrupt occurs. The choices are “Enabled” and “Disabled”.

3.7.17 PWRON After PWR-Fail

Use this to set up the system after power failure. The “Off” setting keeps the system powered off after power failure, the “On” setting boots up the system after failure, and the “Former-Sts” returns the system to the status before power failure.

3.8 PnP/PCI Configurations

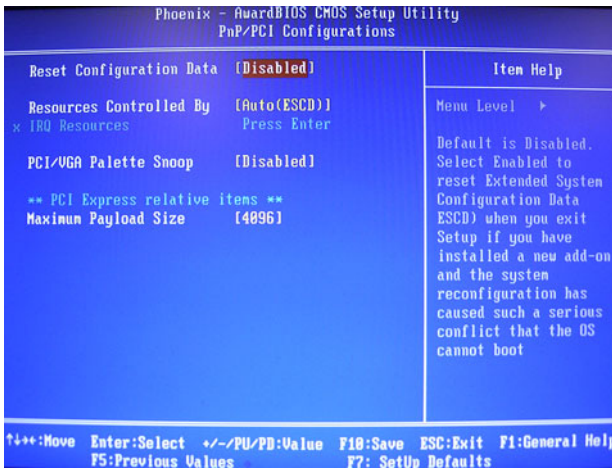

Figure 3.10: PnP/PCI configurations screen

3.8.1 Reset Configuration Data

The default is Disabled. Select Enabled to reset Extended System Configuration Data (ESCD) if you have installed a new add-on card, and system configuration is in such a state that the OS cannot boot.

3.8.2 Resources Controlled By

The commands here are “Auto(ESCD)” or “Manual”. Choosing “Manual” requires you to choose resources from the following sub-menu. “Auto(ESCD)” automatically configures all of the boot and Plug and Play devices, but you must be using Windows 95 or above.

3.8.3 PCI/VGA Palette Snoop

This is set to “Disabled” by default.

3.8.4 Maximum Payload Size

This allows you to set the maximum TLP payload size for PCI Express devices. The options are [128 bytes], [256 bytes], [512 bytes], [1024 bytes], [2048 bytes], and [4096 bytes].

3.9 PC Health Status

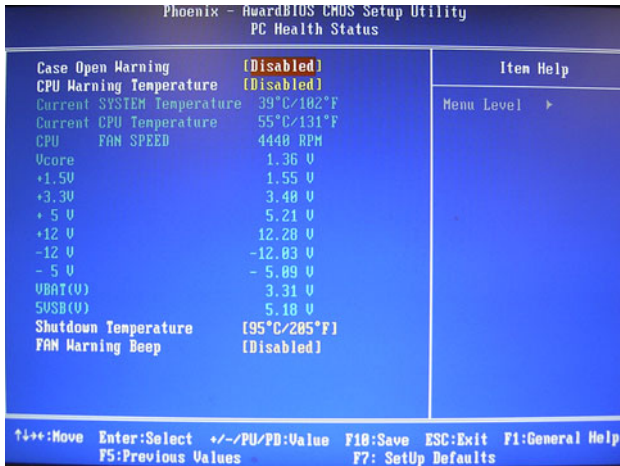

Figure 3.11: PC Health Status Screen

3.9.1 Case Open Warning

Enable this to detect if the case is open or closed.

3.9.2 CPU Warning Temperature

This item will prevent the CPU from overheating. The choices are “Disabled”, “60C/140F”, “63C/145F”, “66C/151F”, “70C/158F”, “75C/167F”, “80C/176F”, “85C/185F”, “90C/194F”, and “95C/205F”.

3.9.3 Current System Temperature

This shows you the current temperature of system.

3.9.4 Current CPU Temperature

This shows the current CPU temperature.

3.9.5 CPU FAN Speed

This shows the current CPU FAN operating speed.

3.9.6 System FAN Speed

This shows the current System FAN operating speed.

3.9.7 VCORE and Other Voltages

This shows the voltage of VCORE, +1.5V, VCC3, +5V, +12V, -12V, -5V, VBAT(V), and 5VSB(V).

3.9.8 Shutdown Temperature

The system will shut down automatically when the CPU temperature is over the selected setting. This function can prevent CPU damage caused by overheating.

3.10 Frequency / Voltage Control

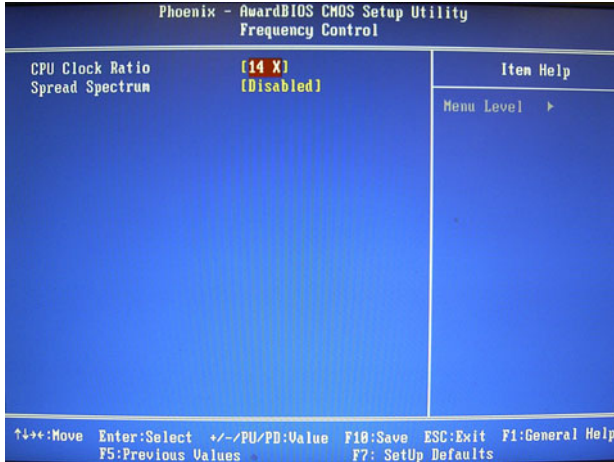

Figure 3.12: Spread Spectrum Control screen

3.10.1 CPU Clock Ratio

Type a DEC number to set up the CPU Clock Ratio (Min=14; Max=17). This item only shows up in special situations.

3.10.2 Spread Spectrum

This setting allows you to reduce EMI by modulating the signals the CPU generates so that the spikes are reduced to flatter curves. This is achieved by varying the frequency slightly so that the signal does not use any particular frequency for more than a moment. The choices are “Disabled” and “Enabled”.

3.11 Password Setting

Follow these steps to change the password.

1. Choose the “Set Password” option from the “Initial Setup Screen” menu and press <Enter>. The screen displays the following message:

Please Enter Your Password

2. Press <Enter>.
3. If the CMOS is good and this option has been used to change the default password, the user is asked for the password stored in the CMOS. The screen displays the following message:

Please Confirm Your Password

4. Type the current password and press <Enter>.
5. After pressing <Enter> (ROM password) or the current password (user-defined), you can change the password stored in the CMOS. The password must be no longer than eight (8) characters.

Remember, to enable the password setting feature, you must first select either “Setup” or “System” from the “Advanced BIOS Features” menu.

3.12 Save & Exit Setup

If you select this and press <Enter>, the values entered in the setup utilities will be recorded in the CMOS memory of the chipset. The processor will check this every time you turn your system on and compare this to what it finds as it checks the system. This record is required for the system to operate.

3.13 Exit Without Saving

Selecting this option and pressing <Enter> lets you exit the setup program without recording any new values or changing old ones.

CHAPTER
4

**Chipset Software
Installation Utility**

Chapter 4 Chipset Software Install Utility

4.1 Before you begin

To facilitate the installation of the enhanced display drivers and utility software, read the instructions in this chapter carefully. The drivers for the AIMB-760 are located on the software installation CD. The auto-run function of the driver CD will guide and link you to the utilities and drivers under a Windows system. The Intel® Chipset Software Installation Utility is not required on any systems running Windows NT 4.0. Updates are provided via Service Packs from Microsoft*.

Note: *The files on the software installation CD are compressed. Do not attempt to install the drivers by copying the files manually. You must use the supplied SETUP program to install the drivers.*

Before you begin, it is important to note that most display drivers need to have the relevant software application already installed in the system prior to installing the enhanced display drivers. In addition, many of the installation procedures assume that you are familiar with both the relevant software applications and operating system commands. Review the relevant operating system commands and the pertinent sections of your application software's user manual before performing the installation.

4.2 Introduction

The Intel® Chipset Software Installation (CSI) utility installs the Windows INF files that outline to the operating system how the chipset components will be configured. This is needed for the proper functioning of the following features:

- Core PCI PnP services
- IDE Ultra ATA 100/66/33 and Serial ATA interface support
- USB 1.1/2.0 support (USB 2.0 driver needs to be installed separately for Win98)
- Identification of Intel® chipset components in the Device Manager

- Integrates superior video features. These include filtered sealing of 720 pixel DVD content, and MPEG-2 motion compensation for software DVD

Note: *This utility is used for the following versions of Windows system, and it has to be installed before installing all the other drivers:*

- Windows 2000
- Windows XP

4.3 Windows XP Driver Setup

1. Insert the driver CD into your system's CD-ROM drive. In a few seconds, the software installation main menu appears. Move the mouse cursor over the “Auto” button under the “CSI UTILITY” heading. A message pops up telling you to install the CSI utility before other device drivers, as shown in the following figure. Click on this button. To take Windows XP as example.



2. Click “Next” when you see the following message.

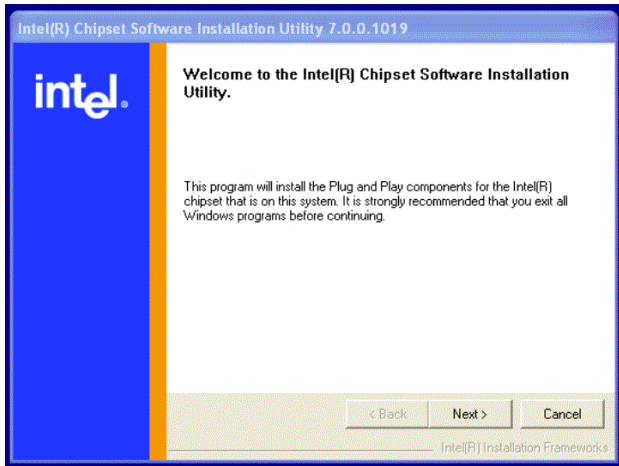

3. Click “Yes” when you see the following message.

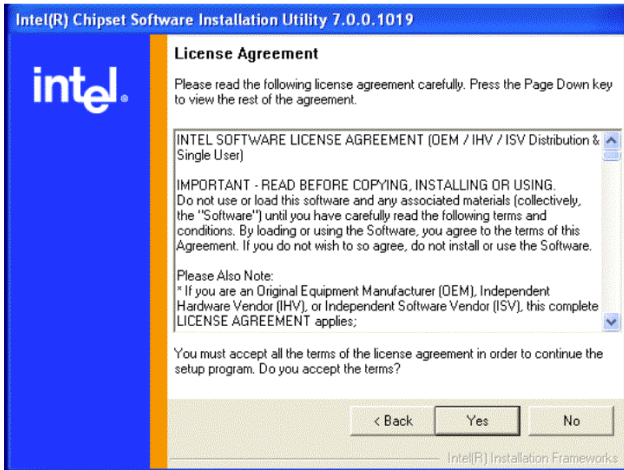

4. Click “Next” when you see the following message.

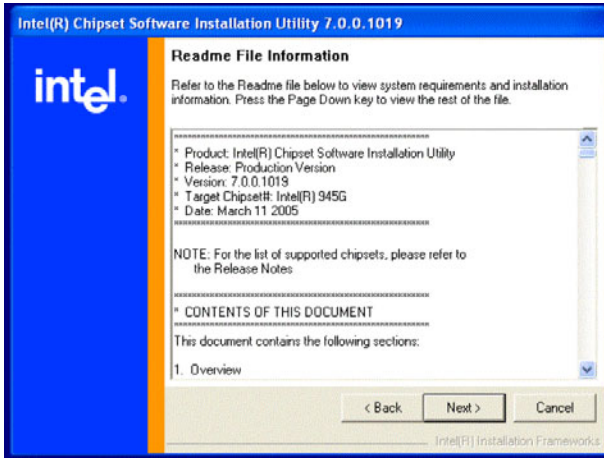

5. When the following message appears, click “Finish” to complete the installation and restart Windows.

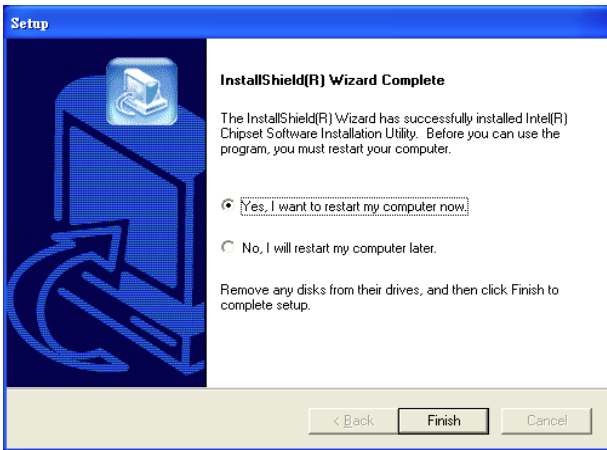

CHAPTER
5

VGA Setup

Chapter 5 VGA Setup

5.1 Introduction

The Intel 915GV integrated graphics controller provides an analog display port and DVI interface through SDVO ports. You need to install the VGA driver to enable the function.

The Intel 915GV integrated graphics controller includes the following features.

- **Intel Graphics Media Accelerator 900:** Incorporating the latest Microsoft* DirectX*9 support capabilities, it allows software developers to create lifelike environments and characters. Dual independent display, enhanced display modes for widescreen flat panels, and optimized 3D support deliver an intense and realistic visual experience without requiring a separate graphics card.
- **Intel Serial Digital Video Output (SDVO):** The AIMB-760 provides DVI interface through SDVO ports. It supports CRTs via a VGA connector with a maximum pixel clock of 400 MHz (up to 2048x1536 resolution @ 85 Hz refresh rate)

5.2 Windows XP Driver Setup

Note: *Before installing this driver, make sure the CSI utility has been installed in your system. See Chapter 4 for information on installing the CSI utility.*

Insert the driver CD into your system's CD-ROM drive. In a few seconds, the software installation main menu appears, as shown in the following figure.



The following installation procedure is for Windows XP. For other operating systems, please do a manual installation.

1. Click “Next” to continue the installation.

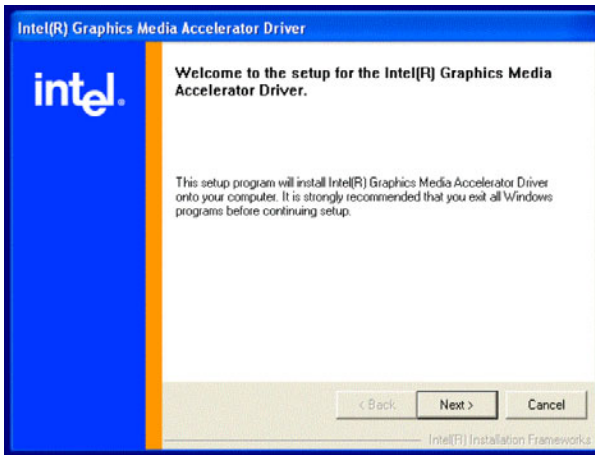

2. You will see a welcome window. Please click “Yes” to continue the installation.

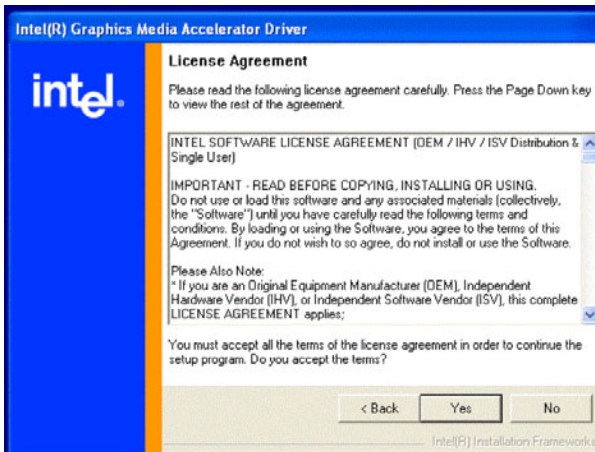

3. Click “Finish” to complete the installation and restart the computer now or later.



CHAPTER
6

**Onboard Security
Setup**

Chapter 6 Onboard Security Setup

6.1 Introduction

The AIMB-760's hardware monitor is based on the Winbond W83627HF chip. Onboard security (OBS) functions monitor key hardware to help you maintain system stability and durability. The AIMB-760 can monitor five sets of positive system voltages, two sets of system negative voltages, CPU cooling fan speed, and CPU temperature. The positive system voltage sets that can be monitored include:

- CPU core voltage: 1.3 ~ 3.3 V, according to Intel specifications.
- Transmission voltage from CPU to chipset: typically 1.8 V.
- Chipset voltage: typically 3.3 V.
- Main voltage: +5 V, +12 V.

The negative system voltage sets which can be monitored include:

- Main voltage: -5 V, -12 V.

6.2 Windows XP Driver Setup

1. Insert the driver CD into your system's CD-ROM drive. In a few seconds, the software installation main menu appears, as shown in the following figure. Click on the “Install” button under the “OB DRIVERS” heading.



2. Click “Next” when you see the following message.

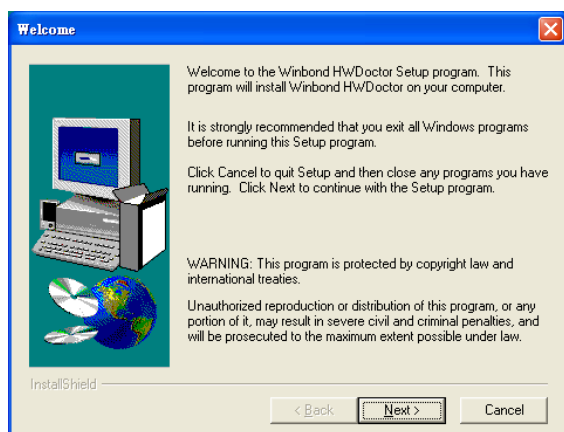

3. Click “Next” when you see the following message.

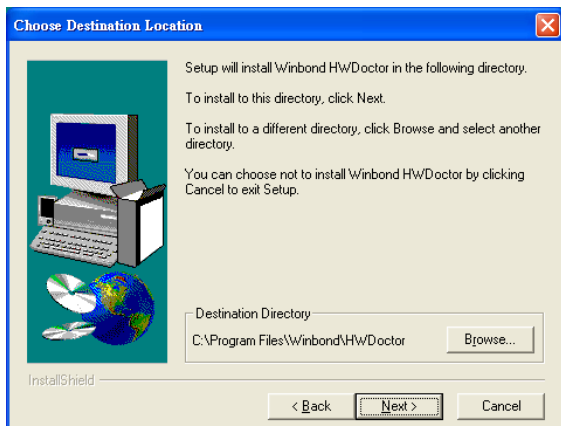

4. Click “Next” when you see the following message.

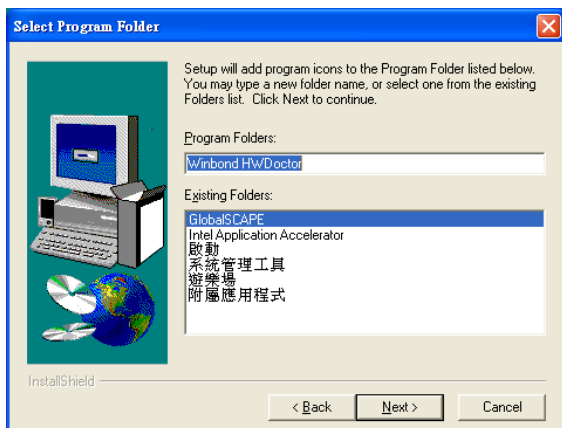

5. Click “Next” to continue.

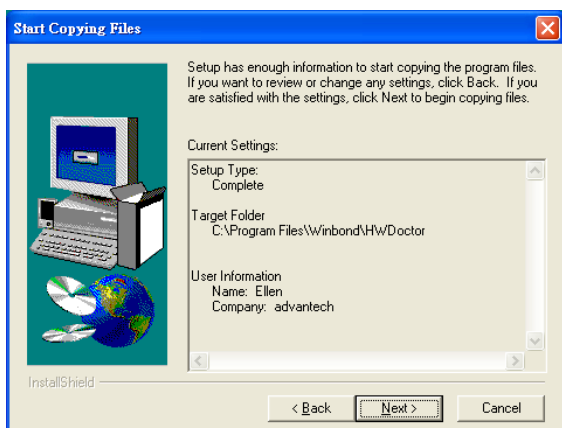

6. Click “Finish” when you see the following message.

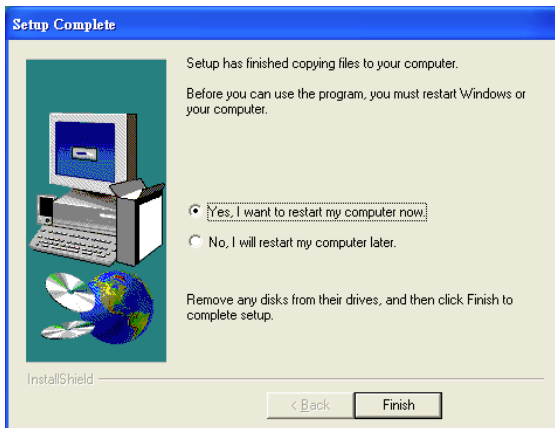

6.3 Using the OBS Hardware Doctor Utility

After completing the setup, all the OBS functions are permanently enabled. When a monitored reading exceeds safe limits, a warning message will be displayed and an error beep will sound to attract your attention.

OBS Hardware Doctor will show an icon on the right side of the bottom window bar. This icon is the “Terminate and Stay Resident” (TSR) icon. It will permanently remain in the bottom window bar, and will activate warning signals when triggered by the onboard security system.

You can view or change values for various OBS settings by following these steps.

From the desktop of Windows, click on “Start” and select “Programs”, select “Winbond HWDdoctor” and click “HWDOCTOR”. It is recommended that you load the default values for all the OBS settings. However, if desired, you can establish new conditions for voltage, fan speed, and temperature.

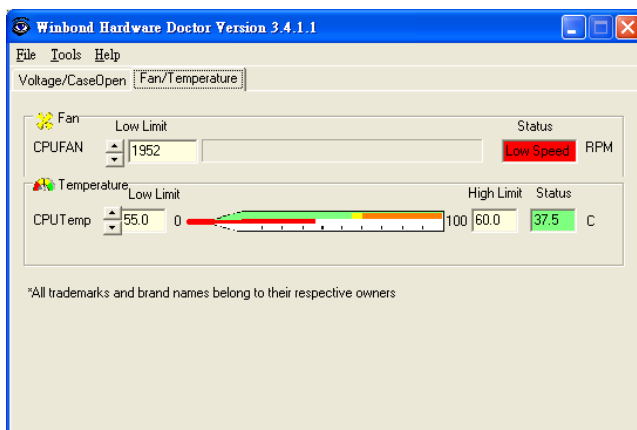
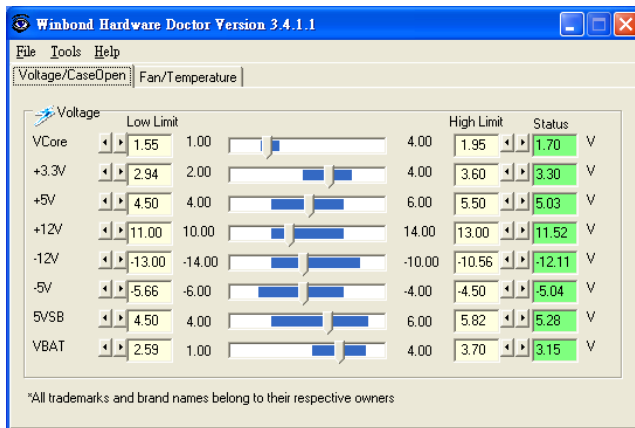

CHAPTER 7

LAN Configuration

Chapter 7 LAN Configuration

7.1 Introduction

The AIMB-760 features a single/dual Gigabit Ethernet network interface. With the Broadcom BCM5721 GbE controller built in, AIMB-760 uses the PCI Express host interface (PCI-E X1) for LAN connectivity with a maximum throughput of 2 Gbps for heavy-duty industrial network applications.

7.2 Features

- Integrated 10/100/100 BASE-T transceiver
- 10/100/1000 BASE-T triple-speed MAC
- High-speed RISC core with 24-KB cache
- On-chip voltage regulation
- Wake-on-LAN (WOL) support
- PCI Express X1 host interface

7.3 Installation

Note: *Before installing the LAN drivers, make sure the CSI utility has been installed on your system. See Chapter 4 for information on installing the CSI utility.*

The AIMB-760 Broadcom BCM5721 Gigabit integrated controller supports all major network operating systems. However, the installation procedure varies with different operating systems. In the following sections, refer to the one that provides the driver setup procedure for the operating system you are using.

7.4 Win XP Driver Setup (Broadcom BCM5721)

1. Insert the driver CD into your system's CD-ROM drive. In a few seconds, the software installation main menu appears, as shown in the following figure. Under the “LAN Drivers” heading, click on the “Manual” to open file manager, then click “SETUP.EXE” to run the installation procedure.



2. Click “Next” to continue the installation.

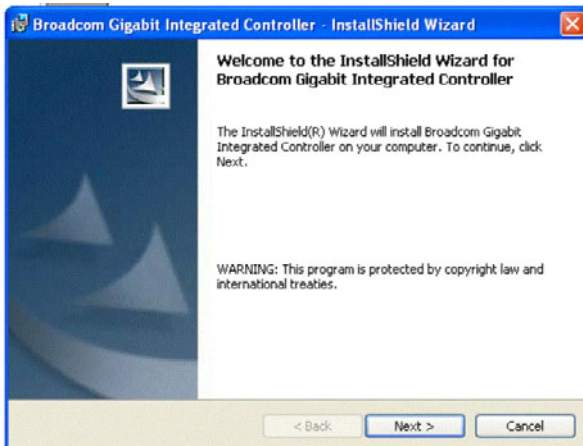

3. The license agreement appears. Click “Next” to continue the installation.

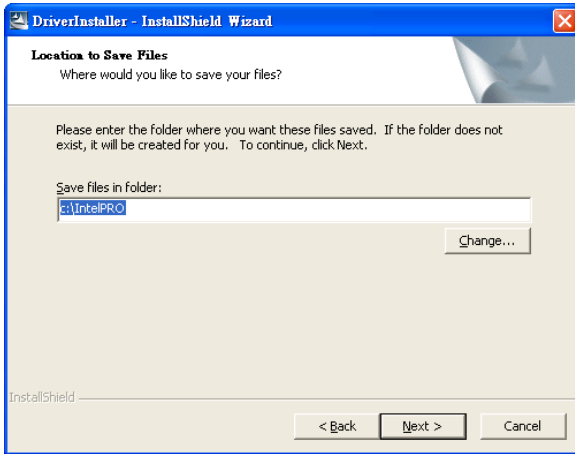

4. Click “Install” to continue.

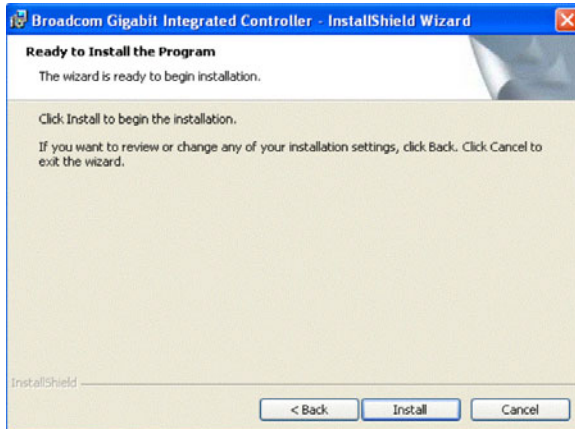

5. Click “Finish” to complete the installation.

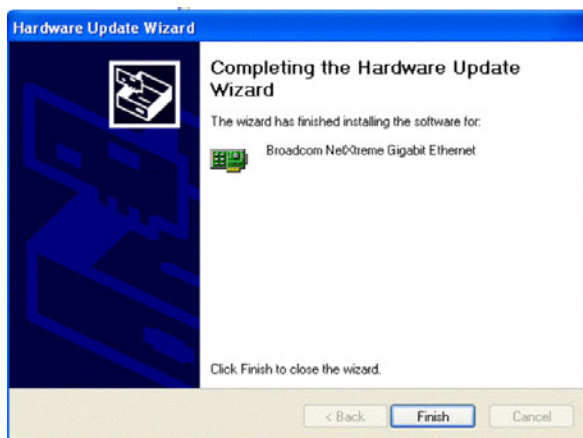

Appendix

A

Programming the Watchdog Timer

Appendix A Watchdog Timer

A.1 Programming the Watchdog Timer

The AIMB-760's watchdog timer can be used to monitor system software operation and take corrective action if the software fails to function within the programmed period. This section describes the operation of the watchdog timer and how to program it.

A.1.1 Watchdog timer overview

The watchdog timer is built in to the super I/O controller W83627HF. It provides the following functions for user programming:

- Can be enabled and disabled by user's program
- Timer can be set from 1 to 255 seconds or 1 to 255 minutes
- Generates an interrupt or resets signal if the software fails to reset the timer before time-out

A.1.2 Reset/Interrupt selection

The J2 jumper is used to select reset or interrupt (IRQ 11) in the event the watchdog timer is tripped. See Chapter 1 for detailed jumper settings.

Note: *The interrupt output of the watchdog timer is a low level signal. It will be held low until the watchdog timer is reset.*

A.1.3 Programming the Watchdog Timer

The I/O port address of the watchdog timer is 2E(hex) and 2F(hex). 2E (hex) is the address port. 2F(hex) is the data port. You must first assign the address of register by writing an address value into address port 2E (hex), then write/read data to/from the assigned register through data port 2F (hex).

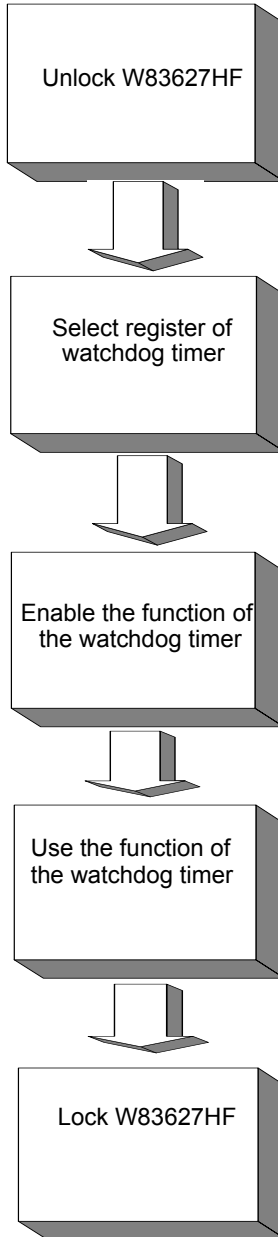

Table A.1: Watchdog timer registers

Address of register (2E)	Attribute	
Read/Write	Value (2F) & description	
87 (hex)	----	Write this address to I/O address port 2E (hex) twice to unlock the W83627HF
07 (hex)	write	Write 08 (hex) to select register of watchdog timer.
30 (hex)	write	Write 01 (hex) to enable the function of the watchdog timer. Disabled is set as default.
F5 (hex)	write	Set seconds or minutes as units for the timer.
Write 0 to bit 3: set second as counting unit. [default]		
Write 1 to bit 3: set minutes as counting unit		
F6 (hex)	write	0: stop timer [default] 01~FF (hex): The amount of the count, in seconds or minutes, depends on the value set in register F5 (hex). This number decides how long the watchdog timer waits for strobe before generating an interrupt or reset signal. Writing a new value to this register can reset the timer to count with the new value.
F7 (hex)	read/write	Bit 6: Write 1 to enable keyboard to reset the timer, 0 to disable.[default] Bit 5: Write 1 to generate a timeout signal immediately and automatically return to 0. [default=0] Bit 4: Read status of watchdog timer, 1 means timer is "timeout".
AA (hex)	----	Write this address to I/O port 2E (hex) to lock the watchdog timer 2.

A.1.4 Example Program

1. Enable watchdog timer and set 10 sec. as timeout interval

```
;-----  
Mov dx,2eh          ; Unlock W83627HF  
Mov al,87h  
Out dx,al  
Out dx,al  
;-----  
Mov al,07h         ; Select registers of watchdog timer  
Out dx,al  
Inc dx  
Mov al,08h  
Out dx,al  
;-----  
Dec dx             ; Enable the function of watchdog timer  
Mov al,30h  
Out dx,al  
Inc dx  
Mov al,01h  
Out dx,al  
;-----  
Dec dx             ; Set second as counting unit  
Mov al,0f5h  
Out dx,al  
Inc dx  
In al,dx  
And al,not 08h  
Out dx,al  
;-----  
Dec dx             ; Set timeout interval as 10 seconds and start counting  
Mov al,0f6h  
Out dx,al
```

```
Inc dx
Mov al,10
Out dx,al
```

```
-----
```

```
Dec dx ; lock W83627HF
Mov al,0aah
Out dx,al
```

2. Enable watchdog timer and set 5 minutes as timeout interval

```
-----
```

```
Mov dx,2eh ; unlock W83627HF
Mov al,87h
Out dx,al
Out dx,al
```

```
-----
```

```
Mov al,07h ; Select registers of watchdog timer
Out dx,al
Inc dx
Mov al,08h
Out dx,al
```

```
-----
```

```
Dec dx ; Enable the function of watchdog timer
Mov al,30h
Out dx,al
Inc dx
Mov al,01h
Out dx,al
```

```
-----
```

```
Dec dx ; Set minute as counting unit
Mov al,0f5h
Out dx,al
Inc dx
```

```

In  al,dx
Or  al,08h
Out dx,al
;-----
Dec dx          ; Set timeout interval as 5 minutes and start counting
Mov al,0f6h
Out  dx,al
Inc  dx
Mov  al,5
Out  dx,al
;-----
Dec dx          ; lock W83627HF
Mov  al,0aah
Out  dx,al
3.   Enable watchdog timer to be reset by mouse
;-----
Mov dx,2eh      ; unlock W83627HF
Mov  al,87h
Out  dx,al
Out  dx,al
;-----
Mov al,07h      ; Select registers of watchdog timer
Out  dx,al
Inc  dx
Mov  al,08h
Out  dx,al
;-----
Dec dx          ; Enable the function of watchdog timer
Mov  al,30h
Out  dx,al
Inc  dx

```

```

Mov al,01h
Out dx,al
;-----
Dec dx          ; Enable watchdog timer to be reset by mouse
Mov al,0f7h
Out dx,al
Inc dx
In al,dx
Or al,80h
Out dx,al
;-----
Dec dx          ; lock W83627HF
Mov al,0aah
Out dx,al
4. Enable watchdog timer to be reset by keyboard
;-----
Mov dx,2eh      ; unlock W83627HF
Mov al,87h
Out dx,al
Out dx,al
;-----
Mov al,07h      ; Select registers of watchdog timer
Out dx,al
Inc dx
Mov al,08h
Out dx,al
;-----
Dec dx          ; Enable the function of watchdog timer
Mov al,30h
Out dx,al
Inc dx

```

```

Mov al,01h
Out dx,al
;-----
Dec dx          ; Enable watchdog timer to be strobed reset by keyboard
Mov al,0f7h
Out dx,al
Inc dx
In al,dx
Or al,40h
Out dx,al
;-----
Dec dx          ; lock W83627HF
Mov al,0aah
Out dx,al
5.   Generate a time-out signal without timer counting
;-----
Mov dx,2eh     ; unlock W83627HF
Mov al,87h
Out dx,al
Out dx,al
;-----
Mov al,07h     ; Select registers of watchdog timer
Out dx,al
Inc dx
Mov al,08h
Out dx,al
;-----
Dec dx          ; Enable the function of watchdog timer
Mov al,30h
Out dx,al
Inc dx

```

```

Mov al,01h
Out dx,al
;-----
Dec dx          ; Generate a time-out signal
Mov al,0f7h
Out dx,al      ;Write 1 to bit 5 of F7 register
Inc dx
In al,dx
Or al,20h
Out dx,al
;-----
Dec dx          ; lock W83627HF
Mov al,0aah
Out dx,al

```

Appendix

B

I/O Pin Assignments

Appendix B Pin Assignments

B.1 IDE Hard Drive Connector (CN1)

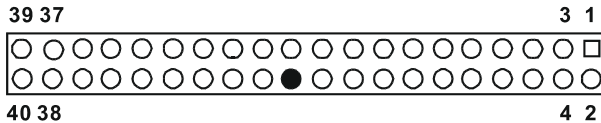

Table B.1: IDE hard drive connector (CN1)

Pin	Signal	Pin	Signal
1	IDE RESET*	2	GND
3	DATA 7	4	DATA 8
5	DATA 6	6	DATA 9
7	DATA 5	8	DATA 10
9	DATA 4	10	DATA 11
11	DATA 3	12	DATA 12
13	DATA 2	14	DATA 13
15	DATA 1	16	DATA 14
17	DATA 0	18	DATA 15
19	SIGNAL GND	20	N/C
21	DISK DMA REQUEST	22	GND
23	IO WRITE	24	GND
25	IO READ	26	GND
27	IO CHANNEL READY	28	CSEL
29	HDACKO*	30	GND
31	IRQ14	32	IDSC16-
33	ADDR 1	34	PDIAG
35	ADDR 0	36	ADDR 2
37	HARD DISK SELECT 0*	38	HARD DISK SELECT 1*
39	IDE ACTIVE*	40	GND

* low activity

B.2 Floppy Drive Connector (CN3)

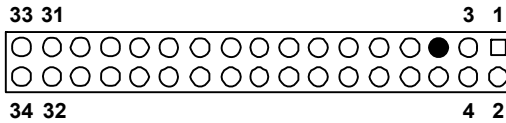

Table B.2: Floppy drive connector (CN3)

Pin	Signal	Pin	Signal
1	GND	2	FDHDIN*
3	GND	4	N/C
5	N/C	6	FDEDIN*
7	GND	8	INDEX*
9	GND	10	MOTOR 0*
11	GND	12	DRIVE SELECT 1*
13	GND	14	DRIVE SELECT 0*
15	GND	16	MOTOR 1*
17	GND	18	DIRECTION*
19	GND	20	STEP*
21	GND	22	WRITE DATA*
23	GND	24	WRITE GATE*
25	GND	26	TRACK 0*
27	GND	28	WRITE PROTECT*
29	GND	30	READ DATA*
31	GND	32	HEAD SELECT*
33	GND	34	DISK CHANGE*

* low activity

B.3 Parallel Port (CN4)

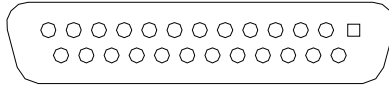

Table B.3: Parallel Port (CN4)

Pin	Signal	Pin	Signal
1	STROBE*	14	AUTOFD*
2	D0	15	ERR
3	D1	16	INIT*
4	D2	17	SLCTINI*
5	D3	18	GND
6	D4	19	GND
7	D5	20	GND
8	D6	21	GND
9	D7	22	GND
10	ACK*	23	GND
11	BUSY	24	GND
12	PE	25	GND
13	SLCT	26	N/C

* low activity

B.4 USB Header (CN6/CN63)

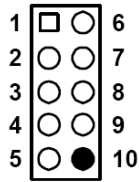

Table B.4: USB Header (CN6/CN63)

Pin	Signal	Pin	Signal
1	USB0_VCC5	6	USB1_D+
2	USB1_VCC5	7	GND
3	USB0_D-	8	GND
4	USB1_D-	9	Key
5	USB0_D+	10	GND

B.5 VGA Connector (CN7)

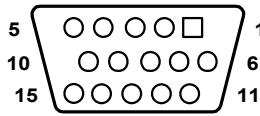

Table B.5: VGA Connector (CN7)

Pin	Signal	Pin	Signal
1	RED	9	VCC
2	GREEN	10	GND
3	BLUE	11	N/C
4	N/C	12	SDT
5	GND	13	H-SYNC
6	GND	14	V-SYNC
7	GND	15	SCK

B.6 RS-232 Interface (CN9/10)

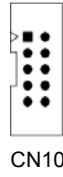
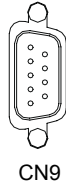

Table B.6: RS-232 Interface (CN9/10)

Pin	Signal
1	DCD
2	RXD
3	TXD
4	DTR
5	GND
6	DSR
7	RTS
8	CTS
9	RI

B.7 PS/2 Keyboard and Mouse Connector (CN11)



Table B.7: Keyboard and Mouse Connector (CN11)

Pin	Signal
1	KB DATA
2	N/C
3	GND
4	KB VCC
5	KB CLK
6	N/C

B.8 External Keyboard Connector (CN12)

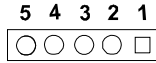

Table B.8: External Keyboard Connector (CN12)

Pin	Signal
1	CLK
2	DATA
3	NC
4	GND
5	VCC

B.9 Infrared (IR) connector (CN13)

Table B.9: Infrared Connector (CN13)

Pin	Signal
1	VCC
2	N/C
3	IRRX
4	GND
5	IRTX

B.10 CPU/System Fan Power Connector (CN14/15/37)



Table B.10: Fan Power Connector (CN14/15/37)

Pin	Signal
1	GND
2	+12V
3	DETECT

B.11 Power LED and Keyboard Lock (CN16)

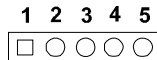

Table B.11: Power LED and Keyboard Lock (CN16)

Pin	Function
1	LED power (+5 V)
2	NC
3	GND
4	NC
5	GND

B.12 External Speaker Connector (CN17)

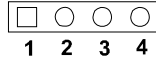

Table B.12: External Speaker Connector (CN17)

Pin	Function
1	Buzzer
2	NC
3	Buzzer
4	Speaker out

B.13 Reset Connector (CN18)



Table B.13: Reset Connector (CN18)

Pin	Signal
1	RESET
2	GND

B.14 HDD LED Connector (CN19)



Table B.14: HDD LED Connector (CN19)

Pin	Signal
1	VCC (LED+)
2	IDE LED (LED-)

B.15 ATX Soft Power Switch (CN21)



Table B.15: ATX Soft Power Switch (CN21)

Pin	Signal
1	5VSB
2	PWR-BTN

B.16 H/W Monitor Alarm (CN22)



Table B.16: H/W Monitor Alarm (CN22)

Pin	Signal
1	Enable OBS alarm
2	Disable OBS alarm

B.17 SM Bus Connector (CN29)



Table B.17: SM Bus Connector (CN 29)

Pin	Signal
1	SMB_DATA
2	SMB_CLK

B.18 USB/LAN ports (CN31 and CN32)

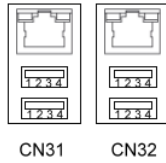

Table B.18: USB Port

Pin	Signal	Pin	Signal
1	VCC	3	Data0+
2	Data0-	4	GND

Table B.19: Ethernet 10/100Base-T RJ-45 port

Pin	Signal	Pin	Signal
1	XMT+	5	N/C
2	XMT-	6	RCV-
3	RCV+	7	N/C
4	N/C	8	N/C

B.19 Line Out, Mic IN Connector (CN55)

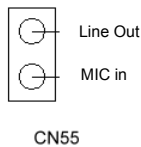

B.20 Audio Input from CD-ROM (CD IN; CN56)



Table B.20: Audio Input from CD-ROM

Pin	Signal	Pin	Signal
1	CD_L	3	GND
2	GND	4	CD_R

B.21 Aux Line-In Connector (CN57)



Table B.21: Aux Line-In Connector (CN57)

Pin	Signal	Pin	Signal
1	AUX_L	3	GND
2	GND	4	AUX_R

B.22 Front Panel Audio Connector (FP AUDIO; CN59)

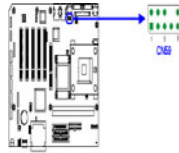
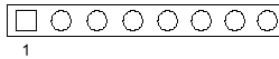

Table B.22: Audio Connector (FP AUDIO; CN59)

Pin	Signal	Pin	Signal
1	MIC	6	LOUT_RR
2	GND	7	NC
3	MIC_BIAS	8	NC
4	VCC	9	LOUT_L
5	LOUT_R	10	LOUT_LL

B.23 8-pin Alarm Board Connector (CN62)



CN62

Table B.23: 8-pin Alarm Board Connector (CN62)

Pin	Signal	Pin	Signal
1	5VSB	5	VCC
2	GND	6	VCC3
3	GND	7	-12V
4	-5V	8	+12V

B.24 Case Open Connector (CN64)



Table B.24: Case Open Connector (CN64)

Pin	Signal
1	CASEOP
2	GND

B.25 Front Panel LAN LED Connector (CN65)

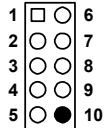

Table B.25: LAN LED Connector (CN65)

Pin	Signal	Pin	Signal
1	LAN1_LINK	2	LAN2_LINK
3	LAN1_ACT	4	LAN2_ACT
5	LAN1_LINK100 0	6	LAN2_LINK100 0
7	LAN1_LINK100	8	LAN2_LINK100
9	3VDUAL	10	N/C

B.26 System I/O Ports

Table B.26: System I/O ports

Addr. range (Hex)	Device
000-01F	DMA controller
020-021	Interrupt controller 1, master
022-023	Chipset address
040-05F	8254 timer
060-06F	8042 (keyboard controller)
070-07F	Real-time clock, non-maskable interrupt (NMI) mask
080-09F	DMA page register
0A0-0BF	Interrupt controller 2
0C0-0DF	DMA controller
0F0	Clear math co-processor
0F1	Reset math co-processor
0F8-0FF	Math co-processor
1F0-1F8	Fixed disk
200-207	Game I/O
278-27F	Parallel printer port 2 (LPT3)
290-297	On-board hardware monitor
2F8-2FF	Serial port 2
300-31F	Prototype card
360-36F	Reserved
378-37F	Parallel printer port 1 (LPT2)
380-38F	SDLC, bisynchronous 2
3A0-3AF	Bisynchronous 1
3B0-3BF	Monochrome display and printer adapter (LPT1)
3C0-3CF	Reserved
3D0-3DF	Color/graphics monitor adapter
3F0-3F7	Diskette controller
3F8-3FF	Serial port 1

B.27 DMA Channel Assignments

Table B.27: DMA channel assignments

Channel	Function
0	Available
1	Available
2	Floppy disk (8-bit transfer)
3	Available
4	Cascade for DMA controller 1
5	Available
6	Available
7	Available

B.28 Interrupt Assignments

Table B.28: Interrupt assignments

Priority	Interrupt#	Interrupt source
1	NMI	Parity error detected
2	IRQ0	Interval timer
3	IRQ1	Keyboard
-	IRQ2	Interrupt from controller 2 (cascade)
4	IRQ8	Real-time clock
5	IRQ9	Cascaded to INT 0A (IRQ 2)
6	IRQ10	Available
7	IRQ11	Available
8	IRQ12	PS/2 mouse
9	IRQ13	INT from co-processor
10	IRQ14	Primary IDE Channel
11	IRQ15	Secondary IDE Channel
12	IRQ3	Serial communication port 2
13	IRQ4	Serial communication port 1
14	IRQ5	Parallel port 2
15	IRQ6	Diskette controller (FDC)
16	IRQ7	Parallel port 1 (print port)

B.29 1st MB Memory Map

Table B.29: 1st MB memory map

Addr. range (Hex)	Device
E0000h - FFFFFh	BIOS
CC000h - DFFFFh	Unused
C0000h - CBFFFh	VGA BIOS
A0000h - BFFFFh	Video Memory
00000h - 9FFFFh	Base memory

Free Manuals Download Website

<http://myh66.com>

<http://usermanuals.us>

<http://www.somanuals.com>

<http://www.4manuals.cc>

<http://www.manual-lib.com>

<http://www.404manual.com>

<http://www.luxmanual.com>

<http://aubethermostatmanual.com>

Golf course search by state

<http://golfingnear.com>

Email search by domain

<http://emailbydomain.com>

Auto manuals search

<http://auto.somanuals.com>

TV manuals search

<http://tv.somanuals.com>