

WELL-X-TROL® WELL-X1™



INSTALLER: LEAVE THIS MANUAL WITH THE OWNER

IMPORTANT GENERAL SAFETY INFORMATION - ADDITIONAL SPECIFIC SAFETY ALERTS APPEAR IN THE FOLLOWING INSTRUCTIONS.

⚠ WARNING READ CAREFULLY THE PRODUCT INSTALLATION, OPERATING AND MAINTENANCE MANUAL. FAILURE TO FOLLOW THE INSTRUCTIONS AND WARNINGS IN THE MANUAL MAY RESULT IN SERIOUS OR FATAL INJURY AND/OR PROPERTY DAMAGE, AND WILL VOID THE PRODUCT WARRANTY. THIS PRODUCT MUST BE INSTALLED BY A QUALIFIED PROFESSIONAL. FOLLOW ALL APPLICABLE LOCAL AND STATE CODES AND REGULATIONS, IN THE ABSENCE OF SUCH CODES, FOLLOW THE CURRENT EDITIONS OF THE NATIONAL PLUMBING CODE AND NATIONAL ELECTRIC CODE, AS APPLICABLE.

⚠ This is the safety alert symbol. It is used to alert you to personal injury hazards. Obey all safety instructions that follow this symbol to reduce the risk of possible injury or death as well as property damage.

1. TABLE OF CONTENTS

GENERAL SAFETY INFORMATION	2
COMPONENTS	3
INSTALLATION AND SIZING CONSIDERATIONS.....	4
INSTALLATION CONSIDERATIONS.....	5
PLUMBING	6
WIRING	8
STARTUP & ADJUSTMENT	9
PUMP PROTECTION & DIAGNOSTICS.....	13
TROUBLESHOOTING	14
REPLACEMENT PARTS	15

2. GENERAL SAFETY INFORMATION

▲ WARNING This Product, like most Products under pressure, may over time corrode, weaken and burst or explode, causing serious or fatal injury, leaking or flooding and/or property damage. To minimize risk, a licensed professional must install and periodically inspect and service the Product. A drip pan connected to an adequate drain must be installed if leaking or flooding could cause property damage. Do not locate in an area where leakage of the tank or connections could cause property damage to the area adjacent to the appliance or to lower floors of the structure.

▲ WARNING **Chlorine & Aggressive Water:** The water quality can significantly influence the life of this Product. You should test for corrosive elements, acidity, total solids and other relevant contaminants, including chlorine and treat your water appropriately to insure satisfactory performance and prevent premature failure.

NOTE: Inspect for shipping damage and notify freight carrier or store where purchased immediately if damage is present. To avoid risk of personal injury and property damage, if the product appears to be malfunctioning or shows signs of corrosion, call a qualified professional immediately. Current copies of the Product manual can be viewed at www.amtrol.com. Use proper safety equipment when installing.

ELECTROCUTION AND EXPLOSION HAZARD! Before work is performed on the Product, turn off the power to the Product and release all pressure in the system.

▲ CAUTION As in all plumbing products and water storage vessels, bacteria can grow in this Product, especially during times of non-use. Consult your local plumbing professional regarding any steps you may wish to take to safely disinfect your home's plumbing system.

▲ WARNING **DANGER! EXPLOSION HAZARD, WHEN THE WELL-X1™ HAS BEEN IN SERVICE AND A CHANGE TO A HIGHER PRE-CHARGE PRESSURE IS NECESSARY DUE TO A REQUIRED CHANGE IN THE PRESSURE SWITCH SETTING, FAILURE TO FOLLOW INSTRUCTION MANUAL CAN CAUSE A RUPTURE OR EXPLOSION, POSSIBLY CAUSING SERIOUS OR FATAL INJURY, AND/OR PROPERTY DAMAGE. • DO NOT ADJUST THE PRE-CHARGE PRESSURE IF THERE HAS BEEN A REDUCTION OF THE PUMP CYCLE TIME OR THE PRE-CHARGE PRESSURE COMPARED TO ITS INITIAL SETTING. THIS IS BECAUSE REDUCTION IN**

PUMP CYCLE TIME CAN RESULT FROM LOSS OF TANK AIR PRESSURE WHICH IN TURN CAN MEAN THERE MAY BE INTERNAL CORROSION AND ANY RE-PRESSURIZATION OR ADDITIONAL PRESSURE COULD RESULT IN RUPTURE OR EXPLOSION, AND/OR PROPERTY DAMAGE.

▲ WARNING **RELIEF VALVE REQUIRED.** A relief valve has been installed which is set to open at excessive pressures (100 psig or more). This will protect the Well-X1™ and other system components should the pressure switch malfunction and fail to shut the pump off. The relief valve is installed at the connection of the Well-X1™ to the system piping.

▲ DANGER Before attempting any service and disassembly, shut off power to the pump. Ensure power is disconnected prior to removing motor. Ensure power is disconnected before cleaning is attempted.

▲ WARNING This control is capable of running pumps to pressures that may exceed the limitations of system components. Never set the operation pressure higher than that of the safe system capacity.

▲ WARNING This control can be adjusted to a narrow pressure differential. This can cause the pump to cycle rapidly with an improperly sized tank, leading to pump damage. This may require a larger pressure tank than normally used.

▲ WARNING **CALIFORNIA PROPOSITION 65 WARNING:** This product contains a chemical known by the State of California to cause cancer and to cause birth defects or other reproductive harm. (California Installer/Contractor - California law requires that this notice be given to consumer/end user of this product.) **For more information:** www.amtrol.com/prop65/htm

▲ WARNING Every Well-X1™ is air tested to 125 psig, the maximum working pressure for the Well-X1™.

▲ WARNING The pump controller is not a disconnect. The pump may be activated at any time. The electrical system must be considered energized at all times unless the circuit breaker is open. The disconnect for the controller must break all incoming power lines. As with a mechanical pressure switch, when installed with three wire 230 vac pumps or any 3-phase pump, a standard pump motor starter or a relay must be used.

3. COMPONENTS

The Well-X1™ combines all the standard well tank components in a single, easy to install package. The pressure tank, control and tank fittings are factory-installed. After removing from the cart, inspect the Well-X1™ for damage and ensure all components are present.

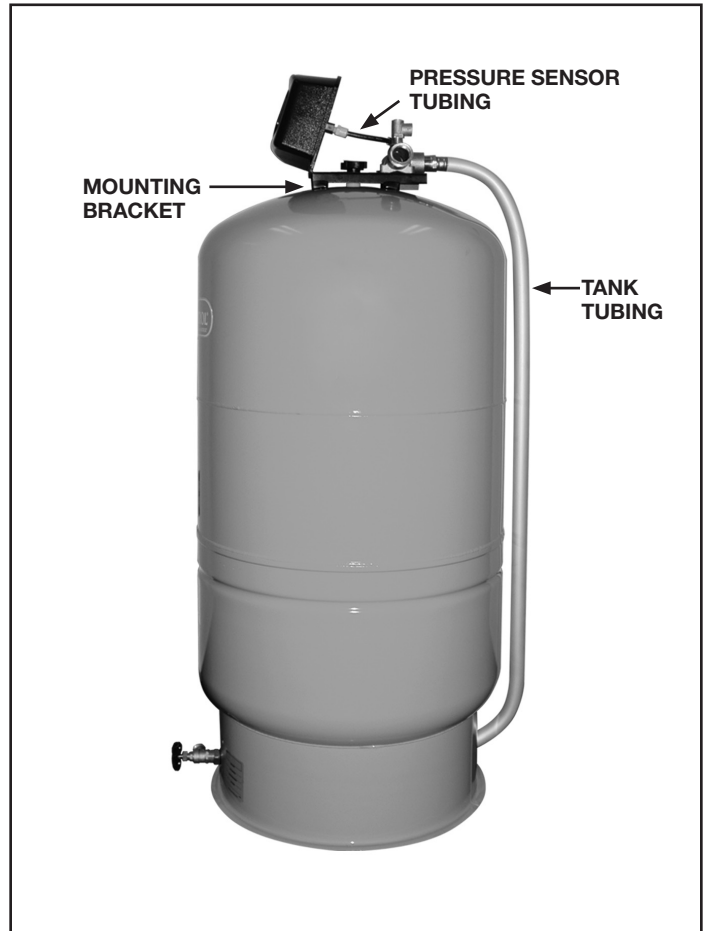
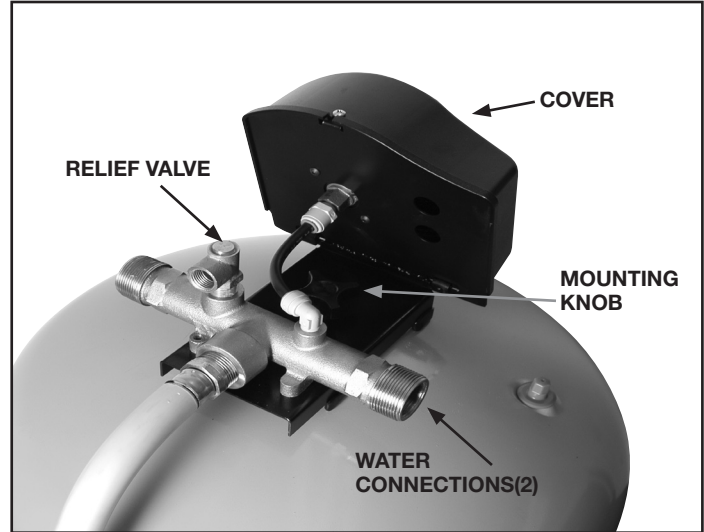
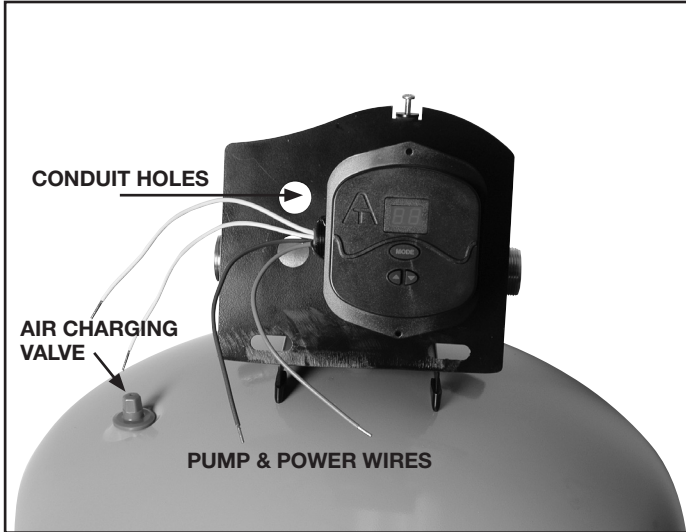

4. INSTALLATION AND SIZING CONSIDERATIONS

The Well-X1™ functions like a traditional pressure switch by cycling the pump on and off. The factory pressure settings are 40 psi cut-in and 60 psi cut-out. The controller allows these settings to be adjusted to best suit the application. The Well-X1™ can operate in two primary modes:

A. STANDARD OPERATION

Using a standard 20 psi differential, the Well-X1™ can be sized according to the chart below. In this application, the sizing and performance will be similar to a traditional pressure tank and mechanical switch combination.

WELL-X1™ SELECTION FOR STANDARD SYSTEMS					
Control Setting (cut-in/cut-out) (psi)					
		30/50	40/60	50/70	60/80
PUMP GPM	4	WX1-202	WX1-202	WX1-202	WX1-202
	5	WX1-202	WX1-202	WX1-202	WX1-203
	7	WX1-203	WX1-203	WX1-203	WX1-203
	10	WX1-203	WX1-250	WX1-250	WX1-251
	12	WX1-250	WX1-250	WX1-251	WX1-251
	15	WX1-251	WX1-251	WX1-302	WX1-302
	18	WX1-251	WX1-302	WX1-302	WX1-302
	20	WX1-302	WX1-302	WX1-302	-

B. CONSTANT PRESSURE MODE

The Well-X1™ control allows a narrow differential to provide consistent water pressure. The factory 20 psi differential can be reduced so the cut-in and cut-out pressures are within 10 psi. When installed as a constant pressure system, the chart below should be used to ensure the tank volume is sufficient to provide adequate cycle protection.

WELL-X1™ SELECTION FOR CONSTANT PRESSURE					
Control Setting (cut-in/cut-out) (psi)					
		40/50	50/60	60/70	70/80
PUMP GPM	4	-	WX1-203	WX1-203	WX1-203
	5	WX1-203	WX1-203	WX1-250	WX1-250
	7	WX1-250	WX1-250	WX1-251	WX1-251
	10	WX1-251	WX1-251	WX1-302	WX1-302
	12	WX1-251	WX1-302	WX1-302	WX1-302
	15	WX1-302	WX1-302	-	-

⚠ WARNING The maximum working pressure of the Well-X1™ is 125 psig. Do not exceed the maximum working pressure.

5. INSTALLATION CONSIDERATIONS

LOCATION

The Well-X1™ is designed for indoor and outdoor installations. The NEMA 3R enclosure can be installed in direct weather. If installed outdoors, be sure the following conditions are met:

- Do not install where ambient temperatures can drop below freezing or exceed 120° F.
- Ensure a Tuf Kote™ model is selected (Example: WX1-302TK) for outdoor installations. This proprietary coating is specifically designed to withstand outdoor applications.
- Use water-tight: wiring conduit, wire nuts and conduit connections as dictated by applicable codes and ordinances.
- Protect the piping from mechanical damage.
- Install the relief valve blow down tube where venting water will not cause personal injury or damage the surrounding property.
- Drip Pan and Drain: To avoid leaking and/or property damage, install with a drip pan connected to an adequate working drain kept clear at all times.

ORIENTATION

Ensure the installation meets all applicable local codes and is installed by a qualified professional. Additionally, the following should be noted.

- This unit is designed for vertical installation above ground only. Do not install horizontally or directly bury the unit. The Well-X1™ may be installed below grade in a well pit or other suitable enclosure. Do not locate in an area where leaking or flooding could cause property damage to surrounding areas.
- Check codes to determine if there are any height requirements pertaining to the Well-X1™. Particularly, ensure the bottom drain meets these requirements. If restrictions are imposed on the proximity of drain connections to the floor, the unit may be elevated on blocks or the bottom drain tube can be removed and plugged, after which a sampling tap may be installed in the water lines near the top of the Well-X1™.

6. PLUMBING

1. Plumbing connections are similar to a traditional "tank cross" or "tank tee". Provisions are made for popular line sizes via a 1-1/4" NPT male outer thread and a 1" NPT female inner thread. The plumbing connections are not directional and allow flow from either side. When attaching valves or fittings, uses the wrench flats provided.

⚠ WARNING EXPLOSION HAZARD. Failure to follow these instructions can cause a rupture or explosion possibly causing serious or fatal injury, flooding, and/or property damage.

2. Install the supply piping from the well pump. If required, install a spring-loaded check valve.

3. Install a shutoff (service) valve on the outgoing line. This will allow the Well-X1™ to be tested prior to pressurizing the entire system. DO NOT place a shutoff on the incoming supply line.

NOTE: The relief valve is sized for a maximum flow rate of 10 gpm at 125 psi. If the pump installation allows higher flow rates, an additional relief valve must be installed.

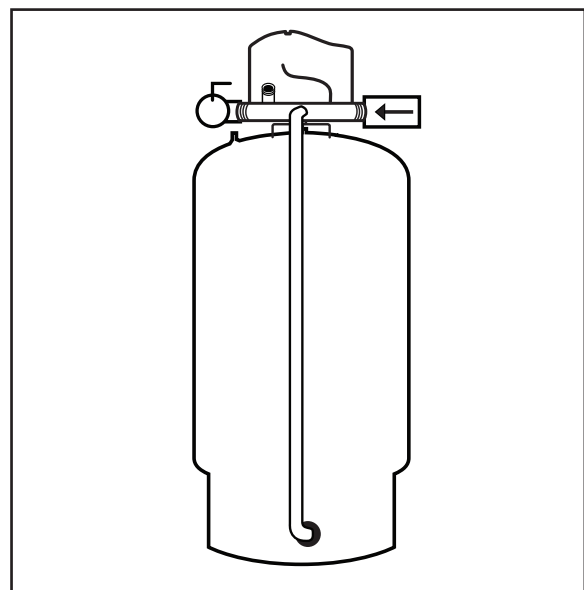
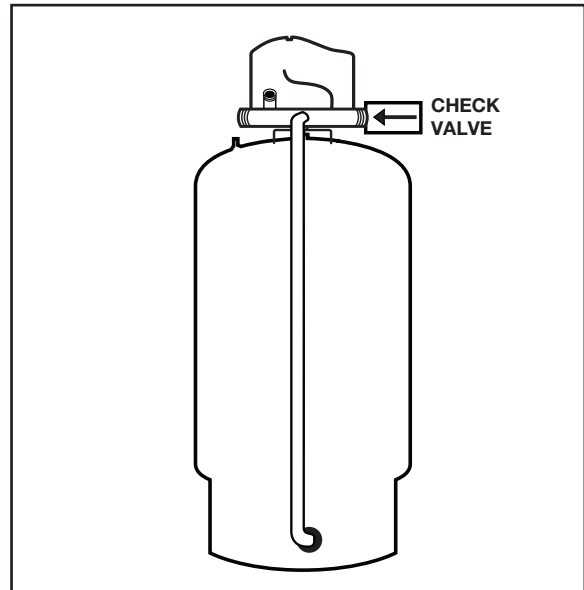
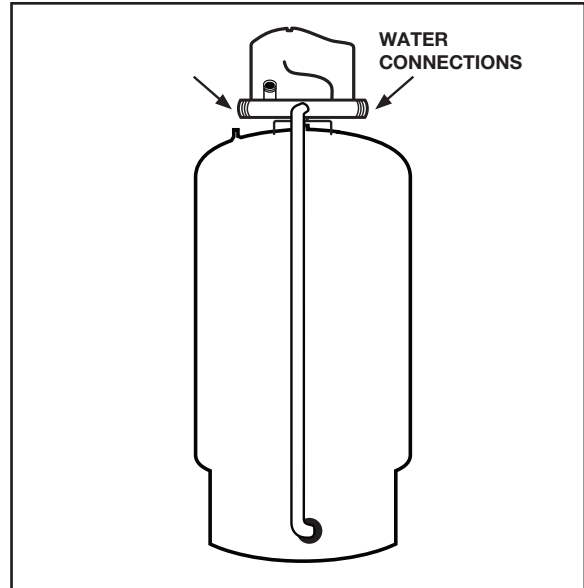

4. Connect the water line from the well pump to the inlet of the Well-X1™.

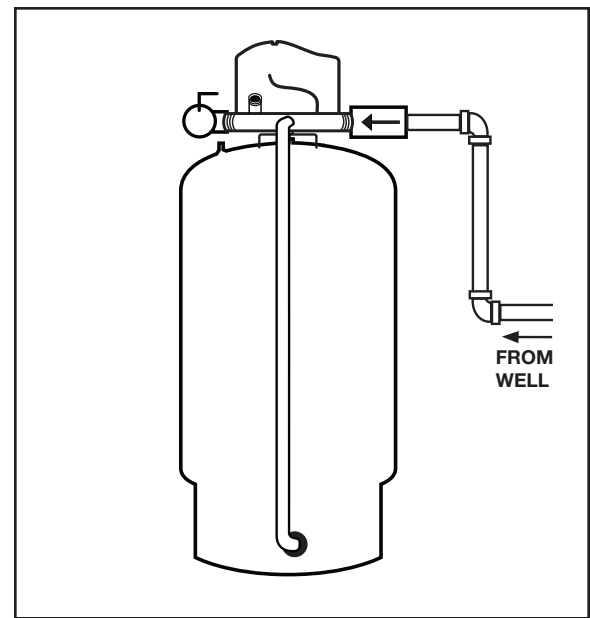

5. Plumb the outgoing supply to the building's water supply system or into the water treatment equipment (if present).

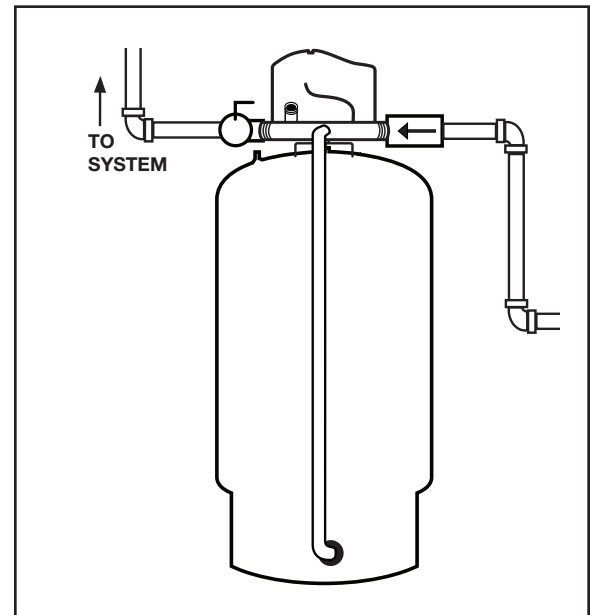

6. Install a blow down tube from the relief valve to a drain or to within 6" of the floor as required by local codes.

⚠ WARNING A drip pan connected to an adequate drain must be installed if leaking or flooding could cause property damage.

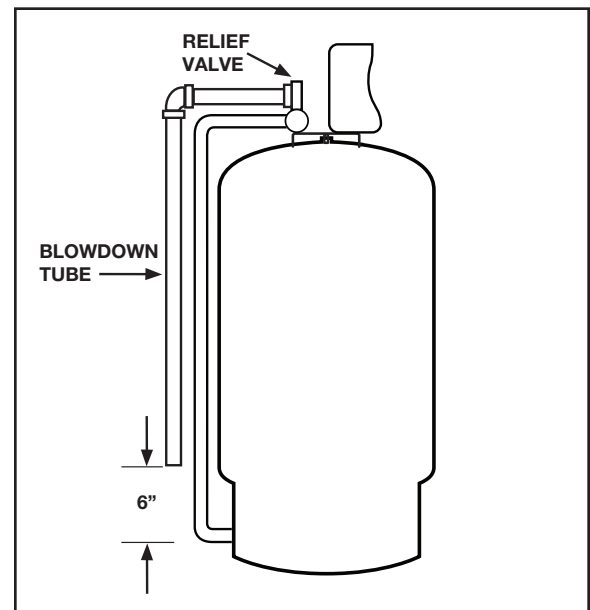

7. WIRING

1. Shut off the circuit breaker for the well system. Loosen the top screw housing cover. Flip the cover forward and remove to expose the control wires.

⚠ WARNING **Electrocution hazard.** For your safety, the information in this manual must be followed to minimize the risk of electric shock, property damage or personal injury. Properly ground to conform with all governing codes and ordinances.

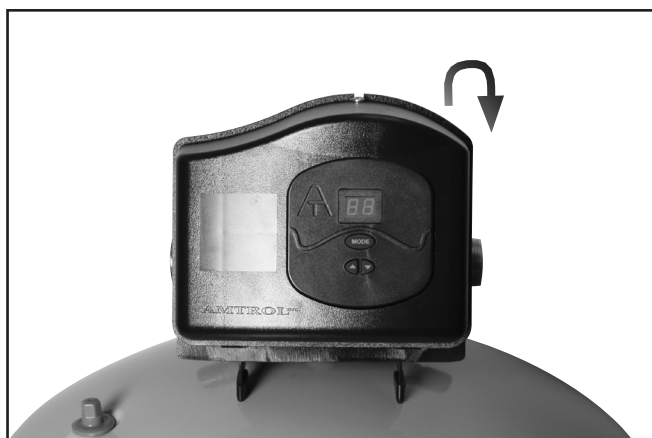

2. The 12 gauge wire leads are pre-stripped and ready to accept standard wire nuts. Each wire is color coded to correspond with the diagram below. Conduit knockouts are provided at the back of the control mounting plate. Attach the ground wire to the green ground screw provided. Use water tight conduit, connections, and wire nuts for an outside application.

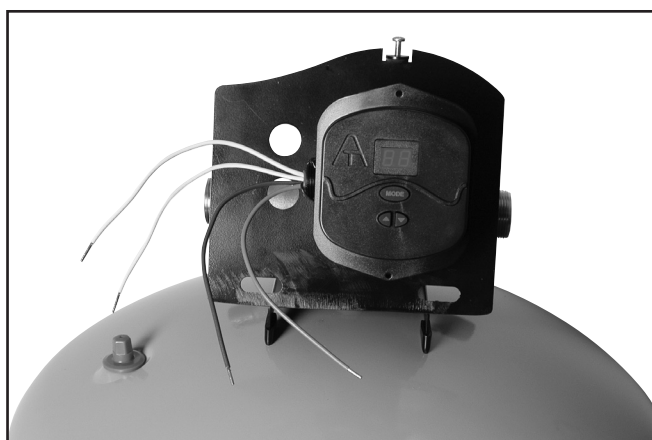

3. Wiring is similar to a traditional mechanical pressure switch. Two leads are connected to line supply, while the other supply the pump motor or starter. Wire the control to the line supply and pump motor or pump starter as required by the manufacturer's instructions. It is recommended that service switch be installed in addition to the circuit breaker. The disconnect for the controller must break all incoming power lines. This should interrupt line voltage and be installed near the Well-X1™ and labeled appropriately.

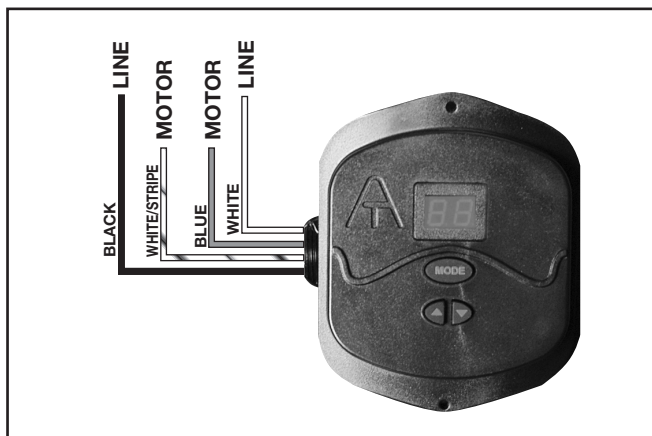

4. After completing the wiring, reattach the front cover by inserting the plastic tabs and snapping the cover into place. Tighten the top screw and ensure no loose wires protrude from the housing.

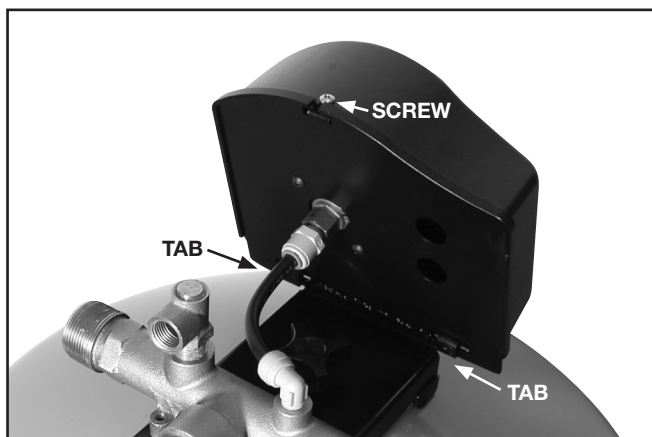

8. STARTUP & ADJUSTMENT

1. After plumbing and wiring are complete, close the service valve to allow startup without pressurizing the entire plumbing system. If a service valve was not installed, close all fixtures in the home. Ensure the bottom drain is closed.

2. Restore power to the Well-X1™ by turning on the breaker and electrical service switch (if installed). The display will illuminate.

3. The display will read "88" to test the display illumination, then a number identifying the control type (i.e. 07). This number is for factory use and may vary by model and manufacture date.

4. After a slight pause, the pump will start and the system pressure will be displayed. This number will increase as the pump runs and the tank fills.

Note: Some jet pumps may be difficult to prime, resulting in the low water cut-off activating if pressure will not build above 10 psig. Depressing the ▲ arrow will temporarily override the low water cut-off to allow proper priming.

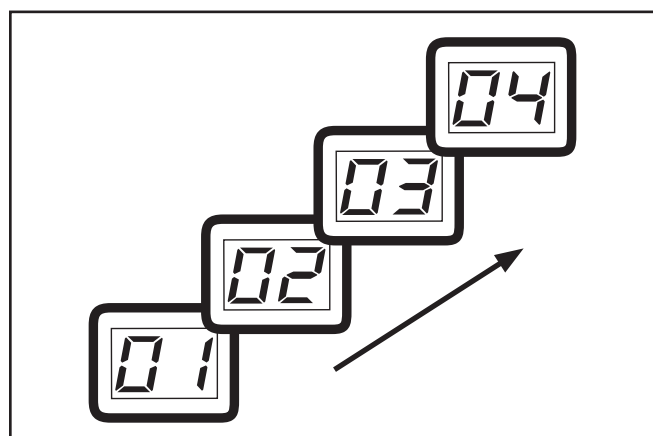
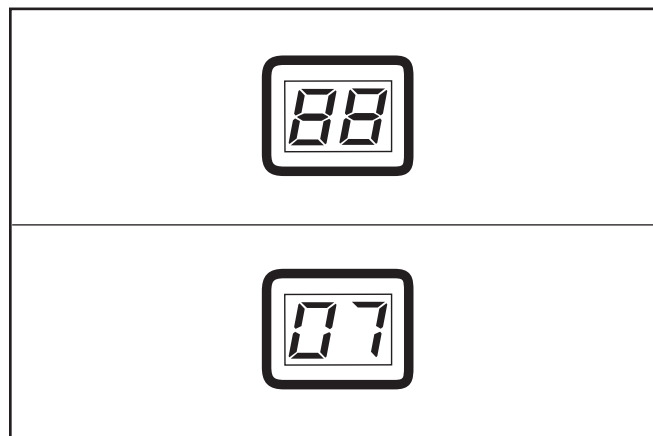
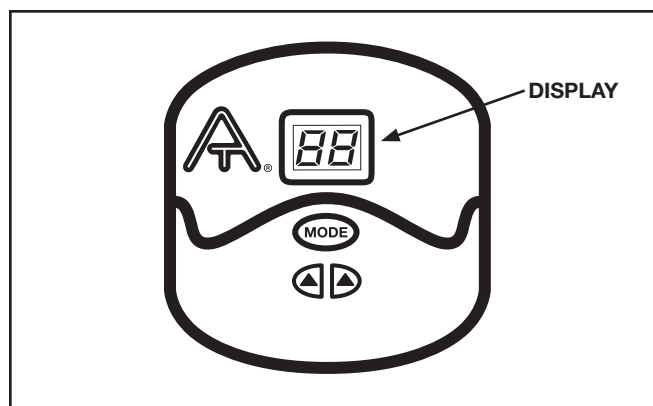
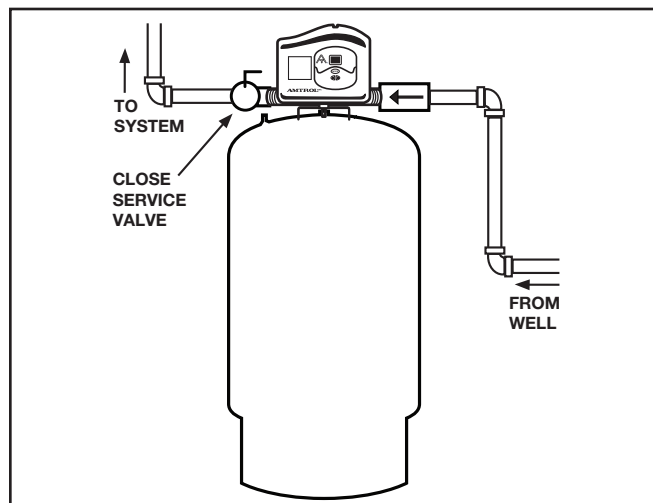

8. STARTUP & ADJUSTMENT (con't)

5. The factory cut-out (pump off) setting is 60 psig. When the pump reaches 60 psig, the Well-X1™ will shut the pump off. Check the plumbing for leaks and repair before continuing. If during startup the cut-out setting of 60 psig cannot be reached, read the adjustment instructions to lower the cut-out within the pump's capability.

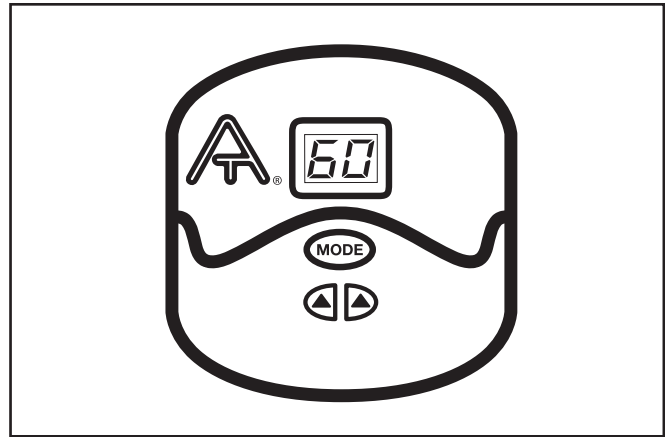

6. Slowly open the service valve to allow the system to pressurize. The pressure may drop slightly during this process. After the valve is fully open, open the fixture closest to the Well-X1™ to begin drawing water from the tank.

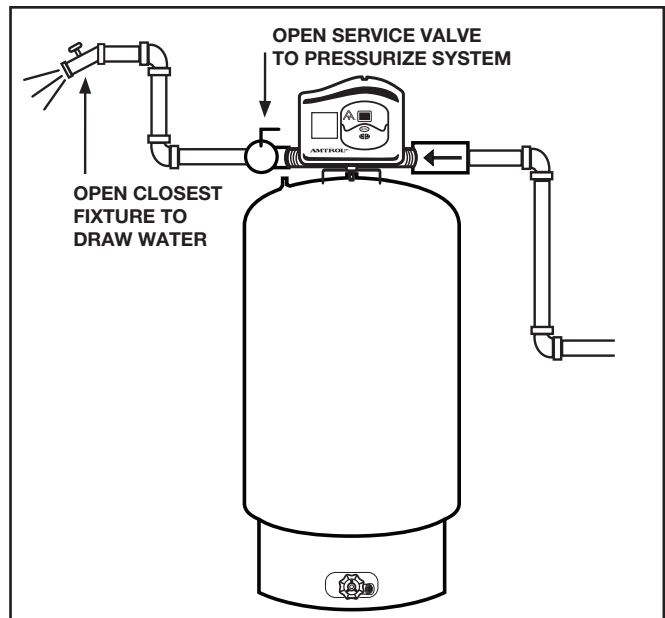

7. When the system reaches the factory cut-in (pump on) setting of 40 psig, the pump will start. Like a traditional mechanical switch, the pressure will begin to rise, repeating the cycle. If desired, the Well-X1™ settings can now be adjusted as shown below.

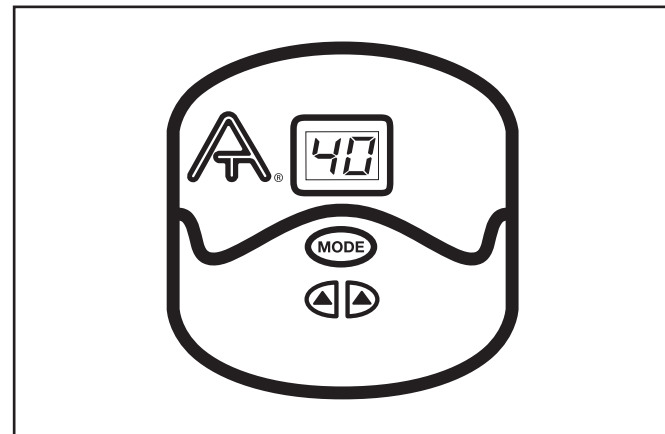

PRESSURE ADJUSTMENT

The Well-X1™ utilizes a simple cut-in/cut-out adjustment. Before setting the desired operating range, refer to the chart below to ensure the Well-X1's Maximum Acceptance is not exceeded. Adjust the precharge as shown on page 12.

CAUTION! Exceeding Maximum Acceptance will reduce tank life and cause irreparable damage.

Step 1: Find the Maximum Acceptance for the installed Well-X1™ model.

MODEL	MAXIMUM ACCEPTANCE
WX1-202	.57
WX1-203	.35
WX1-250	.77
WX1-251	.55
WX1-302	.54

Step 2: Ensure the desired operating range does not exceed that model's Maximum Acceptance.

		CUT-OUT PRESSURE												
		20	25	30	35	40	45	50	55	60	65	70	75	80
CUT-IN PRESSURE	10	.28	.38	.45	.50	.55	.59	.62	.65	.67	.69			
	15		.25	.34	.40	.46	.50	.54	.57	.60	.63	.65		
	20			.22	.30	.37	.42	.46	.50	.64	.57	.59	.61	
	25				.20	.27	.34	.39	.43	.47	.50	.53	.56	.58
	30					.18	.25	.31	.36	.40	.44	.47	.50	.53
	35						.17	.23	.29	.34	.38	.41	.45	.48
	40							.16	.22	.27	.31	.35	.39	.42
	45								.14	.20	.25	.30	.33	.37
	50									.13	.19	.24	.28	.32
	55										.13	.18	.22	.26
	60											.12	.17	.21
	65												.12	.16
	70													.11

1. To enter the programming mode, press and hold the **MODE** button until **LO** appears. This is the cut-in setting. Factory default will be 40 psi.

2. Use the ▲ and ▼ arrows to raise or lower the cut-in setting. Adjustment can be made within 10 psig or as wide as 55 psig of the cut-out setting to 60 psig. If this range is exceeded, the display will cease to change even though the button is being pressed.

Minimum setting is 10 psig.

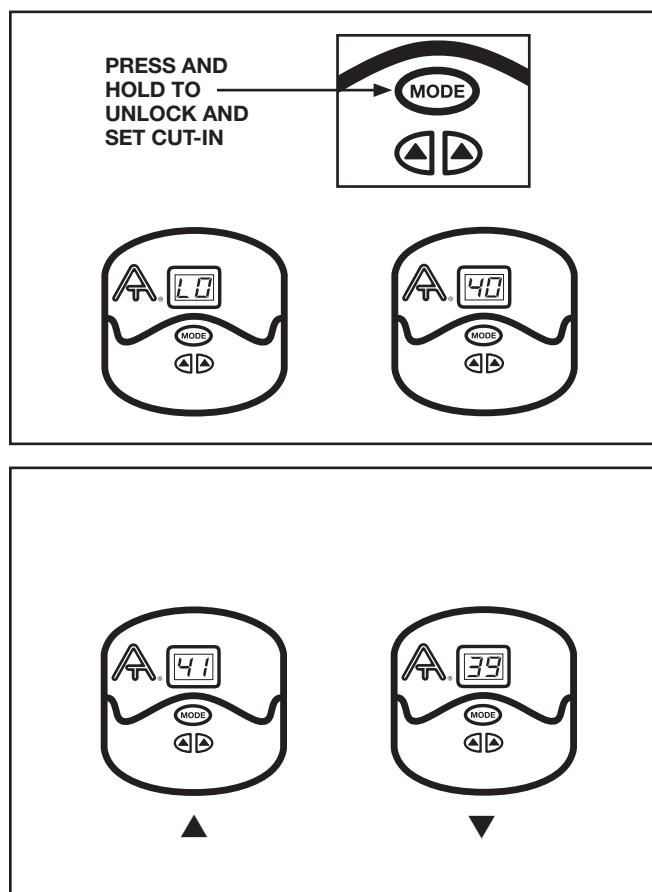

3. To adjust the cut-out, depress **MODE** once and the display will read **HI**. Again, press the ▼ or ▲ buttons to raise or lower the setting. The same 10-55 psig differential range applies.

Maximum setting is 80 psig.

4. After adjusting the cut-in and cut-out, release the buttons. After a slight pause, **Pr** will be displayed, indicating the settings are saved in the event of a power outage.

PRECHARGE ADJUSTMENT

Whenever the cut-in (LO) setting is changed, the tank precharge must be adjusted. To do this, shut the Well-X1™ off and open the drain to empty all water. Using an air gauge, adjust the precharge to 2 psig below the cut-in (LO) setting.

Failure to adjust the precharge will result in tank damage or water interruption.

⚠ WARNING DANGER! Explosion Hazard. If the Well-X1™ has been in service and a change to a higher pre-charge is necessary due to a required change in the setting, failure to follow instruction below can cause a rupture or explosion, possibly causing serious or fatal personal injury, and/or property damage.

- Do not adjust or add pressure if there has been a loss of air.
- Do not adjust the pre-charge pressure if there is visible exterior corrosion.
- Do not adjust the pre-charge pressure if there has been a reduction in pump cycle time or the pre-charge pressure compared to its initial setting. This is because reduction in pump cycle time can result from loss of tank air pressure which in turn can mean there may be internal corrosion and any re-pressurization or additional pressure could result in rupture or explosion.

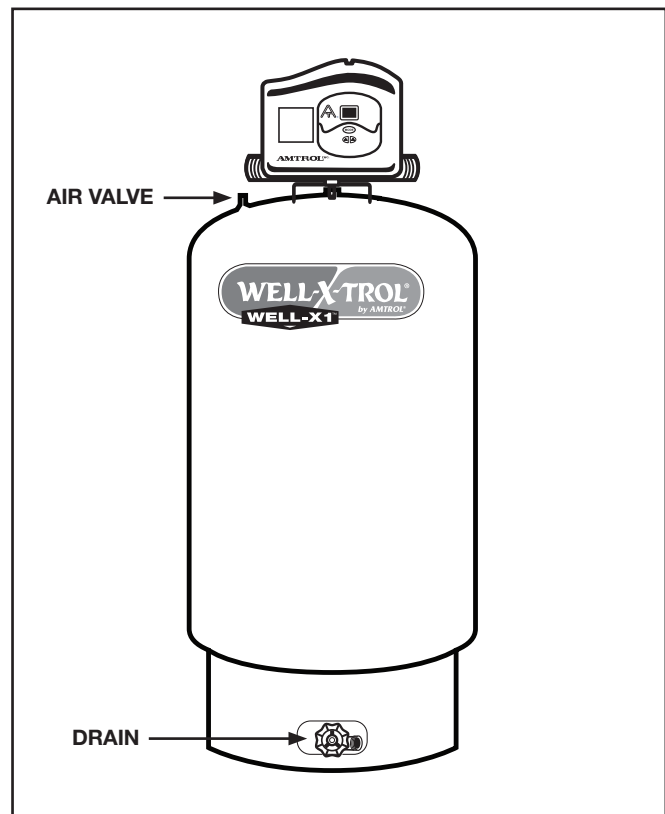
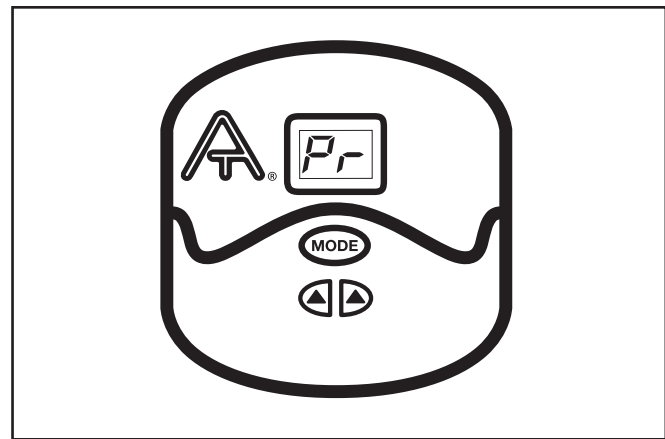
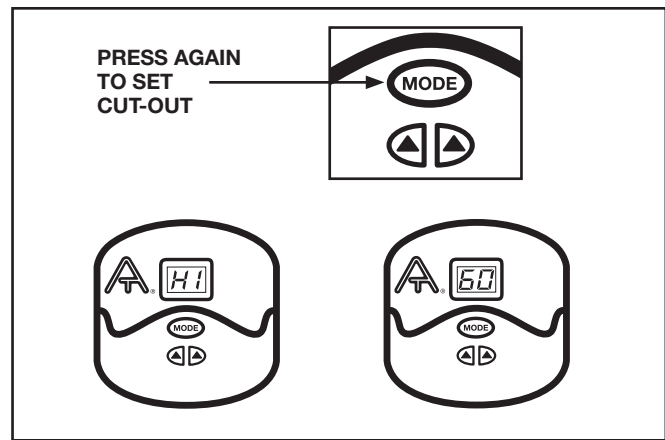





9. PUMP PROTECTION AND DIAGNOSTICS

The Well-X1™ continually monitors pressure, cycle time and voltage to protect the well pump. The following error codes alert the user to a potential problem, prompting service.

- E1: Rapid Cycle**
- E2: Low Suction (low water cut-off)**
- E3: Voltage Protection**
- E5: Improper Wiring**

WELL-X1™ ERROR CODES

When an error occurs, the display will flash a diagnostic code and emit an audible chirp.

ERROR CODE		POSSIBLE CAUSES AND CONTROL ACTION
	E1: Rapid Cycle	Multiple cycles below a safe runtime indicate an incorrect precharge, undersized Well-X1™ or waterlogged tank. Pump continues to run.
	E2: Low Suction	Pump operation below 10 psi indicates a low well level, well piping leak, insufficient prime, failing pump or loose wiring. Pump will shut down and attempt to restart every 60 minutes.
	E3: Voltage Protection	If line voltage varies outside a safe operating range, low or high, the control will run for up to two minutes to ensure water is available, then shut the pump off until voltage is restored to a normal range.
	E5: Improper Wiring	This error indicates the LINE and LOAD wiring is reversed at the Well-X1™. Correct wiring to allow proper operation.

NOTE: E4 is not used with the Well-X1™.

10. TROUBLESHOOTING

PROBLEM	POSSIBLE CAUSE	SOLUTION
Alarm sounds	1. Error encountered	1. See Error Code section for possible causes.
No water at fixtures	1. Error encountered 2. No power 3. Water line obstructed 4. Faulty pump 5. Drain or relief valve open 6. Leak in plumbing	1. See Error Code section for possible causes. 2. Check circuit breaker and wiring. 3. Ensure shut-off valves are open, check filtration equipment (if installed). 4. Repair or replace as necessary. 5. Ensure valves are closed. 6. Check piping.
Low water pressure	1. Pressure setting too low 2. Water line obstructed 3. Faulty pump 4. Pressure setting out of range 5. Incorrect wiring	1. Adjust pump cut-in and cut-out setting as described in manual. 2. Ensure shut-off valves are open, check filtration equipment (if installed). 3. Check well pump. 4. Reduce pressure settings within pump capacity. 5. Check pump wiring.
Intermittent water interruption	1. Tank precharge too high 2. Recurring error	1. Adjust air pressure 2 psi below cut-in setting. 2. See Error Code section for possible causes.
No pressure (pump runs)	1. No pump prime (jet pumps) 2. Failing well pump 3. Incorrect wiring	1. Prime pump and restart. 2. Repair or replace as necessary. 3. Check pump wiring.
Display will not illuminate	1. Circuit breaker or switch off 2. Faulty or loose wiring 3. Failed control	1. Check breaker and service switch. 2. Check line supply wiring. 3. Replace.
Pump will not turn on (Display illuminated)	1. Error encountered 2. Faulty pump 3. Failed control 4. Pressure sensor line blocked 5. Loose or faulty wiring	1. See Error Code section for possible causes. 2. Repair or replace as necessary. 3. Replace. 4. Remove and clean. 5. Check pump wiring.
Pump will not shut off	1. Pressure setting too high 2. Pump water line obstructed 3. Pump problem 4. Failed control	1. Decrease pressure settings until pump can reach cut-out. 2. Ensure no shut-offs are closed between pump and Well-X1™. 3. Inspect well pump condition and sizing if pump cannot reach a reasonable cut-out setting. 4. Replace.
Sediment or discoloration in water	1. Poor water quality	1. Install proper treatment equipment, drain and flush tank per instructions contained in this manual.
Rapid pump cycling	1. Differential too narrow 2. Improper precharge 3. Failed tank	1. Check sizing for intended operating range or spread differential to obtain proper pump run time. 2. Adjust air pressure 2 psi below cut-in setting. 3. Replace.
Relief valve discharges	1. Over-pressure condition 2. Faulty relief valve	1. See "Pump will not shut off" above. 2. If pressure is below 100 psi, relief valve should not open. Replace if faulty.

11. REPLACEMENT PARTS

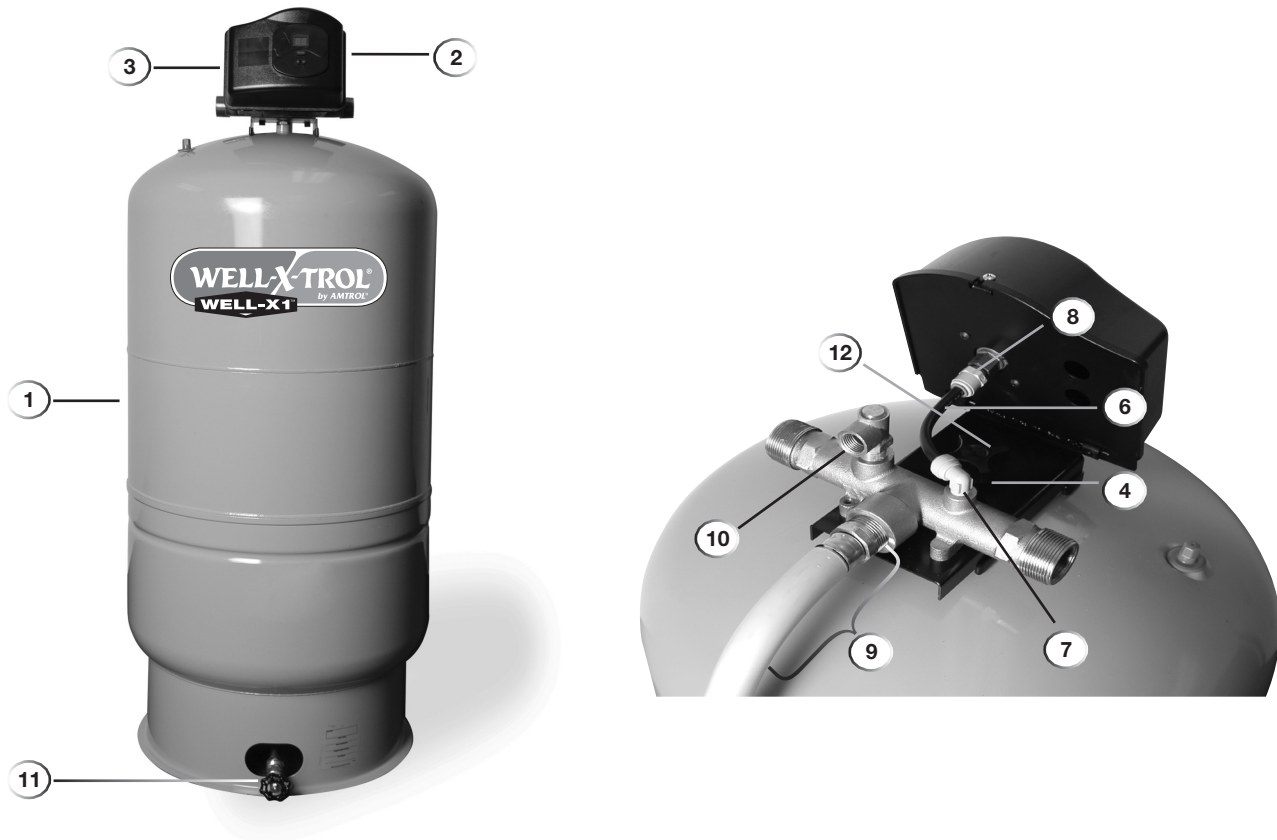

DESCRIPTION	POSITION	WX1-202	WX1-203	WX1-250	WX1-251	WX1-302
Replacement tank: Blue	1	144R273	146R825	145R379	145R380	150R92
Replacement tank: Tuf Kote™	1	144R274	146R826	145R381	145R382	150R93
Electronic control (no cover)	2	146R2321	146R2321	146R2321	146R2321	146R2321
Control cover	3	146R2333	146R2333	146R2333	146R2333	146R2333
Mounting bracket	4	146R2336	146R2336	146R2336	146R2336	146R2336
Brass tee only (no accessories)	5	140R517	140R517	140R517	140R517	140R517
Pressure sensor tubing	6	9403R197	9403R197	9403R197	9403R197	9403R197
Pressure sensor fitting (elbow)	7	9401R100	9401R100	9401R100	9401R100	9401R100
Pressure sensor fitting (straight)	8	9403R195	9403R195	9403R195	9403R195	9403R195
Tank tubing replacement kit w/fitting	9	9403R199-5	9403R199-4	9403R199-3	9403R199-2	9403R199-1
Relief valve, 100 psig	10	9403R191	9403R191	9403R191	9403R191	9403R191
Drain assembly	11	196R0003	196R0003	166R0013	166R0013	166R0014
Mounting knob	12	9403R194	9403R194	9403R194	9403R194	9403R194
Replacement carton	Not Shown	9196R0003	9196R0006	9166R013	9166R016	9166R019

AMTROL INC. LIMITED PRODUCT WARRANTY

Products covered: all Products manufactured by AMTROL Inc. ("AMTROL").

This warranty cannot be transferred – it is extended only to the original Purchaser or First User of the Product. By accepting and keeping this Product you agree to all of the warranty terms and limitations of liability described below.

IMPORTANT WARNING – READ CAREFULLY THE INSTALLATION, OPERATING AND MAINTENANCE INSTRUCTIONS MANUAL ("MANUAL") to avoid serious personal injury and/or property damage and to ensure safe use and proper care of this product.

Who Receives AMTROL's Product Warranty

All purchasers or first users of the new Product. The Warranty is non-transferable.

What is covered by this Warranty

AMTROL warrants to the purchaser or first user of the new Product that at the time of manufacture, the Product is free from defects in material and workmanship. Any warranty claim must be made within one (1) year unless another time period is set forth in the Manual, measured from the time the Product was purchased.

What AMTROL Will Do If You Have a Covered Warranty Claim

In the event of a breach of the foregoing warranty, AMTROL will at its option either make repairs to correct any defect in material or workmanship or supply and ship either new or used replacement parts or products. AMTROL will not accept any claims for labor or other costs.

What This Warranty Does Not Cover – Exclusions and Limitations

This Warranty does not cover any failure or problem unless it was caused by a defect in material or workmanship. In addition, this Warranty shall not apply:

- if the Product is not correctly installed, operated, repaired or maintained as described in the Manual provided with the Product;
- to any failure or malfunction resulting from abuse (including freezing); improper or negligent: handling, shipping (by anyone other than AMTROL), storage, use, operation, accident; or alteration, lightning, flood or any other environmental condition;
- to any failure or problem resulting from the use of the Product for any purpose other than those specified in the accompanying Manual or alteration of any part of the product;
- if the Product is used anywhere except the United States, its territories or possessions, or Canada;
- this Warranty does not cover labor costs, shipping charges, service charges, delivery expenses, administrative fees or any costs incurred in removing or reinstalling the Product;
- this Warranty does not cover any claims submitted to AMTROL or an AMTROL-authorized distributor or retailer more than 30 days after expiration of the applicable warranty time period described in this Warranty;
- this Warranty also does not cover repair or replacement costs not authorized in advance by AMTROL.

Additional Warranty Limitations

ALL IMPLIED WARRANTIES, INCLUDING THE IMPLIED WARRANTIES OF MERCHANTABILITY AND FITNESS FOR A PARTICULAR PURPOSE ARE SPECIFICALLY DISCLAIMED. Some states do not allow limitations on how long an implied Warranty lasts, so the above limitation may not apply to you.

Limitations of Remedies

THE REMEDIES CONTAINED IN THIS WARRANTY ARE THE PURCHASER'S OR FIRST USER'S EXCLUSIVE REMEDIES. IN NO CIRCUMSTANCES WILL AMTROL BE LIABLE FOR MORE THAN, AND PURCHASER-FIRST USER'S REMEDIES SHALL NOT EXCEED, THE PRICE PAID FOR THE PRODUCT. IN NO CASE SHALL AMTROL BE LIABLE FOR ANY SPECIAL, INDIRECT, INCIDENTAL OR CONSEQUENTIAL DAMAGES, WHETHER RESULTING FROM NONDELIVERY OR FROM THE USE, MISUSE, OR INABILITY TO USE THE PRODUCT OR FROM DEFECTS IN THE PRODUCT OR FROM AMTROL'S OWN NEGLIGENCE OR OTHER TORT. This exclusion applies regardless of whether such damages are sought for breach of warranty, breach of contract, negligence, strict liability, in tort or under any other legal theory. Such damages include, but are not limited to, inconvenience, loss or damage to property, mold, loss of profits, loss of savings or revenue, loss of use of the Products or any associated equipment, facilities, buildings or services, downtime, and the claims of third parties including customers. Some states do not allow the exclusion or the limitation of incidental or consequential damages, so the above limitation or exclusion may not apply to you.

What To Do If You Have a Problem Covered By This Warranty

Any covered Warranty service must be authorized by AMTROL. Contact the person from whom you purchased the Product, who must receive authorization from an AMTROL distributor or AMTROL. If you do not receive a prompt response, call AMTROL directly at 877-517-9673. Notice of a Warranty claim should be submitted by the authorized distributor to AMTROL at the following address:

AMTROL Inc.
Warranty Claim Dept.
1400 Division Rd.
West Warwick, RI 02893

Before AMTROL determines to provide any replacement part or Product, it may as a pre-condition to making such a determination require that the warranty claimant ship the Product, postage prepaid to an authorized AMTROL distributor, or to AMTROL and provide proof of purchase evidenced by the original sales receipt or Product registration.

Replacement Product Warranty

In case of replacement of a Product or any component part, AMTROL reserves the right to make changes in the design, construction, or material of the substitute components or products, which shall be subject to all of the terms and limitations of this Warranty, except that the applicable warranty periods shall be reduced by the amount of time the warranty claimant owned the product prior to submitting notification of the warranty claim.

Free Manuals Download Website

<http://myh66.com>

<http://usermanuals.us>

<http://www.somanuals.com>

<http://www.4manuals.cc>

<http://www.manual-lib.com>

<http://www.404manual.com>

<http://www.luxmanual.com>

<http://aubethermostatmanual.com>

Golf course search by state

<http://golfingnear.com>

Email search by domain

<http://emailbydomain.com>

Auto manuals search

<http://auto.somanuals.com>

TV manuals search

<http://tv.somanuals.com>