

ENGLISH



ARCHOS 405



ARCHOS 605 WIFI



ARCHOS 705 WIFI

GEN 5 ENGLISH USER MANUAL

Version 3.0

Please visit www.archos.com/manuals to download the latest version of this manual.

Dear Customer,

Thank you for choosing this ARCHOS product. We hope that you will enjoy using it and that it will give you satisfaction for many years to come.

Please do register your product on our website (www.archos.com/register) to ensure that you get access to our help line and to be informed of free software updates for your product.

Wishing you the best multimedia experience,

The ARCHOS Team.

All the information contained in this manual was correct at the time of publication. However, as we are often updating and improving our products, your device's software may have a slightly different appearance or modified functionality than presented in this manual.

Entertainment *your* way **ARCHOS**

TABLE OF CONTENTS

INTRODUCTION.....	4
ARCHOS DESCRIPTION	4
FIRST TIME USAGE: CHARGING THE BATTERY	6
TURNING THE ARCHOS ON/OFF	7
USING THE ARCHOS INTERFACE	7
CHANGING THE LANGUAGE	12
PRODUCT CARE	12
1. PLAYING VIDEO	13
1.1 BROWSING THROUGH YOUR VIDEOS	13
1.2 VIDEO PLAYBACK	14
1.3 VIDEO PLAYER SETTINGS.	17
1.4 PUTTING VIDEOS ONTO YOUR ARCHOS	18
1.5 RECORDING VIDEO	19
1.6 PLAYING YOUR PC'S SHARED VIDEOS	19
2. PLAYING MUSIC.....	20
2.1 BROWSING THROUGH YOUR MUSIC FILES.	20
2.2 MUSIC PLAYBACK	22
2.3 MUSIC PLAYER SETTINGS	24
2.4 PLAYLISTS	26
2.5 PUTTING MUSIC ONTO YOUR ARCHOS.	28
2.6 RECORDING ANALOGUE AUDIO	29
2.7 PLAYING YOUR PC'S SHARED MUSIC	30
3. VIEWING PHOTOS	31
3.1 BROWSING THROUGH YOUR PHOTOS.	31
3.2 PHOTO VIEWER.	32
3.3 PHOTO VIEWER SETTINGS	34
3.4 PLAYING A SLIDESHOW	35
3.5 VIEWING PHOTOS WHILE LISTENING TO MUSIC	35
3.6 PUTTING PHOTOS ONTO YOUR ARCHOS.	36
3.7 PLAYING YOUR PC'S SHARED PHOTOS	36
4. USING THE FILE BROWSER	37
4.1 NAVIGATION	37
4.2 USING THE VIRTUAL KEYBOARD	39
4.3 USING THE FILE BROWSER WHILE LISTENING TO MUSIC	40
4.4 BROWSING OTHER COMPUTERS ON THE NETWORK	41
4.5 USING THE PDF READER	41

TABLE OF CONTENTS CONTINUED ON NEXT PAGE...

5. CONNECTING TO A WIFI NETWORK	44
5.1 WIFI CONNECTION PROCEDURE	44
5.2 WIFI NETWORK CONFIGURATION	45
6. THE WIFI FEATURES	48
6.1 BROWSING THE WEB	48
6.2 PLAYING YOUR PC'S SHARED MEDIA FILES	50
6.3 THE ARCHOS CONTENT PORTAL.	53
7. TRANSFERRING FILES	54
7.1 CONNECTING THE ARCHOS TO A COMPUTER	54
7.2 USB HOST CONNECTION	56
8. MAIN SETTINGS	58
8.1 "SOUND" SETTINGS	58
8.2 "DISPLAY" SETTINGS.	60
8.3 "APPEARANCE" SETTINGS.	61
8.4 "LANGUAGE (AND REGION)" SETTINGS.	62
8.5 "TV CONTROL" SETTINGS	62
8.6 "CLOCK" SETTINGS	63
8.7 "POWER" SETTINGS.	64
8.8 "FIRMWARE AND PLUG-INS" SETTINGS	65
8.9 UPDATING THE FIRMWARE.	66
8.10 "SYSTEM" SETTINGS	67
9. OPTIONAL FUNCTIONALITIES	69
9.1 ARCHOS ACCESSORIES	69
9.2 ARCHOS PLUG-INS.	70
9.3 SCHEDULING A TV RECORDING	70
9.4 RECORDING EXTERNAL VIDEO MANUALLY	71
9.5 RECORDING EXTERNAL AUDIO MANUALLY	72
9.6 DISPLAYING THE ARCHOS ON A TV	72
TROUBLESHOOTING	73
RESETTING YOUR ARCHOS	73
SYSTEM RECOVERY	74
TOUCHSCREEN PROBLEMS	75
REPAIR AND FORMATTING TOOLS.	75
REPLACING THE BATTERY	76
TECHNICAL SPECIFICATIONS	77
TECHNICAL SUPPORT INFORMATION	81

INTRODUCTION



- The information presented in this manual might vary according to which ARCHOS Gen 5 model you have.
- Every time you see one of these icons, it means that the following section will concern this and only this model.

405

605

705

ARCHOS DESCRIPTION

MAIN BUTTONS



ARCHOS 605 WiFi

- Press and hold to turn your ARCHOS on/off.*
- The LED indicator, located next to the button, lights up when the device is on.

* When you keep the Power button held down, two messages will appear, one after the other. If you release the button during the first message, your device will keep using a small amount of battery power to allow a quick start up.

If you do not plan on using the ARCHOS for an extended period of time, keep the button held down until you see a second message appear. The device will shut down completely, and there will be absolutely no battery usage.

- TV/
LCD • Press once to switch the display of the image between the built-in LCD screen and a TV (with the optional DVR Station Gen 5, Mini Dock or Battery Dock, available at www.archos.com). See *Optional Functionalities*.
- When the image is displayed on a TV, the **TV/LCD** LED indicator lights up and the built-in LCD screen turns off.
- Press and hold to lock/unlock your device's buttons/touchscreen. This can be useful if your ARCHOS is in your pocket, for example, and you do not want to press a button or touch the screen by accident.

LED INDICATORS

CHG Battery charge indicator.

- light on: the battery is charging
- flashing: the battery is fully charged

HDD Hard Disk Drive activity indicator (*depending on model*):

- the light flickers when the hard drive is active (playing/transferring files)

TV/ Video display indicator:

- LCD • the light is on when the image of the ARCHOS is displayed on a TV (see **TV/ LCD** button).

CONNECTORS

ARCHOS 705

On the left side of the device:

- Power jack : charge the battery of your ARCHOS device (see *First Time usage: Charging the Battery*).
- AV Out Jack: connect headphones or plug an ARCHOS AV cable (optional) to view videos and photos on a television.

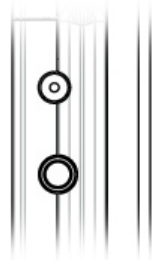

Underneath the device:

- USB **B**: connect your ARCHOS to a computer (see *Connecting the ARCHOS to a Computer*).
- USB **A**: connect a compatible external device to your ARCHOS (see *USB Host Connection*).

- *The Docking connectors allow you to plug the optional DVR Station Gen 5 (available from www.archos.com) in order to record external audio/video.*
- See **Optional Functionalities**.



ARCHOS 405 and 605

On the left side of the device:



- Headphone Jack: to connect headphones.

Underneath the device: These connectors allow you to:

- Connect your ARCHOS to a computer (see *Connecting the ARCHOS to a Computer*).
- Charge the battery of your ARCHOS (see *First Time usage: Charging the Battery*).

The Docking connectors also allow you to plug one of the optional accessories (available from www.archos.com):*



- *Connect a compatible USB device to the ARCHOS, with the optional DVR Station Gen 5, Mini dock or Battery Dock.*
- *Record external audio/video, with the optional DVR Station Gen 5 or DVR Travel Adapter.*
- See **Optional Functionalities**.

605 705 BUILT-IN LOUDSPEAKER



A single speaker (605 WiFi) or two speakers (705 WiFi) are located on the front of the device.

605 705 LEG STAND

- Your ARCHOS is equipped with a leg stand, located on the back of the device.
- Carefully pull it out, and it will allow your ARCHOS to stand by itself on a flat, stable surface.

MEMORY CARD SLOT

(depending on model)

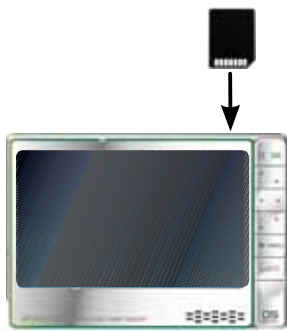

The memory card slot, located on top of the device, on the right side, allows you to insert one of the following cards (which are not supplied):

- SD
- MMC
- Mini and micro SD (with adapter)
- RS MMC (with adapter)

To learn how to browse the contents of your card, see: *Browsing Through your Videos*, *Browsing Through your Music Files*, *Browsing Through your Photos* or *Using the File Browser*.

Before removing your memory card from its slot, always select the menu item “Remove SD/MMC card safely”, available from the Home screen.

FIRST TIME USAGE: CHARGING THE BATTERY

405 605 USING THE USB CABLE

Before using your ARCHOS for the first time, completely charge its battery. The battery of your ARCHOS charges via your computer's USB port:

1. Plug the ARCHOS USB cable into your ARCHOS (which is off).
2. Plug the USB end of the cable into your computer (which is turned on).
3. The ARCHOS will turn on and start charging:
 - A lightning bolt symbol will flash over the battery icon in the task bar while the battery is charging: .

- The **CHG** indicator LED is on while the battery is charging. It will blink when the battery is fully charged.

You can also charge your ARCHOS device without a computer, and more rapidly, via the optional DVR Station Gen 5, Mini Dock or Battery Dock (available at www.archos.com). See Optional Functionalities.



705 USING THE CHARGER/ADAPTER

- Before using your ARCHOS device for the first time, charge the battery until the **CHG** light starts blinking.
- Simply plug the ARCHOS Charger/Adapter into the power jack. The ARCHOS device will turn on and start charging, and a lightning bolt symbol will flash over the battery icon in the status bar: .
- The ARCHOS has a removable battery. To learn how to replace it, see: *Troubleshooting*.

TURNING THE ARCHOS ON/OFF



ARCHOS 605 WiFi

- Press and hold the  button to turn your ARCHOS on/off. See *ARCHOS Description*.
- The LED indicator, next to the  button, lights up when the device is on.

USING THE ARCHOS INTERFACE

INTERFACE DESCRIPTION

Status Bar

- In the top right corner of the screen, the status bar indicates the volume, the battery level and the current time of your device.







Tabs

- In the top left corner of the screen, the tabs area shows other available applications and screens. They vary, depending on where you are in the interface.
- When there is only one tab available, the Tab icon  in the top left corner is grayed out.

Contextual Menu

- In the lower right corner of the screen, the contextual menu area shows the menu icons. The available options will vary, depending on where you are in the interface.
- In the Home screen, choose the "**Settings**"  menu item to access the main settings of your ARCHOS.
- In the Home screen, the "**Resume**" menu item  allows you to resume the last-played music or video file, if it was interrupted before the end. If the "**Resume**" menu icon  does not appear, it means that no music or video file playback can be resumed.



(depending on model)

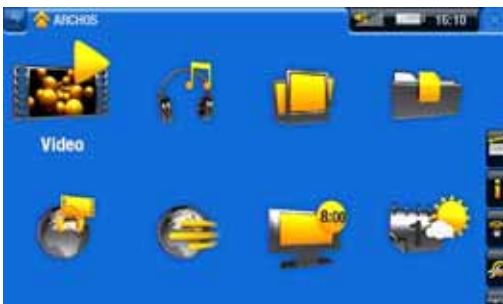

(depending on model)

Home Screen

- This is the main screen of your ARCHOS, showing its main functions.

605

705

USING THE TOUCHSCREEN







Your ARCHOS is equipped with a touchscreen. Below is a description of the main tactile screen areas and a few tips on how to use the touchscreen.

In order to avoid damaging the screen surface, you should use only the included stylus or your fingernail.

Main Touchscreen Actions

- To open an application/screen via its icon or item, tap on the icon/item to highlight it, and tap on it again.

- In the different applications, you can go back one level in the hierarchy by tapping on the Exit icon  (in the top right corner of the screen). Wherever you are in the hierarchy, you can go back directly to the Home screen by holding down on the Exit icon.
- When several tabs are available, you can switch between them by tapping on the Tab icon  (in the top left corner of the screen). You can also tap directly on one of the tabs to access the corresponding screen.
- To execute a menu item's function, simply tap on its icon. In order to display a text description of the icon, tap on the **menu** word.
- While playing a video or song, you can pause/resume it by tapping on the Pause  / Play  icon.

Other Touchscreen Actions



- When watching a video or listening to music, you can tap on the progression bar to go directly to a different location in the video or song. You can also use the stylus to drag the cursor in the progression bar to another location in the video or song.
- In the screens where it appears, the volume bar can be dragged in the same way.
- In the different browsers (File, Music, Video, Photo), you can drag the scroll bar up and down to scroll the file list up and down. You can also scroll faster by tapping above or below the cursor in the scroll bar.
- In the Web browser and the PDF viewer, you can scroll up and down by tapping on the page and dragging it up or down (be careful however not to tap on a link!).









405

605



USING THE BUTTONS

The navigation buttons are located on the right side of the device:



-  Exit button (*Escape / Back / Stop*)
-  OK button (*Enter/Accept or Play/Pause/Resume*)
-  Up Accelerator button (*high-speed fast forward, list scrolling or zoom in*)
-  Navigation buttons (*move from an item to another*)
-  Down Accelerator button (*high-speed fast rewind, list scrolling or zoom out*)
-  Tab button (*tab between available screens*)
-  Menu button (*display a text description of the available menu icons*)
-  Volume button (*increase/decrease volume*)

Main Button Actions:

- To open an application/screen via its icon or item, use the Navigation buttons to highlight the icon/item and press **OK**.
- In the different applications, you can go back one level in the hierarchy by pressing the Exit button  once. Wherever you are in the hierarchy, you can go back directly to the Home screen by holding the Exit button.
- When several tabs are available, you can switch between them by pressing the Tab button .
- To execute a menu icon's function, press the **menu** button, select a menu item with the navigation pad, and press **OK**.
- While playing a video, song or photo slideshow, you can pause/resume it by pressing **OK**.

Other Button Actions



- When watching a video or listening to music, you can hold the left/right Navigation buttons to move the cursor in the progression bar to another location in the video or song.
- To increase/decrease volume, use the Volume button .
- In the different browsers (File, Music, Video, Photo), you can hold the up/down Navigation buttons to scroll the file list up and down. You can also scroll faster by using the Accelerator buttons.
- In the Web browser (*depending on model*) and the PDF viewer, you can scroll up and down by holding the up/down Navigation buttons.



705







USING THE REMOTE CONTROL





- If you are displaying the image of the ARCHOS on a TV, you will need the remote control in order to control your ARCHOS device.
- Your ARCHOS device has an infrared receiver located on the front of the device, in the bottom left corner. Point the supplied remote control towards the infrared receiver.



1	<i>This part of the remote control is used for the Web Browser and the Widgets.</i>	
		Use the direction pad to move the cursor that appears on the screen.
		<p>Pressing this button will activate 2 modes at the same time:</p> <ul style="list-style-type: none"> - the "left button lock" mode: the direction pad will act as if you moved a mouse while holding its left button at the same time. It will allow you, for example, to use sliders or other dragging controls. - the navigation buttons, at the top right, will allow you to move from one link/field to another (normally they scroll the page up/down). <p>Press again to disable these 2 modes.</p>
	L	This button is like a mouse's left button. Depending on where you are in the interface, it will allow you to open a link, execute a function, etc (same as if you tapped on the screen).
	R	This button is like a mouse's right button. Depending on where you are in the interface, pressing this button will display a contextual menu (same as if you held down on the touchscreen).

2	<i>These are the main buttons:</i>	
		Navigation buttons: move from one item to another
	OK	Enter/Accept or Play/Pause/Resume
	X	Escape/Back/Stop
		High-speed fast forward, list scrolling or zoom in
		High-speed fast rewind, list scrolling or zoom out
	M	Display a text description of the available menu icons
	TV	Switch the display of the image between the built-in LCD screen and a TV
		Turn on the ARCHOS / put it into standby mode
	+ -	Increase/decrease volume
		Mute sound
		Tab between available screens

3 The keyboard can be used, for example, to enter a Web address, write an e-mail, name/rename a folder, etc:

	Caps Lock key
Alt	Green Alt key: enable the keys' green secondary functions
Alt	Blue Alt key: enable the keys' blue secondary functions
	Shift key
	delete character before cursor



In order to type one of the green/blue secondary characters in capital letters (é, è, ç, etc.), press Caps Lock, then Alt green/blue, and press the corresponding key.

CHANGING THE LANGUAGE



- The interface of your ARCHOS is available in various languages.
- If your language is not available, go to the ARCHOS website (www.archos.com/firmware) and download and install the latest version of the firmware. New languages are included in the firmware as they become available. See *Updating the Firmware*.

To change the system's language:

1. In the Home screen, select the "**Settings**"  menu item, and choose "**Language (and Region)**".
2. Select a different language using the left/right arrows (your settings are saved instantly).
3. Close the screen  to exit and go back to the Home screen.

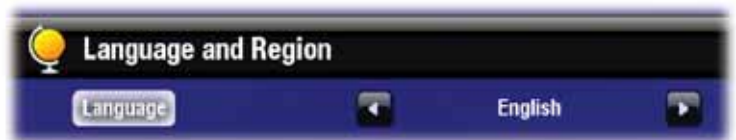

PRODUCT CARE

Your ARCHOS is an electronic product that needs to be treated with care:

- Do not subject it to unnecessary shock or vibration.
- Do not subject it to heat, keep it ventilated (especially when connected to a computer).
- Keep it away from water and excessively humid areas.
- Keep it away from high electromagnetic fields.
- Do not open it up. There are no user-serviceable parts inside. Opening will void your warranty.

1. PLAYING VIDEO



In the Home screen, select the “**Video**” icon to enter the Video mode.

1.1 BROWSING THROUGH YOUR VIDEOS

- The “**Video**” browser allows you to navigate through the **Video** folder of the ARCHOS’ hard drive.
- You can go back one level in the hierarchy by closing the current screen . Wherever you are in the hierarchy, you can go back directly to the Home screen by pressing and holding down on the Exit icon/button.

THE VIDEOBROWSER

- The first screen of the Video mode shows you all the videos and subfolders located in the **Video** folder.
- To play a video, highlight it, then open it.
- If a video is in a subfolder of the **Video** folder, open the subfolder, and you will see your video.



- *In the “Video” browser, each video file appears with a thumbnail, displayed on the left of the file’s name.*
- *To define a new thumbnail for a video file, open the video, select the “Set” menu item, and choose “Thumbnail” (see: Video Playback Menu Items).*

BROWSING THROUGH YOUR MEMORY CARD’S VIDEOS

(Depending on model)

- If you have inserted a memory card into the ARCHOS (see: *Memory Card Slot* to learn how to insert/remove a memory card), select the line “**SD/MMC card**”, in the first screen of the “**Video**” Browser.
- You can now browse the contents of your card and play your videos (if your card contains any). In the Video browser, only video files and folders will appear.

VIDEO BROWSER MENU ITEMS

"Info"

 - displays a message box with information about the highlighted video file.

"File Management"

 - **"Rename"**: allows you to change the name of the highlighted video file using the virtual keyboard. See: *Using the Virtual Keyboard*.
- **"Delete"**: allows you to delete the highlighted video file. A confirmation screen will pop up.

"Bookmark"

 - **"Resume"**: will resume playing the highlighted video from the bookmark.
- **"Clear"**: will remove the bookmark from the highlighted video file.

"Bookmark" only appears in the menu when a bookmarked video file is highlighted.

"Settings"

 - you can choose to display the Video Player settings screen (see: *Video Player Settings*) or the **"Sound"** settings screen (see: *"Sound" Settings*).

1.2 VIDEO PLAYBACK

To play a video, highlight the file and open it. The menu overlay will disappear automatically after a few seconds.

VIDEO PLAYBACK SCREEN





1. Exit icon
2. video file name
3. Tab icon
4. volume level
5. play / pause icon
6. video progression bar
7. menu items



605

705

VIDEO PLAYBACK TOUCHSCREEN CONTROLS

- To pause/resume the video, tap on the Pause  / Play  icon (see n° 5 in the previous screen).
- To display the menu overlay again, tap once anywhere on the screen. To make it disappear again, wait for a few seconds or tap on the Tab icon  in the top left corner (see n° 3).
- You can tap on the progression bar to go directly to a different location in the video. You can also use the stylus to drag the cursor in the progression bar to another location in the video (see n° 6).
- The volume bar can be dragged in the same way (see n° 4).
- To execute a menu item's function, simply tap on its icon. In order to display a text description of the icon, tap on the **menu** word (see n° 7).
- To stop the video and go back to the "**Video**" browser, tap on the Exit icon  (see n° 1). To exit the Video mode and go back directly to the Home screen, hold down on the Exit icon.

405

605

VIDEO PLAYBACK BUTTON CONTROLS

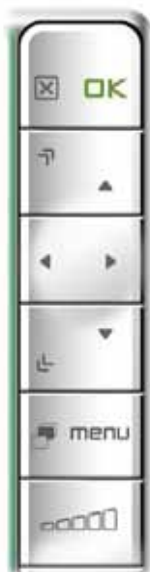

- press once: stop the video and go back to the "**Video**" browser
- hold: exit the Video mode and go back directly to the Home screen.



pause/resume the video



accelerated fast forward



left/right: fast rewind/forward



accelerated fast rewind



display/hide the menu overlay



display available menu items





increase/decrease volume

VIDEO PLAYBACK MENU ITEMS

"Info"

- displays a message box with information about the current video file.

"Soundtrack" and/or "Subtitles"

-  - allows you to select a different audio track*.
-  - allows you to choose subtitles**.

* Only if the video file contains several audio tracks.

** Only if the subtitles are in a separate file. The supported file types are: .srt, .ssa, .sub (text based) and .smi.



"Format"

-  - allows you to change the way the image is displayed.
- "**Auto**": adjusts the video size to best adapt to the built-in screen (or TV, with the optional DVR Station Gen 5, Mini Dock or Battery Dock: see *Optional Functionalities*).
- "**Full Screen**": enlarges the picture to fill the screen. In order to fit the ARCHOS' screen, your device might need to cut small parts of the image, most likely at the top and bottom.
- "**Maximized**": enlarges the picture to fill the screen, considering the image is encoded in 2.35 format with black bands at the top and bottom.
- "**Original**": displays the entire picture in its original format.

"Speed"

-  - will play the current video in slow motion or high speed.
- while paused in slow motion, you can advance frame by frame, using the right arrow.

"Set"

-  - "**Bookmark**": sets a bookmark at the current spot in the video. Only one bookmark per file is allowed. You can bookmark up to 32 files. Bookmarked videos will appear, in the "**Video**" browser, with a bookmark symbol  and a progression bar.
- to resume playing a video from a bookmark, go to the "**Video**" browser and highlight the bookmarked video file. Select the "**Bookmark**" menu item, then choose "**Resume**" ("**Clear**" will remove the bookmark from the video).
- "**Thumbnail**": saves the current image as a new thumbnail for this file. In the "**Video**" browser, the video's thumbnail will be replaced by the new one.
- "**Wallpaper**": the current image will be defined as your device's background image.

"Settings"

-  - you can choose to display the Video Player settings screen (see: *Video Player Settings*) or the "**Sound**" settings screen (see: "*Sound*" Settings).

1.3 VIDEO PLAYER SETTINGS

- In the Video mode, you can access the Video Player settings screen by using the **"Settings"** menu item .
- Use the left/right arrows to select a different setting for a parameter.

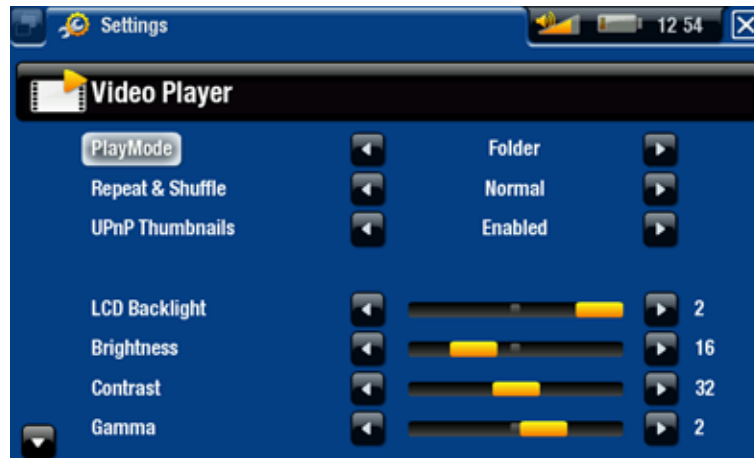

"PlayMode", "Repeat & Shuffle"

- the following table explains how the video player will work according to the settings you chose in **"PlayMode"** AND **"Repeat & Shuffle"**.

"PlayMode"	"Repeat & Shuffle"	What the video player does...
"Single"	"Normal"	- plays the current video file and stops.
	"Repeat"	- plays the current video file repeatedly.
"Folder"	"Normal"	- plays all the video files of the current folder one after the other, and then stops.
	"Repeat"	- plays all the video files of the current folder one after the other. This will be repeated indefinitely.
	"Shuffle"	- plays all the videos of the current folder randomly.

"UPnP Thumbnails"

- here you can enable/disable the video thumbnails while browsing through your PC's shared videos (see: *Playing your PC's Shared Media Files*). If you choose **"Disabled"**, you will be able to browse through your PC's shared videos faster.

"LCD Backlight", "Brightness", "Contrast" and "Gamma"

- adjusts the level of backlight/contrast/brightness/gamma of the built-in screen.
- you can also reset the LCD parameters to the default values ("**Reset**" button).

1.4 PUTTING VIDEOS ONTO YOUR ARCHOS

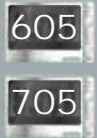

On the ARCHOS Content Portal, you have the possibility to purchase videos directly from your ARCHOS, without using a computer. See: The ARCHOS Content Portal.

There are two main methods to transfer the videos stored on your computer onto the ARCHOS:

1. Windows Media® Player: copy your videos using Windows Media® Player 10 or higher*:



- Use Windows Media® Player 10 or higher* (**Sync** tab) to synchronize your computer's video files with the ARCHOS.
- See *Putting Files onto the ARCHOS* to learn more about how to transfer your computer's video files with Windows Media® Player.

** For best performance, we recommend that users update to Windows Media® Player 11 or higher.*

2. Windows® Explorer: Copy and paste your video files from your computer into the **Video** folder of your ARCHOS.

To learn how to connect/disconnect the ARCHOS from your computer, see the *Transferring Files* section.

CREATING COMPATIBLE VIDEO FILES WITH YOUR COMPUTER

If some of your videos don't play on your ARCHOS, you may need to convert them to a compatible format:

- The easiest way to do this is by using Windows Media® Player 10 or higher to transfer videos to your ARCHOS. Windows Media® Player will automatically convert most formats to the WMV format that your device can play. *See your Windows Media® Player help instructions for more information.*
- If you don't want to use Windows Media® Player, a search on the Internet should allow you to find suitable utility programs to do this job.

- If you would like to simply copy and paste unprotected DVD video files from your PC onto your ARCHOS without converting them to WMV format, you can purchase the Cinema plug-in from the ARCHOS website (www.archos.com). The same is also true for video podcasts in the H.264 format. In this case, purchase the Video Podcast plug-in.

1.5 RECORDING VIDEO



- With the optional DVR Station Gen 5, DVR Travel Adapter, or Helmet CamCorder (available at www.archos.com), your ARCHOS will be able to record video from most any standard video source.
- See: *Optional Functionalities*.



- With the optional DVR Station Gen 5, you will also have the possibility to schedule TV recordings easily, via the TV Program Guide (EPG).
- See the manual of your DVR Station Gen 5 to learn more about this feature.



DVR TRAVEL ADAPTER



DVR STATION GEN 5

605

705

1.6 PLAYING YOUR PC'S SHARED VIDEOS



- When connected to your home WiFi network, your ARCHOS gives you the possibility to watch, directly on your device, shared videos stored in your PC's Windows Media® Library.
- For this to work, you will need a WiFi connection and Windows Media® Player 11 or higher* installed on your PC.
- The ARCHOS uses the UPnP (Universal Plug-and-play) standard to stream shared videos from your PC's Windows Media® Library.
- See: *Playing your PC's Shared Media Files*.

** There are other products on the market that also can share media files using the UPnP standard.*

2. PLAYING MUSIC



In the Home screen, select the “**Music**” icon to enter the Music mode.

2.1 BROWSING THROUGH YOUR MUSIC FILES

- There are two types of views for you to browse through your songs: the Music Library and the Music Browser.
- In both views, you can go back one level in the hierarchy by closing the current screen . Wherever you are in the hierarchy, you can go back directly to the Home screen by pressing and holding down on the Exit icon/button.

THE MUSIC LIBRARY

- The Music Library (default view) shows your music sorted by categories (Artist, Album, Genre, etc.) if your music files contain these song information tags.
- When new music is copied to the ARCHOS, the Music Library will be updated automatically.
- If some of your music files do not contain information tags, they will be classified as (**Unknown**) in the Music Library.



THE MUSIC BROWSER

- The music browser allows you to navigate through the **Music** folder of your device's hard drive.
- To use it, select “**Hard Drive**” (or “**Internal Memory**”) in the initial Music Library view.



BROWSING THROUGH YOUR MEMORY CARD'S SONGS

(Depending on model)

- If you have inserted a memory card into the ARCHOS (see: *Memory Card Slot* to learn how to insert/remove a memory card), select the line "**SD/MMC card**", in the initial Music Library view.
- You can now browse the contents of your card and play your songs (if your card contains any). In Music mode, only music files, playlists and folders will appear.

When you insert a memory card, its contents (songs and playlists) are automatically integrated into the Music library.

MUSIC LIBRARY AND MUSIC BROWSER MENU ITEMS*

"Info"

 - displays a message box with information about the highlighted music file.

"Show playlist"

 - opens a playlist edition window on the right (see: *Playlists*).

"Bookmark"

 - "**Resume**": will resume playing the highlighted song from the bookmark.
- "**Clear**": will remove the bookmark from the highlighted music file.

"Bookmark" only appears in the menu when a bookmarked music file is highlighted.

"File Management"

 - "**Rename**": allows you to change the name of the highlighted music file using the virtual keyboard. See: *Using the Virtual Keyboard*.
- "**Delete**": allows you to delete the highlighted music file. A confirmation screen will pop up.

"Settings"

 - you can choose to display the Music Player settings screen (see: *Music Player Settings*) or the "**Sound**" settings screen (see: *"Sound" Settings*).

** The available menu items will vary depending on the mode you chose (Music Library or Music Browser).*

2.2 MUSIC PLAYBACK

- Use the scroll bar to browse through the list of audio tracks.
- To play a song, highlight the corresponding file and open it.

MUSIC PLAYBACK SCREEN





1. Exit icon
2. artist name, album title, song title, playback status icon(s) and track number
3. available tabs
4. volume level
5. play / pause icon
6. previous track
7. next track
8. progression bar
9. menu items



605

705

MUSIC PLAYBACK TOUCHSCREEN CONTROLS

- To pause/resume the song, tap on the Pause  / Play  icon (see n° 5 above).
- To play the previous/next song, tap in the corresponding area (n° 6 or 7).
- To browse through your songs while listening to music, simply tap on the Tab icon . This will take you to the Music Library or browser screen that you launched the current song from (see n° 3).
- You can tap on the progression bar to go directly to a different location in the song. You can also drag the cursor in the progression bar to another location in the song (see n° 8).
- The volume bar can be dragged in the same way (see n° 4).
- To execute a menu item's function, simply tap on its icon. In order to display a text description of the icon, tap on the **menu** word (see n° 9).
- To stop the song and go back to the Music Library or browser, tap on the Exit icon  (see n° 1). To exit the Music mode and go back directly to the Home screen, hold down on the Exit icon.

405

605

MUSIC PLAYBACK BUTTON CONTROLS

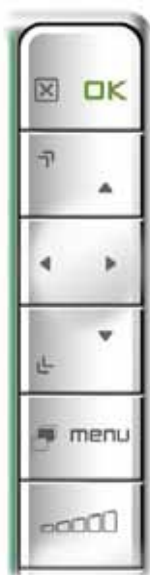

- press once: stop the song and go back to the "**Music**" Library or browser
- hold: exit the Music mode and go back directly to the Home screen.



pause/resume the song



accelerated fast forward



left:

- press once: back to the beginning of the song, or previous song (in the first 10 seconds of a track)
- hold: fast rewind

right:

- press once: next song
- hold: fast forward



accelerated fast rewind



tabs back to the Music Library or Music browser (depending on which mode you launched the song from)



display available menu items



increase/decrease volume

MUSIC PLAYBACK MENU ITEMS

"Info"

- displays a message box with information about the current music file.

"ARCHOS home screen"

- allows you to go back to the Home screen, and browse your hard drive or view your photos while listening to music.

"Set bookmark"

- sets a bookmark at the current spot in the song. Only one bookmark per file is allowed. You can bookmark up to 32 files.

- to resume playing a song from a bookmark, go to the Music Library or the Music Browser, highlight the bookmarked music file. Select the "**Bookmark**" menu item, then choose "**Resume**" ("**Clear**" will remove the bookmark from the song).

"Set rating"

 - allows you to give a rating to the current song (1-5) or to remove the rating (none).

"Settings"

 - you can choose to display the Music Player settings screen (see next section) or the "**Sound**" settings screen (see: "*Sound*" Settings).

2.3 MUSIC PLAYER SETTINGS

- In the Music mode, you can access the Music Player settings screen by using the "**Settings**" menu item .
- Use the left/right arrows to select a different setting for a parameter.

"PlayMode", "Repeat & Shuffle"

- the following table explains how the audio player will work according to the settings you chose in "**PlayMode**" AND "**Repeat & Shuffle**".
- An icon shows the current modes in the Music playback screen.











"PlayMode"	"Repeat & Shuffle"	What the video player does...
"Single" 	"Normal"	- plays the current song and stop.
	"Repeat" 	- plays the current song repeatedly.

Table continued on next page...

"PlayMode"	"Repeat & Shuffle"	What the video player does...
"Folder" 	"Normal"	- plays all the songs of the current folder one after the other, and then stops.
	"Repeat" 	- plays all the songs of the current folder one after the other. This will be repeated indefinitely.
	"Shuffle" 	- plays the songs of the current folder randomly.
"All" 	"Normal"	- plays all the songs of your ARCHOS one after the other, and then stops.
	"Repeat" 	- plays all the songs of your ARCHOS one after the other. This will be repeated indefinitely.
	"Shuffle" 	- plays all the songs of your ARCHOS randomly.
"Queue"  		<ul style="list-style-type: none"> - allows you to select a track to be played after the current one is finished. - while a track is playing, switch to the browser window, select a track to highlight it, then open it. This is your queued track, which will be played after the current track. - you can only queue one track at a time, and you need to select the song to queue before the end of the current track.
"Intro" 		- plays the first few seconds of each track. You can define the length to play in " Intro duration ". Only with 405 and 605: press OK during the intro period to let the whole song play.

"Intro duration"

- defines for how long each track will be played when "**PlayMode**" is set to "**Intro**".

2.4 PLAYLISTS



- A playlist is a list of audio tracks that the music player will automatically play one after the other.
- On your ARCHOS, you can play, create and edit as many playlists as you want.
- In the ARCHOS Browser, playlists are the files with the  icon.

Note: when you delete a playlist, you are only deleting the list and not the music itself.

PLAYING A PLAYLIST



- In the Music Library, highlight the **"Playlist"** line and open it.
- Highlight a playlist and open it. A panel showing the contents of the playlist will open on the right.
- Open the first item in the playlist to start playing from the first track.





PLAYLIST MENU ITEMS

These menu items appear when a music file is highlighted on the left panel:

"Add to playlist"



-  - **"Selected file"**: will add the highlighted track at the end of the current playlist.
-  - **"All files"**: will add all the tracks (from the left panel) at the end of the current playlist.

"Insert in playlist"



-  - **"Selected file"**: will insert the highlighted track before the selected item in the current playlist.
-  - **"All files"**: will add all the tracks (from the left panel) before the selected item the current playlist.

These menu items appear when the focus is on the right panel (playlist editor):



"Track"

-  - **"Remove track"**: deletes the highlighted track from the playlist.
-  - **"Move"**: allows you to change the position of the highlighted track within the playlist. Highlight the track you want to move, select the **"Track"** menu item, then choose **"Move"**. Now highlight the position to which you want to move the track and validate.

"Playlist"

-  - "**Clear**": clears the current playlist.
-  - "**Shuffle**": randomly shuffles the order of the songs in the current playlist.

"Save playlist"

-  - "**Save**": saves the current playlist to the **Playlists** folder.
-  - "**Save As**": same as "**Save**", but it also allows you to give a personalized name to the playlist. See: *Using the Virtual Keyboard*.

"Hide playlist"

-  - closes the playlist editor.

"Settings"

-  - you can choose to display the Music Player settings screen (see *Music Player Settings*) or the "**Sound**" settings screen (see: *"Sound" Settings*).

CREATING A NEW PLAYLIST

1. While you are in the Music browser, select the "**Show playlist**" menu item. A playlist panel will open on the right. By default, the new playlist contains the same songs as the last opened playlist. You can now start modifying the playlist.
2. In the left panel, locate the songs you would like to add to your playlist. Highlight a song and open it to add it to the playlist. Repeat this operation with all the tracks you want.

To add all the songs of a folder to a playlist: open the folder in the left panel and highlight the first song. Then use the "Add to playlist" or "Insert in playlist" menu item and choose "All files".

3. When you are satisfied with your new playlist, select the "**Save playlist**" menu item, and then choose "**Save as**".
4. Enter the name of your new playlist with the virtual keyboard (see: *Using the Virtual Keyboard*) and select "**OK**".

Use the tabs to jump back and forth between the left and right panels.

EDITING A PLAYLIST

To edit an existing playlist:

1. In the Music Library, highlight the "**Playlist**" line and open it.

2. Highlight the playlist you want to modify and open it. A panel showing the contents of the playlist will open on the right.
3. You can now add, shuffle, move or remove tracks within the playlist, using the appropriate menu items. The available menu items will vary according to which panel you selected (see: *Playlist Menu Items*).
4. After you have made the changes you want, select the "**Save playlist**" menu item and choose "**Save**" to save the playlist. If you wish to give it a different name, choose "**Save As**".

ADDING SONGS TO A PLAYLIST WHILE LISTENING TO MUSIC

1. While playing a song, use the tab button/icon to go back to the Music Library or Music Browser, and select the "**Show playlist**" menu item.
2. Your window will then have two panels: the music files on the left and the last-opened playlist on the right.
3. While listening to your song, you can edit the last-opened playlist.
4. Close the playlist editor  to return to the playback screen.

Please note: this can only be done if you have entered the "Music" folder via the "Music" icon in the Home screen and not via the "Files" icon.

2.5 PUTTING MUSIC ONTO YOUR ARCHOS

There are two main methods to transfer the music stored on your computer onto the ARCHOS:

1. Windows Media® Player: copy your music using Windows Media® Player 10 or higher*:



- Use Windows Media® Player 10 or higher* (**Sync** tab) to synchronize your computer's music files with the ARCHOS.
- See *Putting Files onto the ARCHOS* to learn more about how to transfer your computer's music files with Windows Media® Player.

** For best performance, we recommend that users update to Windows Media® Player 11 or higher.*

2. Windows® Explorer: Copy and paste your music files from your computer into the **Video** folder of your ARCHOS.

To learn how to connect/disconnect the ARCHOS from your computer, see the *Transferring Files* section.

TRANSFERRING YOUR CD COLLECTION TO YOUR ARCHOS

You can easily create audio content with your computer by using Windows Media® Player 10 or higher to convert your own CDs to MP3 or WMA format:

1. Place a music CD in your computer, and Windows® will ask you what action you would like to perform.
2. Choose **Rip music from CD**, and Windows Media® Player will start ripping the CD. The songs will be automatically extracted from the CD and encoded into the MP3 or WMA format, according to what you chose in Windows Media® Player's ripping options. The default format is WMA.
3. Once this is done, the album will become part of your Music Library.
4. See *Transferring Files* to learn how to transfer the ripped music files onto the ARCHOS.

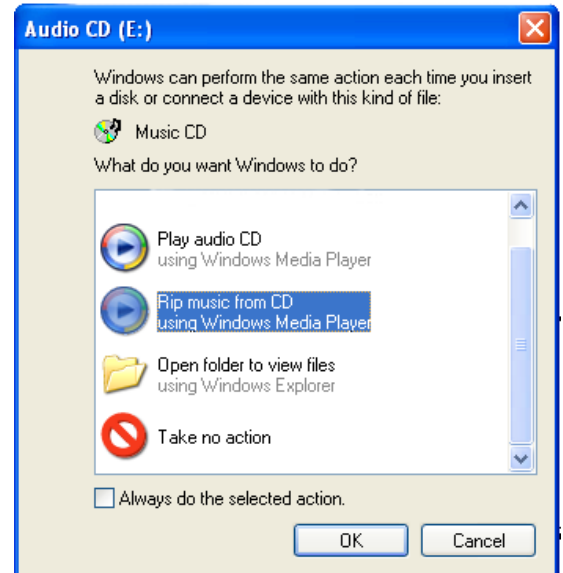

See your Windows Media® Player help instructions for more information.

- Check the laws and regulations in your country or jurisdiction to know if private copying of your CDs for your own use is authorized.
- Some music CDs have a special copy protection system that will not allow Windows Media® Player to make music files from them.

2.6 RECORDING ANALOGUE AUDIO



- With the optional DVR Station Gen 5 or DVR Travel Adapter (available at www.archos.com), your ARCHOS will be able to record audio from most any standard line level analogue audio source.
- See: *Optional Functionalities*.



DVR TRAVEL ADAPTER



DVR STATION GEN 5

605

705

2.7 PLAYING YOUR PC'S SHARED MUSIC



- When connected to your home WiFi network, your ARCHOS gives you the possibility to play, directly on your device, shared music stored in your PC's Windows Media® Library.
- For this to work, you will need a WiFi connection and Windows Media® Player 11 or higher* installed on your PC.
- The ARCHOS uses the UPnP (Universal Plug-and-play) standard to stream shared music from your PC's Windows Media® Library.
- See: *Playing your PC's Shared Media Files*.

*** There are other products on the market that also can share media files using the UPnP standard.**

3. VIEWING PHOTOS



In the Home screen, select the “**Photo**” icon to enter the Photo viewer.

3.1 BROWSING THROUGH YOUR PHOTOS

- The “**Photo**” browser allows you to navigate through the **Pictures** folder of the ARCHOS’ hard drive.
- You can go back one level in the hierarchy by closing the current screen . Wherever you are in the hierarchy, you can go back directly to the Home screen by pressing and holding down on the Exit icon/button.

THE PHOTO BROWSER

- The first screen of the Photo mode shows all the photos and subfolders located in the **Pictures** folder.
- To view a photo, highlight its thumbnail, then open it. If a photo is in a subfolder of the **Pictures** folder, open the subfolder, and you will see your photo.
- The Photo Browser also allows you to view your pictures, sorted by date.



In the “Photo” browser each photo is displayed with a thumbnail.

BROWSING THROUGH YOUR MEMORY CARD’S PHOTOS

(Depending on model)

- If you have inserted a memory card into the ARCHOS (see: *Memory Card Slot* to learn how to insert/remove a memory card), select the line “**SD/MMC card**”, in the first screen of the Photo mode.
- You can now browse the contents of your card and view your photos (if your card contains any). In Photo mode, only picture files and folders will appear.

When you insert a memory card, its contents (pictures) are automatically integrated into the Photo library (“All by date” and Browse by date” views).

PHOTO BROWSER MENU ITEMS*

"Info"

 - displays a message box with information about the highlighted picture.

"Delete"

 - allows you to delete the highlighted picture. A confirmation screen will pop up.

"Start slideshow"

 - starts a slideshow from the highlighted image.
- the **"Pause slideshow"** menu item will appear, allowing you to pause the slideshow.

"Settings"

 - will display the Photo viewer settings screen (see *Photo Viewer Settings*).

* *The available menu items will vary depending on where you are in the "Photo" Browser.*

3.2 PHOTO VIEWER

To view a picture, highlight the corresponding thumbnail and open it. The menu overlay will disappear automatically after a few seconds.



PHOTO VIEWER SCREEN



605

705

PHOTO VIEWER TOUCHSCREEN CONTROLS

- To display the menu overlay again, tap once anywhere on the screen. To make it disappear again, wait for a few seconds or tap on the Tab icon  in the top left corner.
- To display the next picture, drag the stylus (anywhere on the screen) from left to right. Drag from right to left to go back one picture.
- To rotate the picture 90° counterclockwise, drag the stylus (anywhere on the screen) from bottom to top. To rotate the picture 90° clockwise, drag from top to bottom.
- To magnify the current picture, hold down anywhere on the screen until you are satisfied with the zoom level. You can then drag the stylus (anywhere on the screen) to move inside the zoomed picture. To display the image in its original format, tap twice (rapidly) anywhere on the screen.
- To execute a menu item's function, simply tap on its icon. In order to display a text description of the icon, tap on the **menu** word.
- To close the picture and go back to the "**Photo**" browser, tap on . To exit the Photo mode and go back directly to the Home screen, hold down on the Exit icon.

405

605

PHOTO VIEWER BUTTON CONTROLS

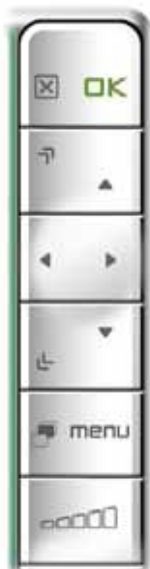

- press once: close the photo viewer and go back to the "**Photo**" browser
- hold: exit the Music mode and go back directly to the Home screen.



start/pause a slideshow



zoom in



left/right: previous/next picture



down/up: rotate 90° clockwise/counterclockwise



zoom out



display/hide the menu overlay



display available menu items



increase/decrease volume

PHOTO VIEWER MENU ITEMS

"Info"



- displays a message box with information about the current picture.

"Rotate"



- choose "**Left**" to rotate the picture 90° counterclockwise.

- choose "**Right**" to rotate the picture 90° clockwise.

"Start slideshow"



- starts a slideshow from the current image.

- the "**Pause slideshow**" menu item will appear, allowing you to pause the slideshow.

"Set as wallpaper"



- defines the current picture as your ARCHOS' background image.

"Settings"



- will display the Photo viewer settings screen (see next section).

"Zoom"



- use the slider to magnify/demagnify the current picture.

3.3 PHOTO VIEWER SETTINGS

- In the Photo mode, you can access the Photo viewer settings screen via the "**Settings**" menu item .
- Use the left/right arrows to select a different setting for a parameter.



"Picture Pause"

- defines the time that each picture will be displayed during a slideshow.

"Transition"

- defines the transition effect to be used between two pictures. There are several cool effects that you can choose from.

"Sequence"

- allows you to enable/disable the shuffle mode. If this parameter is set to "**Shuffle**", your pictures will be displayed randomly. To disable the shuffle mode, select "**Normal**".

"Format"

- allows you to change the way the picture is displayed.
- "**Original**": displays the entire picture in its original format.
- "**Full Screen**": enlarges the picture to fill the screen. In order to fit the ARCHOS' screen, your device might need to cut small parts of the image, most likely at the top and bottom.

3.4 PLAYING A SLIDESHOW

- To view a slideshow, highlight a picture file in the "**Photo**" browser or while viewing a photo, and choose the "**Start slideshow**" menu item.
- While a slideshow is playing, you can pause it at any time by selecting the "**Pause slideshow**" menu item.
- You can define the time that each picture is displayed and the transition effects in the "**Photo**" settings (see: "*Photo*" Settings).

3.5 VIEWING PHOTOS WHILE LISTENING TO MUSIC

You can view photos and play slideshows while listening to music:

- Choose the "**ARCHOS home screen**" menu item while playing a song.
- In the Home screen, select the "**Photo**" icon to enter the Photo mode.
- Browse through your photos (see: *Browsing Through your Photos*) or start a slideshow as normal (see: *Playing a Slideshow*).
- To go back to the Music playback screen, go to the Home screen and select the "**Music**" icon.

3.6 PUTTING PHOTOS ONTO YOUR ARCHOS

There are two main methods to transfer the pictures stored on your computer onto the ARCHOS:

1. Windows Media® Player: copy your pictures using Windows Media® Player 10 or higher*:



- Use Windows Media® Player 10 or higher* (**Sync** tab) to synchronize your computer's pictures with the ARCHOS.
- See *Putting Files onto the ARCHOS* to learn more about how to transfer your computer's pictures with Windows Media® Player.

** For best performance, we recommend that users update to Windows Media® Player 11 or higher.*

2. Windows® Explorer: Copy and paste your pictures from your computer into the **Video** folder of your ARCHOS.

To learn how to connect/disconnect the ARCHOS from your computer, see the *Transferring Files* section.

605

705

3.7 PLAYING YOUR PC'S SHARED PHOTOS



- When connected to your home WiFi network, your ARCHOS gives you the possibility to view, directly on your device, shared photos stored in your PC's Windows Media® Library.
- For this to work, you will need a WiFi connection and Windows Media® Player 11 or higher* installed on your PC.
- The ARCHOS uses the UPnP (Universal Plug-and-play) standard to stream shared photos from your PC's Windows Media® Library.
- See: *Playing your PC's Shared Media Files*.

** There are other products on the market that also can share media files using the UPnP standard.*

4. USING THE FILE BROWSER



The ARCHOS File Browser gives you the possibility to navigate the file system of your ARCHOS' hard drive. In the Home screen, select the "**Files**" icon to enter the File Browser.

You will see two panels:

- The one on the left is the panel that you usually use to navigate through your device's hard drive.
- The panel on the right is the one you will use when you want to copy or move files and folders (see: *Copying and Moving Files and Folders*).



About your ARCHOS' hard drive:

DO NOT delete or rename the original folders: "Music", "Pictures", "Video", Playlists, etc. The icons on the Home screen ("Video", "Music", "Photo"...) lead directly to these folders and they may no longer work correctly if the folders are deleted or renamed.

BROWSING THROUGH YOUR MEMORY CARD'S FILES

(Depending on model)

- If you have inserted a memory card into the ARCHOS (see: *Memory Card Slot* to learn how to insert/remove a memory card), select the line "**SD/MMC card**", in the first screen of the File browser.
- You can now browse the contents of your card. In the File browser, all files and folders will appear.



4.1 NAVIGATION

605

705

TOUCHSCREEN CONTROLS

- You can drag the scroll bar up and down to scroll the file list up and down. You can also scroll faster by tapping above or below the cursor in the scroll bar.

- To open a file or folder, tap on it to highlight it, then tap on it again.
- To jump between the left and right panels, tap on , or tap directly on the panel that you want to highlight.
- To execute a menu item's function, simply tap on its icon. In order to display a text description of the icon, tap on the **menu** word.
- You can go back one level in the hierarchy by tapping on  (see n° 1). Wherever you are in the hierarchy, you can go back directly to the Home screen by holding down on the Exit icon.

405

605

BUTTON CONTROLS



- press once: go back one level in the hierarchy
- hold: exit the File Browser and go back directly to the Home screen.



open a file or folder



scroll up the file list faster



left: go back up one level in the folder hierarchy



up/down: scroll the file list up and down



scroll down the file list faster



jump between the left and right panels.



display available menu items



increase/decrease volume

BROWSER MENU ITEMS

Note that some of the above menu items may not appear if they are not available for the highlighted file or folder.

"Info"



- displays a message box with information about the highlighted file.

"Create folder"



- creates a folder at the current location.

- you will have to enter the folder's name with the virtual keyboard (see: *Using the Virtual Keyboard*).

"File Management"

-  - **"Rename"**: allows you to change the name of the highlighted file or folder using the virtual keyboard. See: *Using the Virtual Keyboard*.
- **"Delete"**: allows you to delete the highlighted file or folder (and all its contents). A confirmation screen will pop up.

"Copy"

-  - **"Copy"**: allows you to copy the highlighted file or folder to the location defined in the other browser panel.
- **"Copy all files"**: allows you to copy all the files of the current folder to the location defined in the other browser panel.
- **"Move"**: allows you to move the highlighted file or folder to the location defined in the other browser panel.

COPYING AND MOVING FILES AND FOLDERS

- In the left panel, highlight the file/folder that you want to copy or move.
- In the right panel, navigate to the location where you wish to copy the file/folder to.
- Go back to the left panel, select the **"Copy"** menu item and then choose **"Copy"**, **"Copy all files"** or **"Move"**, depending on the action that you want to carry out.

4.2 USING THE VIRTUAL KEYBOARD

The virtual keyboard is an interface that allows you to type in text, for instance to rename a file or folder, or when you want to give a title to a playlist that you have just created.

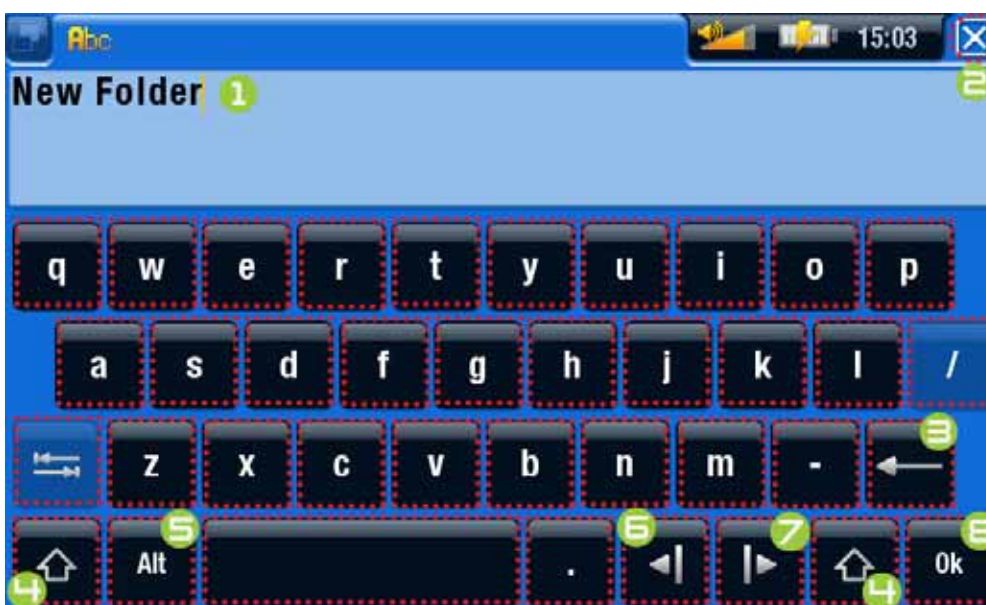

- *the virtual keyboard might vary according to your model.*
- *if a key is transparent, it means that it is disabled.*









1. current name of the file/folder
2. Exit icon
3. delete character before cursor
4. Shift key
5. Alt/Alt Gr key : enable/disable the keys' secondary functions
6. move cursor one character to the left
7. move cursor one character to the right
8. save the name.

605 705 KEYBOARD TOUCHSCREEN CONTROLS

- To enter a character, tap on the corresponding key.
- To exit the keyboard without saving, tap on  (see n° 2 in the previous screen).
- When you are satisfied with the name, tap on the **Ok** key (see n° 9) to save it and exit the keyboard. A confirmation screen will pop up.

405 605 KEYBOARD BUTTON CONTROLS



-  close keyboard without saving
-  enters the highlighted character
-  same as the Shift key
-  jump from one key to another
-  same as the Alt/Alt Gr key (*depending on model*)
-  -
-  menu -
-  -

4.3 USING THE FILE BROWSER WHILE LISTENING TO MUSIC

You can browse your files while listening to music:

- Choose the "**ARCHOS home screen**" menu item while playing a song.
- In the Home screen, select the "**Files**" icon to enter the File Browser and start browsing through your files.
- To go back to the Music playback screen, go to the Home screen and select the "**Music**" icon.

605

705

4.4 BROWSING OTHER COMPUTERS ON THE NETWORK

- When you are connected to a Windows® network, you can browse* the shared folders of other computers in the network, using the ARCHOS File Browser.
- From the Home screen, select the **"Files"** icon. In the left panel of the browser, select the first line in the list (**"Network"**). Your device will connect to your WiFi access point and then search for other computers in the Windows® network. You can then choose a computer and start browsing its shared folders.

** If the computer with the shared folders normally has a Windows® username and password, you will be asked to enter these before you can access the folder contents.*



Using the ARCHOS double browser, you will be able to play media files or transfer any file from a networked computer onto your device. You can also transfer files from your device onto a computer's write-enabled shared folder (see *Copying and Moving Files and Folders*).

If the WiFi is not enabled or if you are not connected to a network, the device will scan for available networks and connect to a known network or display the list of available networks so that you can connect to one of them.

4.5 USING THE PDF READER

- Your ARCHOS features a PDF reader with hyperlink support.
- In the Browser, PDF files are displayed with the  icon.
- To view a PDF document, highlight the PDF document in the File Browser and open it.

ATTENTION: The ARCHOS PDF reader may not implement all PDF features. For example, you will not be able to open password protected PDF files.

605

705

PDF TOUCHSCREEN CONTROLS

- To follow a link (red/blue outline), simply tap on it.
- To display the menu overlay while viewing a PDF document, tap once in the bottom right corner of the screen.
- To go to the next/previous page, tap on the "**Next/Previous page**" menu item.
- To exit the PDF reader, tap on .

405

605

PDF BUTTON CONTROLS

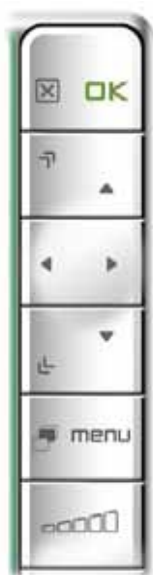

- 1st press: fit to width (if zoomed)
- 2nd press: exit PDF reader



follow a highlighted link



previous page



navigate within the current page



next page



-



display available menu items



-

FOLLOWING HYPERLINKS

- Some PDF documents have hyperlinks (for instance, a table of contents, links to an external website, etc.).
- Links are surrounded by a blue outline. A highlighted link (active link) is surrounded by a red outline.
- If you want to go back to the previous page (where you 'clicked' the link), select the "**Link back**" menu item.

Note that hyperlinks referring to an external document or to a URL may not work.

PDF READER MENU ITEMS

"Hide text overlay"

- will hide all overlaid graphics (status bar, menu items, etc.) to only show the PDF document.

"Zoom"

- allows you to adjust the zoom level.

"Previous page"

- goes to the previous page in the document.

"Next Page"

- goes to the next page in the document.

"Link back"

- will take you back to the page that you came from.
- only appears when you have previously followed a link.

"Go to page..."

- allows you to select a specific page.
- use the left/right buttons to select a page number.
- Select "**OK**" to go to this page.



5. CONNECTING TO A WIFI NETWORK



Your ARCHOS can connect to a variety of wireless networks. You will find below the procedure to connect to these different WiFi networks.

5.1 WIFI CONNECTION PROCEDURE

HOW TO IMPROVE WIFI RECEPTION

In order to improve your device's WiFi reception, avoid placing your fingers in front of the WiFi antenna area:



ARCHOS 605 WiFi





ARCHOS 705 WiFi

ENABLING WIFI

From the Home screen, select the "**Enable WiFi**" menu item . Your device will scan for available WiFi networks.

- The first time you use your device, you may get a message "**No configured network found**". Select "**View available networks**", and the list of available networks will be displayed.
- If you get the message "**Could not connect to any WiFi network!**", select "**View available networks**", and the list of available networks will be displayed.







Once you are connected to a WiFi network, the status bar icon  (WiFi not connected) will become  (WiFi connected). There is no status bar icon at all when WiFi is not enabled.

When you enter an application that uses the WiFi (Web Browser, ARCHOS Content Portal, etc. See: The WiFi Features), your ARCHOS will try to connect to the WiFi. If a configured network is detected, the ARCHOS will automatically connect to it and then launch the application.

THE LIST OF AVAILABLE NETWORKS

- The list of available networks shows all the wireless networks in range of your device.
- The list is constantly refreshed automatically.
- In the list of available networks, for each network you will see the following information:



1. Configuration status:  configured network  unconfigured network
2. The name of the network (SSID), if it is broadcasted (*if the SSID is not broadcasted, you will be prompted to enter it in the next configuration screen*).
3. The strength of the signal.
4. The type of encryption key that is required:
 -  Open network (no key)
 -  WEP key
 -  WPA key
 -  WPA2 key
5. The channel used by the network.
6. The type of network (Infrastructure or Ad-Hoc). *Ad-Hoc networks are not supported at this time.*
 - Select the network that you want to connect to (your home wireless network or a free hotspot).
 - You will be taken to the configuration screen for this network, where you will have to enter some information to set up your access to this network.

5.2 WIFI NETWORK CONFIGURATION

In order to connect to a wireless network, the ARCHOS will need some specific information about the network. Your device will automatically pick up certain pieces of information that it needs from the WiFi hot spot. You can enter the rest of the in-

formation manually in the network's configuration screen, as shown in the following sections.

Note that your device will remember the network connection information that you enter, in order to re-use it and connect automatically to the network when it is in range.

OPEN NETWORKS

- Open networks do not require an authentication key.
- If the network has automatic configuration turned on (DHCP), simply tap on the "**Connect**" button, and your ARCHOS will connect to this network, provided the signal is strong enough.
- If the network needs to be configured manually, use the left/right arrows to select the "**Manual**" setting on the "**Configuration**" parameter.
- Other parameters will appear: the required information can be obtained from the person who manages the network.

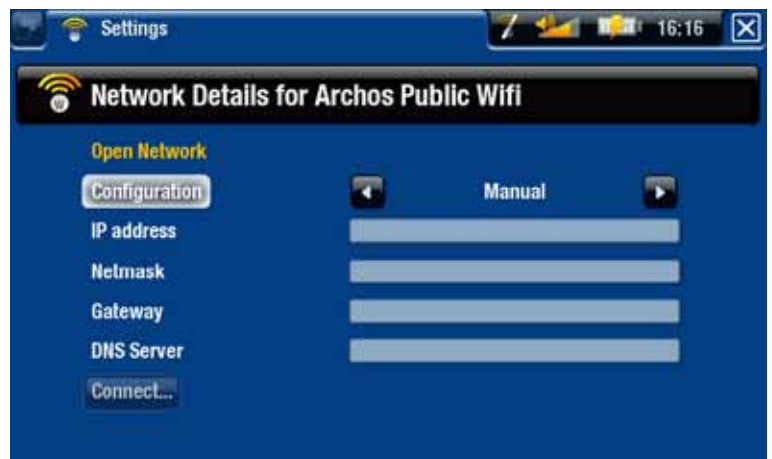

When you have finished entering all the information, tap on the "**Connect**" button, and your ARCHOS will connect to this network, provided the signal is strong enough.

PROTECTED NETWORKS (WEP, WPA OR WPA2 KEY)

- Protected networks require an encryption key to connect.
- The type of key (WEP, WPA or WPA2) will be detected automatically by your device.
- The rest of the required information can be obtained from the person who manages the network.



You will have to specify the following settings:

“Key length” (for WEP networks only)

- the authentication key can be 10 characters long (64bit) or 26 characters long (128bit).

“Key format” (for WEP networks only)

- in some cases you may need to change the key format in order to enter a pass-phrase/password. *See the documentation that came with your WiFi router or modem.*

“Key” (WEP or WPA)

- type in the authentication key.
- you will be taken to a virtual keyboard (see: *Using the Virtual Keyboard*).
- type in the key and tap on **“OK”** when you have finished.

“Authentication” (for WEP networks only)

- the network's authentication method can be based on an **“Open System (default)”** or a **“Shared Key”**.

“Configuration”

- it can be **“Automatic (DHCP)”** or **“Manual”**.
- if it is **“Automatic (DHCP)”**, then you do not have to enter any more information. Simply use the **“Connect”** button, and your ARCHOS will connect to this network, provided the signal is strong enough.
- if you must configure the network manually, select the **“Manual”** setting. Other parameters will appear: the required information can be obtained from the person who manages the network.

When you have finished entering all the information, use the **“Connect”** button, and your ARCHOS will connect to this network, provided the signal is strong enough.

***Filtered networks:** If your network manager allows only specific devices to connect to the network (known as MAC address filtering), you can supply the network manager with the MAC address of your ARCHOS. To find out what your MAC address is, select the “Settings” menu item from the Home screen, then choose “System”. See: “System” Settings.*



6. THE WIFI FEATURES



When connected to a WiFi network, your ARCHOS gives you the possibility to:

- rent or purchase on-line videos/music via the ARCHOS Content Portal. See: *The ARCHOS Content Portal*.
- browse the web with the optional Web Browser plug-in, available at www.archos.com. See next section.
- play shared media files stored on other computers in your network. See: *Playing your PC's Shared Media Files*.

6.1 BROWSING THE WEB



In order to browse the web, you will need the Web Browser plug-in, available at www.archos.com. With this Internet browser, specially designed for your ARCHOS, you will have the possibility to browse websites*, use web-based e-mailing, download content, etc.

**supports Flash™ content and Javascript. Java virtual machine not supported.*

LAUNCHING THE WEB BROWSER

From the Home screen, select the “**Web**” icon.

- If you are already connected to a network, the Web browser will simply open and you can start browsing the Web.
- If WiFi is not enabled or if you are not connected to a network, the device will scan for available networks and connect to a known network or display the list of available networks so that you can connect to one of them.
- Please note: not all wireless networks offer access to the Internet. Some WiFi networks only link several computers together, without any Internet connection.

If the time and date are not correctly set, you might not be able to access certain web pages (See: “Clock” settings). If you choose to set the clock automatically when the ARCHOS connects to a WiFi network, you will need to select your Country and City/Zone (see: “Language (and Region)” Settings).



USING THE WEB BROWSER

- You can use the Web browser to read your Web-based e-mail, view Web sites, and download documents from the Internet.
- The menu overlay will disappear after a few seconds.

- The Web browser features 'tabbed browsing'. You can have several pages opened at the same time. They will appear in the tabs area, in the upper left corner of the screen. When several pages are open, simply select a tab to access the page that you want. See next section.









WEB BROWSER TOUCHSCREEN CONTROLS

- You can use your stylus to scroll the current web page horizontally or vertically. To open a link, simply tap on it.
- To switch between the available tabs, tap on , or tap directly on the corresponding tab.
- To display the available menu items, tap on the **menu** word.
- When several tabs are displayed, tap on  to close the current one or hold down on the icon to close the Web browser and go back directly to the Home screen. When there is only one tab, tap on  to exit the Web browser.

605

WEB BROWSER BUTTON CONTROLS



-  - When several tabs are displayed: press once to close the current tab. Press and hold to close the Web browser and go back directly to the Home screen.
- When there is only one tab: press once to close the Web browser.
-  validate (enter button)
-  go to the next page that you browsed
-  scroll left/right/up/down
-  go to the previous page that you browsed
-  go to the next tab
- menu** display available menu items
-  increase/decrease volume

BROWSER MENU ITEMS

“Reload” / “Stop”

- will stop loading the web page, if it is currently loading.
- will refresh the current web page, if it has stopped loading.

“Navigation”

- **“Forward”**: will go to the next page that you browsed.
- **“Back”**: will go back to the previous page that you browsed.

“Zoom”

- changes the way the web page is displayed. Select a zoom mode.

“Go to”

- **“Enter URL...”**: allows you to enter the address of a Web site you'd like to visit. Enter the address with the virtual keyboard (see: *Using the Virtual Keyboard*). Select **“OK”** to open the website in the current window, or select **“Open in new tab”** to open it in a new window.
- **“Search...”**: allows you to search an address in one of the configured search engines. Enter the key words using the virtual keyboard (see: *Using the Virtual Keyboard*). Select **“OK”** to open the results in the current window, or select **“Open in new tab”** to open them in a new window.

“Favorites”

- will open the **“Favorites”** manager. Here you can add favorites, rename or delete them. Select a favorite and use the **“Open in new tab”** menu item to open the corresponding web page in a new window.

“Settings”

- will open the **“Web Browser”** settings screen. Here you can decide whether to accept/ignore popup windows, enable/disable flash content, delete your Internet history and cookies, etc.

Please note that some Web features requiring special plug-in software or Active X controls may not work in this special version of the Web Browser.

6.2 PLAYING YOUR PC'S SHARED MEDIA FILES

- When connected to your home WiFi network, your ARCHOS gives you the possibility to watch, directly on your device, shared media files (videos, music or photos) stored in your PC's Windows Media® Library.
- For this to work, you will need a WiFi connection and Windows Media® Player 11 or higher installed on your PC*.

- This is especially useful when you have a large library of music and video and you cannot fit it all onto the internal hard drive of the ARCHOS.
- The ARCHOS uses the UPnP (Universal Plug-and-play) standard to stream shared media files from your PC's Windows Media® Library.



Streaming one of your PC's shared videos and displaying it on your TV

** If you cannot install Windows Media® Player 11 or higher, it is possible to access and stream your PC's files from the ARCHOS File Browser. See Browsing Other Computers on the Network.*

SETTING WINDOWS MEDIA® PLAYER'S SHARING OPTIONS

1. Connect the ARCHOS to your WiFi network (see *Connecting to a WiFi Network*).
2. Connect your PC to the same WiFi network and start Windows Media® Player, version 11 or higher.
3. Click on the **Library** tab, and select **Media sharing...**
4. Check the box **Share my media to**, and click on **OK**. The ARCHOS' icon should appear in the window, with a warning symbol next to it*.

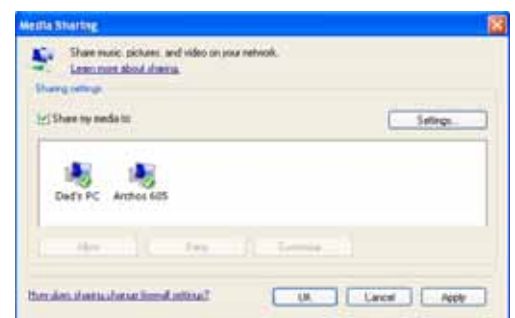
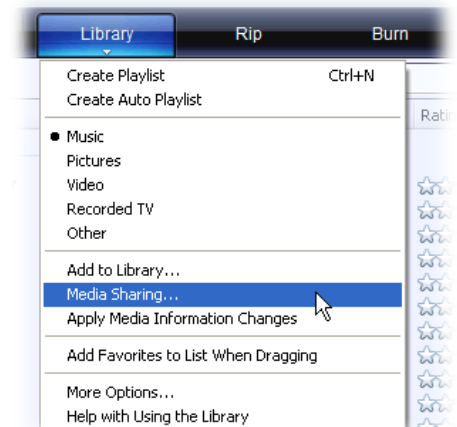

** ATTENTION: the first time you set your sharing options, it might take a couple of minutes for your PC to display the ARCHOS' icon.*

5. Select the ARCHOS' icon and click on the **Allow** button.
6. To modify your sharing settings, click on **Settings**. You can, for example, enter a name for your shared media files. You will then see this name on your ARCHOS. Click on **OK** to save the modifications.
7. Click on **OK** to close the **Media Sharing** window.
8. You can now close Windows Media® Player, and start viewing your PC's shared media files directly on your ARCHOS (see next section).

PLAYING YOUR SHARED MEDIA FILES ON THE ARCHOS

Your PC needs to be connected to the same WiFi network as the one the ARCHOS will connect to. You also need to have configured Windows Media® Player's sharing options (see the previous section).

1. On your ARCHOS, enter the Video, Music or Photo mode.
 2. You will notice that the first item in the list is the shared media files: "**Network 'UPnP'**". Open this item to start scanning for devices and computers sharing their media files on the WiFi network.
 3. If you entered a name for your shared media files in Windows Media® Player, it should appear. Open it, and you will see all your shared videos, songs or photos.
- If you are in the Video mode, you will then have access to all the videos stored in your PC's Windows Media® Library.
 - In the same way, the Music and Photo modes will allow you to access all the music/photos stored in your PC's Windows Media® Library.



Note: You may have some video files of very high quality and these require that the WiFi connection transfers data at a high speed. If your ARCHOS is far away from your WiFi box, it may happen that the connection speed is reduced thus not allowing some video files to stream from your PC to the ARCHOS and the television.

6.3 THE ARCHOS CONTENT PORTAL



- The ARCHOS Content Portal is an on-line store that offers several video and music partners. This portal gives you access to video and music content that is either free, for rent, or for purchase. No need for your computer, the media streams directly off the Internet into your ARCHOS.
- Or, if your ARCHOS is connected to the optional DVR Station Gen 5 you will be able to select your internet media content directly from your television.

1. In order to activate the ARCHOS Content portal, you will need to register your ARCHOS product on-line on the ARCHOS web site (www.archos.com/register).

2. Make sure you have configured your ARCHOS on a WiFi network (see: *Connecting to a WiFi Network*).



3. Select the ARCHOS "**Content Portal**" icon to view available on-line media stores and purchase videos or songs.

4. You can also visit the ARCHOS on-line store to purchase accessories.

Depending on your connection speed, you will have the possibility to start playing the video/song you purchased or rented while it's being downloaded. The videos/songs you get from the ARCHOS Content Portal are saved in the "Video"/"Music" folders.

7. TRANSFERRING FILES

7.1 CONNECTING THE ARCHOS TO A COMPUTER

CONNECTION STEPS

1. Plug the ARCHOS USB cable into the ARCHOS.
2. Plug the USB end of the cable into your computer.
3. The ARCHOS' icon will appear on your computer*. You can now start transferring files to it.

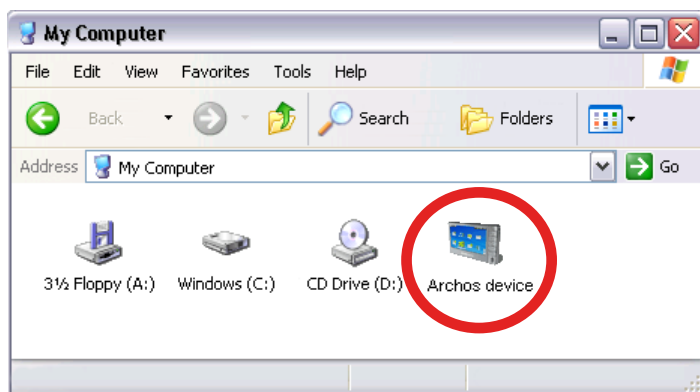

If you do not have Windows Media® Player 10 or higher installed on your computer, the ARCHOS will ask you if you want to charge its battery or connect it as a mass storage device (Hard Drive). Choose to connect it.

PUTTING FILES ONTO THE ARCHOS

There are two main methods to transfer your files onto the ARCHOS:

1. Copy your media files (videos, music, photos) with Windows Media® Player 10 or higher*:

** For best performance, we recommend that users update to Windows Media® Player 11 or higher.*

The Synchronize button in Windows Media® Player is a one way 'sync' button. It will add video, music and photo files to your ARCHOS. It will give you the possibility to have the same digital media on your ARCHOS as you have in your Windows Media® Player media library.



1. Connect your ARCHOS to the computer. See *Connecting the ARCHOS to a Computer*.
 2. On your computer, start Windows Media® Player.
 3. Select the **Sync** tab.
 4. Choose the media files you want to transfer.
 5. Click on the **Start Sync** button.
 6. The selected videos, songs or photos will be copied directly into the corresponding **Video**, **Music** or **Pictures** folder of the ARCHOS.
- See your Windows Media® Player help instructions for more information.

2. The second method is to use Windows® Explorer to copy and paste your files from your computer to the **Video**, **Music** or **Pictures** folder of your ARCHOS.

You cannot copy files larger than 2 GB to the ARCHOS due to the FAT32 file system constraints. For advanced users: in "PC Hard Drive" connection modes (mode 2 and 3), the maximum size is 2 GB for .AVI files and 4 GB for any other type of file. See: "System" Settings.

DISCONNECTING

When you disconnect the ARCHOS from a computer, your device automatically updates the ARCLibrary, so that the media files you just copied appear in the Music and Photo Libraries.

Windows® XP or higher & WMP10 or higher

- Verify that no data are being transferred between your ARCHOS and your computer (the HDD indicator on your ARCHOS is not flickering).
- Now unplug the USB cable from your ARCHOS and/or computer.

Windows® 2000 or Me

DO NOT SIMPLY PULL OUT THE CABLE AT ANY TIME! You must remove/unmount the ARCHOS from the computer before disconnecting the USB cable to avoid loss of data or freezing.

- Once all your transfers are finished, click on the 'safely remove' icon in the system tray, next to the clock.
- Click on the 'safely remove' message.

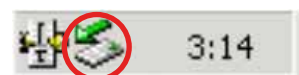

- A message will pop up, telling you that it is now safe to disconnect the device*. You can now safely unplug the USB cable from your ARCHOS and/or computer.



** If you get a message saying that the device cannot be removed, close any computer program that may still be using data on your device, such as media players or Windows® Explorer.*

Mac® OS X

DO NOT SIMPLY PULL OUT THE CABLE AT ANY TIME!

You must remove/unmount the ARCHOS from the computer before disconnecting the USB cable to avoid loss of data or freezing.

- On your desktop, drag the ARCHOS' icon towards the trashcan, which will turn into a big eject symbol.
- Drop the icon onto this eject symbol: the ARCHOS' hard drive will disappear from the desktop.
- You can now safely unplug the USB cable from your ARCHOS and/or computer.

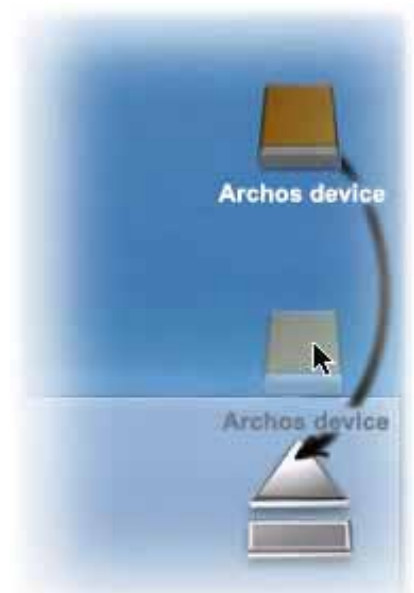

Linux

DO NOT SIMPLY PULL OUT THE CABLE AT ANY TIME!

You must remove/unmount the ARCHOS from the computer before disconnecting the USB cable to avoid loss of data or freezing.

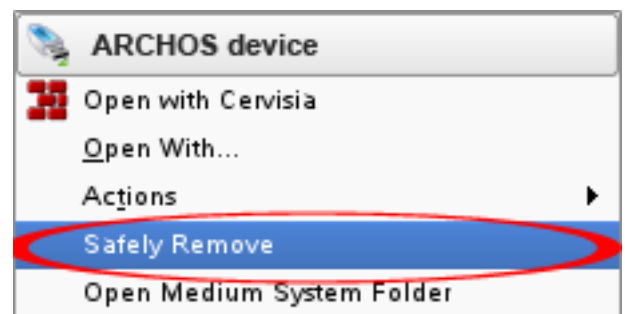

- On your computer, right-click on the ARCHOS icon and select Safely Remove.
- Wait until the ARCHOS icon disappears, and safely unplug the USB cable from your ARCHOS and/or computer.

705

7.2 USB HOST CONNECTION

- Thanks to the USB Host port, you can connect compatible USB devices to the ARCHOS, in order to transfer files or pictures to your ARCHOS.
- These devices can be Mass Storage Class (MSC) devices, such as digital cameras, card readers or external hard drives, or digital cameras using the Picture Transfer Protocol (PTP).

- Check your manufacturer's information to find out whether your device is an MSC or PTP device. Non Mass Storage Class devices such as printers, Ethernet adapters, mice, keyboards, etc. are not supported.



TO CONNECT A USB DEVICE TO YOUR ARCHOS DEVICE:

1. Turn on your ARCHOS device.
2. Plug the 'mini' end of the supplied USB host adapter into the ARCHOS device (A port).
3. Connect the external USB device (use a standard USB cable if needed) to the other end of the supplied USB host adapter.
4. Turn on the external USB device if needed (check the documentation of your external USB device).
5. A double browser window will appear on the ARCHOS: the external USB device will appear in the left panel, and your ARCHOS device's hard drive in the right panel.
6. Follow the instructions in the *Copying and Moving Files* section to copy your pictures or files to the ARCHOS.

TO DISCONNECT:

Make sure that no transfer is being made (the HDD light should not be flickering), select the "**Remove Safely...**" menu item (from the "**File**" Browser), and simply pull out the USB cable on either end.



Note 1: you may not always be able to copy files to your external USB device from your ARCHOS.

Note 2: you cannot connect your ARCHOS to a computer and connect an external device to your ARCHOS at the same time.



8. MAIN SETTINGS

In the Home screen, select the **"Settings"**  menu item and choose a setting.

605 705 USING THE TOUCHSCREEN

- Tap on the **"Settings"**  menu item, and choose a setting to open its corresponding screen.
- Once you are in a settings screen:
 - tap on a parameter to highlight it.
 - tap on the left/right arrows to select a different setting.
 - when you have finished adjusting your settings, tap on  to save them and go back to the Home screen.
 - When it is possible, tap on the up/down arrows to scroll the screen up and down.

405 605 USING THE BUTTONS

- To open a settings screen, press the **menu** button, use the navigation pad to highlight the **"Settings"**  menu item, and press **OK**.
- Once you are in a settings screen:
 - use the up/down navigation buttons to highlight a parameter.
 - use the left/right navigation buttons to select a different setting.
 - when you have finished adjusting your settings, press the **Exit** button  to save them and go back to the Home screen.
 - When it is possible, use the up/down navigation buttons to scroll the screen up and down.

8.1 "SOUND" SETTINGS

This screen allows you to adjust the sound settings of your ARCHOS to your personal taste.



"Built-in Speaker"

- **"ON"** / **"OFF"**: the built-in speaker remains on or off regardless if headphones are attached.
- **"Automatic"**: the built-in speaker automatically turns off when you plug in headphones or connect your ARCHOS to the optional DVR Station Gen 5.

"Audio Output"

- defines whether the audio signal is sent out via the **"Analog Line-Out"** or the **"SPDIF"** interface when connected to a DVR Station Gen 5.

"Bass Boost Level"

- adjusts the bass boosting level.

"Preset"

- allows you to quickly select a sound profile.

"Set Equalizer"

- allows you to use a custom sound profile. Select this option to enter the equalizer screen (see next section).

"Balance"

- allows you to balance the sound between the left and right stereo channels.

"Reset"

- resets the sound parameters to the default values.

"EQUALIZER" SCREEN

- Your ARCHOS features a 5-band equalizer.
- Select a band (Bass, Mid. bass, Mid. range, Mid. treble or Treble), then use the up/down arrows to change the gain level for these frequency ranges.

It is advised that you change these settings while listening to music, in order to be able to appreciate the sound changes.



8.2 "DISPLAY" SETTINGS



"LCD SETTINGS"

"LCD Backlight"

- adjusts the level of backlight of the built-in screen.

605 "Brightness/Contrast"

- use this button to adjust the display parameters of the built-in screen (contrast, brightness and gamma).
- you can also reset the LCD parameters to the default values ("**Reset**" button).



605 705 "Touch-Screen Calibration"

- If the touchscreen is not responding properly, use this button and follow the instructions on the screen.

ARCHOS 705: *If this does not work or if you cannot access the touchscreen settings, you can force the touchscreen calibration (see: System Recovery).*

405 "LCD stability"

- If you find that the LCD screen flickers, use this button to access the "**LCD stability**" screen.
- Press the left/right navigation buttons until the screen stops flickering.

"TV SETTINGS"

"TV Standard"

- choose between the "**NTSC (USA)**" and "**PAL (Europe)**" systems (select the one that is compatible with your country's television system).

"TV Format"

- "**4:3**" or "**16:9**" - the format used by your television set to display images.
- the option "**Wide screen**" becomes available when you set the "**TV standard**" parameter to "**PAL (Europe)**".

"TV Connection"

- when your ARCHOS is connected to the optional DVR Station Gen 5 (available at www.archos.com), select the type of video output ("**Composite**", "**S-Video**" or "**RGB**"), based on how you have connected the DVR Station Gen 5 to your TV.

8.3 "APPEARANCE" SETTINGS



"Picture name"

- allows you to select a picture to use as a wallpaper image. Select "**None**" if you do not want any background image.
- you can choose between all default backgrounds or the images that you have previously set as wallpapers.
- you can also set a picture as wallpaper from the Photo and Video modes.

"Theme color"

- defines the theme color for your icons (and for the background, if you have disabled the use of a wallpaper).

"Cancel"

- use this button to discard any changes you may have made since entering this screen.

8.4 "LANGUAGE (AND REGION)" SETTINGS



"Language"

- choose a language.
- visit www.archos.com to check the availability of other languages. New languages are included in the firmware as they become available. See *Updating the Firmware*.

605 705 "Select location"

- if your clock is set to "**Automatic**" (see "*Clock*" Settings), select your "**Country**", and "**City/Zone**".

605 705 "WiFi Region"

- this is configured automatically according to how you set your location.

8.5 "TV CONTROL" SETTINGS

- This is where you can set the DVR Station's IR emitter to communicate with your tuner. This will allow you to schedule recordings easily via the ARCHOS TV Program Guide (EPG).
- See the manual of the optional DVR Station Gen 5.

8.6 "CLOCK" SETTINGS



If you use the optional DVR Station Gen 5 to schedule video recordings on your TV system, make sure that the time and date are set correctly!

"Time Format"

- choose between 12h or 24h mode.

"Time setting"

- **"Automatic"**: select this parameter if you want to set the clock automatically when your ARCHOS is connected to a WiFi network. You will need to select your location in the **"Language (and Region)"** settings screen (see: *"Language (and Region)" Settings*).
- **"Manual"**: select this parameter to set the current date & time manually. The following parameters will appear: **"Hour"**, **"Minute"**, **"Year"**, **"Month"** and **"Day"**.

"Synchronize now"

- if the **"Time setting"** parameter is set to **"Automatic"**, use this button to set the clock automatically via a WiFi network.
- for this to work, the ARCHOS needs to be connected to a WiFi network.

ATTENTION: If the time & date are not correctly set, you might not be able to access certain web pages.

"Hour", "Minute", "Year", "Month", "Day"

- these parameters allow you to set the current time and date manually.

8.7 "POWER" SETTINGS

- These settings will help you save battery power, thus allowing a longer battery autonomy.
- You can adjust settings for both battery operation and power supply operation (when the ARCHOS is connected to a powered DVR Station Gen 5, Mini Dock or Battery Dock).



Your ARCHOS will consume more power as these parameters are set to higher values. In battery operation, it is advised to set these parameters to lower values in order to save power.

"Device Complete Power Off"

- If you do not plan on using the ARCHOS for an extended period of time, use this button to completely turn off your device, so that there is absolutely no battery usage.
- You can also turn off your device completely by holding the Power button until the second "shutdown" message appears*. See *ARCHOS Description*.

** Remember that when you release the Power button during the first "shutdown" message, your device will keep using a small amount of battery power to allow a quick start up.*

"BATTERY OPERATION"

"Power Off"

- the amount of time of user inactivity before the device shuts off.
- the device will not shut down during a slideshow, audio/video playback, audio/video recording, or USB connection.

"Backlight Off"

- the amount of time of user inactivity before the LCD display turns off.
- the display will not turn off while a video or slideshow is playing, or when you are browsing the web.

605

705

"Web Browser"

- **"Normal Power Off"**: while browsing the web, the ARCHOS will shut down according to the setting selected for the **"Power Off"** parameter.

- **“Prevents Power Off”**: while browsing the web, the ARCHOS will not shut off automatically from user inactivity.

“POWER SUPPLY OPERATION”

“Standby”

- the amount of time of user inactivity before the ARCHOS goes into Standby mode.
- the system will not go into Standby mode during a slideshow, audio/video playback, audio/video recording, or USB connection.

“Backlight Off”

- the amount of time of user inactivity before the LCD display turns off.
- the display will not turn off while a video or slideshow is playing.

605 705 “Web Browser”

- **“Normal Standby”**: while browsing the web, the ARCHOS will go into Standby mode according to the setting selected for the **“Standby”** parameter.
- **“Prevents Standby”**: while browsing the web, the system will never go into Standby mode.

8.8 “FIRMWARE AND PLUG-INS” SETTINGS



“Firmware Ver.”

- displays the current version of the firmware and Digital Rights Management (DRM) system.

“Plug-ins”

- displays the current plug-ins installed on your device.

“Product Key”

- each ARCHOS has a unique number.
- you will need this number to register your product online (www.archos.com/register).

"Firmware Update"

- use this button to update the firmware manually (see: *Updating the Firmware*)

"Online Firmware Update"

- use this button to search for an online update via a WiFi network. If there is one available, it will be installed automatically. See *Updating the Firmware* to learn more.

8.9 UPDATING THE FIRMWARE

The firmware is the operating system (OS) of your ARCHOS. It is periodically updated to bring new features, improvements and bug fixes. There are two main ways to update your product's firmware:

- Directly on your ARCHOS if your device can connect to a WiFi network.
- With a computer connected to the internet

UPDATE DIRECTLY ON THE ARCHOS (WIFI CONNECTION NEEDED)

This is the easiest way to update the firmware. For this to work, you only need an access to a WiFi network. See *Connecting to a WiFi Network*.

1. From to the Home screen, select the "**Settings**"  menu item, and choose "**Firmware and Plug-ins**".
2. Use the "**Online Firmware Update**" button.
3. The ARCHOS will connect to the WiFi and search on-line for a new firmware. If there is one available, it will start downloading, and it will be installed automatically.

UPDATE USING A COMPUTER (INTERNET CONNECTION NEEDED)

If you do not have access to a WiFi network, or if your ARCHOS is not WiFi-enabled, you can also update the firmware using a computer connected to the internet:

1. On your PC, go to www.archos.com/firmware.
2. Search for the latest firmware available for your ARCHOS.
3. Compare the latest on-line version with the one installed on your ARCHOS: your ARCHOS' firmware version number appears in the "**Firmware and Plug-ins**" settings screen (see: *"Firmware and Plug-ins" Settings*).
4. If the on-line version is more recent than yours, follow the instructions to download and install the new firmware.

Your Internet browser may warn you that the contents of the firmware file could harm your computer. ARCHOS has taken precautions to insure that this file will not harm your computer.

8.10 "SYSTEM" SETTINGS



"Free Storage Space"

- displays the amount of free space on the hard drive.

Note: reported number of megabytes is binary-based counting (1Kb=1024 bytes). Thus each reported Mb represents approximately 1.05 megabytes (decimal), and each reported Gb represents approximately 1.07 gigabytes. Formatting also takes up space.

"USB preference" (for advanced users)

- Your preferred connection mode will be used every time you connect the ARCHOS to a computer. The connection mode determines how your device interacts with your computer:
- Mode 1: "**Windows Media Device**": Recommended for users of Windows Media® Player (WMP) version 10 or higher. When set to this mode, the ARCHOS uses the Media Transfer Protocol (MTP). It allows you to charge your ARCHOS and transfer files onto it at the same time. Your ARCHOS will be locked only when it is opened in Windows® Explorer. You will be able to synchronize your media library automatically every time you connect your ARCHOS to your computer. When your file transfer is finished, simply unplug the cable from the ARCHOS, and your device will update the ARCLibrary (Music/Photo libraries).
- Mode 2: "**PC Hard Drive**": Recommended for users of Windows® XP with Windows Media® Player 9, Windows® 2000, Me, Mac® OS X or Linux. The ARCHOS will ask you if you want to charge it or connect it as a mass storage device (Hard Drive). Choose to connect it as a mass storage device (external hard drive). When connected to your computer, your ARCHOS will be locked. Disconnection: when the file transfer is over, safely unmount the ARCHOS (See: *Disconnecting*) and your device will do a quick ARCLibrary update (Music/Photo libraries). May not index all files.
- Mode 3: "**PC Hard Drive (auto-ARCLib)**": Same as mode 2, but with a full ARCLibrary update (Music/Photo libraries) at disconnection.

"Update ARCLibrary"

- Available only when "**USB Preference**" is set to "**PC Hard Drive**" (mode 2).
- This USB mode only does a quick ARCLibrary update (Music/Photo libraries). Use the "**Update ARCLibrary**" button if you want to do a full ARCLibrary update.

"Product Key"

- each ARCHOS has a unique number.
- you will need this number to register your product online (www.archos.com/register).

"MAC address"

- some WiFi networks filter MAC addresses. You might need to communicate this address to the person who manages the network.

"Repair and Formatting Tools"

- use this button to access the **"Repair and Formatting Tools"** settings screen. This screen allows you to do the following actions:

- **"Clear temporary system files and cache"** (does not erase any data)
- **"Reset Settings"** (resets all user settings)

(Depending on model) - **"Format SD/MMC card"** (erase all data in your memory card, if you have inserted one in your device)

- **"Format Hard Drive / Internal memory"** (erase all data, media files, and licenses)
- **"Full Reinitialization"** (erase all data, media files, licenses and settings)

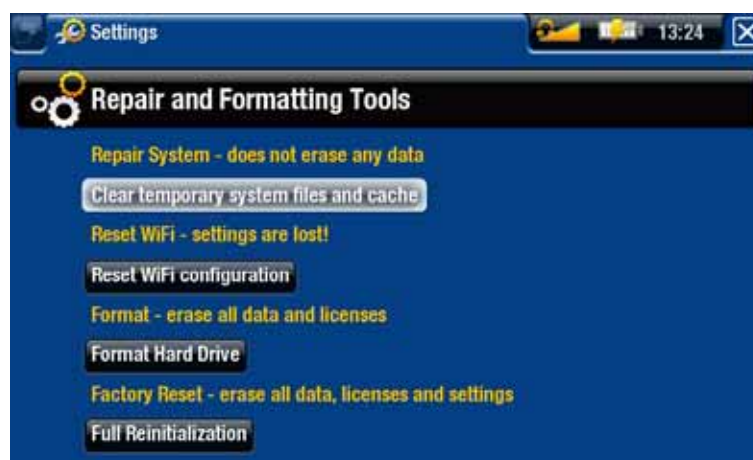

In the event that your ARCHOS freezes or does not respond anymore, try to reset it (see: Troubleshooting).

If this does not work or if you cannot access the Repair and Formatting Tools, you can try a system recovery (see: Troubleshooting).

9. OPTIONAL FUNCTIONALITIES

9.1 ARCHOS ACCESSORIES

DVR STATION GEN 5



When connected to your ARCHOS and to your home entertainment system, the DVR Station Gen 5 will allow you to:

- schedule TV recordings easily via the ARCHOS TV Program Guide (EPG) (available for most countries).
- record video directly to your ARCHOS, from your cable box, satellite receiver, digital tuner, or most any standard video source.
- connect a compatible USB device to your ARCHOS (Mass storage or PTP).
- play video back to your TV.
- charge your ARCHOS.

405

605

DVR TRAVEL ADAPTER



When connected to your ARCHOS, the DVR Travel Adapter will allow you to:

- record audio/video, directly on your ARCHOS, from most any standard audio/video source.

405

605

MINI DOCK



When connected to your ARCHOS, the Mini Dock will allow you to:

- display the image of the ARCHOS on your TV.
- connect a compatible USB device to your ARCHOS (Mass storage or PTP).
- charge your ARCHOS.

405

605

BATTERY DOCK



The battery dock is like the Mini Dock but also includes a battery to give your ARCHOS extra play time.

405

605

HELMET CAMCORDER



High resolution Mini-Cam with remote control and microphone.

9.2 ARCHOS PLUG-INS

CINEMA PLUG-IN



To allow you to play MPEG-2 (.VOB) video files without any re-encoding (type of file found on DVDs). Also allows playback of AC3 audio format.

VIDEO PODCAST PLUG-IN



To allow you to play H.264 video files without any special re-encoding (type of file often used for video podcasts). Also allows playback of AAC music files (non-protected).

605

705

WEB BROWSER PLUG-IN



A specially designed Internet browser for your ARCHOS that will allow you to surf the web on your ARCHOS. Supports websites with Flash™.

9.3 SCHEDULING A TV RECORDING



With the optional DVR Station Gen 5 connected to your home tuner (cable box, satellite receiver, digital tuner or VCR), you will be able to schedule recordings easily via the ARCHOS TV Program Guide (EPG).

1. In the Home screen, select the "**Recorder**" icon to display the ARCHOS TV Program Guide (EPG).

- This screen's menu items will allow you to choose a different day, update the Program Guide data, or change various settings (program guide update and channel list configuration).
- Navigate through the different TV programs, and simply select the one you wish to record.



- When the time comes, your ARCHOS will automatically start recording the scheduled program.

The manual that comes with the DVR Station Gen 5 will tell you more about how to setup and use the TV Program Guide.

9.4 RECORDING EXTERNAL VIDEO MANUALLY



With the optional DVR Station Gen 5, DVR Travel Adapter or Helmet CamCorder, you will be able to record video from most any standard video source:

- In the Home screen, select the "**Recorder**" icon and use the tabs to access the "**Video Recorder**" mode.
- This screen will allow you to adjust the recording sound volume (left/right arrows), or change various settings (scheduling and video parameters).
- You can now tell the ARCHOS to start recording from the video source ("**Start Recording**" yellow icon/menu item).
- Close the screen  to stop and save the recording*.

The manual that comes with the DVR Station Gen 5 or DVR travel Adapter will tell you more about how to record external video manually.

** All video recordings made by your ARCHOS device are saved in the "Video/ (REC)" folder. If you wish to keep them in a different location, you can use the "Move" function of the ARCHOS file browser after recording (see: Using the File Browser).*

9.5 RECORDING EXTERNAL AUDIO MANUALLY



With the optional DVR Station Gen 5 or DVR Travel Adapter, you will be able to record audio from most any standard audio source.

1. In the Home screen, select the "**Recorder**" icon and use the tabs to access the "**Video Recorder**" mode. Then select the "**Audio Recorder**" menu item.
2. This screen will allow you to adjust the recording sound volume (left/right arrows), or change various settings (recording title, audio format).
3. You can now tell the ARCHOS to start recording from the audio source ("**Start Recording**" yellow icon/menu item).
4. Close the screen  to stop and save the recording*.

The manual that comes with the DVR Station Gen 5 or DVR Travel Adapter will tell you more about how to record external audio manually.

** All audio recordings made by your ARCHOS device are saved in the "Music/ (Rec)" folder. If you wish to keep them in a different location, you can use the "Move" function of the ARCHOS file browser after recording (see: Using the File Browser).*

9.6 DISPLAYING THE ARCHOS ON A TV

- With the optional DVR Station Gen 5, Battery Dock or Mini dock, you will be able to display the image of the ARCHOS on your TV.
- Connect the ARCHOS with the adapter to the TV, press the **TV/LCD** button on the ARCHOS, and the display of the ARCHOS will switch to the TV.
- When the image is displayed on a TV, the **TV/LCD** LED indicator lights up and the built-in LCD screen turns off.

The manual that comes with the DVR Station Gen 5, Battery Dock or Mini dock will tell you more about how to display the image of the ARCHOS on your TV.

TROUBLESHOOTING

RESETTING YOUR ARCHOS

- In the event that your ARCHOS freezes or does not respond anymore, try to reset it: press the  button for 15 seconds (the ARCHOS will shut down completely) and turn it on as usual.
- If this does not work, you can also press the "master reset" button as shown below. You can use the end of a paper clip to press the button in the hole.

 On the left side of the device:



 Underneath the device:



 At the back of the device, behind the battery:

(see: Replacing the Battery)



Note: Resetting your ARCHOS will not erase any data from your device. However some settings will be reset to their factory defaults.

SYSTEM RECOVERY

- If your ARCHOS does not respond correctly, or does not show certain songs or videos that you have copied to it, try using the **“Repair and Formatting Tools”** (see: *System Settings*).
 - If using the **“Repair and Formatting Tools”** did not solve your problem, you can try a system recovery. It allows you to repair the hard drive, format it, etc.
1. Press the  button to turn on your device.
 2. When the built-in LCD screen turns on, immediately press and hold the **TV/LCD** button until the Recovery mode starts (white screen).

405

605

To move from an option to another, use the up/down Navigation buttons. To validate an option, press OK.

705

Since the system recovery mode is activated, the touchscreen is currently disabled. To move from an option to another, press the TV/LCD button. To validate an option, press and hold the TV/LCD button until the line flashes, and release it.

The system recovery mode gives you several options:

“No”

- cancels the system recovery.

“Repair Disk”

- attempts to repair the file structure on the hard drive.
- does not erase any data.

“Format Disk”

- formats the hard drive.
- all data (music, photos, videos, etc.), licenses and settings are erased.

705

“Force Touchscreen Calibration”

- use this option if the touchscreen does not respond correctly and if you cannot access the touchscreen settings (see: *Display Settings*).
- follow the instructions on the screen.

605 705 TOUCHSCREEN PROBLEMS

- If the touchscreen is not responding properly, or if it is not responding at all, go to the “**Display**” settings screen.
- Then use the “**Touch-Screen Calibration**” button, and follow the instructions on the screen.
- See: “*Touch-Screen Calibration*”.



ARCHOS 705: If this does not work or if you cannot access the touchscreen settings, you can force the touchscreen calibration (see: System Recovery).

REPAIR AND FORMATTING TOOLS

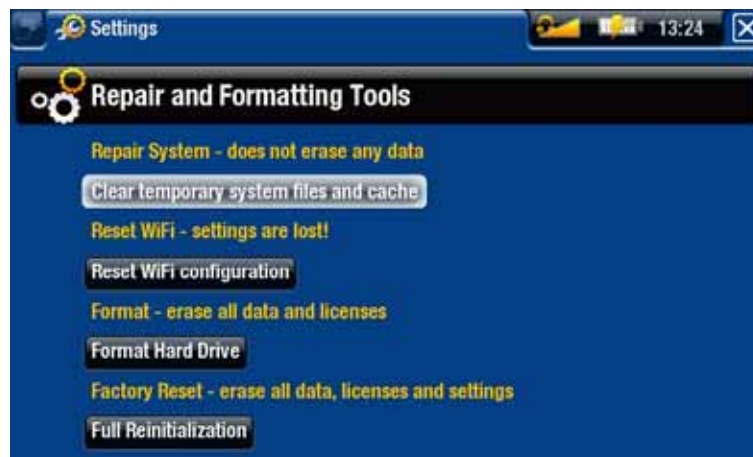

- to access the “**Repair and Formatting Tools**” settings screen: from the Home screen, select the “**Settings**” menu item, choose “**System**”, then use the “**Repair and Formatting Tools**” button. This screen allows you to do the following actions:
 - “**Clear temporary system files and cache**” (does not erase any data)
 - “**Reset Settings**” (resets all user settings)
 - “**Format SD/MMC card**” (erase all data in your memory card, if you have inserted one in your device)
 - “**Format Hard Drive / Internal memory**” (erase all data, media files, and licenses)
 - “**Full Reinitialization**” (erase all data, media files, licenses and settings)
- (Depending on model)

In the event that your ARCHOS freezes or does not respond anymore, try to reset it (see: Resetting your ARCHOS).

If this does not work or if you cannot access the Repair and Formatting Tools, you can try a system recovery (see: System Recovery).

705 REPLACING THE BATTERY

The ARCHOS has a removable battery. You can purchase extra batteries from www.archos.com.

Caution: *if the battery is incorrectly replaced or short-circuited, this could result in damage to the product and/or serious injuries to the user. Replace only with an original ARCHOS battery.*

To replace the battery, follow these steps:

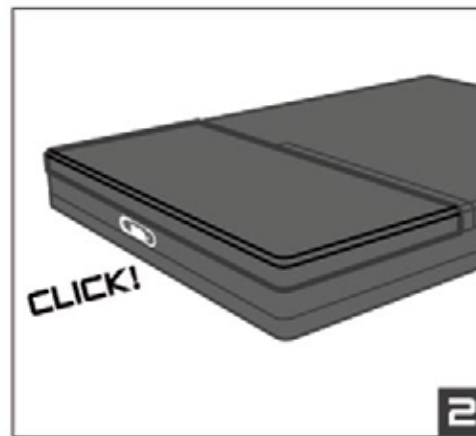
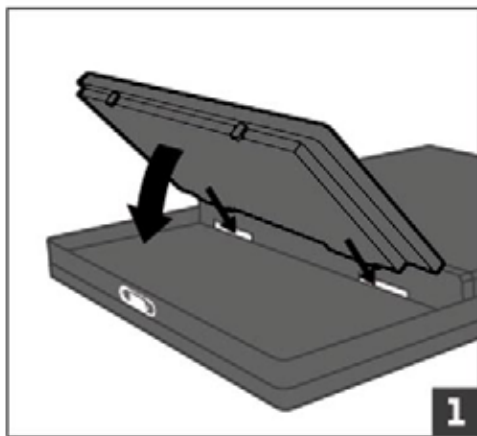

TECHNICAL SPECIFICATIONS

CAPACITY

- See *packaging*.

DISPLAY



- 7" TFT Touchscreen (800x480 pixels), 262,000 colors



- High resolution 4.3" TFT LCD, 16 million colors, 800x480 pixels.

- Touch Screen



- High resolution 3.5" TFT LCD, 320 x 240.

VIDEO PLAYBACK**

- MPEG-4⁽²⁾ (ASP@L5 AVI, up to DVD resolution).
- WMV (MP@ML, up to DVD resolution).
- With optional software plug-ins (available for purchase at www.archos.com):
 - Video Podcast plug-in: H.264 up to DVD resolution and AAC.
 - Cinema Plug-in: MPEG-2 MP@ML up to 10 Mbps (up to DVD resolution) and AC3 stereo sound (5.1).

AUDIO PLAYBACK**

- Stereo MP3 decoding @ 30-320 Kbits/s CBR & VBR, WMA, Protected WMA, WAV (PCM/ADPCM).
- With optional software plug-ins (available for purchase at www.archos.com):
 - AAC⁽³⁾ stereo audio files.
 - AC3 stereo audio and 5.1 sound files.

PHOTO VIEWER***

- JPEG, BMP, PNG.

PDF VIEWER

- Reads PDF documents. May not implement all PDF features.

VIDEO RECORDING⁽⁴⁾

- Via the optional DVR Travel Adapter (ARCHOS 405 and 605 only) or DVR Station Gen 5. Records NTSC/PAL/SECAM to MPEG-4 SP files with ADPCM stereo sound, VGA resolution (640 x 480)@ 30 or 25 f/s, in AVI format.

AUDIO RECORDING

- Via the optional DVR Travel Adapter (ARCHOS 405 and 605 only) or DVR Station Gen 5: stereo line-in, WAV (IMA ADPCM or PCM) format.

INTERFACES

- USB 2.0 High-Speed Device (compatible USB 1.1): Mass Storage Class (MSC) and Media Transport Protocol (MTP).
- USB 2.0 Host: Mass Storage Class (MSC) and Picture Transfer Protocol (PTP / for ARCHOS 405 and 605: only with optional Mini Dock, Battery Dock and DVR Station Gen 5).

CONNECTIONS

ARCHOS 405:

- SD Slot compatible with SD (and mini/micro SD with adapter), MMC (and RS MMC with adapter)
- USB 2.0 port
- 3.5 mm mini jack for headphones
- Docking connectors to connect DVR Station Gen 5 and other ARCHOS accessories

ARCHOS 605:

- *(Only on the models that feature a built-in flash memory)* SD Slot compatible with SD (and mini/micro SD with adapter), MMC (and RS MMC with adapter)
- WiFi (802.11g) connection. Optional Internet plug-in (Opera® web browser - supports Adobe Flash® content) for Web browsing (for purchase on www.archos.com)
- 3.5 mm mini jack for headphones
- Docking connectors to connect DVR Station and other ARCHOS accessories

ARCHOS 705:

- WiFi (802.11g) connection. Optional Internet plug-in (Opera® web browser - supports Adobe Flash® content) for Web browsing (for purchase on www.archos.com)
- 3.5 mm mini jack for headphones or TV output (PAL & NTSC)
- DC-in to connect power adapter/charger
- Mini B for USB 2.0 computer connection
- Mini A for USB 2.0 host connection
- Docking connectors to connect DVR Station Gen 5 and other ARCHOS accessories

SPEAKERS

- A single built-in speaker (ARCHOS 605) or two built-in speakers (ARCHOS 705)

POWER SOURCE

- Internal: Lithium-Ion Polymer battery.
- ARCHOS 405 and 605: Device charges via computer USB port.
- External: Power adapter/charger (for ARCHOS 405 and 605: via optional accessories).

SCALABILITY

- Downloadable firmware updates.

PACKAGE INCLUDES

ARCHOS 405:

- ARCHOS device, headphones, USB cable, protective pouch, DVR Adapter, Quick Start Guide (QSG), legal and safety notice.

ARCHOS 605:

- ARCHOS device, headphones, ARCHOS USB cable, protective pouch, DVR Adapter, 2 styli, Quick Start Guide (QSG), legal and safety notice.

ARCHOS 705:

- ARCHOS device, headphones, ARCHOS USB cable, USB host adapter, protective pouch, DVR Adapter, 2 styli, remote control, power adapter/charger, Quick Start Guide (QSG), legal and safety notice.

COMPUTER SYSTEM REQUIREMENTS

- For Computer:
 - PC with Windows® ME, 2000, XP, Vista, Media Center.
 - Macintosh® OS X or higher (with USB Mass Storage Class support).
 - Linux (with mass storage device support), USB port.
- For PlaysForSure™ audio, video and subscription services: PC with Windows® XP SP1 or higher, Windows Media® Player 10 or higher, and USB 2.0 port.

****** Certain bitrates, resolutions, and/or file variations may not be compatible.

******* Certain resolutions and file sizes may not be compatible.

⁽²⁾ MPEG-4 ASP@L5 AVI (MPEG-4: ISO standard by Moving Picture Experts Group; AVI: audio/video file container by Microsoft) without GMC and Quarter Pixel and WMV (including protected WMV).

⁽³⁾ Does not read AAC protected files.

⁽⁴⁾ External video output disabled for Macrovision®-protected contents.

LCD PIXEL POLICY

The LCD screen on your ARCHOS unit has been manufactured to rigorous standards to provide a high quality viewing experience. Nevertheless, your LCD screen may have slight imperfections. This is not particular to the ARCHOS screen, but to all devices which have LCD screens regardless of the original manufacturer of the LCD. Each product vendor guarantees that his screen will contain no more than a certain number of defective pixels. Each screen pixel contains three dot elements (Red, Blue, and Green). One or all of the dots in a given pixel may be stuck on or stuck off. A single dot stuck off is the least noticeable. All three dots of a pixel stuck on is the most noticeable.

 ARCHOS guarantees that this device's screen will have no more than 3 defective pixels (regardless if these pixels have one or more defective dots). This means that during the period of guarantee for your country or jurisdiction, if the screen on your product has four or more defective pixels, ARCHOS will repair or replace your product at its cost. Thus, three or less defective pixels is not grounds for replacement or repair of the product.

 ARCHOS guarantees that this device's screen will have no more than 2 defective pixels (regardless if these pixels have one or more defective dots). This means that during the period of guarantee for your country or jurisdiction, if the screen on your product has three or more defective pixels, ARCHOS will repair or replace your product at its cost. Thus, two or less defective pixels is not grounds for replacement or repair of the product.

TECHNICAL SUPPORT INFORMATION

Need Help? You can find the information you need:

- On our Website: see the frequently asked questions section on www.archos.com/faq
- By asking our technical support team: visit www.archos.com/support for e-mail support.
- U.S. & Canada: Call 877-300-8879 (toll free).

All brands and product names are registered trademarks and the property of their respective owners. Windows Media® and Windows® are trademarks or registered trademarks of Microsoft Corporation in the United States and/or other countries. Specifications are subject to change without notice. Errors or omissions excepted. Images and illustrations may not always match contents. All the information contained in this guide was correct at the time of publication.

COPYRIGHT ARCHOS © 2007. All rights reserved.

Free Manuals Download Website

<http://myh66.com>

<http://usermanuals.us>

<http://www.somanuals.com>

<http://www.4manuals.cc>

<http://www.manual-lib.com>

<http://www.404manual.com>

<http://www.luxmanual.com>

<http://aubethermostatmanual.com>

Golf course search by state

<http://golfingnear.com>

Email search by domain

<http://emailbydomain.com>

Auto manuals search

<http://auto.somanuals.com>

TV manuals search

<http://tv.somanuals.com>