



DSEB-DG ***Series***

DSEB-DG
DSEB-DG/SAS

Motherboard

E3469

First Edition V1
November 2007

Copyright © 2007 ASUSTeK COMPUTER INC. All Rights Reserved.

No part of this manual, including the products and software described in it, may be reproduced, transmitted, transcribed, stored in a retrieval system, or translated into any language in any form or by any means, except documentation kept by the purchaser for backup purposes, without the express written permission of ASUSTeK COMPUTER INC. ("ASUS").

Product warranty or service will not be extended if: (1) the product is repaired, modified or altered, unless such repair, modification or alteration is authorized in writing by ASUS; or (2) the serial number of the product is defaced or missing.

ASUS PROVIDES THIS MANUAL "AS IS" WITHOUT WARRANTY OF ANY KIND, EITHER EXPRESS OR IMPLIED, INCLUDING BUT NOT LIMITED TO THE IMPLIED WARRANTIES OR CONDITIONS OF MERCHANTABILITY OR FITNESS FOR A PARTICULAR PURPOSE. IN NO EVENT SHALL ASUS, ITS DIRECTORS, OFFICERS, EMPLOYEES OR AGENTS BE LIABLE FOR ANY INDIRECT, SPECIAL, INCIDENTAL, OR CONSEQUENTIAL DAMAGES (INCLUDING DAMAGES FOR LOSS OF PROFITS, LOSS OF BUSINESS, LOSS OF USE OR DATA, INTERRUPTION OF BUSINESS AND THE LIKE), EVEN IF ASUS HAS BEEN ADVISED OF THE POSSIBILITY OF SUCH DAMAGES ARISING FROM ANY DEFECT OR ERROR IN THIS MANUAL OR PRODUCT.

SPECIFICATIONS AND INFORMATION CONTAINED IN THIS MANUAL ARE FURNISHED FOR INFORMATIONAL USE ONLY, AND ARE SUBJECT TO CHANGE AT ANY TIME WITHOUT NOTICE, AND SHOULD NOT BE CONSTRUED AS A COMMITMENT BY ASUS. ASUS ASSUMES NO RESPONSIBILITY OR LIABILITY FOR ANY ERRORS OR INACCURACIES THAT MAY APPEAR IN THIS MANUAL, INCLUDING THE PRODUCTS AND SOFTWARE DESCRIBED IN IT.

Products and corporate names appearing in this manual may or may not be registered trademarks or copyrights of their respective companies, and are used only for identification or explanation and to the owners' benefit, without intent to infringe.

Contents

Notices.....	vii
Safety information	viii
About this guide	ix
Typography	x
DSEB-DG Series specifications summary	xi
Chapter 1: Product introduction	
1.1 Welcome!	1-1
1.2 Package contents.....	1-1
1.3 Serial number label	1-1
1.4 Special features.....	1-2
1.4.1 Product highlights	1-2
1.4.2 Innovative ASUS features	1-4
Chapter 2: Hardware information	
2.1 Before you proceed	2-1
2.2 Motherboard overview	2-3
2.2.1 Placement direction	2-3
2.2.2 Screw holes	2-3
2.2.3 Support kits for the motherboard	2-4
2.2.4 Motherboard layouts	2-7
2.2.5 Layout contents.....	2-9
2.3 Central Processing Unit (CPU)	2-11
2.3.1 Installing the CPU	2-11
2.3.2 Installing the CPU heatsink and fan	2-14
2.4 System memory	2-16
2.4.1 Overview	2-16
2.4.3 Memory mirroring and sparing technology.....	2-18
2.4.4 Installing a DIMM	2-21
2.4.5 Removing a DIMM	2-21
2.4.6 Installing the MemCool FB-DIMM fan (optional)	2-22
2.4.7 Uninstalling the optional MemCool FB-DIMM fan.....	2-24
2.5 Expansion slots.....	2-25
2.5.1 Installing an expansion card	2-25
2.5.2 Configuring an expansion card	2-25
2.5.3 Interrupt assignments	2-26
2.5.4 DDR2 SODIMM socket	2-26
2.5.5 PCI Express x16 slots (x16 link)	2-27
2.5.6 PCI Express x8 slot (x8 link)	2-27

Contents

- 2.5.7 PCI/PCIX slot 2-27
- 2.5.8 ZCR slot (*DSEB-DG/SAS model only*)..... 2-27
- 2.6 Jumpers 2-28**
- 2.7 Connectors 2-33**
 - 2.7.1 Rear panel connectors 2-33
 - 2.7.2 Internal connectors 2-34
- Chapter 3: Powering up**
- 3.1 Starting up for the first time 3-1**
- 3.2 Turning off the computer 3-2**
 - 3.2.1 Using the OS shut down function..... 3-2
 - 3.2.2 Using the dual function power switch..... 3-2
- Chapter 4: BIOS setup**
- 4.1 Managing and updating your BIOS 4-1**
 - 4.1.1 Creating a bootable floppy disk 4-1
 - 4.1.2 AFUDOS utility 4-2
 - 4.1.3 ASUS CrashFree BIOS 3 utility 4-5
- 4.2 BIOS setup program 4-6**
 - 4.2.1 BIOS menu screen..... 4-7
 - 4.2.2 Menu bar..... 4-7
 - 4.2.3 Navigation keys..... 4-7
 - 4.2.4 Menu items 4-8
 - 4.2.5 Sub-menu items..... 4-8
 - 4.2.6 Configuration fields 4-8
 - 4.2.7 Pop-up window 4-8
 - 4.2.8 Scroll bar..... 4-8
 - 4.2.9 General help 4-8
- 4.3 Main menu 4-9**
 - 4.3.1 System Date [Day xx/xx/xxxx]..... 4-9
 - 4.3.2 System Time [xx:xx:xx] 4-9
 - 4.3.3 Floppy A [1.44 MB 3½"]..... 4-9
 - 4.3.4 IDE Configuration..... 4-10
 - 4.3.5 Primary/Third/Fourth IDE Master/Slave 4-11
 - 4.3.6 System Information 4-12
- 4.4 Advanced menu 4-14**
 - 4.4.1 CPU Configuration 4-14
 - 4.4.2 Chipset Configuration 4-16
 - 4.4.3 PCI PnP 4-20

Contents

4.4.4	USB Configuration	4-22
4.4.5	Peripheral Configuration	4-23
4.4.6	ACPI Configuration	4-24
4.4.7	Power On Configuration.....	4-25
4.4.8	Hardware Monitor	4-26
4.5	Server menu	4-28
4.5.1	Remote Access Configuration.....	4-28
4.6	Security.....	4-30
	Change Supervisor Password.....	4-30
	Change User Password	4-31
	Password Check [Setup].....	4-31
	Password Lock Mode [Disabled].....	4-31
	Removable Device Boot [Enabled]	4-31
	Flash Write [Disabled].....	4-31
4.7	Boot menu	4-32
4.7.1	Boot Device Priority	4-32
4.7.2	Boot Settings Configuration	4-33
4.8	Exit menu.....	4-34
 Chapter 5: RAID configuration		
5.1	Setting up RAID.....	5-1
5.1.1	RAID definitions	5-1
5.1.2	Installing hard disk drives.....	5-3
5.1.3	Setting the RAID item in BIOS	5-3
5.1.4	RAID configuration utilities.....	5-3
5.2	LSI Logic Embedded SATA RAID Setup Utility.....	5-4
5.2.1	Creating a RAID 0 or RAID 1 set	5-5
5.2.2	Creating a RAID 10 set.....	5-11
5.2.3	Adding or viewing a RAID configuration	5-15
5.2.4	Initializing the logical drives	5-18
5.2.5	Rebuilding failed drives.....	5-23
5.2.6	Checking the drives for data consistency	5-25
5.2.7	Deleting a RAID configuration.....	5-28
5.2.8	Selecting the boot drive from a RAID set.....	5-29
5.2.9	Enabling the WriteCache	5-30
5.3	Intel® Matrix Storage Manager Option ROM Utility	5-31
5.3.1	Creating a RAID 0 set (Stripe)	5-32
5.3.2	Creating a RAID 1 set (Mirror)	5-34
5.3.3	Creating a RAID 10 set (Stripe + Mirror).....	5-35

Contents

- 5.3.4 Creating a RAID 5 set (Parity) 5-36
- 5.3.5 Deleting a RAID set 5-37
- 5.3.6 Resetting disks to Non-RAID 5-38
- 5.3.7 Exiting the Intel® Matrix Storage Manager 5-38
- 5.4 **Global Array Manager** **5-39**
- 5.5 **Marvell® 88SE6145 RAID BIOS configuration utility
(DSEB-DG model only)**..... **5-40**
 - 5.5.1 Creating a RAID set
(RAID 0, RAID 1, RAID 10, or RAID 5) 5-41
 - 5.5.2 Deleting an array 5-44
- 5.6 **LSI Logic MPT Setup Utility
(DSEB-DG/SAS model only)** **5-46**
 - 5.6.1 Integrated Mirroring..... 5-46
 - 5.6.2 Integrated Mirroring Enhanced 5-50
 - 5.6.3 Integrated Striping (IS) volume 5-52
 - 5.6.4 Managing Arrays 5-55
 - 5.6.5 Viewing SAS topology..... 5-60
 - 5.6.6 Global Properties 5-62
- Chapter 6: Driver installation**
- 6.1 **RAID driver installation** **6-1**
 - 6.1.1 Creating a RAID driver disk 6-1
 - 6.1.2 Installing the RAID controller driver 6-6
- 6.2 **Intel chipset software installation** **6-13**
- 6.3 **LAN driver installation**..... **6-16**
 - 6.3.1 Windows 2000/Server 2003 6-16
 - 6.3.2 Red Hat..... 6-21
- 6.4 **VGA driver installation**..... **6-22**
 - 6.4.1 Windows® 2000/Server 2003 6-22
- 6.5 **Management applications and utilities installation** **6-24**
 - 6.5.1 Running the support CD 6-24
 - 6.5.2 Drivers menu..... 6-24
 - 6.5.3 Management Software menu 6-25
 - 6.5.4 Utilities menu 6-25
 - 6.5.5 Contact information..... 6-25
- Appendix: Reference information**
- A.1 **DSEB-DG/SAS model block diagram** **A-1**
- A.2 **DSEB-DG model block diagram**..... **A-2**

Notices

Federal Communications Commission Statement

This device complies with Part 15 of the FCC Rules. Operation is subject to the following two conditions:

- This device may not cause harmful interference, and
- This device must accept any interference received including interference that may cause undesired operation.

This equipment has been tested and found to comply with the limits for a Class B digital device, pursuant to Part 15 of the FCC Rules. These limits are designed to provide reasonable protection against harmful interference in a residential installation. This equipment generates, uses and can radiate radio frequency energy and, if not installed and used in accordance with manufacturer's instructions, may cause harmful interference to radio communications. However, there is no guarantee that interference will not occur in a particular installation. If this equipment does cause harmful interference to radio or television reception, which can be determined by turning the equipment off and on, the user is encouraged to try to correct the interference by one or more of the following measures:

- Reorient or relocate the receiving antenna.
- Increase the separation between the equipment and receiver.
- Connect the equipment to an outlet on a circuit different from that to which the receiver is connected.
- Consult the dealer or an experienced radio/TV technician for help.



The use of shielded cables for connection of the monitor to the graphics card is required to assure compliance with FCC regulations. Changes or modifications to this unit not expressly approved by the party responsible for compliance could void the user's authority to operate this equipment.

Canadian Department of Communications Statement

This digital apparatus does not exceed the Class B limits for radio noise emissions from digital apparatus set out in the Radio Interference Regulations of the Canadian Department of Communications.

This class B digital apparatus complies with Canadian ICES-003.

Safety information

Electrical safety

- To prevent electrical shock hazard, disconnect the power cable from the electrical outlet before relocating the system.
- When adding or removing devices to or from the system, ensure that the power cables for the devices are unplugged before the signal cables are connected. If possible, disconnect all power cables from the existing system before you add a device.
- Before connecting or removing signal cables from the motherboard, ensure that all power cables are unplugged.
- Seek professional assistance before using an adapter or extension cord. These devices could interrupt the grounding circuit.
- Make sure that your power supply is set to the correct voltage in your area. If you are not sure about the voltage of the electrical outlet you are using, contact your local power company.
- If the power supply is broken, do not try to fix it by yourself. Contact a qualified service technician or your retailer.

Operation safety

- Before installing the motherboard and adding devices on it, carefully read all the manuals that came with the package.
- Before using the product, make sure all cables are correctly connected and the power cables are not damaged. If you detect any damage, contact your dealer immediately.
- To avoid short circuits, keep paper clips, screws, and staples away from connectors, slots, sockets and circuitry.
- Avoid dust, humidity, and temperature extremes. Do not place the product in any area where it may become wet.
- Place the product on a stable surface.
- If you encounter technical problems with the product, contact a qualified service technician or your retailer.



This symbol of the crossed out wheeled bin indicates that the product (electrical, electronic equipment, and mercury-containing button cell battery) should not be placed in municipal waste. Check local regulations for disposal of electronic products.

About this guide

This user guide contains the information you need when installing and configuring the motherboard.

How this guide is organized

This user guide contains the following parts:

- **Chapter 1: Product introduction**
This chapter describes the features of the motherboard and the new technologies it supports.
- **Chapter 2: Hardware information**
This chapter lists the hardware setup procedures that you have to perform when installing system components. It includes description of the switches, jumpers, and connectors on the motherboard.
- **Chapter 3: Powering up**
This chapter describes the power up sequence and ways of shutting down the system.
- **Chapter 4: BIOS setup**
This chapter tells how to change system settings through the BIOS Setup menus. Detailed descriptions of the BIOS parameters are also provided.
- **Chapter 5: RAID configuration**
This chapter provides instructions for setting up, creating, and configuring RAID sets using the available utilities.
- **Chapter 6: Driver installation**
This chapter provides instructions for installing the necessary drivers for different system components.
- **Appendix: Reference information**
This appendix includes additional information that you may refer to when configuring the motherboard.

Where to find more information

Refer to the following sources for additional information and for product and software updates.

1. **ASUS websites**
The ASUS website provides updated information on ASUS hardware and software products. Refer to the ASUS contact information.
2. **Optional documentation**
Your product package may include optional documentation, such as warranty flyers, that may have been added by your dealer. These documents are not part of the standard package.

Conventions used in this guide

To make sure that you perform certain tasks properly, take note of the following symbols used throughout this manual.



DANGER/WARNING: Information to prevent injury to yourself when trying to complete a task.



CAUTION: Information to prevent damage to the components when trying to complete a task.



IMPORTANT: Instructions that you **MUST** follow to complete a task.



NOTE: Tips and additional information to help you complete a task.

Typography

Bold text

Indicates a menu or an item to select.

Italics

Used to emphasize a word or a phrase.

<Key>

Keys enclosed in the less-than and greater-than sign means that you must press the enclosed key.

Example: <Enter> means that you must press the Enter or Return key.

<Key1+Key2+Key3>

If you must press two or more keys simultaneously, the key names are linked with a plus sign (+).

Example: <Ctrl+Alt+D>

Command

Means that you must type the command exactly as shown, then supply the required item or value enclosed in brackets.

Example: At the DOS prompt, type the command line: **format A:/S**

DSEB-DG Series specifications summary

Model Name		DSEB-DG/SAS	DSEB-DG
Processor / System Bus		2 * Socket LGA771	
		Dual-Core Intel® Xeon® Processor 5000/5100/5200	
		Quad-Core Intel® Xeon® Processor 5300/5400	
		Sequence	
		Dual Core/Quad Core	
Core Logic		FSB 1066/1333/1600MHz EM64T	
		2x2M, 4M & 8M L2 cache	
Form Factor		Intel® 5400 Memory Controller Hub (MCH)	
		Intel® 6321ESB I/O Controller Hub (ICH)	
Form Factor		SSI EEB 3.61, 12" x 13"	
ASUS Features	Smart Fan	Smart Fan II	
	Rack Ready (Rack and Pedestal dual use)	√	√
	ASWM2.0	√	√
Memory	Total Slots	8 (4-channel)	
	Capacity	Maximum up to 32 GB	
	Memory Type	Fully-Buffered DIMM DDR2 533/667/800 Reg. ECC	
	Memory Size	512 MB, 1 GB, 2GB, 4GB	
Expansion Slots (follow SSI Location #)	Total PCI/PCI-X/PCI-E Slots	6	6
	Slot Location 1	1 * PCI-X 100/133 MHz (support Zero Channel RAID card)	1 * PCI-X 133 MHz
	Slot Location 2	1 * PCI-X 133 MHz	
	Slot Location 3	1 * PCI-E x16	
	Slot Location 4	1 * PCI-E x8 (x8 link)	
	Slot Location 5	1 * PCI 32bit/33 MHz	
	Slot Location 6	1 * PCI-E x16	
	Additional Slot 1	1* SO-DIMM socket for optional ASMB3-SOL	
Storage	IDE Controller	Intel® 6321 ESB: 1 * Single Channel Bus Master IDE support UltraATA 33 / 66 / 100	
	SATA Controller	Intel® 6321 ESB: 6 SATA2 300MB/s ports Intel® Matrix Storage (for Windows only) (Support RAID Software 0, 1, 10 & 5)	Intel® 6321 ESB: 6 SATA2 300MB/s ports Intel® Matrix Storage (for Windows only) (Support RAID Software 0, 1, 10 & 5) LSI® MegaRAID (for Linux/Windows) (Support software RAID 0, 1 & 10) Marvell® 88SE6145 * 2 Total 8 SATA2 300MB/s ports (Support software RAID 0, 1, 10 & 5)

DSEB-DG Series specifications summary

Storage	SAS Controller	LSI 1068 PCI-X 8-port SAS controller: LSI® Integrated RAID 0, 1, 1E support Optional LSI® ZCR (Zero-Channel-RAID) PCI-X card: (For upgrade to support hardware RAID 0, 1, 10, 5, 50)	--
	Networking	LAN	Intel® 6321+ Intel® 82563EB Dual Port GbE Intel® 82573 GbE * 2
Graphic	VGA	XGI Z9s PCI Display Controller 32MB	
Onboard I/O Connectors	Floppy Connector	1	1
	PSU Connector	24-pin ATX power connector + 8-pin ATX 12V power connector + 4-pin ATX 12V power connector	
	Management Connector	SO-DIMM socket for ASMB3-SOL	
	USB Connectors	1 (support 2 USB ports)	
	Fan Header	9*4-Pin	
	SMBus	2	2
	Chassis Intruder	1	1
	Front LAN LED	2	2
	Serial Port Header	1	1
	Rear I/O Connectors	External Serial Port	1
External USB Port		2	2
VGA Port		1	1
RJ-45		4	4
RJ-45 for iKVM		1	1
PS/2 KB/Mouse		1	1
Management Solution	Software	ASWM2.0	
	Out of Band Remote Management	Optional (ASMB3-SOL/ASMB3-iKVM)	
Monitoring	CPU Temperature	√	√
	FAN RPM	√	√
Environment	Operation temperature: 10°C ~ 35°C Non operation temperature: -40°C ~ 70°C Non operation humidity: 20% ~ 90% (Non condensing)		

*Specifications are subject to change without notice.

This chapter describes the motherboard features and the new technologies it supports.

1 Product introduction

Chapter summary

1

1.1	Welcome!	1-1
1.2	Package contents.....	1-1
1.3	Special features.....	1-2

1.1 Welcome!

Thank you for buying an ASUS® DSEB-DG series motherboard!

The motherboard delivers a host of new features and latest technologies, making it another standout in the long line of ASUS quality motherboards!

Before you start installing the motherboard, and hardware devices on it, check the items in your package with the list below.

1.2 Package contents

Check your motherboard package for the following items.

		DSEB-DG/SAS Retail Pack	DSEB-DG Retail Pack	DSEB-DG Bulk Pack
Cables	SATA signal cable	14	14	--
	SATA power cable	7	7	--
	SAS cable (SFF-8087 to 4 x 29 pin SAS)	2	--	--
	2-in-1 cable set (IDE + FDD cable)	1	1	--
Accessories	IO shield	1	1	1
	CEK spring	2	2	2
Application CD	Support CD	1	1	1
Documentation	User Guide	1	1	1
Packing Qty.		3pcs per carton	3pcs per carton	10pcs per carton



If any of the above items is damaged or missing, contact your retailer.

1.3 Serial number label

Before requesting support from the ASUS Technical Support team, you must take note of the motherboard's serial number containing 12 characters **xxM0Axxxxxxx** shown as the figure below. With the correct serial number of the product, ASUS Technical Support team members can then offer a quicker and satisfying solution to your problems.



1.4 Special features

1.4.1 Product highlights

Latest processor technology



The motherboard comes with two LGA-771 sockets that support Dual-Core Intel® Xeon™ processors with 1600/1333/1066 MHz Front Side Bus (FSB). Dual-core processors contain two physical CPU cores to meet demands for more powerful processing. Intel® Xeon™ processors incorporate the Intel® Hyper-Threading Technology and Extended Memory 64-bit Technology (EM64T). The EM64T enables the support for 64-bit operation system, such as 64-bit Windows® and Linux.

Intel® 5400 and Intel® 6321ESB chipset

The Intel® 5400 Memory Controller Hub (MCH) and the Intel® 6321ESB provide the vital interfaces for the motherboard.

The MCH provides the processor, quadri-channel FB-DIMM memory support, and PCI Express interfaces. The Intel® 6321ESB is a new generation server class I/O controller hub that provides the interface for PCI 2.3, PCI Express, and PCIX.

Intel® EM64T



The motherboard supports Intel® processors with the Intel® EM64T (Extended Memory 64 Technology). The Intel® EM64T feature allows your computer to run on 64-bit operating systems and access larger amounts of system memory for faster and more efficient computing.

Enhanced Intel SpeedStep® Technology (EIST)

The Enhanced Intel SpeedStep® Technology (EIST) intelligently manages the CPU resources by automatically adjusting the CPU voltage and core frequency depending on the CPU loading and system speed or power requirement.

FB-DIMM memory support

This motherboard supports fully buffered DIMMs (FB-DIMMs), the latest memory solution that extends memory capacity and provide high-speed, high-density system memory performance. FB-DIMMs use Advanced Memory Buffer (AMB) chips that transmit signals between the memory modules and controllers with improved signal integrity and reduced errors.

PCIe 2.0



This motherboard supports the latest PCIe 2.0 device for twice the current speed and bandwidth. This enhances system performance while still providing backward compatibility to PCIe 1.0 devices.

Serial Attached SCSI (SAS) technology support

(DSEB-DG/SAS model only)

SAS is the latest storage interface for enterprise-class storage devices. Building on and improving the parallel SCSI foundation, SAS is the new industry standard that includes Serial ATA interoperability, and is projected to be the successor of the Ultra320 SCSI technology.

Zero-Channel RAID (ZCR) solution

(DSEB-DG/SAS model only)

The motherboard comes with a ZCR socket for an optional Zero-Channel RAID card, allowing RAID 0 (striping), RAID 1 (mirroring), RAID 0+1, and RAID 5 configurations. The ZCR capability provides a cost-effective high-performance and added reliability.

82563/82573 LAN solution



The motherboard comes with a dual-port 82563EB network connection and two single-port 82573 L network connection to provide a total solution for your networking needs. See page 2-33 for the location of the LAN ports. See section **2.6 Jumpers** for details on Gigabit LAN settings.

Serial ATA II technology



The motherboard supports the Serial ATA II 3 Gb/s technology through 6321ESB Serial ATA interfaces. The Serial ATA II specification provides twice the bandwidth of the current Serial ATA products with a host of new features, including Native Command Queuing (NCQ), Power Management (PM) Implementation Algorithm, and Hot Swap. Serial ATA allows thinner, more flexible cables with lower pin count and reduced voltage requirements.

USB 2.0 technology

The motherboard implements the Universal Serial Bus (USB) 2.0 specification, dramatically increasing the connection speed from the 12 Mbps bandwidth on USB 1.1 to a fast 480 Mbps on USB 2.0. USB 2.0 is backward compatible with USB 1.1.

Temperature, fan, and voltage monitoring

The CPU temperature is monitored by the W83793G chip to prevent overheating and damage. The system fan rotations per minute (RPM) is monitored for timely failure detection. The chip monitors the voltage levels to ensure stable supply of current for critical components.

Intel® IOAT2

Intel® I/O Acceleration Technology (IOAT) is an integrated server platform I/O solution that addresses all segments of the server I/O bottleneck problem using TCP/IP without requiring any modification of existing or future applications. Intel® IOAT is a system-wide solution that increases CPU efficiency and delivers data to/from applications faster than current server platforms.

High Power Efficiency

Compared with the non-green design platform, ASUS's new green motherboard design helps improve power efficiency to 90%. The motherboard, with less power consumption loss, saves you more watts and more money.

1.4.2 Innovative ASUS features

ASUS Smart Fan technology

The ASUS Smart Fan technology smartly adjusts the fan speeds according to the system loading to ensure quiet, cool, and efficient operation.

This chapter lists the hardware setup procedures that you have to perform when installing system components. It includes description of the jumpers and connectors on the motherboard.

Hardware information



2.1	Before you proceed	2-1
2.2	Motherboard overview.....	2-3
2.3	Central Processing Unit (CPU)	2-11
2.4	System memory	2-16
2.5	Expansion slots.....	2-23
2.6	Jumpers	2-26
2.7	Connectors	2-31

2.1 Before you proceed

Take note of the following precautions before you install motherboard components or change any motherboard settings.



- Unplug the power cord from the wall socket before touching any component.
- Use a grounded wrist strap or touch a safely grounded object or a metal object, such as the power supply case, before handling components to avoid damaging them due to static electricity.
- Hold components by the edges to avoid touching the ICs on them.
- Whenever you uninstall any component, place it on a grounded antistatic pad or in the bag that came with the component.
- Before you install or remove any component, ensure that the power supply is switched off or the power cord is detached from the power supply. Failure to do so may cause severe damage to the motherboard, peripherals, and/or components.

Onboard LED

1. Standby Power LED

The motherboard comes with a standby power LED. The green LED lights up to indicate that the system is ON, in sleep mode, or in soft-off mode. This is a reminder that you should shut down the system and unplug the power cable before removing or plugging in any motherboard component. The illustration below shows the location of the onboard LED

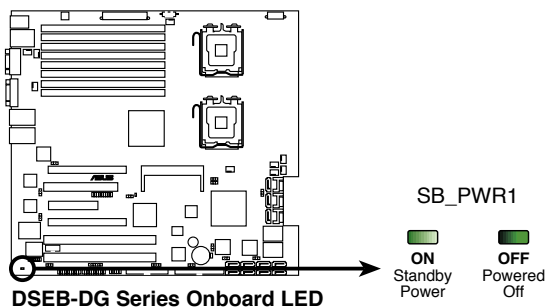

2. Heartbeat LED (for DSEB-DG/SAS only)

The green heartbeat LED blinks per second to indicate that the LSI 1068 chipset is working normally.

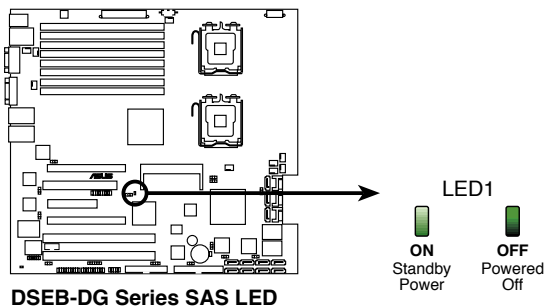

2.2 Motherboard overview

Before you install the motherboard, study the configuration of your chassis to ensure that the motherboard fits into it.

To optimize the motherboard features, we highly recommend that you install it in an SSI CEB 1.1 compliant chassis.



Make sure to unplug the chassis power cord before installing or removing the motherboard. Failure to do so can cause you physical injury and damage motherboard components!

2.2.1 Placement direction

When installing the motherboard, make sure that you place it into the chassis in the correct orientation. The edge with external ports goes to the rear part of the chassis as indicated in the image below.

2.2.2 Screw holes

Place nine (9) screws into the holes indicated by circles to secure the motherboard to the chassis.



DO NOT overtighten the screws! Doing so can damage the motherboard.

Place this side towards the rear of the chassis

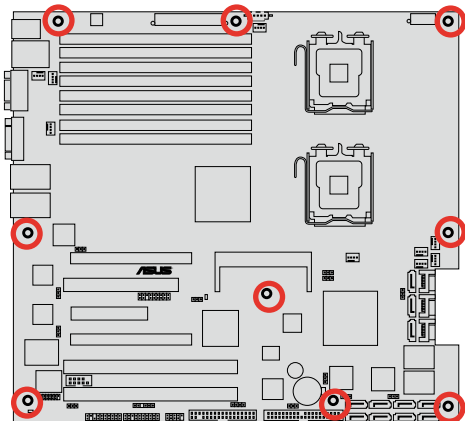

2.2.3 Support kits for the motherboard

For additional protection from motherboard breakage due to the weight of the CPU heatsinks, your motherboard package comes with CEK springs that you can use as weight support. Install the CEK springs before installing the motherboard.



We strongly recommend you use SSI CEB 1.1 compliant chassis. Otherwise, the CPU cooler cannot be mounted on the chassis.

Each CEK spring has four hooks to match the designated holes around the CPU area.

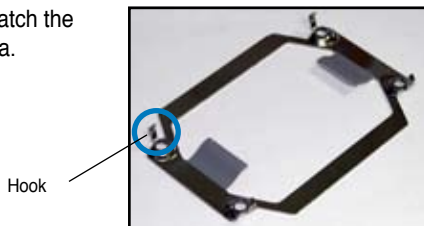

To install the CEK spring:

1. Locate the CPU heatsink holes on the motherboard.

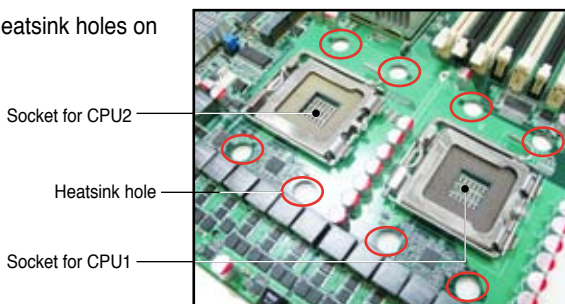

2. Position the CEK spring underneath the motherboard, then match the CEK spring hooks to the CPU1 heatsink holes.



3. Press the upper spring hooks inward, then insert to the upper CPU heatsink holes until they snap in place.

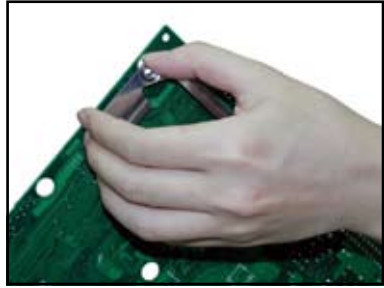

4. Press the lower spring clips inward, then insert to the lower CPU heatsink holes until they snap in place.



5. If you installed a second CPU, repeat steps 2 to 4 to install the CEK spring to the CPU2 heatsink holes. The CEK springs appear as shown when installed.

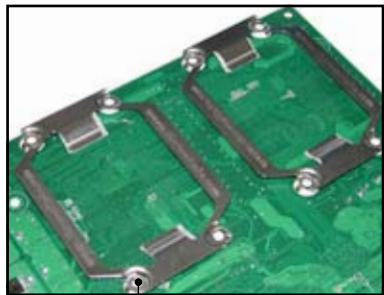

CEK spring screw hole

6. Before installing the motherboard into the chassis, locate the standoffs that should match the eight (8) CEK spring screw holes.

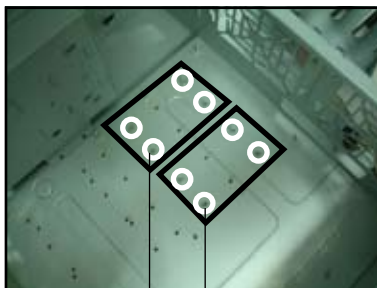

Standoffs for CPU1

Standoffs for CPU2

7. Install the motherboard with the external I/O ports toward the chassis rear panel. The CPU sockets should be right on top of their respective standoffs.



Socket for CPU2

Socket for CPU1



Make sure that the standoffs perfectly match the CEK spring screw holes; otherwise, you can not install the CPU heatsinks properly.

8. Secure the motherboard with nine (9) screws. Refer to section **2.2.2 Screw holes** for illustration.

2.2.4 Motherboard layouts

DSEB-DG/SAS model

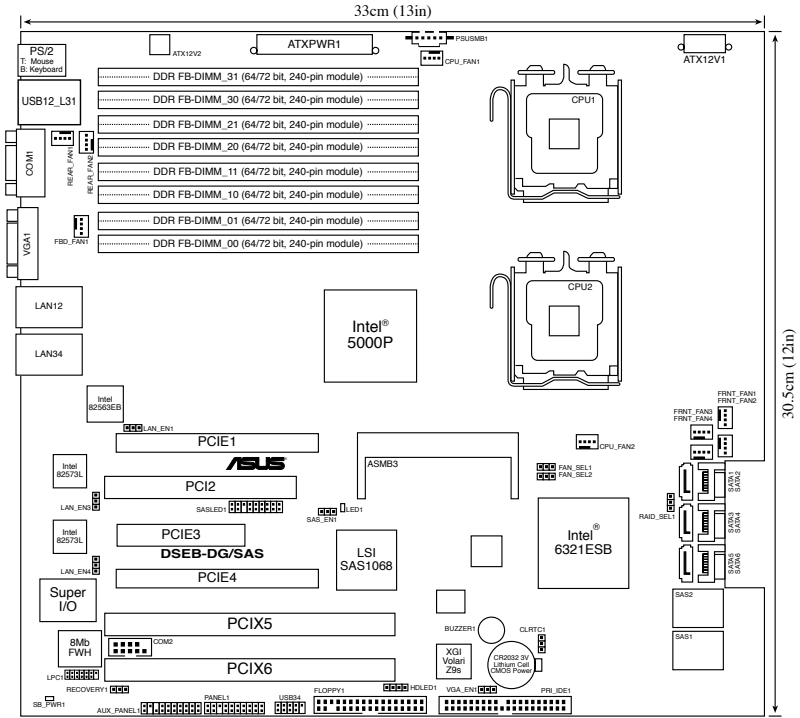

DSEB-DG model

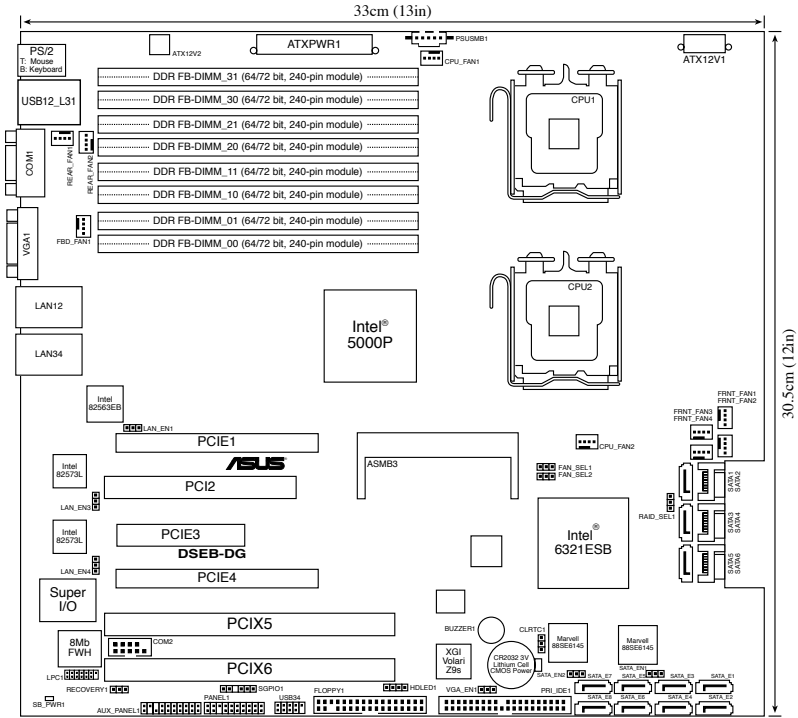

2.2.5 Layout contents

Slots/Socket		Page
1.	CPU sockets	2-11
2.	FB-DIMM sockets	2-16
3.	DDR2 SODIMM socket	2-26
4.	PCI Express x 16 slots (x16 link)	2-27
5.	PCI Express x 8 slots (x8 link)	2-27
6.	PCI/PCI-X slot	2-27
7.	ZCR slot (DSEB-DG/SAS model only)	2-27

Jumpers		Page
1.	Clear RTC RAM (CLRRTC1)	2-28
2.	VGA controller setting (3-pin VGA_EN1)	2-29
3.	LAN controller setting (3-pin LAN_EN1, LAN_EN3, LAN_EN4)	2-29
4.	Fan control setting (3-pin CPUFAN_SET1, CHAFAN_SET1)	2-30
5.	Intel® 6321ESB SATA port S/W RAID setting (3-pin RAID_SEL1) (DSEB-DG model only)	2-30
6.	Onboard storage setting (3-pin SAS_EN1) (DSEB-DG/SAS model only)	2-31
7.	Onboard SATA setting (3-pin SATA_EN1, SATA_EN2) (DSEB-DG model only)	2-31
8.	Force BIOS recovery setting (3-pin RECOVERY1)	2-32

Rear panel connectors		Page
1.	PS/2 mouse port (green)	2-33
2.	LAN port for iKVM	2-33
3.	PS/2 keyboard port (purple)	2-33
4.	USB 2.0 ports 1 and 2	2-33
5.	Serial (COM1) port	2-33
6.	Video Graphics Adapter port	2-33
7.	LAN 1/2 (RJ-45) ports	2-33
8.	LAN 3/4 (RJ-45) ports	2-33

Internal connectors		Page
1.	Floppy disk drive connector (34-1 pin FLOPPY1)	2-34
2.	IDE connector (40-1 pin PRI_IDE1)	2-34
3.	Serial ATA connectors (7-pin SATA1, SATA2, SATA3, SATA4, SATA5, SATA6)	2-35
4.	Serial ATA connectors (7-pin SATA_E1, SATA_E2, SATA_E3, SATA_E4, SATA_E5, SATA_E6, SATA_E7, SATA_E8) (DSEB-DG model only)	2-35
5.	SAS connectors (DSEB-DG/SAS model only)	2-36
6.	SAS LSI1068 ports LED connector (18-1 pin SASLED1) (DSEB-DG/SAS model only)	2-37
7.	Serial General Purpose Input/Output connector (6-1 pin SGPIO1) (DSEB-DG model only)	2-37
8.	Hard disk activity LED connector (4-pin HDLED1)	2-38
9.	USB connectors (10-1 pin USB34)	2-38
10.	CPU and system fan connectors (4-pin CPU_FAN1/2, REAR_FAN1/2, FRNT_FAN1/2/3/4)	2-39
11.	Serial port connectors (10-1 pin COM2)	2-39
12.	Power supply SMBus connector (5-pin PSUSMB1)	2-40
13.	SSI power connectors (24-pin ATXPWR1, 8-pin ATX12V1, 4-pin ATX12V2)	2-40
14.	System panel connector (20-1 pin PANEL1)	2-41
15.	Auxiliary panel connector (20-pin AUX_PANEL1)	2-42

2.3 Central Processing Unit (CPU)

The motherboard comes with a surface mount LGA771 socket designed for the Intel® Xeon® Dual/Quad Core processor.



- Your boxed Intel® Xeon® LGA771 processor package should come with installation instructions for the CPU and heatsink. If the instructions in this section do not match the CPU documentation, follow the latter.
- Upon purchase of the motherboard, make sure that the PnP cap is on the socket and the socket contacts are not bent. Contact your retailer immediately if the PnP cap is missing, or if you see any damage to the PnP cap/socket contacts/motherboard components. ASUS will shoulder the cost of repair only if the damage is shipment/transit-related.
- Keep the cap after installing the motherboard. ASUS will process Return Merchandise Authorization (RMA) requests only if the motherboard comes with the cap on the LGA771 socket.
- The product warranty does not cover damage to the socket contacts resulting from incorrect CPU installation/removal, or misplacement/loss/incorrect removal of the PnP cap.

2.3.1 Installing the CPU

To install a CPU:

1. Locate the CPU socket on the motherboard.

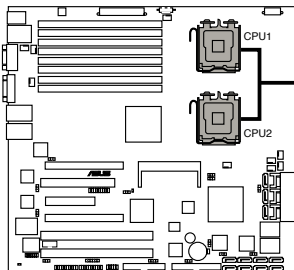

DSEB-DG Series CPU LGA771



- Before installing the CPU, make sure that the socket box is facing towards you and the load lever is on your left.
- We recommend you install the CPU to CPU2 socket for a better thermal environment when installing only one CPU.

2. Press the load lever with your thumb (A), then move it to the left (B) until it is released from the retention tab.

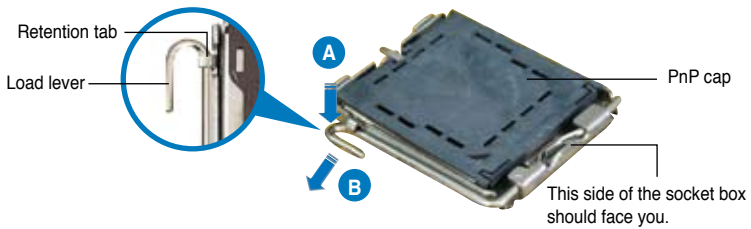

To prevent damage to the socket pins, do not remove the PnP cap unless you are installing a CPU.

3. Lift the load lever in the direction of the arrow to a 135° angle.

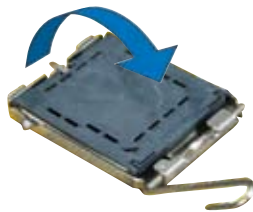

4. Lift the load plate with your thumb and forefinger to a 100° angle (A), then push the PnP cap from the load plate window to remove (B).

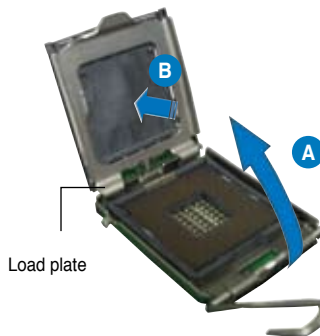

5. Position the CPU over the socket, making sure that the gold triangle is on the bottom-left corner of the socket. The socket alignment key should fit into the CPU notch.

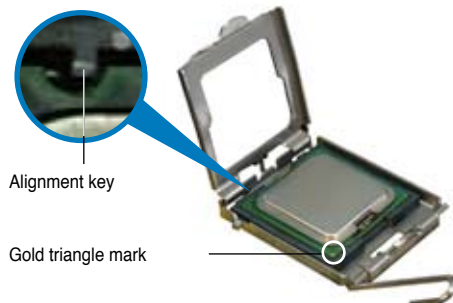

6. Close the load plate (A), then push the load lever (B) until it snaps into the retention tab.

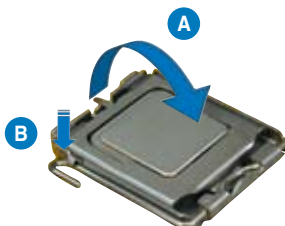

The CPU fits in only one correct orientation. DO NOT force the CPU into the socket to prevent bending the connectors on the socket and damaging the CPU!

Notes on Intel® Hyper-Threading Technology



- This motherboard supports Intel® Xeon™ CPUs in the 771-land package with Hyper-Threading Technology.
- Hyper-Threading Technology is supported by Intel® 5000 series CPU only. 5100/5200/5300/5400 series DO NOT support Hyper-Threading.
- The amount of CPU threads depends on the OS support.
- Hyper-Threading Technology is supported under Windows® XP/2003 Server and Linux 2.4.x (kernel) and later versions only. Under Linux, use the Hyper-Threading compiler to compile the code. If you are using any other operating systems, disable the Hyper-Threading Technology item in the BIOS to ensure system stability and performance.
- Installing Windows® 2003 Server or later version is recommended.
- Make sure to enable the Hyper-Threading Technology item in BIOS before installing a supported operating system.
- For more information on Hyper-Threading Technology, visit Intel® website (www.intel.com/info/hyperthreading).

To use the Hyper-Threading Technology on this motherboard:

1. Install an Intel® Xeon™ CPU that supports Hyper-Threading Technology.
2. Power up the system and enter the BIOS Setup (see Chapter 4: BIOS setup). Under the Advanced Menu, make sure that the item Hyper-Threading Technology is set to Enabled. The item appears only if you installed a CPU that supports Hyper-Threading Technology.
3. Reboot the computer.

2.3.2 Installing the CPU heatsink and fan

The Intel® Xeon™ processors require an Intel certified heatsink and fan assembly to ensure optimum thermal condition and performance.

When you buy a boxed Intel CPU, the package includes the heatsink, fan, retention brackets, screws, thermal grease, installation manual, and other items that are necessary for CPU installation.



- Make sure that you have applied the thermal grease to the top of the CPU before installing the heatsink and fan.
- Refer to the installation manual that came with the CPU package for details on heatsink/fan assembly and installation.

CPU heatsink (top view)



CPU heatsink (bottom view)

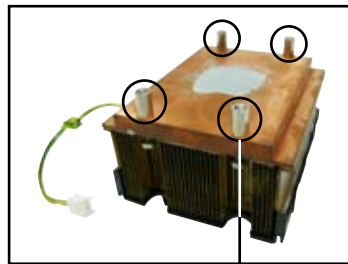

Heatsink screw

To install the CPU heatsink and fan:

1. Place the heatsink on top of the installed CPU, making sure that the four screws on the heatsink align with the nuts on the support plate.

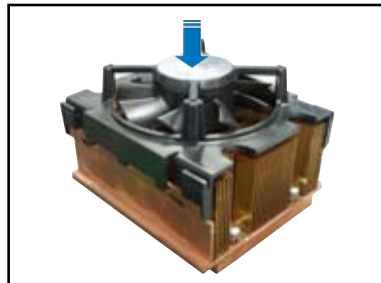

2. Use a Phillips screwdriver to tighten the four heatsink screws in a diagonal sequence.



3. Connect the fan cable to the 4-pin connector labeled CPU_FAN2.



DO NOT forget to connect the CPU fan cable! Hardware monitoring errors may occur if you fail to plug this connector.



CPU_FAN2
connector



4. Repeat steps 1 to 3 to install the other heatsink if you have installed a second CPU, then connect the fan cable to the 4-pin connector labeled CPU_FAN1.

2.4 System memory

2.4.1 Overview

The motherboard features eight fully-buffered DIMM (FB-DIMM) sockets to support 240-pin FB-DIMM modules. You can purchase extra FB-DIMM modules based on your needs. An FB-DIMM module has a different pin-out from DDR2 DIMMs so you cannot install DDR2 DIMMs on an FB-DIMM socket. Note that an FB-DIMM socket has an Advanced Memory Buffer (AMB) chip that allows memory-to-CPU connection at gigabit speed.

The figure illustrates the location of the FB-DIMM sockets:

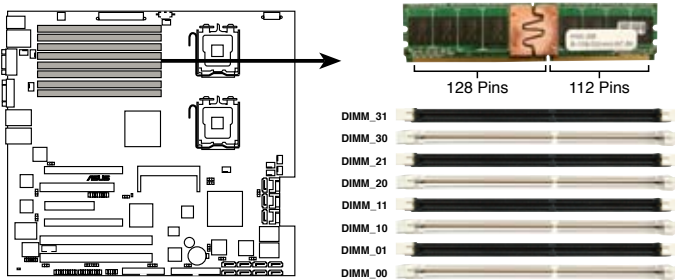

DSEB-DG Series 240-pin FB-DIMM sockets

Rank population

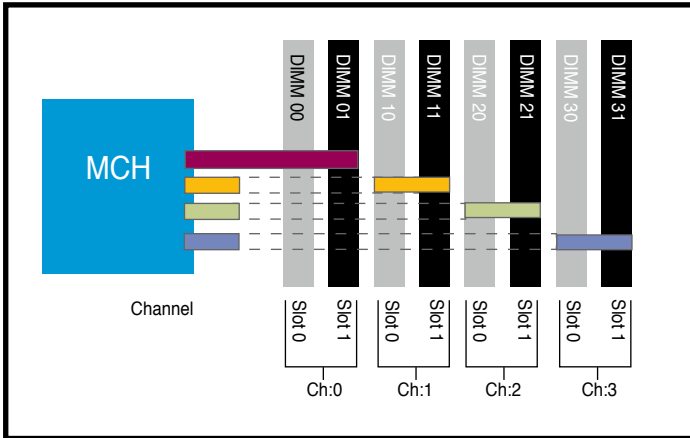

DIMM installation reference table

No. of DIMMs		Slot(s) to use	Memory architecture
1	single DIMM	DIMM_00	single channel
2	one pair	DIMM_00, DIMM_10	dual-channel
4	two pairs	(DIMM_00, DIMM_10) (DIMM_20, DIMM_30)	Quadri-channel
6	three pairs	(DIMM_00, DIMM_10) (DIMM_20, DIMM_30) (DIMM_01, DIMM_11)	Quadri-channel
8	four pairs	(DIMM_00, DIMM_10) (DIMM_20, DIMM_30) (DIMM_01, DIMM_11) (DIMM_21, DIMM_31)	Quadri-channel



DIMMs in pair means two DIMMs with the same configuration.

2.4.3 Memory mirroring and sparing technology

The Intel® 5400 chipset supports the memory mirroring and sparing technology. Refer to the below sections:

Memory Mirroring:

When enabling memory mirroring function in the BIOS setting (please refer the section **4.4.2 Chipset Configuration** and configure the option **Memory Branch Mode** as **Branch Mirroring**), Branch 1 contains a replicate copy of the data in Branch 0. The DIMMs must cover the same slot position on both branches. DIMMs that cover a slot position must be identical with respect to size, speed, and organization. DIMMs within a slot position must match each other, but aren't required to match adjacent slot positions.

And the total memories size will be the half of all installed memories.

The below two memory configurations were required to operate in mirrored mode.

1. Configuration 1 (Mirroring): **Four memories population**

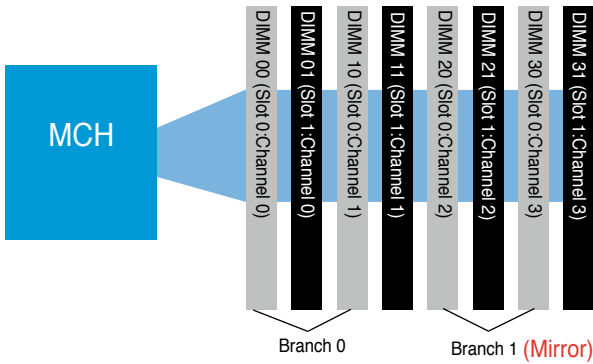

2. Configuration 2 (Mirroring) : **Eight memories population**

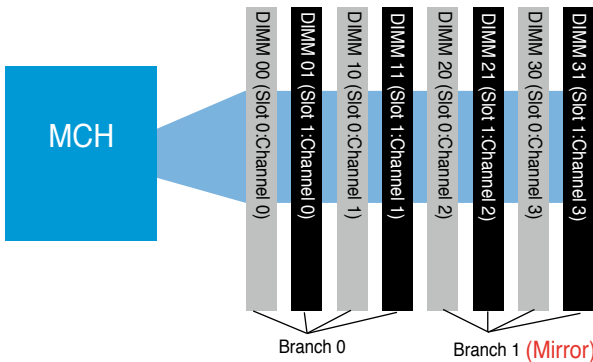

Memory Sparing :

At configuration time, a DIMM rank is set aside to replace a defective DIMM rank. When the error rate for a failing DIMM rank reaches a pre-determined threshold, the memory sparing function will issue an interrupt and initiate a spare copy. At the completion of the copy, the failing DIMM rank is disabled and the “spared” DIMM rank will be used in its place. Refer to **4.4.2 Chipset Configuration** and configure the options of **Branch Specific Sparing** to enable the memory sparing functions. And the default BIOS setting is disabled.



- Each branch contains its own sparing engine and can be enabled or disabled separately.
- This motherboard does not support rank sparing across branches.
- This motherboard does not support rank sparing when in mirror mode.
- The DIMM rank with the largest size will be assigned as spare rank. Data can only be copied from a smaller sized rank to a larger sized one.
- A DIMM can contain only one or two ranks. To support sparing function, a DIMM channel should contain at least two ranks.
- When sparing function is enabled, the usable memory size will reduce then size of the spare ranks.

The following tables show memory configurations with Memory Sparing function in Branch 0.

One DIMM per channel (two ranks)

Branch0		Channel 0		Channel 1	
		DIMM_00 (1024MB*2 Ranks)		DIMM_10 (1024MB*2 Ranks)	
		Rank 0 (1024 MB)	Rank 1 (1024 MB)	Rank 0 (1024 MB)	Rank 1 (1024 MB)
	Sparing		●		●
	Memory space	1024 MB		1024 MB	
	Total Memory	2048 MB			

Two DIMM per channel (two ranks)

		Channel 0		Channel 1		
		DIMM_00 (512MB*2 Ranks)		DIMM_10 (512MB*2 Ranks)		
Branch0		Rank 0 (512 MB)	Rank 1 (512 MB)	Rank 0 (512 MB)	Rank 1 (512 MB)	
	Sparing					
	Memory space	1024 MB		1024 MB		
		DIMM_01 (1024MB*2 Ranks)		DIMM_11 (1024MB*2 Ranks)		
		Rank 0 (1024 MB)	Rank 1 (1024 MB)	Rank 0 (1024 MB)	Rank 1 (1024 MB)	
	Sparing		●		●	
	Memory space	1024 MB		1024 MB		
	Total Memory	4096 MB				

2.4.4 Installing a DIMM



Make sure to unplug the power supply before adding or removing DIMMs or other system components. Failure to do so may cause severe damage to both the motherboard and the components.

To install a DIMM:

1. Unlock a DIMM socket by pressing the retaining clips outward.
2. Align a DIMM on the socket such that the notch on the DIMM matches the break on the socket.
3. Firmly insert the DIMM into the socket until the retaining clips snap back in place and the DIMM is properly seated.

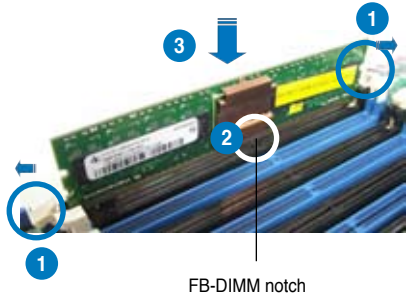

- A FB-DIMM is keyed with a notch so that it fits in only one direction. DO NOT force a DIMM into a socket to avoid damaging the DIMM.
- The FB-DIMM sockets do not support DDR2 DIMMs. DO NOT install DDR2 DIMMs to the FB-DIMM sockets.

2.4.5 Removing a DIMM

To remove a DIMM:

1. Simultaneously press the retaining clips outward to unlock the DIMM.



Support the DIMM lightly with your fingers when pressing the retaining clips. The DIMM might get damaged when it flips out with extra force.

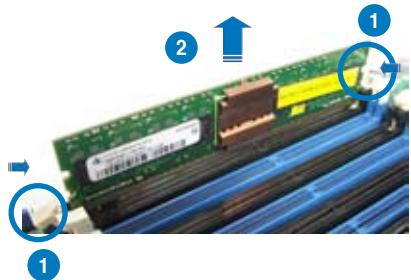

2. Remove the DIMM from the socket.

2.4.6 Installing the MemCool FB-DIMM fan (optional)

The FB-DIMMs generate heat during continued operation. To ensure optimum thermal condition and performance, install the optional MemCool FB-DIMM fan.

To install the optional FB-DIMM fan:

1. Locate the three FB-DIMM fan holes on the motherboard.

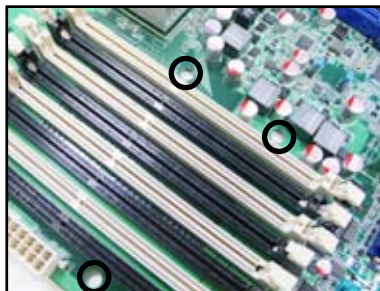

2. Disengage the fan top cover from the fan base. You can do this by firmly gripping the top cover by the clamps to release the hooks, then pull up the top cover carefully until it separates from the fan base.



DO NOT remove the fan from the fan base.

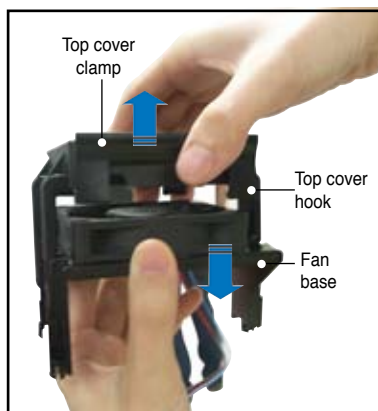

3. Position the fan base over the DIMMs, and insert the fan base legs into the FB-DIMM holes until the legs are securely in place.



For instructional purposes only, no FB-DIMM is installed on any of the slots.

4. Position top cover over the fan base. Insert the top cover legs into the slot on the fan base legs. Push down carefully until the legs are securely in place and the top cover hooks snap in place.

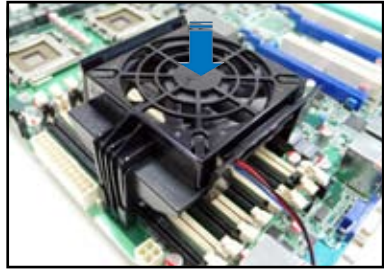

Make sure the cables pass through the notch on the fan base as shown.



5. Connect the fan cable to the 4-pin connector labeled FBD_FAN1.

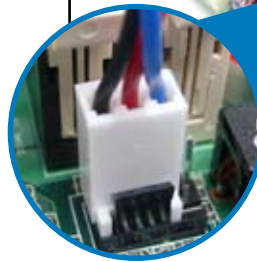
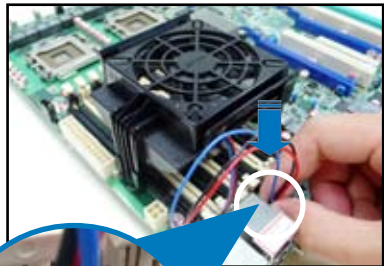

2.4.7 Uninstalling the optional MemCool FB-DIMM fan

1. Unplug the fan cable.



2. Grip the top cover clamps until the top cover hooks are released, then carefully lift the top cover while supporting the fan base with your free hand.

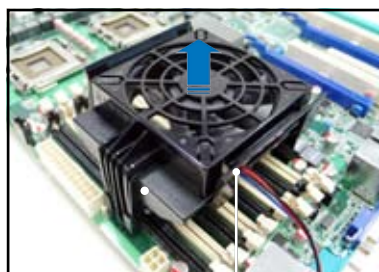

Top cover clamp

3. Carefully lift the fan base.



2.5 Expansion slots

In the future, you may need to install expansion cards. The following sub-sections describe the slots and the expansion cards that they support.



Make sure to unplug the power cord before adding or removing expansion cards. Failure to do so may cause you physical injury and damage motherboard components.

2.5.1 Installing an expansion card

To install an expansion card:

1. Before installing the expansion card, read the documentation that came with it and make the necessary hardware settings for the card.
2. Remove the system unit cover (if your motherboard is already installed in a chassis).
3. Remove the bracket opposite the slot that you intend to use. Keep the screw for later use.
4. Align the card connector with the slot and press firmly until the card is completely seated on the slot.
5. Secure the card to the chassis with the screw you removed earlier.
6. Replace the system cover.

2.5.2 Configuring an expansion card

After installing the expansion card, configure it by adjusting the software settings.

1. Turn on the system and change the necessary BIOS settings, if any. See Chapter 4 for information on BIOS setup.
2. Assign an IRQ to the card. Refer to the tables on the next page.
3. Install the software drivers for the expansion card.



When using PCI cards on shared slots, ensure that the drivers support "Share IRQ" or that the cards do not need IRQ assignments. Otherwise, conflicts will arise between the two PCI groups, making the system unstable and the card inoperable.

2.5.3 Interrupt assignments

Standard Interrupt assignments

IRQ	Priority	Standard function
0	1	System Timer
1	2	Keyboard Controller
2	-	Programmable Interrupt
3*	11	Communications Port (COM2)
4*	12	Communications Port (COM1)
5*	13	--
6	14	Floppy Disk Controller
7*	15	--
8	3	System CMOS/Real Time Clock
9*	4	ACPI Mode when used
10*	5	IRQ Holder for PCI Steering
11*	6	IRQ Holder for PCI Steering
12*	7	PS/2 Compatible Mouse Port
13	8	Numeric Data Processor
14*	9	Primary IDE Channel
15*	10	Secondary IDE Channel

* These IRQs are usually available for ISA or PCI devices.

2.5.4 DDR2 SODIMM socket

The DDR2 SODIMM socket on the motherboard supports an ASUS® Server Management Board 3 Series (ASMB3).

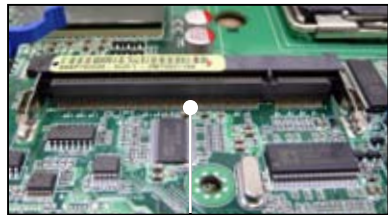

SODIMM socket

2.5.5 PCI Express x16 slots (x16 link)

The onboard PCI Express x16 slots provides x16 link to the ESB2. These slots, which support the latest PCIe 2.0 device for twice the current speed and bandwidth, are designed for various server class high performance add-on cards

2.5.6 PCI Express x8 slot (x8 link)

The onboard PCI Express x8 slot provides x8 link to the ESB2. These slots are designed for various server class high performance add-on cards like SCSI RAID card, fiber-channel card, etc.

2.5.7 PCI/PCIX slot

The PCI/PCI-X slots support cards such as a LAN card, SCSI card, USB card, and other cards that comply with PCI 2.3 and PCI-X 1.0 specifications.

2.5.8 ZCR slot (DSEB-DG/SAS model only)

The 64bit PCI-X slot (green) on the motherboard supports a Zero-Channel RAID card that allows RAID0, RAID1, RAID10 and RAID 5 configurations.



- When installing an optional ZCR card, install the card on PCIX5 slot (colored green on DSEB-DG/SAS model).
- The optional ZCR card for DSEB-DG/SAS onboard LSI 1068 SAS controller is LSI MegaRAID SAS 8300XLP card. Visit the LSI LOGIC website (www.lsillogic.com) for more information.

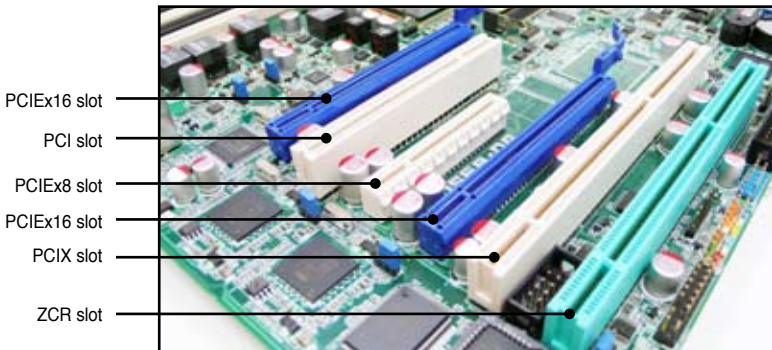

2.6 Jumpers

1. Clear RTC RAM (CLRRTC1)

This jumper allows you to clear the Real Time Clock (RTC) RAM in CMOS. You can clear the CMOS memory of date, time, and system setup parameters by erasing the CMOS RTC RAM data. The onboard button cell battery powers the RAM data in CMOS, which include system setup information such as system passwords.

To erase the RTC RAM:

1. Turn OFF the computer and unplug the power cord.
2. Move the jumper cap from pins 1-2 (default) to pins 2-3. Keep the cap on pins 2-3 for about 5~10 seconds, then move the cap back to pins 1-2.
3. Plug the power cord and turn ON the computer.
4. Hold down the key during the boot process and enter BIOS setup to re-enter data.



Except when clearing the RTC RAM, never remove the cap on CLRRTC jumper default position. Removing the cap will cause system boot failure!



If the steps above do not help, remove the onboard battery and move the jumper again to clear the CMOS RTC RAM data. After the CMOS clearance, reinstall the battery.

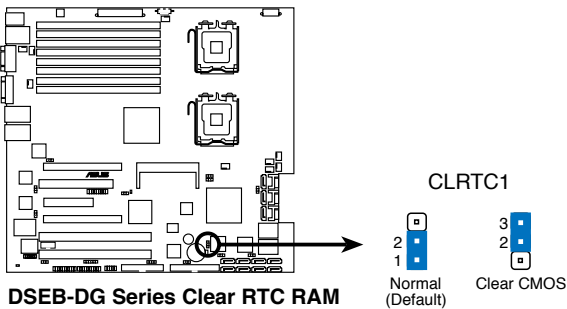

2. VGA controller setting (3-pin VGA_EN1)

This jumper allows you to enable or disable the onboard VGA controller. Set to pins 1-2 to activate the VGA feature.

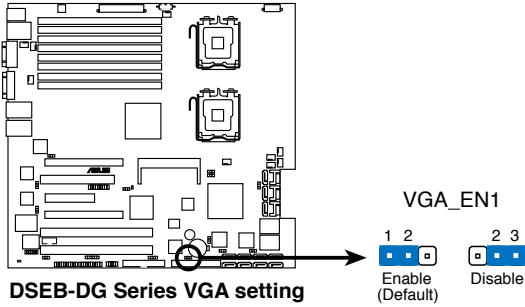

3. LAN controller setting (3-pin LAN_EN1, LAN_EN3, LAN_EN4)

These jumpers allow you to enable or disable the onboard Intel® 82563EB Gigabit LAN controller and the onboard Intel® 82573L Gigabit LAN controllers. Set to pins 1-2 to activate the Gigabit LAN feature.

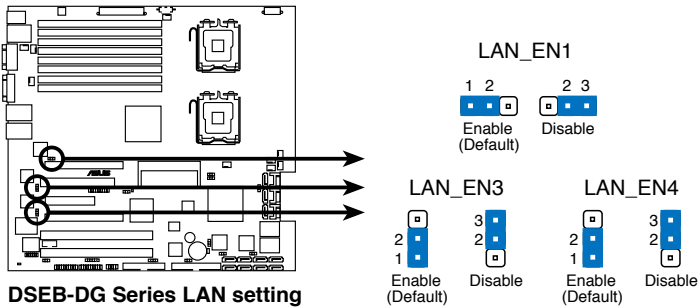

4. Fan control setting (3-pin CPUFAN_SET1, CHAFAN_SET1)

These jumpers allow you to switch for fan pin selection. The CPUFAN_SET1 jumper is for the CPU fans control and CHAFAN_SET1 is for the other fans control including front fans, rear fans and FB-DIMM fans. Set to pins 1-2 for 4-pin fans or pins 2-3 for 3-pin fans.

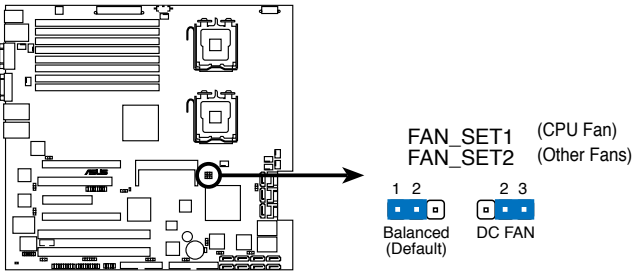

DSEB-DG Series FAN setting



- If you use a 4-pin fan but set the jumper to pin 2-3, the fan you installed may not work.
- If you use a 3-pin fan but set the jumper for a 4-pin fan, the fan control will not work and the fan you installed will always run at full speed.

5. Intel® 6321ESB SATA port S/W RAID setting (3-pin RAID_SEL1) (DSEB-DG model only)

This jumper allows you to select the Serial ATA RAID configuration utility to use when you create disk arrays. Both utilities are supported by the Intel® 6321ESB. Place the jumper caps on pins 1-2 if you want to use the LSI MegaRAID Serial ATA RAID utility (default); otherwise, place the jumper caps on pins 2-3 to use the Intel® Matrix Storage Manager (IMSM).

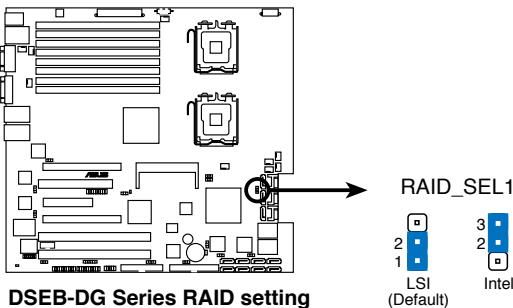

DSEB-DG Series RAID setting

6. Onboard storage setting (3-pin SAS_EN1) (DSEB-DG/SAS model only)

This jumper allows you to enable or disable the onboard LSI1068 SAS controller. Set the jumper to pins 1-2 to enable the SAS function (default).

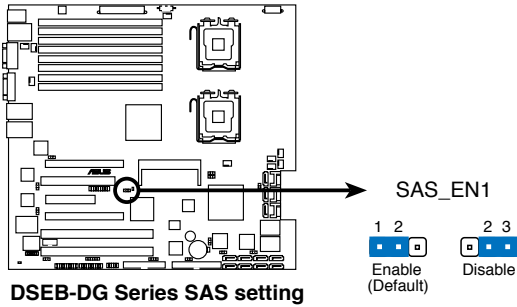

7. Onboard SATA setting (3-pin SATA_EN1, SATA_EN2) (DSEB-DG model only)

This jumper allows you to enable or disable two onboard Marvell® 6145 SATA controller. Set the jumper to pins 1-2 to enable the SATA function (default).

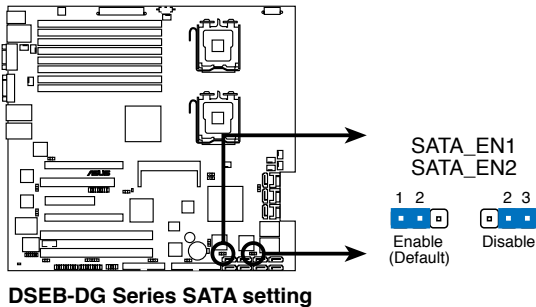

8. Force BIOS recovery setting (3-pin RECOVERY1)

This jumper allows you to quickly update or recover the BIOS settings when it becomes corrupted.

To update the BIOS:

1. Prepare a floppy disk that contains the original or latest BIOS for the motherboard (DSEB-DG.ROM) and the AFUDOS.EXE utility.
2. Set the jumper to pins 2-3.
3. Insert the floppy disk then turn on the system to update the BIOS.
4. Shut down the system.
5. Set the jumper back to pins 1-2.
6. Turn on the system.

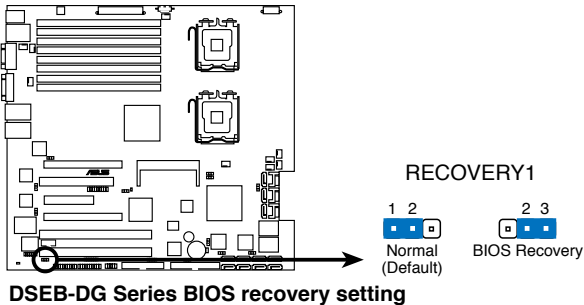

2.7 Connectors

2.7.1 Rear panel connectors

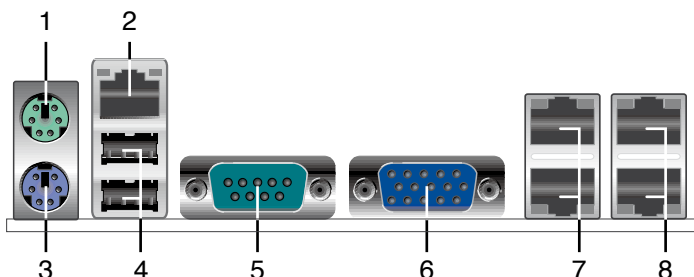

1. **PS/2 mouse port (green).** This port is for a PS/2 mouse.
2. **RJ-45 port for iKVM.** This RJ-45 port functions only when you install ASMB3 iKVM management card.
3. **PS/2 keyboard port (purple).** This port is for a PS/2 keyboard.
4. **USB 2.0 ports 1 and 2.** These two 4-pin Universal Serial Bus (USB) ports are available for connecting USB 2.0 devices.
5. **Serial (COM1) port.** This 9-pin communication port is for pointing devices or other serial devices.
6. **Video Graphics Adapter port.** This port is for a VGA monitor or other VGA-compatible devices.
7. **LAN 1/2 (RJ-45) ports.** These ports allow Gigabit connection to a Local Area Network (LAN) through a network hub. Refer to the table below for the LAN port LED indications.
8. **LAN 3/4 (RJ-45) ports.** These ports allow Gigabit connection to a Local Area Network (LAN) through a network hub. Refer to the table below for the LAN port LED indications.

LAN port LED indications

Activity/Link LED		Speed LED	
Status	Description	Status	Description
OFF	No link	OFF	10 Mbps connection
ORANGE	Linked	ORANGE	100 Mbps connection
BLINKING	Data activity	GREEN	1 Gbps connection

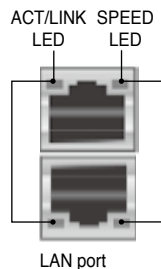

2.7.2 Internal connectors

1. Floppy disk drive connector (34-1 pin FLOPPY1)

This connector is for the provided floppy disk drive (FDD) signal cable. Insert one end of the cable to this connector, then connect the other end to the signal connector at the back of the floppy disk drive.



Pin 5 on the connector is removed to prevent incorrect cable connection when using a FDD cable with a covered Pin 5.

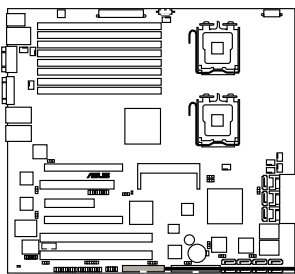

FLOPPY1

NOTE: Orient the red markings or the floppy ribbon cable to PIN 1.

DSEB-DG Series Floppy disk drive connector

2. IDE connector (40-1 pin PRI_IDE1)

This connector is for an Ultra DMA 100/66 signal cable. The Ultra DMA 100/66 signal cable has three connectors: a blue connector for the primary IDE connector on the motherboard, a black connector for an Ultra DMA 100/66 IDE slave device (optical drive/hard disk drive), and a gray connector for an Ultra DMA 100/66 IDE master device (hard disk drive). If you install two hard disk drives, you must configure the second drive as a slave device by setting its jumper accordingly. Refer to the hard disk documentation for the jumper settings.



- Pin 20 on the IDE connector is removed to match the covered hole on the Ultra DMA cable connector. This prevents incorrect insertion when you connect the IDE cable.
- Use the 80-conductor IDE cable for Ultra DMA 100/66 IDE devices.

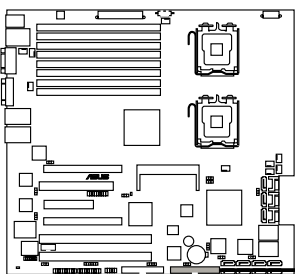

PRI_IDE1

DSEB-DG Series IDE connector

**3. Serial ATA connectors
(7-pin SATA1, SATA2, SATA3, SATA4, SATA5, SATA6)**

These connectors, controlled by southbridge ESB2, are for the Serial ATA signal cables for Serial ATA hard disk drives.

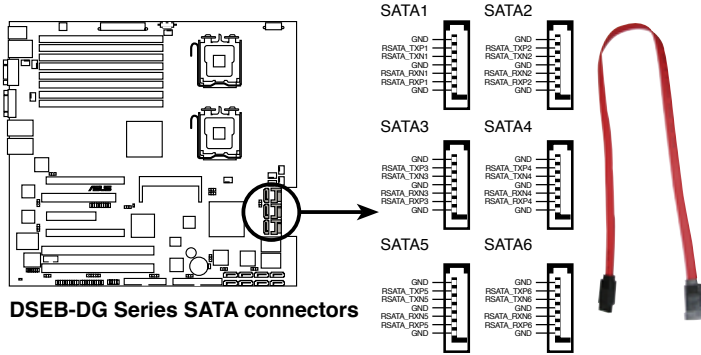

**4. Serial ATA connectors
(7-pin SATA_E1, SATA_E2, SATA_E3, SATA_E4, SATA_E5, SATA_E6, SATA_E7, SATA_E8) (DSEB-DG model only)**

These connectors, controlled by two Marvell® 6145 chipsets, are for the Serial ATA signal cables for Serial ATA hard disk drives.

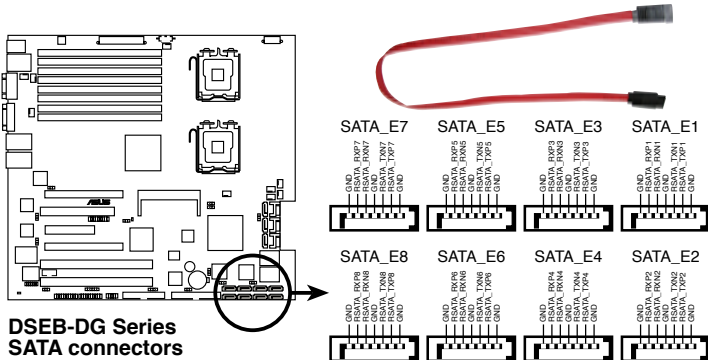

Marvell® 6145 SATA controller.	
Controller	Description
SATA controller 1	Controls SATA_E1, SATA_E2, SATA_E3, SATA_E4
SATA controller 2	Controls SATA_E5, SATA_E6, SATA_E7, SATA_E8

5. SAS connectors (DSEB-DG/SAS model only)

This motherboard comes with two Serial Attached SCSI (SAS) connectors, the next-generation storage technology that supports both Series SCSI and Serial ATA (SATA). Each connector supports one device.

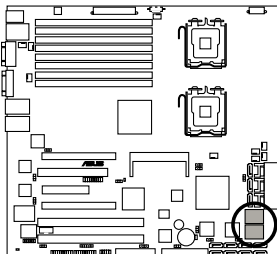

DSEB-DG Series MINI SAS connectors

To connect the SAS cable:

Plug in the SAS cable to the SAS connector until the cable lock snaps in place.



To disconnect the SAS cable:

1. With your thumb, push down the cable lock to release.
2. While still keeping your thumb's grip on the cable lock, carefully pull away the cable from the connector.

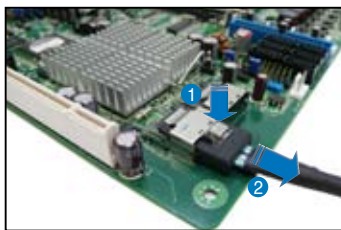

6. SAS LSI1068 ports LED connector (18-1 pin SASLED1)
(DSEB-DG/SAS model only)

This connector is for the front panel LED port indicator that shows the SAS HDD status.

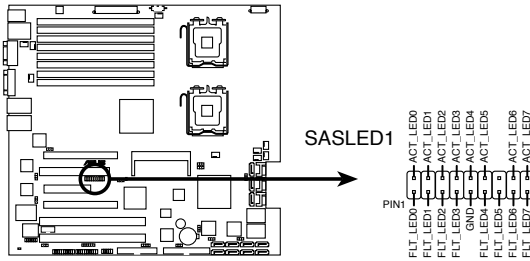

DSEB-DG Series SASLED connector

7. Serial General Purpose Input/Output connector (6-1 pin SGPIO1)
(DSEB-DG model only)

This connector is used for the SGPIO peripherals for the LSI MegaRAID SATA LED.

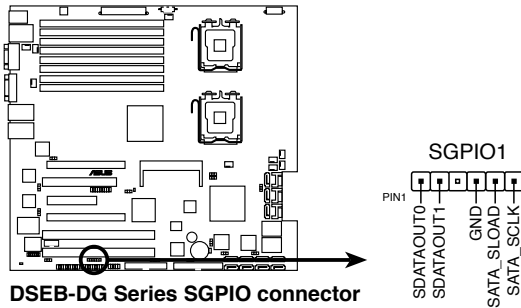

DSEB-DG Series SGPIO connector

8. Hard disk activity LED connector (4-pin HDLED1)

This connector is used to connect to a hard disk drive active LED connector on the SCSI or RAID card.

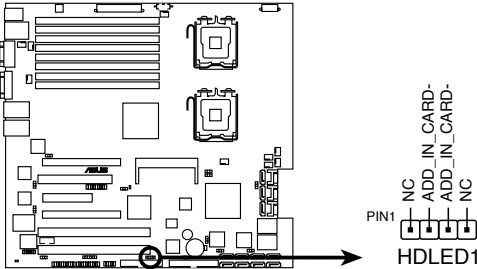

DSEB-DG Series storage card activity LED connector

9. USB connector (10-1 pin USB34)

This connector is for USB 2.0 ports. Connect the USB module cable to this connector, then install the module to a slot opening at the back of the system chassis. This USB connector complies with USB 2.0 specification that supports up to 480 Mbps connection speed.

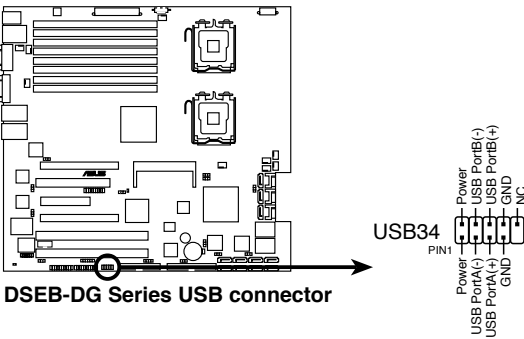

DSEB-DG Series USB connector



The USB port module is purchased separately.

10. CPU and system fan connectors (4-pin CPU_FAN1/2, REAR_FAN1/2, FRNT_FAN1/2/3/4)

The fan connectors support cooling fans of 350 mA ~ 740 mA (8.88 W max.) or a total of 3.15 A ~ 6.66 A (53.28 W max.) at +12V. Connect the fan cables to the fan connectors on the motherboard, making sure that the black wire of each cable matches the ground pin of the connector.



DO NOT forget to connect the fan cables to the fan connectors. Insufficient air flow inside the system may damage the motherboard components. These are not jumpers! DO NOT place jumper caps on the fan connectors!

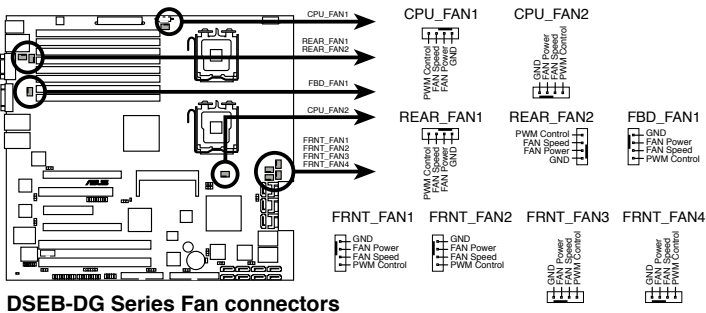

11. Serial port connector (10-1 pin COM2)

This connector is for a serial (COM) port. Connect the serial port module cable to this connector, then install the module to a slot opening at the back of the system chassis.

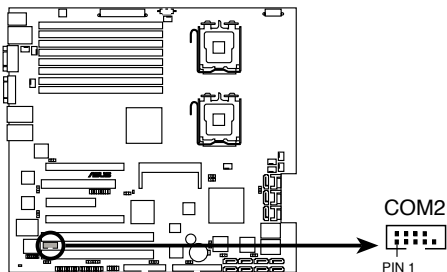

The serial port module is purchased separately.

12. Power supply SMBus connector (5-pin PSUSMB1)

This connector is for the power supply SMB cable, if your power supply supports the SMBus function.

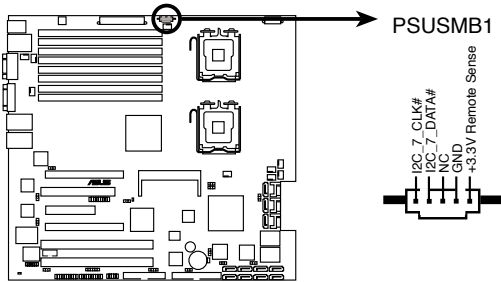

DSEB-DG Series Power supply SMBus connector

13. SSI power connectors (24-pin ATXPWR1, 8-pin ATX12V1, 4-pin ATX12V2)

These connectors are for SSI power supply plugs. The power supply plugs are designed to fit these connectors in only one orientation. Find the proper orientation and push down firmly until the connectors completely fit.



- For a fully configured system, we recommend that you use an SSI 12 V-compliant power supply unit (PSU) for LGA771-socket Intel® Xeon Dual Core processors (Bensley platform).
- DO NOT forget to connect the 24+8+4-pin power plugs; otherwise, the system will not boot up.
- Use of a PSU with a higher power output is recommended when configuring a system with more power consuming devices. The system may become unstable or may not boot up if the power is inadequate.
- You must install a PSU with a higher power rating if you intend to install additional devices.

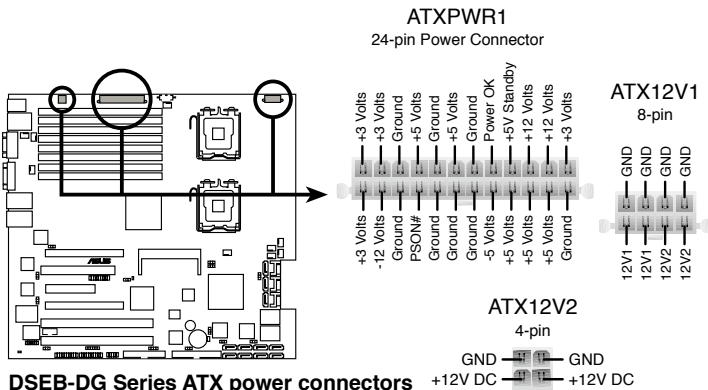

DSEB-DG Series ATX power connectors

14. System panel connector (20-pin PANEL1)

This connector supports several chassis-mounted functions.



The system panel connector is color-coded for easy connection.

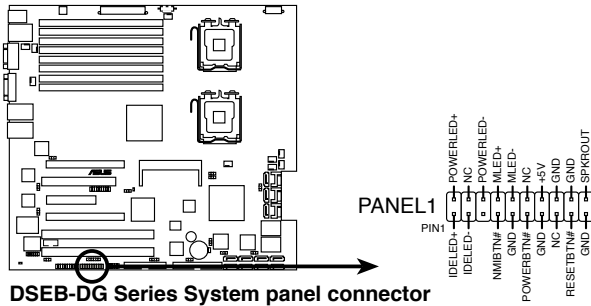

1. System power LED (Green 3-pin PLED)

This 3-pin connector is for the system power LED. Connect the chassis power LED cable to this connector. The system power LED lights up when you turn on the system power, and blinks when the system is in sleep mode.

2. Message LED (Brown 2-pin MLED)

This 2-pin connector is for the message LED cable that connects to the front message LED. The message LED is controlled by Hardware monitor to indicate an abnormal event occurrence.

3. System warning speaker (Orange 4-pin SPEAKER)

This 4-pin connector is for the chassis-mounted system warning speaker. The speaker allows you to hear system beeps and warnings.

4. Hard disk drive activity LED (Red 2-pin IDE_LED)

This 2-pin connector is for the HDD Activity LED. Connect the HDD Activity LED cable to this connector. The IDE LED lights up or flashes when data is read from or written to the HDD.

5. ATX power button/soft-off button (Green 2-pin PWRSW)

This connector is for the system power button. Pressing the power button turns the system on or puts the system in sleep or soft-off mode depending on the BIOS settings. Pressing the power switch for more than four seconds while the system is ON turns the system OFF.

6. Reset button (Blue 2-pin RESET)

This 2-pin connector is for the chassis-mounted reset button for system reboot without turning off the system power.

15. Auxiliary panel connector (20-pin AUX_PANEL1)

This connector is for additional front panel features including front panel SMB, locator LED and switch, chassis intrusion, and LAN LEDs.

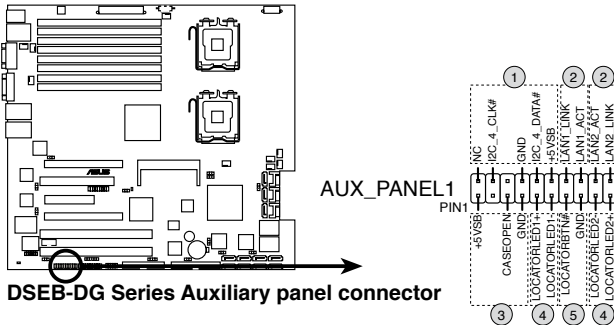

D5EB-DG Series Auxiliary panel connector

- 1. Front panel SMB (6-1 pin FPSMB)**
These leads connect the front panel SMBus cable.
- 2. LAN activity LED (2-pin LAN1_LED, LAN2_LED)**
These leads are for Gigabit LAN activity LEDs on the front panel.
- 3. Chassis intrusion (4-1 pin CHASSIS)**
These leads are for the intrusion detection feature for chassis with intrusion sensor or microswitch. When you remove any chassis component, the sensor triggers and sends a high-level signal to these leads to record a chassis intrusion event. The default setting is short CASEOPEN and GND pin by jumper cap to disable the function.
- 4. Locator LED (2-pin LOCATORLED1 and 2-pin LOCATORLED2)**
These leads are for the locator LED1 and LED2 on the front panel. Connect the Locator LED cables to these 2-pin connector. The LEDs will light up when the Locator button is pressed.
- 5. Locator Button/Switch (2-pin LOCATORBTN)**
These leads are for the locator button on the front panel. This button queries the state of the system locator.

This chapter describes the power up sequence, and ways of shutting down the system.

Powering up **3**

Chapter summary

3

3.1	Starting up for the first time.....	3-1
3.2	Turning off the computer.....	3-2

3.1 Starting up for the first time

1. After making all the connections, replace the system case cover.
2. Be sure that all switches are off.
3. Connect the power cord to the power connector at the back of the system chassis.
4. Connect the power cord to a power outlet that is equipped with a surge protector.
5. Turn on the devices in the following order:
 - a. Monitor
 - b. System power
6. After applying power, the system power LED on the system front panel case lights up. For systems with ATX power supplies, the system LED lights up when you press the ATX power button. If your monitor complies with “green” standards or if it has a “power standby” feature, the monitor LED may light up or switch between orange and green after the system LED turns on.

The system then runs the power-on self tests or POST. While the tests are running, the BIOS beeps (see BIOS beep codes table below) or additional messages appear on the screen. If you do not see anything within 30 seconds from the time you turned on the power, the system may have failed a power-on test. Check the jumper settings and connections or call your retailer for assistance.

Phoenix BIOS beep codes

Beep Description	Error
Endless beep	Memory module missing
One continuous beep followed by two short beeps	VGA controller failure
Two short beeps	PCI resource assignment error

7. At power on, hold down the <Delete> key to enter the BIOS Setup. Follow the instructions in Chapter 4.

3.2 Turning off the computer

3.2.1 Using the OS shut down function

If you are using Windows® 2000/2003:

1. Click the **Start** button then click **Shut Down**...
2. Make sure that the **Shut Down** option button is selected, then click the **OK** button to shut down the computer.
3. The power supply should turn off after Windows® shuts down.

If you are using Windows® XP:

1. Click the **Start** button then select **Turn Off Computer**.
2. Click the **Turn Off** button to shut down the computer.
3. The power supply should turn off after Windows® shuts down.

3.2.2 Using the dual function power switch

While the system is ON, pressing the power switch for less than four seconds puts the system to sleep mode or to soft-off mode, depending on the BIOS setting. Pressing the power switch for more than four seconds lets the system enter the soft-off mode regardless of the BIOS setting.

This chapter tells how to change the system settings through the BIOS Setup menus. Detailed descriptions of the BIOS parameters are also provided.

BIOS setup 4

4.1	Managing and updating your BIOS	4-1
4.2	BIOS setup program	4-6
4.3	Main menu	4-10
4.4	Advanced menu	4-16
4.5	Server menu	4-31
4.6	Security menu	4-34
4.7	Boot menu	4-36
4.8	Exit menu	4-38

4.1 Managing and updating your BIOS

The following utilities allow you to manage and update the motherboard Basic Input/Output System (BIOS) setup:

1. **ASUS AFUDOS** (Updates the BIOS in DOS mode using a bootable floppy disk.)
2. **ASUS CrashFree BIOS 3** (To recover the BIOS using a bootable floppy disk when the BIOS file fails or gets corrupted.)

Refer to the corresponding sections for details on these utilities.



Save a copy of the original motherboard BIOS file to a bootable floppy disk in case you need to restore the BIOS in the future. Copy the original motherboard BIOS using the ASUS Update or AFUDOS utilities.

4.1.1 Creating a bootable floppy disk

1. Do either one of the following to create a bootable floppy disk.

DOS environment

- a. Insert a 1.44MB floppy disk into the drive.
- b. At the DOS prompt, type **format A: /S** then press <Enter>.

Windows® XP/2003 environment

- a. Insert a 1.44 MB floppy disk to the floppy disk drive.
- b. Click **Start** from the Windows® desktop, then select **My Computer**.
- c. Select the **3 ½ Floppy Drive** icon.
- d. Right click **File** from the menu, then select **Format. A Format 3½ Floppy Disk** window appears.
- e. Select **Create an MS-DOS startup disk** from the format options field, then click **Start**.

4.1.2 AFUDOS utility

The AFUDOS utility allows you to update the BIOS file in DOS environment using a bootable floppy disk with the updated BIOS file. This utility also allows you to copy the current BIOS file that you can use as backup when the BIOS fails or gets corrupted during the updating process.

Copying the current BIOS

To copy the current BIOS file using the AFUDOS utility:



- Make sure that the floppy disk is not write-protected and has at least 1024 KB free space to save the file.
- The succeeding BIOS screens are for reference only. The actual BIOS screen displays may not be the same as shown.

1. Copy the AFUDOS utility (afudos.exe) from the motherboard support CD to the bootable floppy disk you created earlier.
2. Boot the system in DOS mode, then at the prompt type:

```
afudos /o[filename]
```

where the [filename] is any user-assigned filename not more than eight alphanumeric characters for the main filename and three alphanumeric characters for the extension name.

```
A:\>afudos /oOLDBIOS1.rom
```

Main filename Extension name

3. Press <Enter>. The utility copies the current BIOS file to the floppy disk.

```
A:\>afudos /oOLDBIOS1.rom
AMI Firmware Update Utility - Version 1.19(ASUS V2.07(03.11.24BB))
Copyright (C) 2002 American Megatrends, Inc. All rights reserved.
  Reading flash ..... done
  Write to file..... ok
A:\>
```

The utility returns to the DOS prompt after copying the current BIOS file.

Updating the BIOS file

To update the BIOS file using the AFUDOS utility:

1. Visit the ASUS website (www.asus.com) and download the latest BIOS file for the motherboard. Save the BIOS file to a bootable floppy disk.



Write the BIOS filename on a piece of paper. You need to type the exact BIOS filename at the DOS prompt.

2. Copy the AFUDOS utility (afudos.exe) from the motherboard support CD to the bootable floppy disk you created earlier.
3. Boot the system in DOS mode, then at the prompt, type:

```
afudos /i[filename]
```

where [filename] is the latest or the original BIOS file on the bootable floppy disk, then press <Enter>.

```
A:\>afudos /i8036A0.ROM
```

The utility verifies the file, then starts updating the BIOS file.

```
A:\>afudos /i8036A0.ROM
AMI Firmware Update Utility - Version 1.19(ASUS V2.07(03.11.24BB))
Copyright (C) 2002 American Megatrends, Inc. All rights reserved.

WARNING!! Do not turn off power during flash BIOS
Reading file ..... done
Reading flash ..... done

Advance Check .....
Erasing flash ..... done
Writing flash ..... 0x0008CC00 (9%)
```



DO NOT shut down or reset the system while updating the BIOS to prevent system boot failure!

5. The utility returns to the DOS prompt after the BIOS update process is completed. Reboot the system from the hard disk drive.

```
A:\>afudos /i8036A0.ROM
AMI Firmware Update Utility - Version 1.19 (ASUS V2.07 (03.11.24BB))
Copyright (C) 2002 American Megatrends, Inc. All rights reserved.

WARNING!! Do not turn off power during flash BIOS
Reading file ..... done
Reading flash ..... done

Advance Check .....
Erasing flash ..... done
Writing flash ..... done
Verifying flash .... done

Please restart your computer

A:\>
```

Updating the BIOS file using a USB flash drive

If you have not purchased a USB floppy disk drive, you may update the BIOS file using a USB flash drive. Format the USB flash drive to FAT16 or 32 system file before updating the BIOS.

To format the USB flash drive to a FAT32/16 system file:

1. Insert the USB flash drive to an available USB port.
2. From the Windows desktop, click **Start**, then select **My Computer**.
3. Right-click the USB flash drive icon, then select **Format** from the menu.
4. From the **File system** field, select **FAT32** or **FAT16**, then click the **Start** button.

To update the BIOS file:

1. Copy the original or the latest BIOS file and the AFUDOS utility (afudos.exe) to the USB flash drive.
2. Insert the USB flash drive to an available USB port, then place the motherboard support CD to the optical drive.
3. Boot the system from the support CD, then select the **FreeDOS command prompt**.
4. At the DOS prompt, replace the prompt with the USB flash disk drive letter, then type: `afudos /i [filename]`.
3. Follow the instructions in the previous section to update the BIOS file.

4.1.3 ASUS CrashFree BIOS 3 utility

The ASUS CrashFree BIOS 3 is an auto recovery tool that allows you to restore the BIOS file when it fails or gets corrupted during the updating process. You can update a corrupted BIOS file using a floppy disk or a USB flash drive that contains the updated BIOS file.



Prepare a floppy disk or a USB flash drive containing the updated motherboard BIOS before using this utility.

Recovering the BIOS from a floppy disk

To recover the BIOS from a floppy disk:

1. Turn the system.
2. Insert the floppy disk with the original or updated BIOS file to the floppy disk drive.
3. The utility will automatically recover the BIOS. It resets the system when the BIOS recovery finished.

Recovering the BIOS from a USB flash drive

To recover the BIOS from a USB flash drive:

1. Remove any floppy disk from the floppy disk drive and turn the system.
2. Insert the USB flash drive with the original or updated BIOS file to one USB port on the system.
3. The utility will automatically recover the BIOS. It resets the system when the BIOS recovery finished.



DO NOT shut down or reset the system while recovering the BIOS! Doing so would cause system boot failure!



The recovered BIOS may not be the latest BIOS version for this motherboard. Visit the ASUS website (www.asus.com) to download the latest BIOS file.

4.2 BIOS setup program

This motherboard supports a programmable Low-Pin Count (LPC) chip that you can update using the provided utility described in section **4.1 Managing and updating your BIOS**.

Use the BIOS Setup program when you are installing a motherboard, reconfiguring your system, or prompted to “Run Setup.” This section explains how to configure your system using this utility.

Even if you are not prompted to use the Setup program, you can change the configuration of your computer in the future. For example, you can enable the security password feature or change the power management settings. This requires you to reconfigure your system using the BIOS Setup program so that the computer can recognize these changes and record them in the CMOS RAM of the LPC chip.

The LPC chip on the motherboard stores the Setup utility. When you start up the computer, the system provides you with the opportunity to run this program. Press during the Power-On Self-Test (POST) to enter the Setup utility; otherwise, POST continues with its test routines.

If you wish to enter Setup after POST, restart the system by pressing <Ctrl+Alt+Delete>, or by pressing the reset button on the system chassis. You can also restart by turning the system off and then back on. Do this last option only if the first two failed.

The Setup program is designed to make it as easy to use as possible. Being a menu-driven program, it lets you scroll through the various sub-menus and make your selections from the available options using the navigation keys.



-
- The default BIOS settings for this motherboard apply for most conditions to ensure optimum performance. If the system becomes unstable after changing any BIOS settings, load the default settings to ensure system compatibility and stability. Select the **Load Setup Defaults** item under the Exit Menu. See section **4.8 Exit Menu**.
 - The BIOS setup screens shown in this section are for reference purposes only, and may not exactly match what you see on your screen.
 - Visit the ASUS website (www.asus.com) to download the latest BIOS file for this motherboard.
-

4.2.1 BIOS menu screen

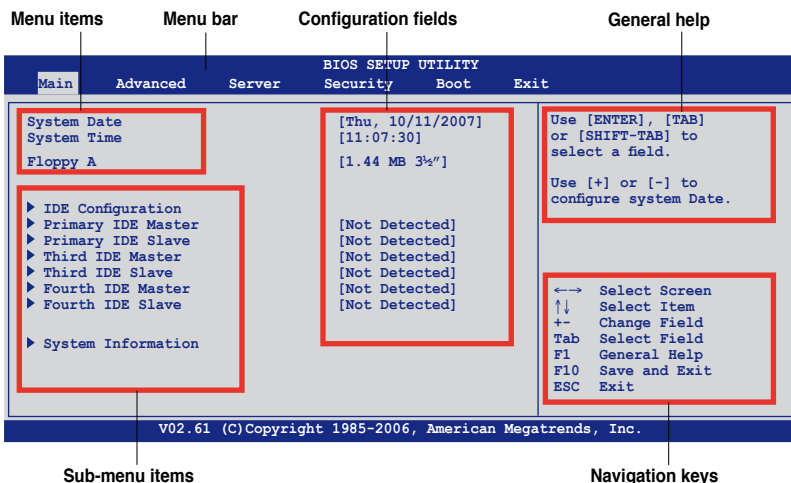

4.2.2 Menu bar

The menu bar on top of the screen has the following main items:

- Main** For changing the basic system configuration
- Advanced** For changing the advanced system settings
- Server** For changing the advanced server options
- Security** For changing the advanced system security options
- Boot** For changing the system boot configuration
- Exit** For selecting the exit options and loading default settings

To select an item on the menu bar, press the right or left arrow key on the keyboard until the desired item is highlighted.

4.2.3 Navigation keys

At the bottom right corner of a menu screen are the navigation keys for that particular menu. Use the navigation keys to select items in the menu and change the settings.



Some of the navigation keys differ from one screen to another.

4.2.4 Menu items

The highlighted item on the menu bar displays the specific items for that menu. For example, selecting Main shows the Main menu items.

The other items (Advanced, Power, Boot, and Exit) on the menu bar have their respective menu items.

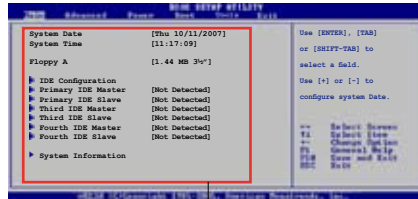

Main menu items

4.2.5 Sub-menu items

A solid triangle before each item on any menu screen means that the item has a sub-menu. To display the sub-menu, select the item and press <Enter>.

4.2.6 Configuration fields

These fields show the values for the menu items. If an item is user-configurable, you can change the value of the field opposite the item. You cannot select an item that is not user-configurable.

A configurable field is enclosed in brackets, and is highlighted when selected. To change the value of a field, select it then press <Enter> to display a list of options. Refer to 4.2.7 Pop-up window.

4.2.7 Pop-up window

Select a menu item then press <Enter> to display a pop-up window with the configuration options for that item.

4.2.8 Scroll bar

A scroll bar appears on the right side of a menu screen when there are items that do not fit on the screen. Press the Up/Down arrow keys or <Page Up> /<Page Down> keys to display the other items on the screen.

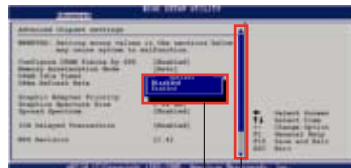

Pop-up window

Scroll bar

4.2.9 General help

At the top right corner of the menu screen is a brief description of the selected item.

4.3 Main menu

When you enter the BIOS Setup program, the Main menu screen appears, giving you an overview of the basic system information.



Refer to section **4.2.1 BIOS menu screen** for information on the menu screen items and how to navigate through them.

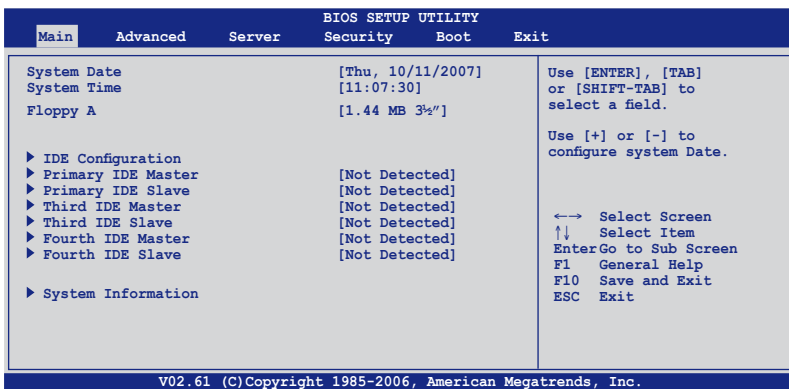

4.3.1 System Date [Day xx/xx/xxxx]

Allows you to set the system date.

4.3.2 System Time [xx:xx:xx]

Allows you to set the system time.

4.3.3 Floppy A [1.44 MB 3 1/2"]

Sets the type of floppy drive installed.

Configuration options: [Disabled] [360 KB 5 1/4"] [1.2 MB 5 1/4"] [720 KB 3 1/2"] [1.44 MB 3 1/2"] [2.88 MB 3 1/2"]

4.3.4 IDE Configuration

The items in this menu allow you to set or change the configurations for the IDE devices installed in the system. Select an item then press <Enter> if you wish to configure the item.

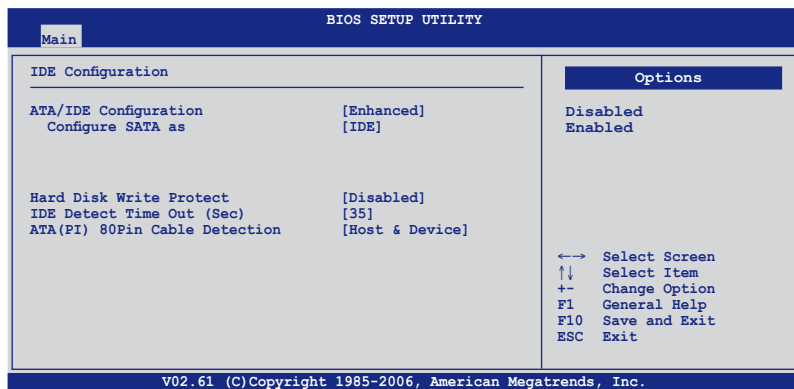

ATA/IDE Configuration [Enhanced]

Configuration options: [Disabled] [Compatible] [Enhanced]

Configure SATA as [IDE]

Sets the configuration for the Serial ATA connectors supported by the Southbridge chip.

The AHCI allows the onboard storage driver to enable advanced Serial ATA features that increases storage performance on random workloads by allowing the drive to internally optimize the order of commands.

If you want to create a RAID 0, RAID 1, RAID 5, RAID 10, or the Intel® Matrix Storage Technology configuration from the Serial ATA hard disk drives, set this item to [RAID].

If you want to use the Serial ATA hard disk drives as Parallel ATA physical storage devices, keep the default setting [IDE].

If you want the Serial ATA hard disk drives to use the Advanced Host Controller Interface (AHCI), set this item to [AHC].

Hard Disk Write Protect [Disabled]

Disables or enables device write protection. This will be effective only if device is accessed through BIOS. Configuration option: [Disabled] [Enabled]

IDE Detect Time Out (Sec) [35]

Selects the time out value for detecting ATA/ATAPI devices.

Configuration options: [0] [5] [10] [15] [20] [25] [30] [35]

ATA(PI) 80Pin Cable Detection [Host & Device]

Allows you to select the mode for detecting 80-pin ATA(PI) cable.
Configuration options: [Host & Device] [Host] [Device]

4.3.5 Primary/Third/Fourth IDE Master/Slave

The BIOS automatically detects the connected IDE devices. There is a separate sub-menu for each IDE device. Select a device item, then press <Enter> to display the IDE device information.

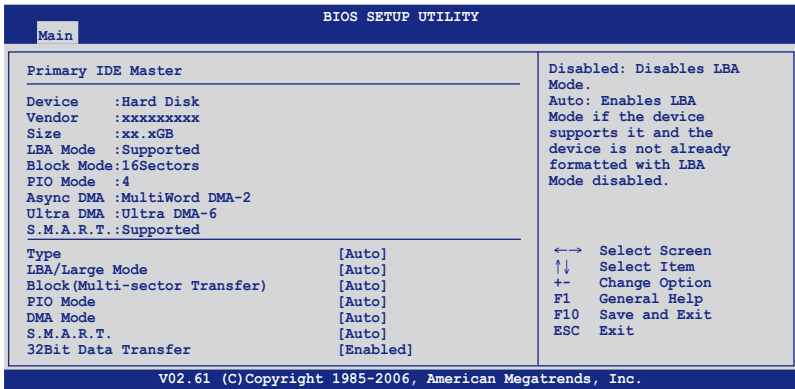

The BIOS automatically detects the values opposite the dimmed items (Device, Vendor, Size, LBA Mode, Block Mode, PIO Mode, Async DMA, Ultra DMA, and S.M.A.R.T. monitoring). These values are not user-configurable. These items show N/A if no IDE device is installed in the system.

Type [Auto]

Selects the type of IDE drive. Setting to [Auto] allows automatic selection of the appropriate IDE device type. Select [CDROM] if you are specifically configuring a CD-ROM drive. Select [ARMD] (ATAPI Removable Media Device) if your device is either a ZIP, LS-120, or MO drive.

Configuration options: [Not Installed] [Auto] [CD/DVD] [ARMD]

LBA/Large Mode [Auto]

Enables or disables the LBA mode. Setting to [Auto] enables the LBA mode if the device supports this mode, and if the device was not previously formatted with LBA mode disabled. Configuration options: [Disabled] [Auto]

Block (Multi-sector Transfer) [Auto]

Enables or disables data multi-sectors transfers. When set to [Auto], the data transfer from and to the device occurs multiple sectors at a time if the device supports multi-sector transfer feature. When set to [Disabled], the data transfer from and to the device occurs one sector at a time.

Configuration options: [Disabled] [Auto]

PIO Mode [Auto]

Allows you to select the data transfer mode.

Configuration options: [Auto] [0] [1] [2] [3] [4]

DMA Mode [Auto]

Sets the DMA mode.

Configuration options: [Auto] [SWDMA0] [SWDMA1] [SWDMA2] [MWDMA0] [MWDMA1] [MWDMA2] [UDMA0] [UDMA1] [UDMA2] [UDMA3] [UDMA4]

S.M.A.R.T. [Auto]

Sets the Smart Monitoring, Analysis, and Reporting Technology.

Configuration options: [Auto] [Disabled] [Enabled]

32Bit Data Transfer [Enabled]

Enables or disables 32-bit data transfer.

Configuration options: [Disabled] [Enabled]

4.3.6 System Information

This menu gives you an overview of the general system specifications. The BIOS automatically detects the items in this menu.

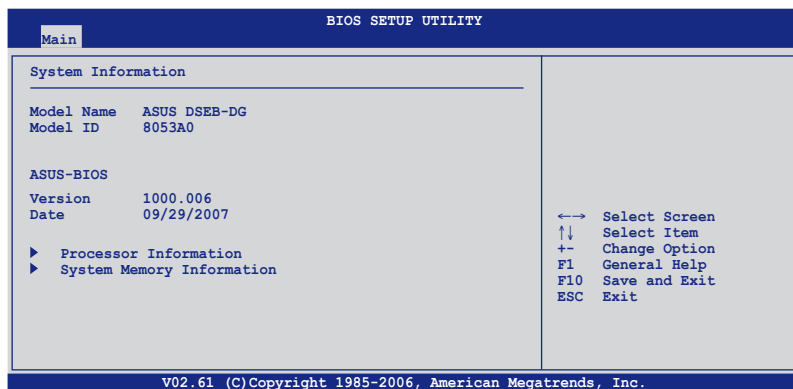

Processor

Displays the installed processor information.

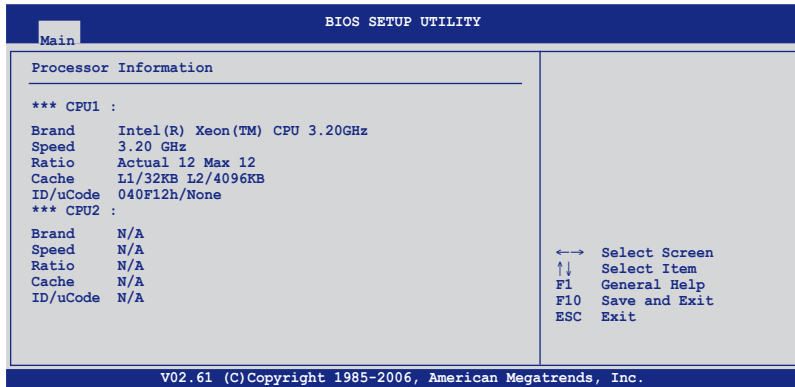

System Memory

Displays the installed system memory information.

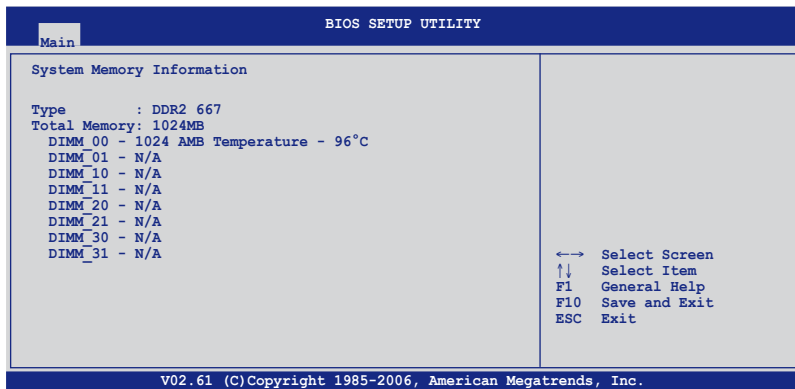

4.4 Advanced menu

The Advanced menu items allow you to change the settings for the CPU and other system devices.



Take caution when changing the settings of the Advanced menu items. Incorrect field values can cause the system to malfunction.

BIOS SETUP UTILITY					
Main	Advanced	Server	Security	Boot	Exit
WARNING: Setting wrong values in the below sections may cause system to malfunction.		Configure CPU.			
<ul style="list-style-type: none">▶ CPU Configuration▶ Chipset Configuration▶ PCI/PnP Configuration▶ USB Configuration▶ Peripheral Configuration▶ ACPI Configuration▶ Power On Configuration▶ Hardware Monitor		<ul style="list-style-type: none">←→ Select Screen↑↓ Select ItemEnter Go to Sub ScreenF1 General HelpF10 Save and ExitESC Exit			
V02.61 (C)Copyright 1985-2006, American Megatrends, Inc.					

4.4.1 CPU Configuration

The items in this menu show the CPU-related information that the BIOS automatically detects. Some items may not appear if your CPU does not support the related functions.

BIOS SETUP UTILITY	
Advanced	
Configure advanced CPU settings	Sets the ratio between CPU Core Clock and the FSB Frequency. Note: Only available when SpeedStep technology is disabled.
Ratio CMOS Setting [12]	<ul style="list-style-type: none">←→ Select Screen↑↓ Select Item+ - Change OptionF1 General HelpF10 Save and ExitESC Exit
Hardware Prefetcher [Enabled]	
Adjacent Cache Line Prefetch [Enabled]	
Max CPUID Value Limit [Disabled]	
Virtualization Technology [Enabled]	
Execute-Disable Bit Capability [Enabled]	
Hyper Threading Technology [Enabled]	
CLE Support [Enabled]	
CPU TM function [Enabled]	
Execute-Disable Bit Capability [Enabled]	
Intel(R) SpeedStep(tm) tech [Enabled]	
V02.61 (C)Copyright 1985-2006, American Megatrends, Inc.	

Ratio CMOS Setting [12]

Whether this item is configurable depends on your CPU type. The valid value ranges differently according to your CPU type. If this item is configurable, enter the value using the numeric keypad.

Hardware Prefetcher [Enabled]

Enable this item to use the Hardware Prefetcher Disable Feature.

Configuration options: [Disabled] [Enabled]

***Adjacent Cache Line Prefetch [Enabled]**

Configuration options: [Disabled] [Enabled]

Max CPUID Value Limit [Disabled]

Setting this item to [Enabled] allows legacy operating systems to boot even without support for CPUs with extended CPUID functions.

Configuration options: [Disabled] [Enabled]

Virtualization Technology [Enabled]

The Vanderpool Virtualization Technology allows a hardware platform to run multiple operating systems separately, enabling one system to virtually function as several systems. Configuration options: [Disabled] [Enabled]

Execute-Disable Bit Capability [Enabled]

Allows you to enable or disable the No-Execution Page Protection Technology. Setting this item to [Disabled] forces the XD feature flag to always return to zero (0). Configuration options: [Disabled] [Enabled]

Hyper Threading Technology [Enabled]

Allows you to enable or disable the Intel® Hyper-Threading Technology feature.

Configuration options: [Disabled] [Enabled]

C1E Support [Enabled]

Allows you to enable or disable C1E support.

Configuration options: [Enabled] [Disabled]

CPU TM function [Enabled]

This function enables the overheated CPU to throttle the clock speed to cool down.

Configuration options: [Disabled] [Enabled]

Execute-Disable Bit [Enabled]

When this item is set to [Disabled], the BIOS forces the XD feature flag to always return to zero (0). Configuration options: [Enabled] [Disabled]

Intel(R) SpeedStep(tm) tech. [Enabled]

Allows you to enable or disable the Intel SpeedStep Technology. Refer to the Appendix for more information on the Intel SpeedStep Technology.

Configuration options: [Disabled] [Enabled]



Items above with * mark are for technical personnel to debug only.

4.4.2 Chipset Configuration

The Chipset configuration menu allows you to change advanced chipset settings. Select an item then press <Enter> to display the sub-menu.

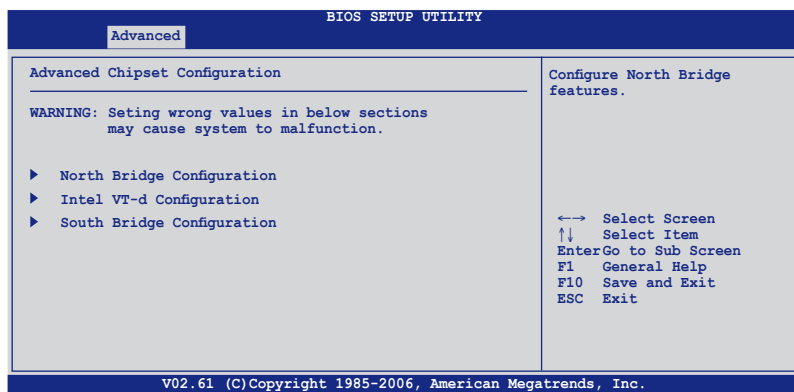

North Bridge Configuration

The North Bridge Configuration menu allows you to change the Northbridge settings.

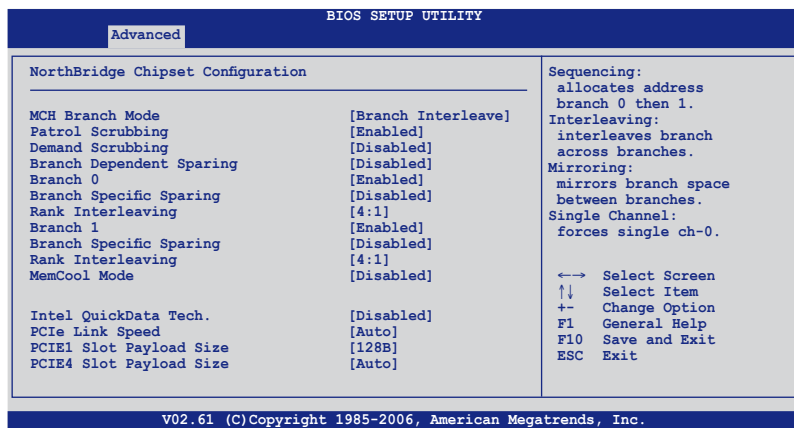

MCH Branch Mode [Branch Interleave]

Allows you to select the MCH branch mode.

Configuration options: [Branch Sequencing] [Branch Interleave] [Branch Mirroring] [Single Channel 0]

Patrol Scrubbing [Enabled]

Enables or disables the Patrol Scrubbing.

Configuration options: [Disabled] [Enabled]

Demand Scrubbing [Enabled]

Enables or disables the Demand Scrubbing.

Configuration options: [Disabled] [Enabled]

Branch Dependent Sparing [Disabled]

Allows you to enable or disabled the branch-dependent DIMM sparing feature.

Configuration options: [Disabled] [Enabled]

Branch 0 [Enabled]

Allows you to enable or disable the Branch 0. If you set this item to [Disabled], the following three items will be grayed out.

Configuration options: [Disabled] [Enabled]

Branch Specific Sparing [Disabled]

Allows you to enable or disable the DIMM sparing feature.

Configuration options: [Disabled] [Enabled]

Rank Interleaving [4:1]

Allows you to select the Branch 0 Rank Interleave.

Configuration options: [1:1] [2:1] [4:1]

Branch 1 [Enabled]

Allows you to enable or disable the Branch 1. If you set this item to [Disabled],

Branch 0 and the following two items will be grayed out.

Configuration options: [Disabled] [Enabled]

Branch Specific Sparing [Disabled]

Allows you to enable or disable the DIMM sparing feature.

Configuration options: [Disabled] [Enabled]

Rank Interleaving [4:1]

Allows you to select the Branch 1 Rank Interleave.

Configuration options: [1:1] [2:1] [4:1]

MemCool Mode [Disabled]

Allows you to enable or disable the MemCool Mode.

Configuration options: [Disabled] [Enabled]

Intel QuickData Tech. [Disabled]

Allows you to enable or disable Intel QuickData Tech. function.

Configuration options: [Enabled] [Disabled]

PCIe Link Speed [Auto]

Allows you to set the PCIe link speed. When set to [Auto], the PCIe device runs at the speed depending on the capability of the PCI Express port of MCH. When set to [PCIe Gen1], the target link speed will be forced to meet the PCIe Gen1 specification. Configuration options: [Auto] [PCIe Gen1]

PCIe1 Slot Payload Size [128B]

Allows you to set the maximum TLP payload size for the PCI Express port. Configuration options: [Auto] [128B] [256B]

PCIe4 Slot Payload Size [Auto]

Allows you to set the maximum TLP payload size for the PCI Express port. Configuration options: [Auto] [128B] [256B]

Intel VT-d Configuration

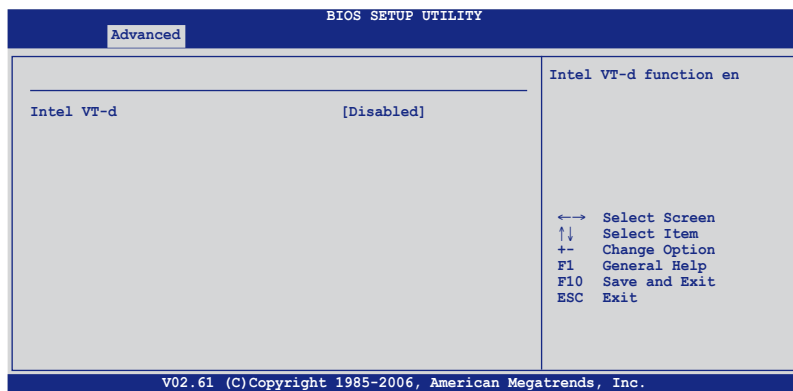

Intel VT-d [Disabled]

Allows you to enable or disable Intel VT-d function. Configuration options: [Disabled] [Enabled]

South Bridge Configuration

The SouthBridge Configuration menu allows you to change the Southbridge settings.

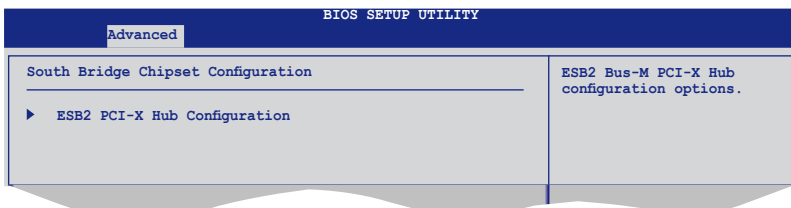

ESB2 PCI-X Hub Configuration

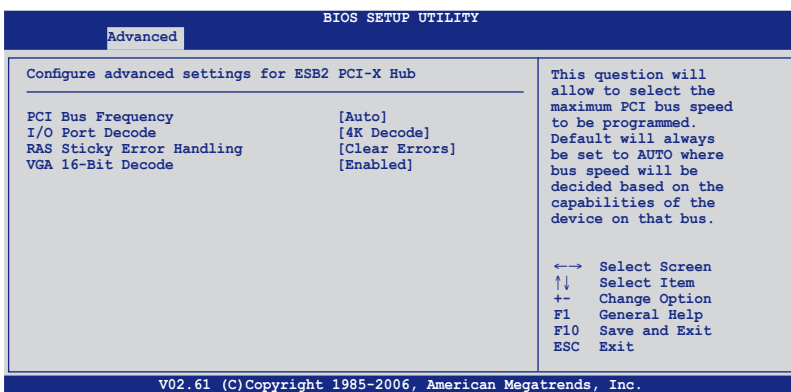

PCI Bus Frequency [Auto]

Allows you to select the PCI bus speed. When you set this item to [Auto], the device will run at the speed based on its capability.

Configuration options: [Auto] [33 Mhz PCI] [66 Mhz PCI] [66 Mhz PCI-X M1] [100 Mhz PCI-X M1] [133 Mhz PCI-X M1] [66 Mhz PCI-X M2] [100 Mhz PCI-X M2] [133 Mhz PCI-X M2]

I/O Port Decode [4K Decode]

Allows you to select the decode range for I/O ports.

Configuration options: [4K Decode] [1K Decode]

RAS Sticky Error Handling [Clear Errors]

Allows you to select the method of handling the Sticky RAS errors.

Configuration options: [Clear Errors] [Leave Errors]

VGA 16-Bit Decode [Enabled]

Allows you to enable or disable the decoding of VGA for the devices behind PXH. Configuration options: [Disabled] [Enabled]

4.4.3 PCI PnP

The PCI PnP menu items allow you to change the advanced settings for PCI/PnP devices. The menu includes setting IRQ and DMA channel resources for either PCI/PnP or legacy ISA devices, and setting the memory size block for legacy ISA devices.



Take caution when changing the settings of the PCI PnP menu items. Incorrect field values can cause the system to malfunction.

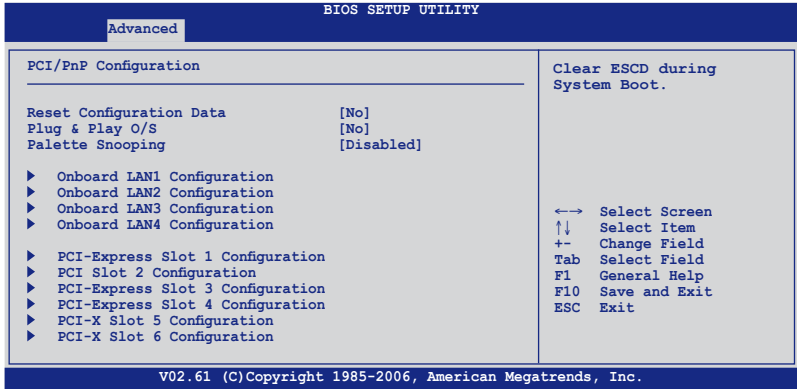

Reset Configuration Data [No]

Clears the non-volatile RAM (NVRAM) during boot.

Configuration options: [No] [Yes]

Plug And Play O/S [No]

When set to [No], BIOS configures all the devices in the system. When set to [Yes] and if you install a Plug and Play operating system, the operating system configures the Plug and Play devices not required for boot.

Configuration options: [No] [Yes]

Palette Snooping [Disabled]

When set to [Enabled], the palette snooping feature informs the PCI devices that an ISA graphics device is installed in the system so that the latter can function correctly. Configuration options: [Disabled] [Enabled]

Onboard LAN1/2/3/4 Configuration

BIOS SETUP UTILITY	
Advanced	
Onboard LAN Configuration	Initialize device expansion ROM.
Option ROM Scan	[Enabled]
Option ROM Priority	[Normal]
Bus Master	[Enabled]
Latency Timer	[Default]

Option ROM Scan: [Enabled]

Allows you to enable or disable the device expansion ROM.

Configuration options: [Disabled] [Enabled]

Option ROM Priority [Normal]

Allows you to set the option ROM priority.

Configuration options: [Low] [Normal] [High] [Highest]

Bus Master [Enabled]

Set this item to [Enabled] to enable the selected device as a PCI bus master.

Latency Timer [Default]

Allows you to set the PCI device latency timer register.

Configuration options: [Default] [32] [64] [96] [128] [160] [192] [224]

PCI-Express Slot1/3/4; PCI Slot 2; PCI-X Slot 5/6 Configuration

BIOS SETUP UTILITY	
Advanced	
PCI-Express Slot 1 Configuration	Initialize device expansion ROM.
Option ROM Scan	[Enabled]
Option ROM Priority	[Normal]
Bus Master	[Enabled]
Latency Timer	[Default]

Option ROM Scan: [Enabled]

Allows you to enable or disable the device expansion ROM.

Configuration options: [Disabled] [Enabled]

Option ROM Priority [Normal]

Allows you to set the option ROM priority.

Configuration options: [Low] [Normal] [High] [Highest]

Bus Master [Enabled]

Set this item to [Enabled] to enable the selected device as a PCI bus master.

Latency Timer [Default]

Allows you to set the PCI device latency timer register.

Configuration options: [Default] [32] [64] [96] [128] [160] [192] [224]

4.4.4 USB Configuration

The items in this menu allows you to change the USB-related features. Select an item then press <Enter> to display the configuration options.

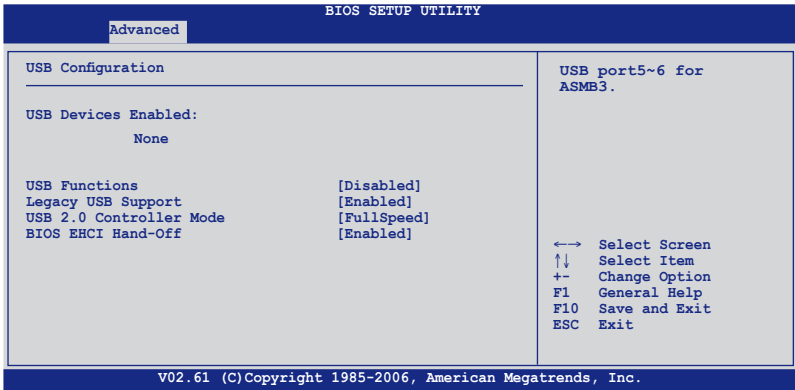

The **USB Devices Enabled** item shows the auto-detected values. If no USB device is detected, the item shows None.

USB Functions [Enabled]

Allows you to enable the USB host controller.

Configuration options: [Disabled] [2 USB ports] [4 USB ports] [6 USB ports]



The following item appears only when you set **USB Function** to [2 USB ports] [4 USB ports] [6 USB ports].

Legacy USB Support [Enabled]

Allows you to enable or disable support for legacy USB devices. Setting to [Auto] allows the system to detect the presence of USB devices at startup. If detected, the USB controller legacy mode is enabled. If no USB device is detected, the legacy USB support is disabled. Configuration options: [Disabled] [Enabled] [Auto]



The following items appear when you set **Legacy USB Support** to [Enabled] or [Auto]

BIOS EHCI Hand-Off [Enabled]

Enables or disables the BIOS EHCI hand-off support.

Configuration options: [Disabled] [Enabled]

4.4.5 Peripheral Configuration

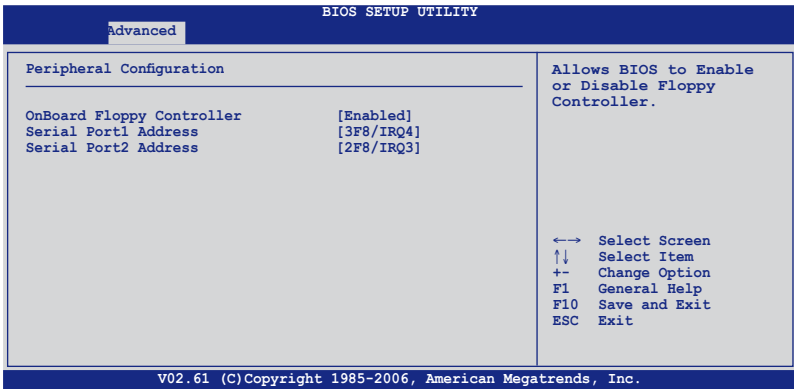

OnBoard Floppy Controller [Enabled]

Enables or disables the onboard floppy controller.

Configuration options: [Disabled] [Enabled]

Serial Port1 Address [3F8/IRQ4]

Allows you to select the Serial Port1 base address.

Configuration options: [Disabled] [3F8/IRQ4] [3E8/IRQ4] [2E8/IRQ3]

Serial Port2 Address [2F8/IRQ3]

Allows you to select the Serial Port2 base address.

Configuration options: [Disabled] [2F8/IRQ3] [3E8/IRQ4] [2E8/IRQ3]

4.4.6 ACPI Configuration

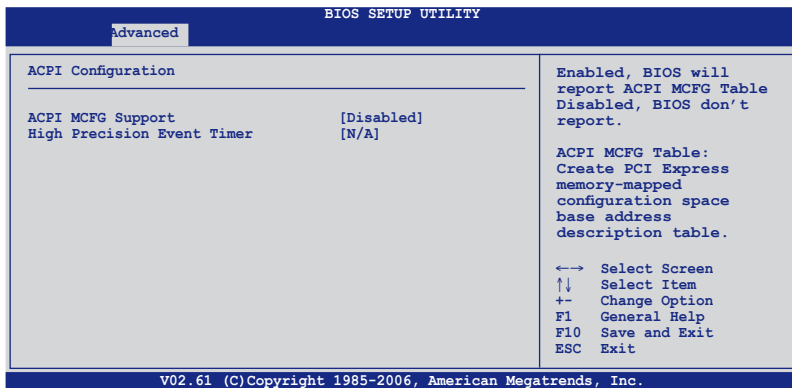

ACPI MCFG Support [Enabled]

Enables or disables the ACPI MCFG support. When this item is set to [Enabled], the BIOS will report the ACPI MCFG table.

Configuration options: [Disabled] [Enabled]

High Precision Event Timer [N/A]

Allows you to enable or disable the High Precision Event Timer.

Configuration options: [Disabled] [Enabled]

4.4.7 Power On Configuration

This sub-menu allows you to change Power On Configuration features. Select an item then press <Enter> to display the configuration options.

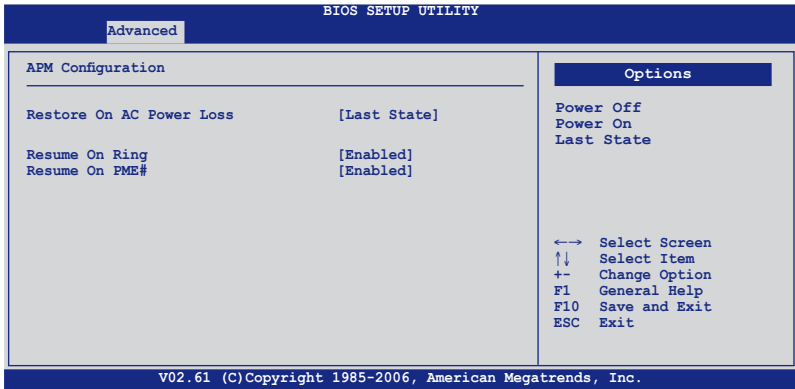

Restore on AC Power Loss [Last State]

When set to [Power Off], the system goes into off state after an AC power loss. When set to [Power On], the system will reboot after an AC power loss. When set to [Last State], the system goes into either off or on state, whatever the system state was before the AC power loss.

Configuration options: [Power Off] [Power On] [Last State]

Resume On Ring [Enabled]

When set to [Enabled], the system will generate a wake event when the external modem receives a call while the computer is in Soft-off mode.

Configuration options: [Disabled] [Enabled]

Resume On PME# [Enabled]

When set to [Enabled], the system enables the PME to generate a wake event while the computer is in Soft-off mode.

Configuration options: [Disabled] [Enabled]

4.4.8 Hardware Monitor

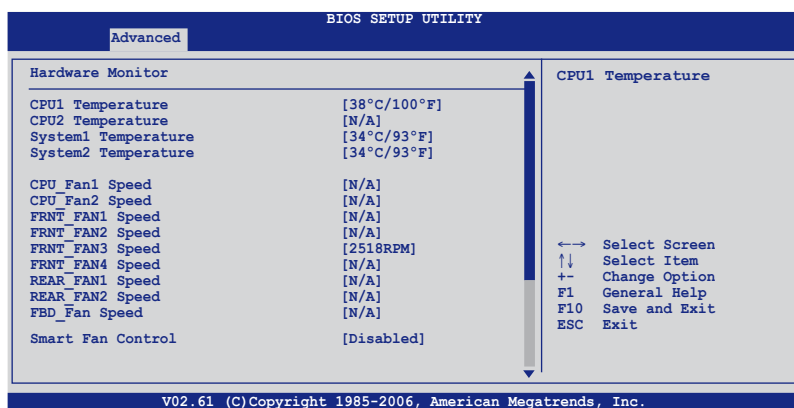

Scroll down for more items.

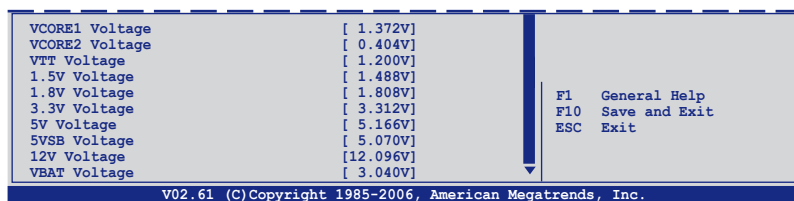

CPU1/CPU2 Temperature [xxx°C/xxx°F]

System1/2 Temperature [xxx°C/xxx°F]

The onboard hardware monitor automatically detects and displays the motherboard and CPU temperatures. Select [Ignored] if you do not wish to display the detected temperatures. The CPU2 Temperature shows N/A if no processor is installed in CPU2 socket.

CPU_Fan1/2; FRNT_FAN1/2/3/4 Speed [xxxxRPM] or [N/A]

REAR_FAN1/2; FBD_Fan Speed [xxxxRPM] or [N/A]

The onboard hardware monitor automatically detects and displays the CPU, front, rear and FBD fan speed in rotations per minute (RPM). If the fan is not connected to the motherboard, the field shows N/A.

Smart Fan Control [Disabled]

Allows you to enable or disable the ASUS Smart Fan feature that smartly adjusts the fan speeds for more efficient system operation.

Configuration options: [Disabled] [Smart Fan] [Smart Fan II]



The following items appear when you enable the Smart Fan Control feature.

System1/2 Target Temperature [45]

Allows you to set the system target temperature.

Configuration options: [35]~[55]

**VCORE1 Voltage, VCORE2 Voltage, VTT Voltage, 1.5V Voltage,
1.8V Voltage, 3.3V Voltage, 5V Voltage, 5VSB Voltage, 12V Voltage,
VBAT Voltage**

The onboard hardware monitor automatically detects the voltage output through the onboard voltage regulators. The VCORE2 item shows N/A if no processor is installed in CPU2 socket.

4.5 Server menu

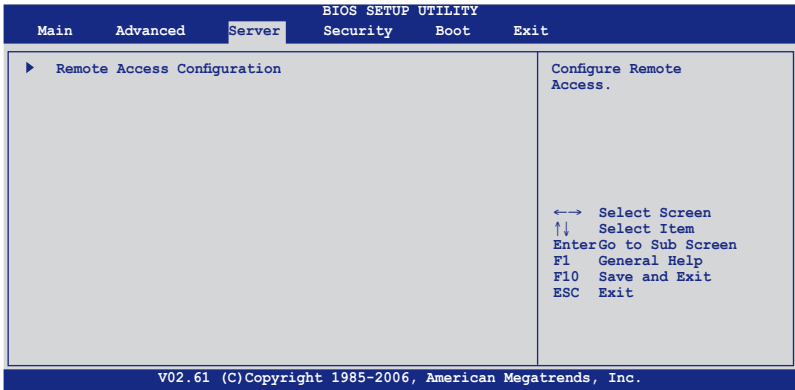

4.5.1 Remote Access Configuration

The items in this menu allows you to configure the Remote Access features. Select an item then press <Enter> to display the configuration options.

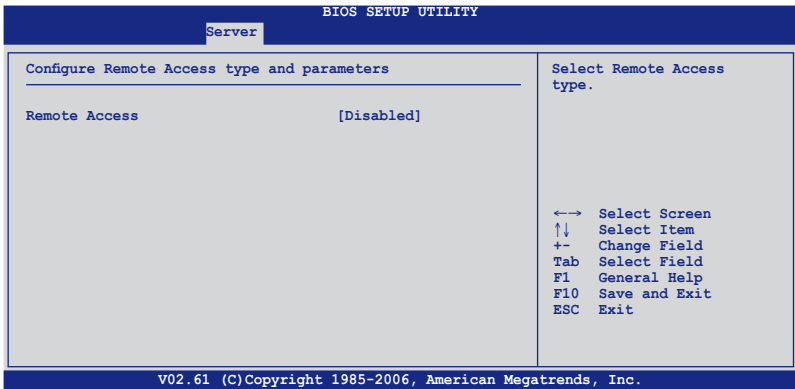

Remote Access [Disabled]

Enables or disables the remote access feature.

Configuration options: [Disabled] [Enabled]



The following items appear only when **Remote Access** is set to [Enabled].

Serial port number [COM2]

Selects the serial port for console redirection.

Configuration options: [COM1] [COM2]

Baudrate [115200 8,n,1]

Sets the baudrate. Configuration options: [115200 8,n,1] [57600 8,n,1]

[38400 8,n,1] [19200 8,n,1]

Flow Control [None]

Allows you to select the flow control for console redirection.

Configuration options: [None] [Hardware] [Software]

Redirection After BIOS POST [Disabled]

Sets the redirection mode after the BIOS Power-On Self-Test (POST). Some operating system may not work when set to Always.

Configuration options: [Disabled] [Boot Loader] [Always]

Terminal Type [ANSI4]

Allows you to select the target terminal type.

Configuration options: [ANSI4] [VT100] [VT-UTF83] [Extended VT100]

VT-UTF8 Combo Key Support [Disabled]

Enables or disables the VT-UTF8 combo key support for ANSI or VT100 terminals.

Configuration options: [Disabled] [Enabled]

4.6 Security

The Security menu items allow you to change the system security settings. Select an item then press <Enter> to display the configuration options.

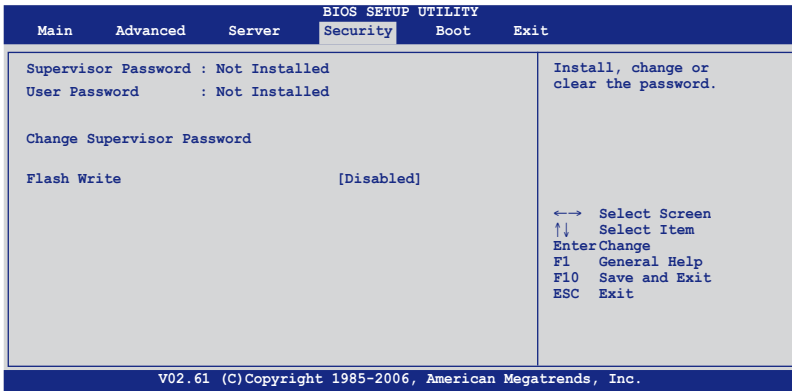

Change Supervisor Password

Select this item to set or change the supervisor password. The **Supervisor Password** item on top of the screen shows the default **Not Installed**. After you set a password, this item shows **Installed**.

To set a Supervisor Password:

1. Select the **Change Supervisor Password** item and press <Enter>.
2. From the password box, type a password composed of at least six letters and/or numbers, then press <Enter>.
3. Confirm the password when prompted.

The message “Password Installed” appears after you successfully set your password.

To change the supervisor password, follow the same steps as in setting a user password.

To clear the supervisor password, select the **Change Supervisor Password** then press <Enter>. The message “Password Uninstalled” appears.



If you forget your BIOS password, you can clear it by erasing the CMOS Real Time Clock (RTC) RAM. See section **2.6 Jumper** for information on how to erase the RTC RAM.

After you have set a supervisor password, the other items appear to allow you to change other security settings.

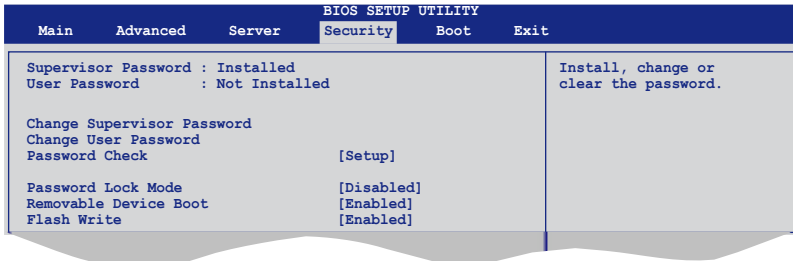

Change User Password

Select this item to set or change the user password. The **User Password** item on top of the screen shows the default **Not Installed**. After you set a password, this item shows Installed.

To set a User Password:

1. Select the **Change User Password** item and press <Enter>.
2. On the password box that appears, type a password composed of at least six letters and/or numbers, then press <Enter>.
3. Confirm the password when prompted.

The message "Password Installed" appears after you set your password successfully.

To change the user password, follow the same steps as in setting a user password.

Password Check [Setup]

When set to [Setup], BIOS checks for user password when accessing the Setup utility. When set to [Always], BIOS checks for user password both when accessing Setup and booting the system. Configuration options: [Setup] [Always]

Password Lock Mode [Disabled]

When set to [Enabled], the keyboard will be locked during the adapter card installation. Configuration options: [Disabled] [Enabled]

Removable Device Boot [Enabled]

When this item is set to [Disabled], the system cannot boot from the removable devices. Configuration options: [Disabled] [Enabled]

Flash Write [Disabled]

When this item is set to [Disabled], the BIOS flash memory will be write-protected. Configuration options: [Disabled] [Enabled]

4.7 Boot menu

The Boot menu items allow you to change the system boot options. Select an item then press <Enter> to display the sub-menu.

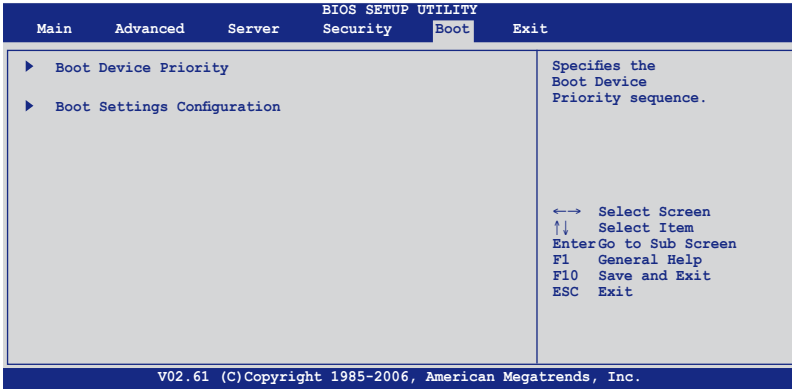

4.7.1 Boot Device Priority

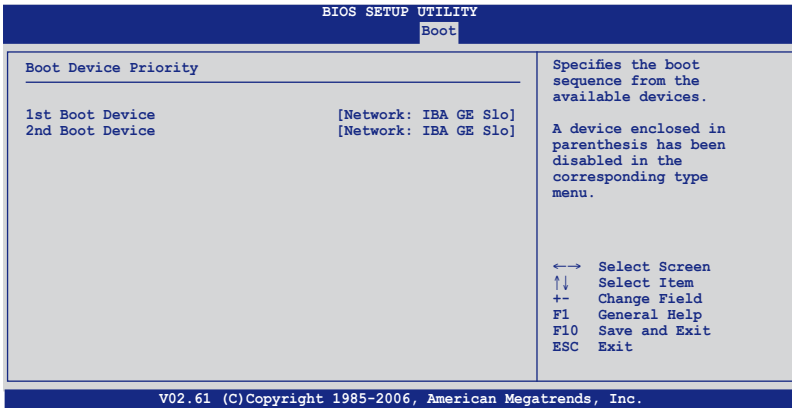

1st ~ xxth Boot Device [XXXXXXXX]

These items specify the boot device priority sequence from the available devices. The number of device items that appears on the screen depends on the number of devices installed in the system. Configuration options: [xxxxx Drive] [Disabled]

4.7.2 Boot Settings Configuration

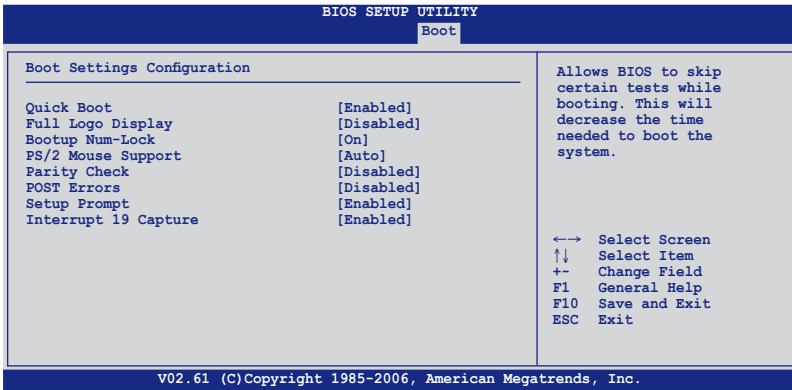

Quick Boot [Enabled]

Enabling this item allows the BIOS to skip some power on self tests (POST) while booting to decrease the time needed to boot the system. When set to [Disabled], BIOS performs all the POST items.

Configuration options: [Disabled] [Enabled]

Full Logo Display [Disabled]

Allows you to enable or disable the full screen logo display feature.

Configuration options: [Disabled] [Enabled]



Set this item to [Enabled] to use the ASUS MyLogo2™ feature.

Bootup Num-Lock [On]

Allows you to select the power-on state for the NumLock.

Configuration options: [Off] [On]

PS/2 Mouse Support [Auto]

Allows you to enable or disable support for PS/2 mouse.

Configuration options: [Disabled] [Enabled] [Auto]

Parity Check [Disabled]

Allows you to enable or disable the memory or parity error check.

Configuration options: [Disabled] [Enabled]

POST Errors [Disabled]

When set to [Enabled], the system waits for the <F1> key to be pressed when error occurs. Configuration options: [Disabled] [Enabled]

Setup Prompt [Enabled]

When set to [Enabled], the system displays the message "Press DEL to run Setup" during POST. Configuration options: [Disabled] [Enabled]

Interrupt 19 Capture [Enabled]

When set to [Enabled], this function allows the option ROMs to trap Interrupt 19.
Configuration options: [Disabled] [Enabled]

4.8 Exit menu

The Exit menu items allow you to load the optimal or failsafe default values for the BIOS items, and save or discard your changes to the BIOS items.

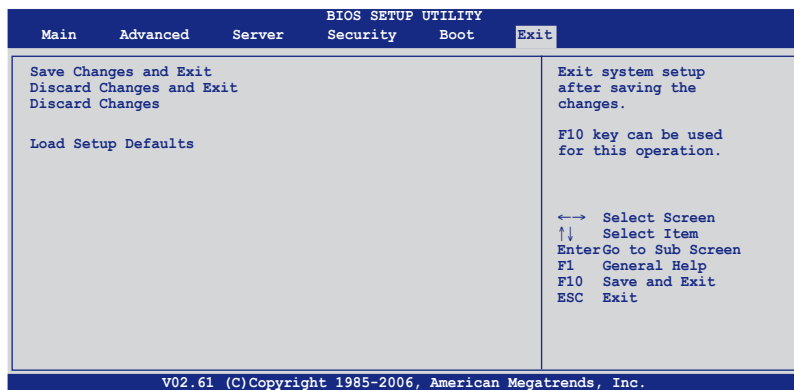

Pressing <Esc> does not immediately exit this menu. Select one of the options from this menu or <F10> from the legend bar to exit.

Exit & Save Changes

Once you are finished making your selections, choose this option from the Exit menu to ensure the values you selected are saved to the CMOS RAM. An onboard backup battery sustains the CMOS RAM so it stays on even when the PC is turned off. When you select this option, a confirmation window appears. Select **YES** to save changes and exit.



If you attempt to exit the Setup program without saving your changes, the program prompts you with a message asking if you want to save your changes before exiting. Press <Enter> to save the changes while exiting.

Exit & Discard Changes

Select this option only if you do not want to save the changes that you made to the Setup program. If you made changes to fields other than System Date, System Time, and Password, the BIOS asks for a confirmation before exiting.

Discard Changes

This option allows you to discard the selections you made and restore the previously saved values. After selecting this option, a confirmation appears. Select **YES** to discard any changes and load the previously saved values.

Load Setup Defaults

This option allows you to load the default values for each of the parameters on the Setup menus. When you select this option or if you press <F5>, a confirmation window appears. Select **YES** to load default values. Select **Exit & Save Changes** or make other changes before saving the values to the non-volatile RAM.

This chapter provides instructions for setting up, creating, and configuring RAID sets using the available utilities.

5 RAID configuration

5.1	Setting up RAID.....	5-1
5.2	LSI Logic Embedded SATA RAID Setup Utility.....	5-3
5.3	Intel® Matrix Storage Manager Option ROM Utility	5-30
5.4	Global Array Manager.....	5-38
5.5	Marvel® 88SE6145 RAID BIOS configuration utility (<i>DSEB-DG model only</i>)	5-40
5.6	LSI Logic MPT Setup Utility (<i>DSEB-DG/SAS model only</i>).....	5-46

5.1 Setting up RAID

The motherboard comes with the following RAID solutions:

DSEB-DG model

- LSI Logic Embedded SATA RAID and the Intel Matrix Storage Manager embedded in the Intel 6321ESB Southbridge supports Serial ATA hard disk drives and RAID0, RAID1, and RAID10 configurations. The Intel Matrix Storage Manager also supports RAID5 configuration.
- The Marvell® 88SE6145 is a host bus adapter chip between PCI-Express and Serial ATA (SATA)/Parallel ATA (PATA) devices. It employs the latest Serial ATA (SATA) Phy technology, operating at 1.5 Gb/s or 3.0 Gb/s. The motherboard supports the following RAID configurations: RAID0, RAID1, RAID10 and RAID5.

DSEB-DG/SAS model

- Intel Matrix Storage Manager embedded in the Intel 6321ESB Southbridge supports Serial ATA hard disk drives and RAID0, RAID1, RAID10 and RAID5 configurations.
- LSI1068 PCI-X SAS controller supports SAS disk drives and RAID0, RAID1, and RAID1E configuration.

5.1.1 RAID definitions

RAID 0 (*Data striping*) optimizes two identical hard disk drives to read and write data in parallel, interleaved stacks. Two hard disks perform the same work as a single drive but at a sustained data transfer rate, double that of a single disk alone, thus improving data access and storage. Use of two new identical hard disk drives is required for this setup.

RAID 1 (*Data mirroring*) copies and maintains an identical image of data from one drive to a second drive. If one drive fails, the disk array management software directs all applications to the surviving drive as it contains a complete copy of the data in the other drive. This RAID configuration provides data protection and increases fault tolerance to the entire system. Use two new drives or use an existing drive and a new drive for this setup. The new drive must be of the same size or larger than the existing drive.

RAID 1-E (*Enhanced RAID 1*) has a striped layout with each stripe unit having a secondary (or alternate) copy stored on a different disk. You can use three or more hard disk drives for this configuration.

RAID 10 is data striping and data mirroring combined without parity (redundancy data) having to be calculated and written. With the RAID 10 configuration you get all the benefits of both RAID 0 and RAID 1 configurations. Use four new hard disk drives or use an existing drive and three new drives for this setup.

RAID 5 stripes both data and parity information across three or more hard disk drives. Among the advantages of RAID 5 configuration include better HDD performance, fault tolerance, and higher storage capacity. The RAID 5 configuration is best suited for transaction processing, relational database applications, enterprise resource planning, and other business systems. Use a minimum of three identical hard disk drives for this setup.



If you want to boot the system from a hard disk drive included in a created RAID set, copy first the RAID driver from the support CD to a floppy disk before you install an operating system to the selected hard disk drive.

5.1.2 Installing hard disk drives

The motherboard supports Serial ATA for RAID set configuration. For optimal performance, install identical drives of the same model and capacity when creating a disk array.

To install the SATA hard disks for RAID configuration:

1. Install the SATA hard disks into the drive bays following the instructions in the system user guide.
2. Connect a SATA signal cable to the signal connector at the back of each drive and to the SATA connector on the motherboard.
3. Connect a SATA power cable to the power connector on each drive.

5.1.3 Setting the RAID item in BIOS

You must set the RAID item in the BIOS Setup before you can create a RAID set from SATA hard disk drives attached to the SATA connectors supported by the Intel® 6321ESB Southbridge chip. To do this:

1. Enter the BIOS Setup during POST.
2. Go to the **Main Menu > IDE Configuration > S-ATA Configuration**, then press <Enter>.
3. Set the **SATA Controller Mode Option** item to [Enhanced], then press <Enter>.
4. Set the **SATA RAID Enable** item to [Enabled].
5. Save your changes, then exit the BIOS Setup.



Refer to Chapter 4 for details on entering and navigating through the BIOS Setup.

5.1.4 RAID configuration utilities

Depending on the RAID connectors that you use, you can create a RAID set using the utilities embedded in each RAID controller. For example, use the **LSI Logic Embedded SATA RAID Setup Utility** or the **Intel® Matrix Storage Manager** if you installed Serial ATA hard disk drives on the Serial ATA connectors supported by the Intel® 6321ESB Southbridge.

For DSEB-DG/SAS model, you may use the **LSI1068 SAS Configuration Utility** if you installed SAS hard disk drives to the mini-SAS connector(s) supported by the LSI1068 PCI-X SAS controller.

Refer to the succeeding sections for details on how to use each RAID configuration utility.

5.2 LSI Logic Embedded SATA RAID Setup Utility

The LSI Logic Embedded SATA RAID Setup Utility allows you to create RAID 0, RAID 1, or RAID 10 set(s) from SATA hard disk drives connected to the SATA connectors supported by the motherboard Southbridge chip.

To enter the LSI Logic Embedded SATA RAID Setup Utility:

1. Turn on the system after installing all the SATA hard disk drives.
2. During POST, the LSI Logic Embedded SATA RAID Setup Utility automatically detects the installed SATA hard disk drives and displays any existing RAID set(s). Press <Ctrl> + <M> to enter the utility.



```
LSI Logic Embedded SATA RAID BIOS Version 5.4.05091647R
(c)2004 Copyright LSI Logic Corporation. All Rights Reserved.

LSI Logic Embedded SATA RAID Found at PCI Bus No:00 Dev No:1F
Scanning For Port 0 ... Responding: HD5722512A.S400 117800MB UDMA 5
Scanning For Port 1 ... Responding: HD5722512A.S400 117800MB UDMA 5

01 Logical drive(s) Configured.
Array# Mode Stripe Size No.Of Stripes DriveSize Status
00 Reliability 64KB(128 Sectors) 02 114376MB Online

Press Ctrl-M to run LSI Logic Embedded SATA RAID Setup Utility.
```



- The LSI Logic Embedded SATA RAID auto configures to RAID 1 when the SATA to RAID Mode is enabled.
- The RAID setup screens shown in this section are for reference only and may not exactly match the items on your screen due to the controller version difference.

3. The utility main window appears. Use the arrow keys to select an option from the Management Menu, then press <Enter>. Refer to the Management Menu descriptions on the next page.

At the bottom of the screen is the legend box. The keys on the legend box allow you to navigate through the setup menu options or execute commands. The keys on the legend box vary according to the menu level.



Menu	Description
Configure	Allows you to create RAID 0 or RAID 1 set using the Easy Configuration or the New Configuration command. This menu also allows you to view, add, or clear RAID configurations or select the boot drive
Initialize	Allows you to initialize the logical drives of a created RAID set
Objects	Allows you to initialize logical drives or change the logical drive parameters
Rebuild	Allows you to rebuild failed drives
Check Consistency	Allows you to check the data consistency of the logical drives of a created RAID set

5.2.1 Creating a RAID 0 or RAID 1 set

The LSI Logic Embedded SATA RAID Setup Utility allows you to create a RAID 0 or RAID 1 set using two types of configurations: **Easy** and **New**.

In Easy Configuration, the logical drive parameters are set automatically including the size and stripe size (RAID 1 only).

In New Configuration, you manually set the logical drive parameters and assign the set size and stripe size (RAID 1 only).

Using Easy Configuration

To create a RAID set using the Easy Configuration option:

1. From the utility main menu, highlight **Configure**, then press <Enter>.
2. Use the arrow keys to select **Easy Configuration**, then press <Enter>.



- The **ARRAY SELECTION MENU** displays the available drives connected to the SATA ports. Select the drives you want to include in the RAID set, then press <SpaceBar>. When selected, the drive indicator changes from **READY** to **ONLIN A[X]-[Y]**, where X is the array number, and Y is the drive number.

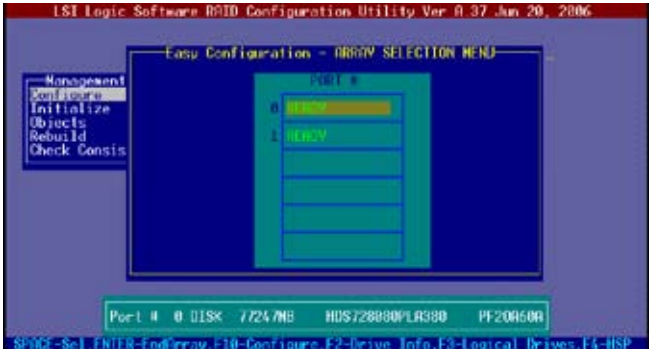

The information of the selected hard disk drive displays at the bottom of the screen.

- Select all the drives required for the RAID set, then press <Enter>. The configurable array appears on screen.

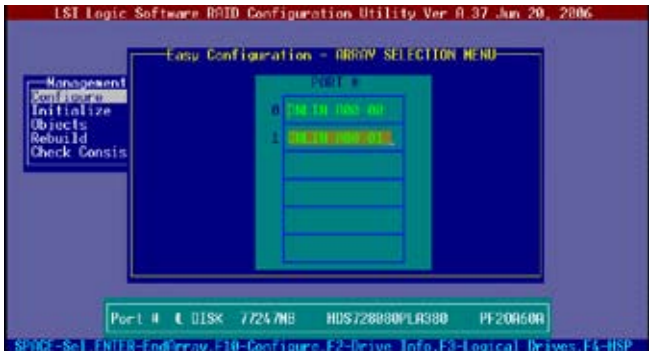

5. Press <F10>, select the configurable array, then press <SpaceBar>.

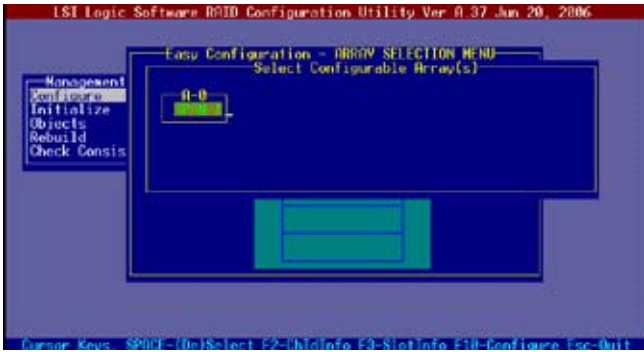

Press <F10> again, the logical drive information appears including a **Logical Drive** menu that allows you to change the logical drive parameters.



6. Select **RAID** from the **Logical Drive** menu, then press <Enter>.
7. Select the **RAID** level from the menu, then press <Enter>.



You need at least two identical hard disk drives when creating a RAID 1 set.



8. When creating a RAID_1 set, select **DWC** from the **Logical Drive** menu, then press <Enter>.
When creating a RAID_0 set, proceed to step 10.
9. Select **On** to enable the **Disk Write Cache** setting, then press <Enter>.

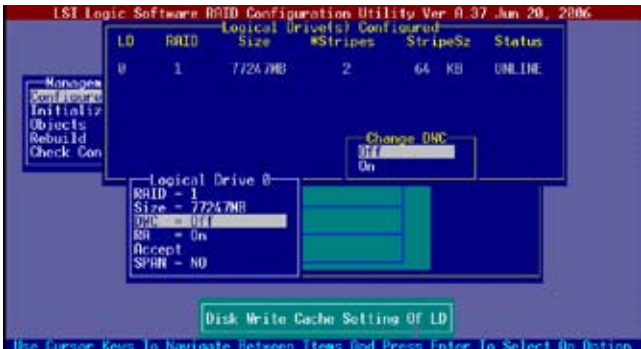

Enabling DWC can improve the performance, but with the risk of data loss.

- When finished setting the selected logical drive configuration, select **Accept** from the menu, then press <Enter>.

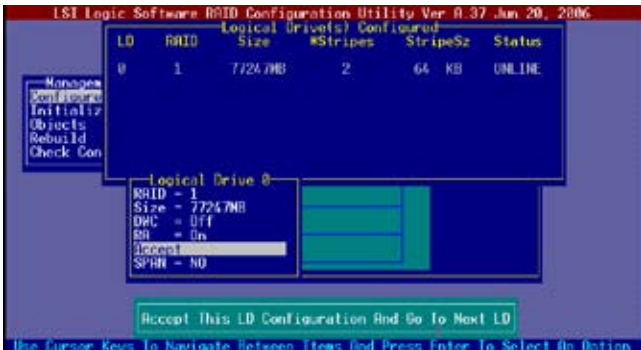

- When finished setting the selected logical drive configuration, select **Accept** from the menu, then press <Enter>.
- Follow steps 5 to 10 to configure additional logical drives.
- When prompted, save the configuration, then press <Esc> to return to the **Management Menu**.



Using New Configuration



When a RAID set is already existing, using the **New Configuration** command erases the existing RAID configuration data. If you do not want to delete the existing RAID set, use the **View/Add Configuration** command to view or create another RAID configuration.

To create a RAID set using the New Configuration option:

1. From the utility main menu, highlight **Configure**, then press <Enter>.
2. Use the arrow keys to select **New Configuration**, then press <Enter>.



3. Follow steps 3 to 7 of the previous section.
4. Select **Size** from the **Logical Drive** menu, then press <Enter>.
5. Key-in the desired logical drive size, then press <Enter>.



6. Follow steps 8 to 13 of the previous section to create the RAID set.

5.2.2 Creating a RAID 10 set

You can create a RAID 10 set using four identical hard disk drives.

To create a RAID 10 set using the Easy Configuration option:

1. From the utility main menu, highlight **Configure**, then press <Enter>.
2. Use the arrow keys to select **Easy Configuration**, then press <Enter>.



3. The **ARRAY SELECTION MENU** displays the available drives connected to the SATA ports. Select the drive(s) you want to include in the RAID set, then press <SpaceBar>. When selected, the drive indicator changes from **READY** to **ONLIN A[X]-[Y]**, where X is the array number, and Y is the drive number.

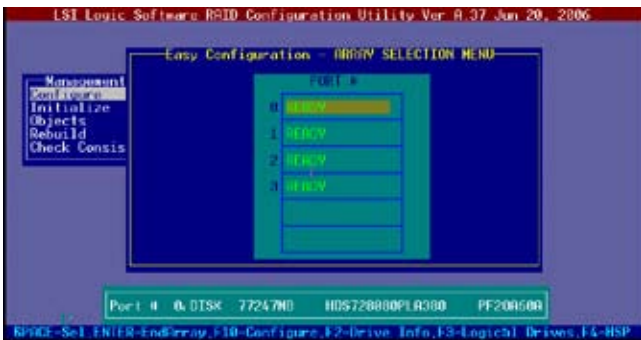

The information of the selected hard disk drive displays at the bottom of the screen.

4. Select all the drives required for the RAID 10 set, then press <Enter>. The configurable array appears on screen.

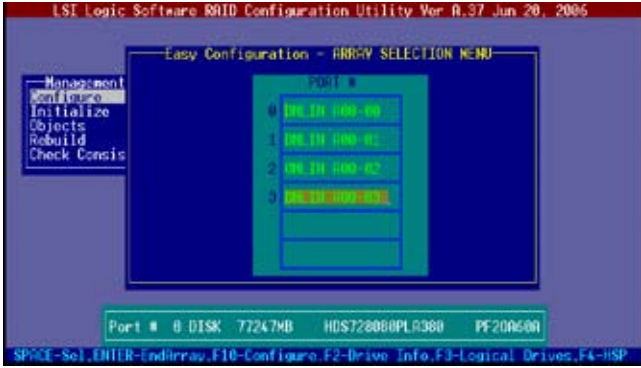

5. Press <F10>, select the configurable array, then press <SpaceBar>.



Press <F10> again, the logical drive information appears including a **Logical Drive** menu that allows you to change the logical drive parameters.

6. Select **RAID** from the **Logical Drive** menu, then press <Enter>.
7. Select **RAID 10** from the menu, then press <Enter>.



You need at least four identical hard disk drives when creating a RAID 10 set.

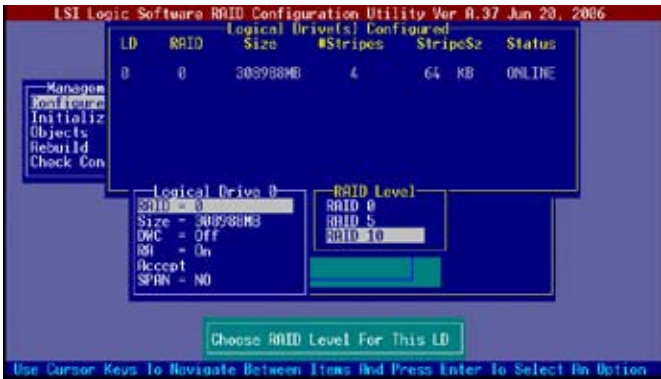

8. Select **DWC** from the **Logical Drive** menu, then press <Enter>.
9. Select **On** to enable the **Disk Write Cache** setting, then press <Enter>.

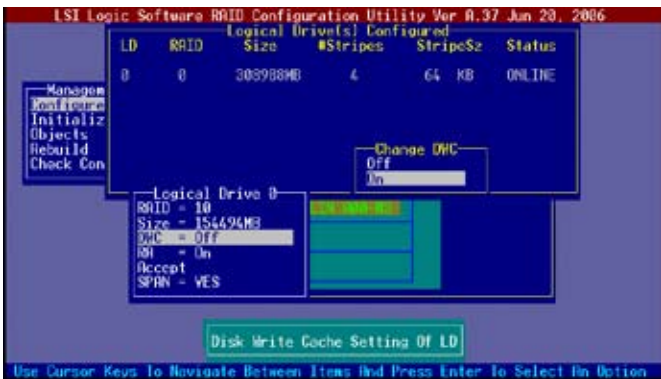

10. When finished setting the selected logical drive configuration, select **Accept** from the menu, then press <Enter>.

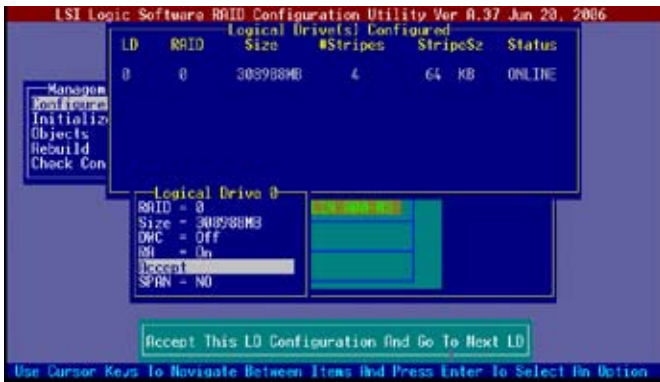

11. When prompted, save the configuration, then press <Esc> to return to the **Management Menu**.



4. Select all the drives required for the RAID set, then press <Enter>. The configurable array appears on screen.

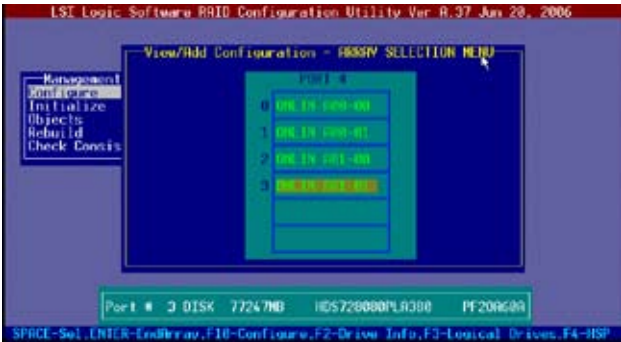

5. Press <F10>, select the configurable array, then press <SpaceBar>.

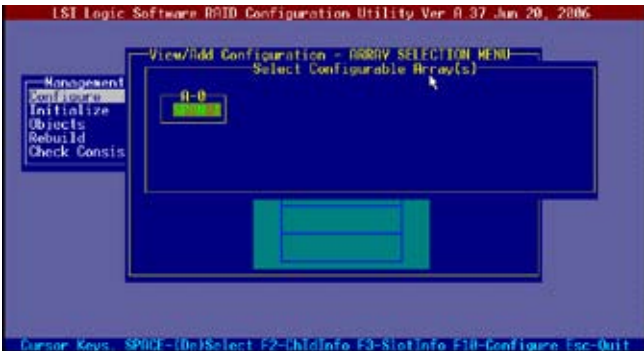

6. Press <F10> again, and select **RAID** from the **Logical Drive** menu, then press <Enter>.
7. Select the RAID level from the menu, then press <Enter>.

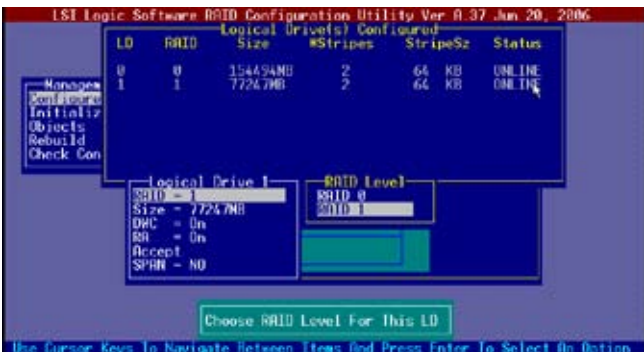

8. Follow steps 8 to 12 of the **Creating a RAID set: Using Easy Configuration** section.
9. When prompted, save the configuration, then press <Esc> to return to the **Management Menu**.



10. Follow steps 8 to 13 of the **Creating a RAID set: Using Easy Configuration** section to add the new RAID configuration.

5.2.4 Initializing the logical drives

After creating the RAID set(s), you must initialize the logical drives. You may initialize the logical drives of a RAID set(s) using the **Initialize** or **Objects** command on the **Management Menu**.

Using the Initialize command

To initialize the logical drive using the Initialize command:

1. From the **Management Menu**, highlight **Initialize**, then press <Enter>.



2. The screen displays the available RAID set(s) and prompts you to select the logical drive to initialize. Use the arrow keys to select the logical drive from the **Logical Drive** selection, then press <Enter>.



- When prompted, press the <SpaceBar> to select **Yes** from the **Initialize?** dialog box, then press <Enter>. You may also press <F10> to initialize the drive without confirmation.

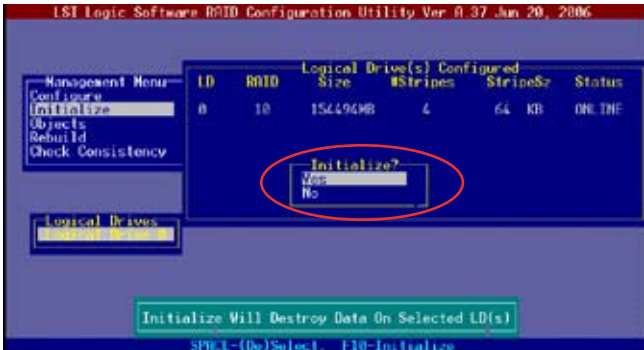

Initializing a logical drive(s) erases all data on the drive.

- A progress bar appears on screen. If desired, press <Esc> to abort initialization.



- When initialization is completed, press <Esc>.



Using the Objects command

To initialize the logical drives using the **Objects** command:

- From the **Management Menu**, highlight **Objects**, then press <Enter>.



2. Select **Logical Drive** from the **Objects** sub-menu, then press <Enter>.

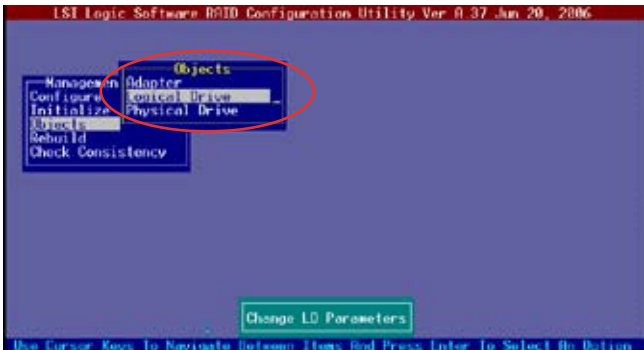

3. Select the logical drive to initialize from the **Logical Drives** sub-menu, then press <Enter>.



4. Select **Initialize** from the pop-up menu, then press <Enter> to start initialization.

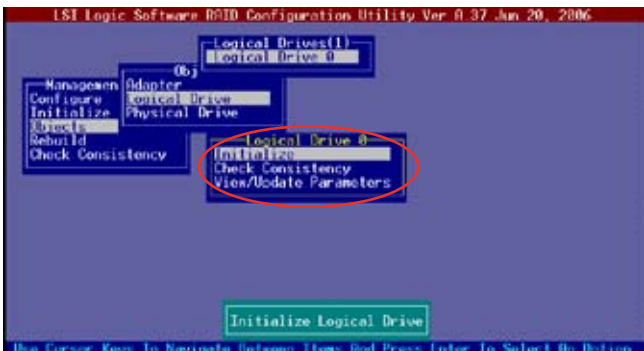

5. When prompted, press the <SpaceBar> to select **Yes** from the **Initialize?** dialog box, then press <Enter>.

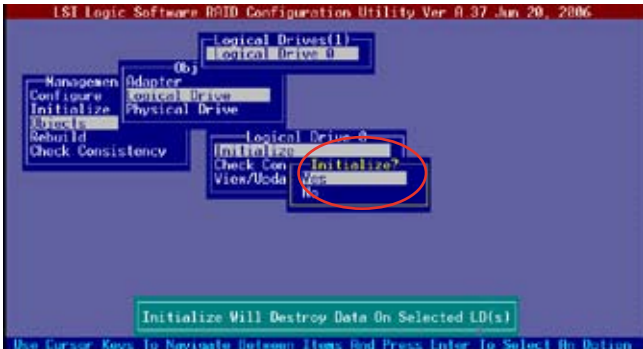

6. A progress bar appears on screen. If desired, press <Esc> to abort initialization.



7. When initialization is completed, press <Esc>.



5.2.5 Rebuilding failed drives

You can manually rebuild failed hard disk drives using the **Rebuild** command in the Management Menu.

To rebuild a failed hard disk drive:

1. From the **Management Menu**, highlight **Rebuild**, then press <Enter>.



2. The **PHYSICAL DRIVES SELECTION MENU** displays the available drives connected to the SATA ports. Select the drive you want to rebuild, then press <SpaceBar>.

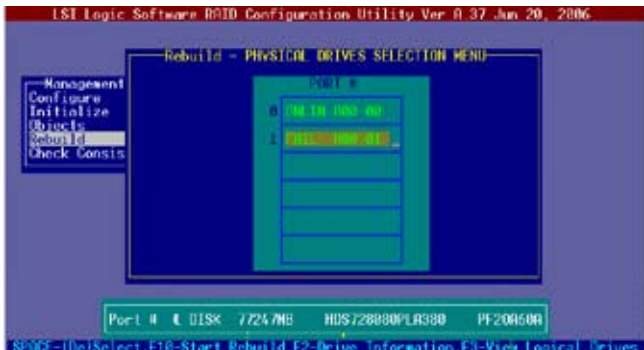

- After selecting the drive to rebuild, press <F10>. The indicator for the selected drive now shows **RBLD**.



- When prompted, press <Y> to to rebuild the drive.

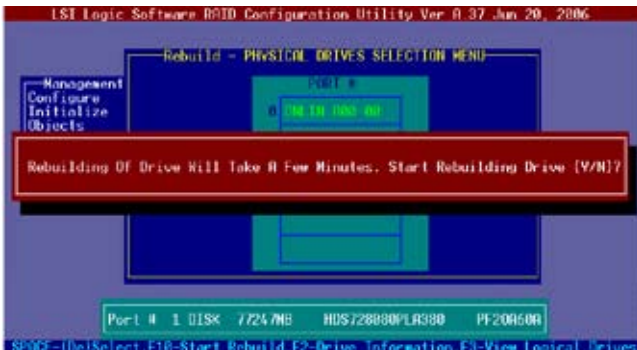

- When rebuild is complete, press any key to continue.

5.2.6 Checking the drives for data consistency

You can check and verify the accuracy of data redundancy in the selected logical drive. The utility can automatically detect and/or detect and correct any differences in data redundancy depending on the selected option in the **Objects > Adapter** menu.



The **Check Consistency** command is available only for logical drives included in a RAID 1 set.

Using the Check Consistency

To check data consistency using the **Check Consistency** command:

1. From the **Management Menu**, select **Check Consistency**, then press <Enter>.



2. The screen displays the available RAID set(s) and prompts you to select the logical drive to check. Press the <Spacebar> to select the logical drive from the **Logical Drive** selection, then press <F10>.



3. When prompted, use the arrow keys to select **Yes** from the **Consistency Check** dialog box, then press <Enter>. You may also press <F10> to check the drive consistency.

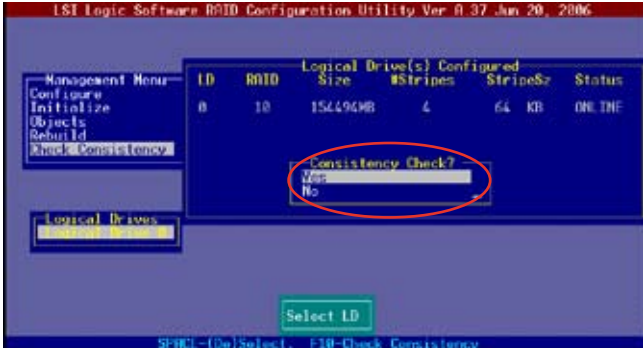

A progress bar appears on screen.



4. While checking the disk consistency, press <Esc> to display the following options.
- **Stop** - Stops the consistency check. The utility stores the percentage of disk checked, When you restart checking, it continues from the last percentage completed rather than from zero percent.
 - **Continue** - Continues the consistency check.
 - **Abort** - Aborts the consistency check. When you restart checking, it continues from zero percent.
5. When checking is complete, press any key to continue.

Using the Objects command

To check data consistency using the **Objects** command:

1. From the **Management Menu**, select **Objects**, then select **Logical Drive** from the menu.
2. Use the arrow keys to select the logical drive you want to check, then press <Enter>.
3. Select **Check Consistency** from the pop-up menu, then press <Enter>.
4. When prompted, use the arrow keys to select **Yes** from the dialog box to check the drive.
5. When checking is complete, press any key to continue.

5.2.7 Deleting a RAID configuration

To delete a RAID configuration:

1. From the **Management Menu**, select **Configure > Clear Configuration**, then press <Enter>.



2. When prompted, use the arrow keys to select **Yes** from the **Clear Configuration?** dialog box, then press <Enter>.



The utility clears the current array.

3. Press any key to continue.

5.2.8 Selecting the boot drive from a RAID set

You must have created a new RAID configuration before you can select the boot drive from a RAID set. Refer to the **Creating a RAID set: Using New Configuration** section for details.

To select the boot drive from a RAID set:

1. From the **Management Menu**, select **Configure > Select Boot Drive**, then press <Enter>.



2. When prompted, use the arrow keys to select the bootable logical drive from the list, then press <Enter>.



3. The logical drive is selected as boot drive. Press any key to continue.

5.2.9 Enabling the WriteCache

You may enable the RAID controller's WriteCache option to improve the data transmission performance.



When you enable **WriteCache**, you may lose data when a power interruption occurs while transmitting or exchanging data among the drives.

To enable WriteCache:

1. From the **Management Menu**, select **Objects > Adapter**, then press <Enter> to display the adapter properties.
2. Select **WriteCache**, then press <Enter> to turn the option **On** (enabled).



3. When finished, press any key to continue.

5.3 Intel® Matrix Storage Manager Option ROM Utility

The Intel® Matrix Storage Manager Option ROM utility allows you to create RAID 0, RAID 1, RAID 0+1, and RAID 5 set(s) from Serial ATA hard disk drives.

To enter the Intel® Matrix Storage Manager Option ROM Utility:

1. Turn on the system after installing all Serial ATA hard disk drives.
2. During POST, press <Ctrl+I> to display the utility main menu.

```
Intel(R) Matrix Storage Manager Option ROM v5.6.2.1002 ESB2 wRAID5
Copyright(C) 2003-05 Intel Corporation. All Rights Reserved.

[ MAIN MENU ]
1. Create RAID Volume
2. Delete RAID Volume
3. Reset Disks to Non-RAID
4. Exit

[ DISK/VOLUME INFORMATION ]
RAID Volumes:
None defined.

Physical Disks:
Port    Drive Model    Serial #    Size    Type/Status (Vol ID)
0       XXXXXXXXXXXX   XXXXXXXXX  XX.XXGB Non-RAID Disk
1       XXXXXXXXXXXX   XXXXXXXXX  XX.XXGB Non-RAID Disk
2       XXXXXXXXXXXX   XXXXXXXXX  XX.XXGB Non-RAID Disk
3       XXXXXXXXXXXX   XXXXXXXXX  XX.XXGB Non-RAID Disk

[↑↓]-Select  [ESC]-Exit  [ENTER]-Select Menu
```

The navigation keys at the bottom of the screen allow you to move through the menus and select the menu options.



The RAID setup screens shown in this section are for reference only and may not exactly match the items on your screen due to the controller version difference.



The utility supports maximum four hard disk drives for RAID configuration.

5.3.1 Creating a RAID 0 set (Stripe)

To create a RAID 0 set:

1. From the utility main menu, select **1. Create RAID Volume**, then press <Enter>. This screen appears.

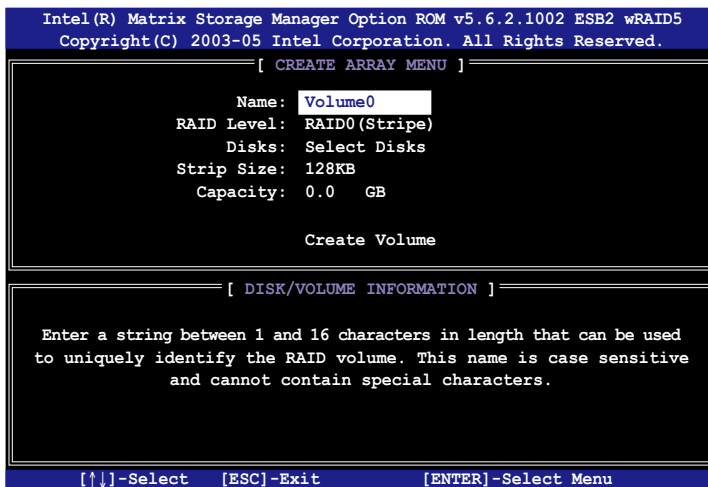

2. Enter a name for the RAID 0 set, then press <Enter>.
3. Highlight **RAID Level**, press the up/down arrow key to select **RAID 0 (Stripe)**, then press <Enter>.
4. Highlight the **Disks** item, then press <Enter> to select the hard disk drives you want to include in the RAID set. The **SELECT DISKS** screen appears.

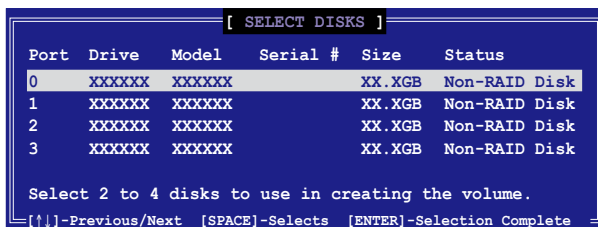

5. Use the up/down arrow key to highlight a drive, then press <Spacebar> to select. A small triangle marks the selected drive. Press <Enter> after completing your selection.

6. Use the up/down arrow key to select the stripe size for the RAID 0 array, then press <Enter>. The available stripe size values range from 4 KB to 128 KB. The default stripe size is 128 KB.



A lower stripe size is recommended for server systems. A higher stripe size is recommended for multimedia computer systems used mainly for audio and video editing.

7. Highlight the **Capacity** item, enter the desired RAID volume capacity, then press <Enter>. The default value indicates the maximum allowed capacity.
8. When the **Create Volume** item is highlighted, press <Enter>. A warning message appears.

```
WARNING: ALL DATA ON SELECTED DISKS WILL BE LOST.  
Are you sure you want to create this volume? (Y/N) :
```

9. Press <Y> to create the RAID volume and return to the main menu, or <N> to go back to the **Create Array** menu.

5.3.2 Creating a RAID 1 set (Mirror)

To create a RAID 1 set:

1. From the utility main menu, select **1. Create RAID Volume**, then press <Enter>. This screen appears.

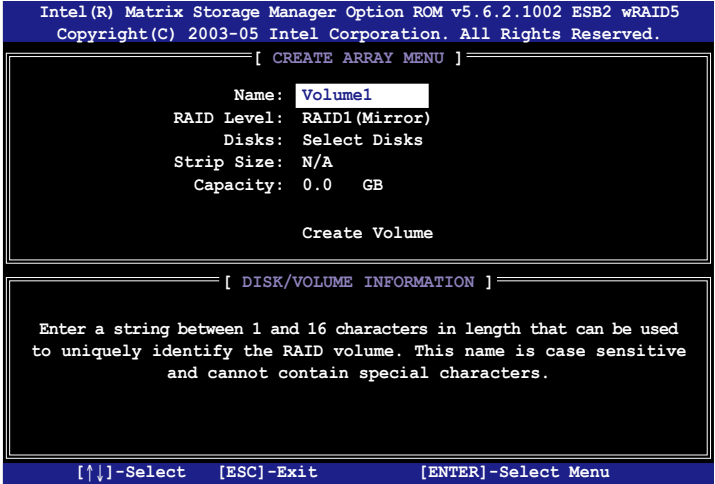

2. Enter a name for the RAID 1 set, then press <Enter>.
3. Highlight **RAID Level**, press the up/down arrow key to select **RAID 1 (Mirror)**, then press <Enter>.
4. Follow steps 4 to 5 and 7 to 9 of the previous section to create the RAID 1 set.

5.3.3 Creating a RAID 10 set (Stripe + Mirror)

To create a RAID 10 set:

1. From the utility main menu, select **1. Create RAID Volume**, then press <Enter>. This screen appears.

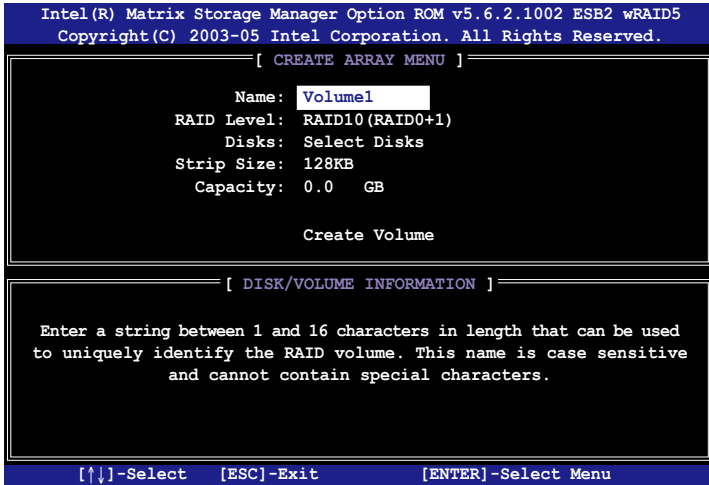

2. Enter a name for the RAID 10 set, then press <Enter>.
3. Highlight **RAID Level**, press the up/down arrow key to select **RAID 10 (RAID0+1)**, then press <Enter>.
4. Follow steps 4 to 9 of section **5.3.1 Creating a RAID 0 set (striped)** to create the RAID 10 set.

5.3.4 Creating a RAID 5 set (Parity)

To create a RAID 5 set:

1. From the utility main menu, select **1. Create RAID Volume**, then press <Enter>. This screen appears.

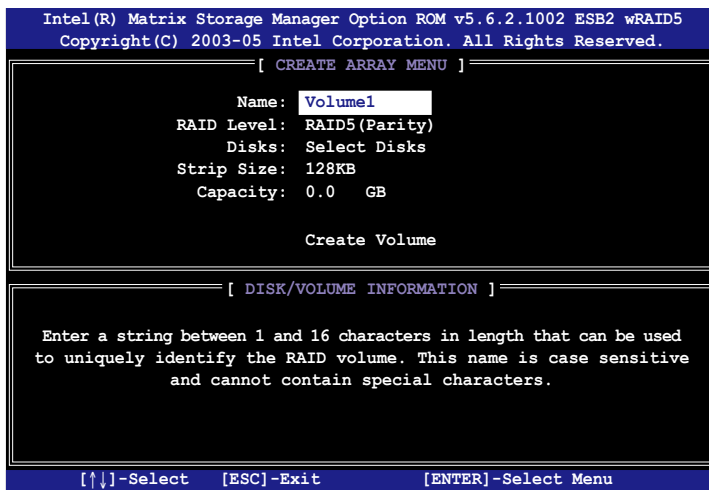

2. Enter a name for the RAID 10 set, then press <Enter>.
3. Highlight **RAID Level**, press the up/down arrow key to select **RAID5**, then press <Enter>.
4. Follow steps 4 to 9 of section **5.3.1 Creating a RAID 0 set (striped)** to create the RAID 5 set.

5.3.5 Deleting a RAID set



Take caution when deleting a RAID set. You will lose all data on the hard disk drives when you delete a RAID set.

To delete a RAID set:

1. From the utility main menu, select **2. Delete RAID Volume**, then press <Enter> to display this screen.

```
Intel(R) Matrix Storage Manager Option ROM v5.6.2.1002 ESB2 wRAID5
Copyright(C) 2003-05 Intel Corporation. All Rights Reserved.

[ DELETE VOLUME MENU ]
-----
Name      Level      Drives      Capacity    Status    Bootable
-----
Volume0   RAIDX(XXXXX) X           XXX.XGB    Normal    Yes

[ HELP ]

Deleting a volume will destroy the volume data on the drive(s) and
cause any member disks to become available as non-RAID disks.

WARNING: EXISTING DATA WITHIN THIS VOLUME WILL BE LOST AND
NON-RECOVERABLE.

[↑↓]-Select      [ESC]-Previous Menu      [Del]-Delete Volume
```

2. Use the up/down arrow key to select the RAID set you want to delete, then press . This window appears.

```
[ DELETE VOLUME VERIFICATION ]

ALL DATA IN THE VOLUME WILL BE LOST!
Are you sure you want to delete volume "VolumeX"? (Y/N) :
```

3. Press <Y> to delete the RAID set and return to the utility main menu; otherwise, press <N> to return to the **Delete Volume** menu.

5.3.6 Resetting disks to Non-RAID



Take caution before you reset a RAID volume hard disk drive to non-RAID. Resetting a RAID volume hard disk drive deletes all internal RAID structure on the drive.

To reset a RAID set hard disk drive:

1. From the utility main menu, select **3. Reset Disks to Non-RAID**, then press <Enter> to display this screen.

```
[ RESET RAID DATA ]

Resetting RAID data will remove internal RAID structures
from the selected RAID disks. By removing these structures,
the drive will revert back to a non-RAID disk.

WARNING: Resetting a disk causes all data on the disk to
be lost.

Port  Drive Model      Serial #      Size  Status
---  -
0     XXXXXXXXXXXXX  XXXXXXXX    XX.XGB Member Disk
1     XXXXXXXXXXXXX  XXXXXXXX    XX.XGB Member Disk

Select the disks that should be reset.

[↑↓]-Previous/Next [SPACE]-Selects [ENTER]-Selection Complete
```

2. Use the up/down arrow key to highlight the RAID set drive you want to reset, then press <Spacebar> to select.
3. Press <Enter> to reset the RAID set drive. A confirmation message appears.
4. Press <Y> to reset the drive or press <N> to return to the utility main menu.
5. Follow steps 2 to 4 to select and reset other RAID set drives.

5.3.7 Exiting the Intel® Matrix Storage Manager

To exit the utility:

1. From the utility main menu, select **4. Exit**, then press <Enter>. This window appears.

```
[ CONFIRM EXIT ]

Are you sure you want to exit? (Y/N):
```

2. Press <Y> to exit or press <N> to return to the utility main menu.

5.4 Global Array Manager

You may also create a RAID set(s) in Windows® operating environment using the Global Array Manager (GAM) application. The GAM application is available from the motherboard support CD.



Refer to the GAM user guide in the motherboard support CD for details.

5.5 Marvell® 88SE6145 RAID BIOS configuration utility (DSEB-DG model only)

The Marvell® 88SE6145 RAID BIOS Configuration utility allows you to create RAID 0, RAID 1, RAID 10, and RAID 5 set(s) from Serial ATA hard disk drives that are connected to the Serial ATA connectors supported by the Southbridge.

To enter the Marvell® RAID BIOS Configuration utility:

1. Install all the Serial ATA hard disk drives at Red SATA Connector.
2. Turn on the system.
3. During POST, press <Ctrl> + <M> to enter the utility main menu.

```
ENTER/SPACE>Select, ESC:Back/Exit
[Adapter] [Create] [Delete]
Adapter 1
Arrays Information:
  No array is defined!

Disks Information:
ID Port  Disk Name                Size  Speed  Status
0  0     SATA: Hitachi HDS721010KLA330  1TB   SATA II  FREE
4  1     SATA: Hitachi HDS721010KLA330  1TB   SATA II  FREE
8  2     SATA: Hitachi HDS721010KLA330  1TB   SATA II  FREE
12 3     SATA: Hitachi HDS721010KLA330  1TB   SATA II  FREE

Marvell BIOS Setup (c) 2006 Marvell Technology, Ltd.
```

4. Press <Enter> and select a desired adapter for RAID configuration.

```
ENTER/SPACE>Select, ESC:Back/Exit
[Adapter] [Create] [Delete]
Select Adapter
Adapter 1
Adapter 2

Marvell BIOS Setup (c) 2006 Marvell Technology, Ltd.
```



The RAID BIOS setup screens shown in this section are for reference only and may not exactly match the items on your screen.

5.5.1 Creating a RAID set (RAID 0, RAID 1, RAID 10, or RAID 5)

To create a RAID set:

1. From the utility menu bar, select **Create** on the top.

```
ENTER/SPACE>Select, ESC:Back/Exit
[Adapter] [Create] [Delete]
Adapter 1
Arrays Information:
  No array is defined!

Disks Information:
ID Port  Disk Name                               Size  Speed  Status
0  0    SATA: Hitachi HDS721010KLA330             1TB   SATA II  FREE
4  1    SATA: Hitachi HDS721010KLA330             1TB   SATA II  FREE
8  2    SATA: Hitachi HDS721010KLA330             1TB   SATA II  FREE
12 3    SATA: Hitachi HDS721010KLA330             1TB   SATA II  FREE

Marvell BIOS Setup (c) 2006 Marvell Technology, Ltd.
```

2. Press <Enter>. The screen shows the disks you can add to make up the RAID set. Use the arrow key to select a disk and press <Enter> or <Space> to include this disk in the array.

```
ENTER/SPACE>Select, ESC:Back/Exit
[Adapter] [Create] [Delete]
Select free disks to create
ID Port  Disk Name                               Size  Speed  Status
0  0    SATA: Hitachi HDS721010KLA330             1TB   SATA II  FREE
4  1    SATA: Hitachi HDS721010KLA330             1TB   SATA II  FREE
8  2    SATA: Hitachi HDS721010KLA330             1TB   SATA II  FREE
12 3    SATA: Hitachi HDS721010KLA330             1TB   SATA II  FREE
NEXT

Marvell BIOS Setup (c) 2006 Marvell Technology, Ltd.
```

3. After you have selected the desired disks, select **NEXT** to create array.

4. The **Create Array** screen appears.

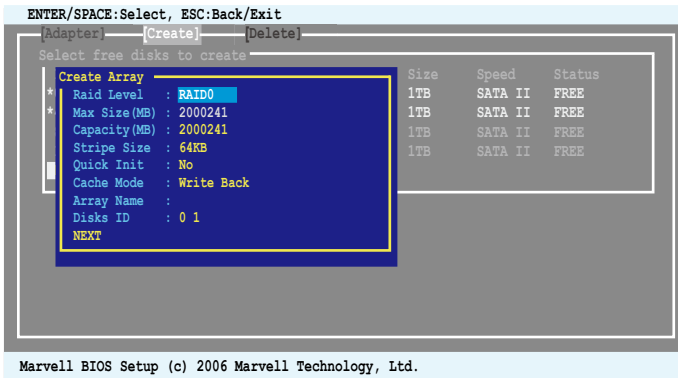

5. Use the arrow key to select the **RAID Level** item and press <Enter> to display the available RAID set. Select a RAID set and press <Enter> to create.

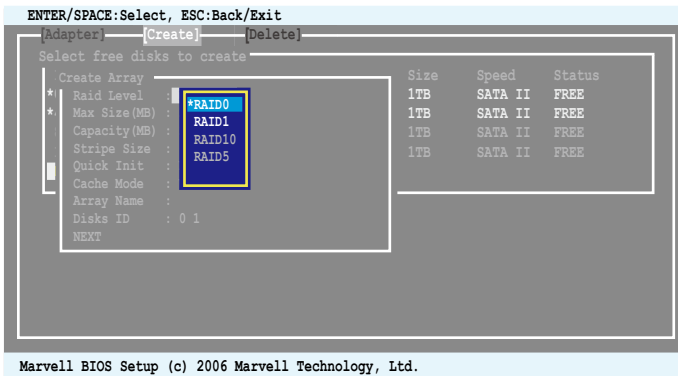

- The available RAID sets vary with the number of disks you select. The RAID sets that you are not allowed to create are grayed out.
- Except for the **RAID Level** item, we recommend you keep the default values for the other items in **Create Array** screen.

6. A confirmation screen appears. Press <Y> to confirm the array creation.

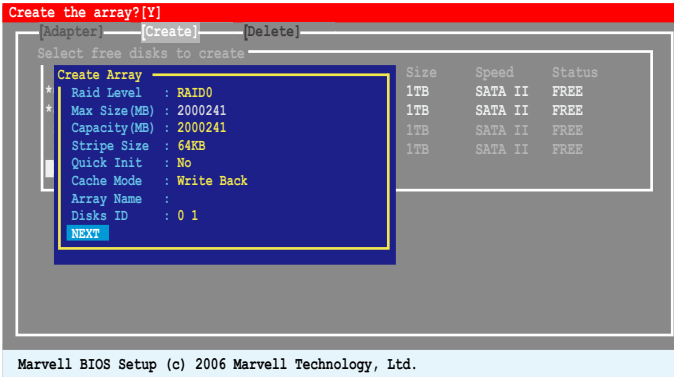

7. The newly created array appears in **Arrays Information**.

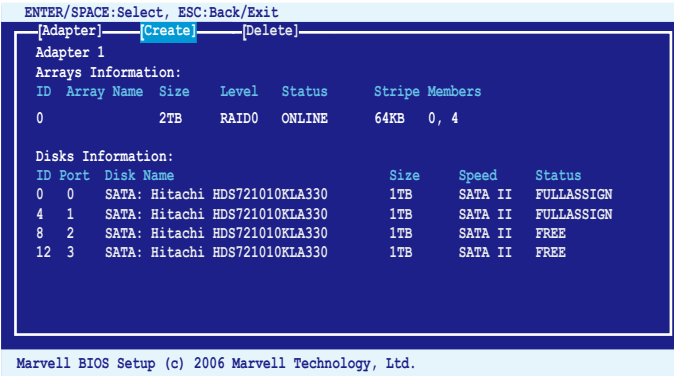

5.5.2 Deleting an array

To delete a RAID set:

1. From the utility menu bar, select **Delete** on the top and press <Enter> and the **Delete array** screen appears.

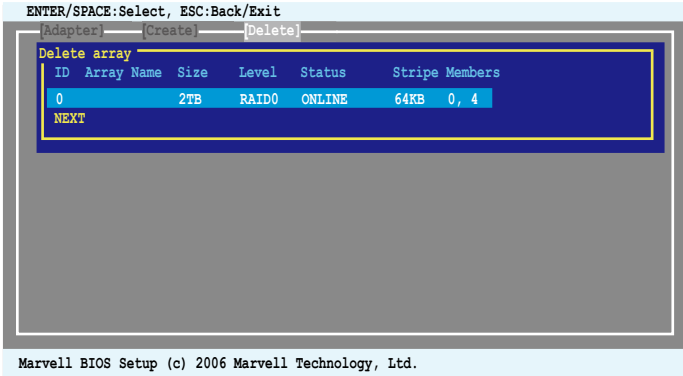

2. Select a desired array to delete and select **NEXT**. Press <Y> after the confirmation screen appears.

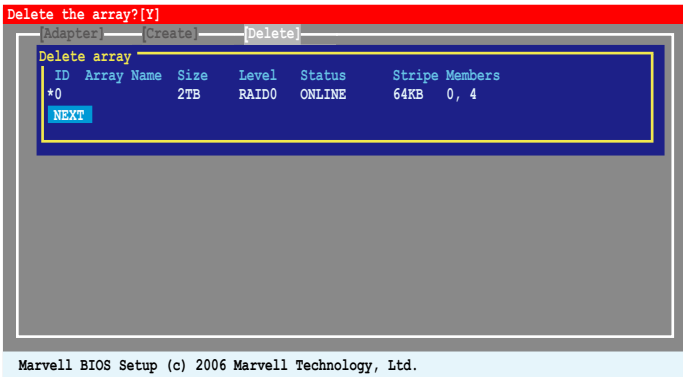

3. Press <Y> again to confirm and delete the selected array.

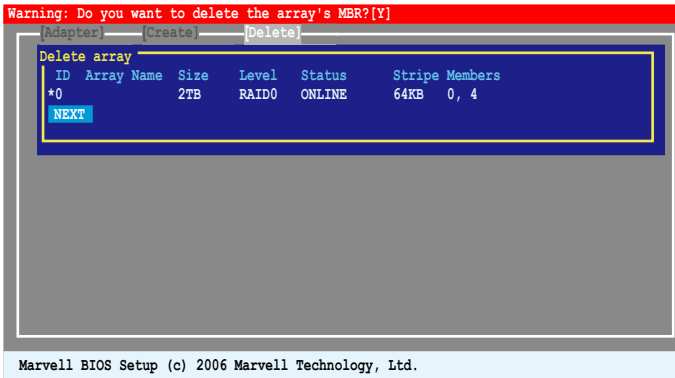

You cannot recover lost data if you delete an array. Make sure you back up important data before deleting an array.

5.6 LSI Logic MPT Setup Utility (DSEB-DG/SAS model only)

The LSI Logic MPT Setup Utility is an integrated RAID solution that allows you to create the following RAID set(s) from SAS hard disk drives supported by the LSI1068 PCI-X SAS controller:

- RAID 1 (Integrated Mirroring)
- RAID 1E (Integrated Mirroring Enhanced)
- RAID 0 (Integrated Striping)

5.6.1 Integrated Mirroring

Overview

The Integrated Mirroring (IM) feature supports simultaneous mirrored volumes with two disks (IM). Integrated Mirroring Enhanced (IME) supports three to eight disks, or seven mirrored disks plus a hot spare disk.

The IM feature supports hot swap capability, so when a disk in an IM volume fails, you can easily restore the volume, and the swapped disk is automatically re-mirrored.

Creating Integrated Mirroring volumes



-
- You may use disks of different sized in IM and IME volumes; however, the size of the smallest disk determines the "logical" size of each mirrored disk.
 - DO NOT combine Serial ATA and SAS disk drives in one volume.
 - The RAID setup screens shown in this section are for reference only and may not exactly match the items on your screen due to the controller version difference.
-

To create an IM volume:

1. Turn on the system after installing all SAS hard disk drives.
2. During POST, press <Ctrl+C> to enter the SAS configuration utility.

```
LSI Logic Corp. MPT SAS BIOS
MPTBIOS-6.16.00.00 (2007.05.07)
Copyright 2000-2007 LSI Logic Corp.

Adapter(s) disabled by user
Press Ctrl-C to start LSI Logic Configuration Utility...
```

- The following screen appears. Select a channel and press <Enter> to enter the setup.

```

LSI Logic Config Utility          v6.16.00.00 (2007.05.07)
Adapter List  Global Properties
Adapter      PCI      PCI      PCI      PCI      FW Revision      Status      Boot
              Bus      Dev      Func     Slot
SAS1068      05      03      00      00      1.15.00.00-IR   Disabled    0
  
```

Esc = Exit Menu F1/Shift+1 = Help
 Alt+N = Global Properties +/- = Alter Boot Order Ins/Del = Alter Boot List



The numbers of the channel depend on the controller.

- The **Adapter Properties** screen appears. Use the arrow keys to select **RAID Properties**, then press <Enter>.

```

LSI Logic Config Utility          v6.16.00.00 (2007.05.07)
Adapter Properties -- SAS1068
Adapter      SAS1068
PCI Slot      00
PCI Address(Bus/Dev/Func)  05.03.00
MPT Firmware Revision  1.15.00.00-IR
SAS Address     500E0180:60831008
NVIDIA Version   25.02
Status          Disabled
Boot Order      0
Boot Support     Enabled BIOS & OS
  
```

RAID Properties
 SAS Topology
 Advanced Adapter Properties

Esc = Exit Menu F1/Shift+1 = Help
 Enter = Select Item +/- = Change Item

- The **Select New Array Type** screen appears. Use the arrow keys to select **Create IM Volume**, then press <Enter>.

```

LSI Logic Config Utility          v6.16.00.00 (2007.05.07)
Select New Array Type -- SAS1068
  
```

Create IM Volume Create Integrated Mirror Array of 2 disks plus an optional hot spare. Data on the primary disk may be migrated.

Create IME Volume Create Integrated Mirrored Enhanced Array of 3 to 8 disks including an optional hot spare. ALL DATA on array disks will be DELETED!

Create IS Volume Create Integrated Striping array of 2 to 8 disks. ALL DATA on array disks will be DELETED!

Esc = Exit Menu F1/Shift+1 = Help
 Enter = Choose array type to create

6. The Create New Array screen shows the disks you can add to make up the IM volume. Use the arrow key to select a disk, then move the cursor to the RAID Disk column. To include this disk in the array, press <+>, <->, or <Space>.

You may also specify the Hot Spare disk here. Select the disk, then move the cursor to the Hot Spr column, then press <+>, <->, or <Space>.

```
LSI Logic Config Utility          v6.16.00.00 (2007.05.07)
Create New Array -- SAS1068

Array Type:                        IM
Array Size (MB):                    -----

Slot  Device Identifier            RAID  Hot  Drive  Pred  Size
Num   Device Identifier            Disk  Spr  Status Fail  (MB)
-----
0     SEAGATE ST373454SS            0003  [NO] [NO]  -----  ---  70007
1     SEAGATE ST373454SS            0003  [NO] [NO]  -----  ---  70007
2     SEAGATE ST373454SS            0003  [NO] [NO]  -----  ---  35003
3     SEAGATE ST373454SS            0003  [NO] [NO]  -----  ---  35003

Esc = Exit Menu    F1/Shift+1 = Help
SPACE/+/- = Select disk for array or hot spare    C = Create array
```



By default, the RAID Disk field shows No before array creation. This field is grayed out under the following conditions:

- The disk does not meet the minimum requirements for use in a RAID array.
- The disk is not large enough to mirror existing data on the primary drive.
- The disk has been selected as the Hot Spare for the RAID array.
- The disk is already part of another array.

7. A confirmation screen appears.

Press <M> to keep existing data on the first disk. If you choose this option, data on the first disk will be mirrored on the second disk that you will add to the volume later. Make sure the data you want to mirror is on the first disk.

Press <D> to overwrite any data and create the new IM array.

```
LSI Logic Config Utility          v6.16.00.00 (2007.05.07)
Create New Array Type -- SAS1068

M - Keep existing data, migrate to an IM array.
    Synchronization of disk will occur.

D - Overwrite existing data, create a new IM array.
    ALL DATA on ALL disk in the array will be DELETED!!
    No Synchronization performed.

Esc = Exit Menu      F1/Shift+F1 = Help
Space/+/- = Select disk for array or hot spare  C = Create array
```

8. Repeat steps 5 and 6 to add the second disk to the volume.
9. When done, press <C> to create the array, then select Save changes then exit this menu.

```
Create and save new array?
Cancel Exit
Save changes then exit this menu
Discard changes then exit this menu
Exit the Configuration Utility and Reboot
```

10. The utility creates the array.

```
LSI Logic Config Utility          v6.16.00.00 (2007.05.07)

Processing...may take up 1 minute
Creating RAID array
```

5.6.2 Integrated Mirroring Enhanced

To create an IME volume:

1. The **Adapter Properties** screen appears.
Use the arrow keys to select **RAID Properties**, then press <Enter>.

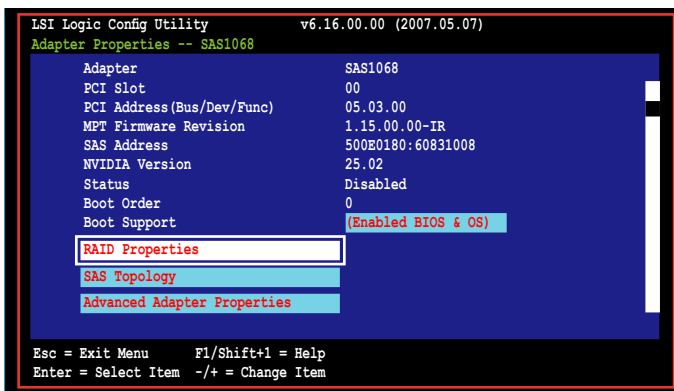

2. The **Select New Array Type** screen appears.
Use the arrow keys to select **Create IME Volume**, then press <Enter>.

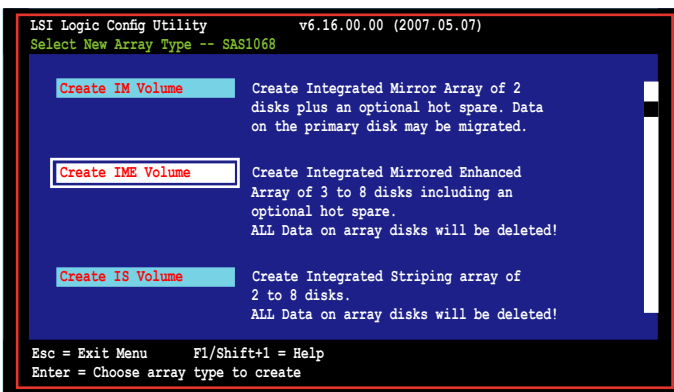

- The **Create New Array** screen shows the disks you can add to make up the IME volume.

Integrated Mirroring Enhanced (IME) supports three to eight disks, or seven mirrored disks plus a hot spare disk. Use the arrow key to select a disk, then move the cursor to the RAID Disk column. To include this disk in the array, press <+>, <->, or <Space>.

You may also specify the Hot Spare disk here. Select the disk, then move the cursor to the Hot Spr column, then press <+>, <->, or <Space>.

```

LSI Logic Config Utility          v6.16.00.00 (2007.05.07)
Create New Array -- SAS1068

  Array Type:                    IME
  Array Size(MB):                51498

Slot  Device Identifier          RAID  Hot  Drive  Pred  Size
Num   Num                       Disk  Spr  Status Fail  (MB)
-----
0     SEAGATE ST373454SS         0003  [Yes] [NO]  -----  ---  70007
1     SEAGATE ST373454SS         0003  [NO]  [NO]  -----  ---  70007
2     SEAGATE ST373454SS         0003  [Yes] [NO]  -----  ---  35003
3     SEAGATE ST373454SS         0003  [Yes] [NO]  -----  ---  35003

Esc = Exit Menu    F1/Shift+1 = Help
SPACE/+/- = Select disk for array or hot spare    C = Create array
  
```



By default, the RAID Disk field shows No before array creation. This field is grayed out under the following conditions:

- The disk does not meet the minimum requirements for use in a RAID array.
- The disk is not large enough to mirror existing data on the primary drive.
- The disk has been selected as the Hot Spare for the RAID array.
- The disk is already part of another array.

- Repeat step 5 to add the other disks to the volume.
- When done, press <C> to create the array, then select Save changes then exit this menu.

```

Create and save new array?
Cancel Exit
Save changes then exit this menu
Discard changes then exit this menu
Exit the Configuration Utility and Reboot
  
```

- The utility creates the array.

```

LSI Logic Config Utility          v6.16.00.00 (2007.05.07)

Processing...may take up 1 minute
Creating RAID array
  
```

5.6.3 Integrated Striping (IS) volume

Overview

The Integrated Striping (IS) feature provides RAID 0 functionality, supporting volumes with two to eight disks. You may combine an IS volume with an IM or IME volume.

Creating Integrated Striping volumes



DO NOT combine Serial ATA and SAS disk drives in one volume.

To create an IS volume:

1. Turn on the system after installing all SAS hard disk drives.
2. During POST, press <Ctrl+C> to enter the SAS configuration utility.

```
LSI Logic Corp. MPT SAS BIOS
MPTBIOS-6.16.00.00 (2007.05.07)
Copyright 2000-2007 LSI Logic Corp.

Adapter(s) disabled by user
Press Ctrl-C to start LSI Logic Configuration Utility...
```

3. The **Adapter Properties** screen appears. Use the arrow keys to select **RAID Properties**, then press <Enter>.

```
LSI Logic Config Utility          v6.16.00.00 (2007.05.07)
Adapter Properties -- SAS1068

Adapter          SAS1068
PCI Slot         00
PCI Address (Bus/Dev/Func) 05.03.00
MPT Firmware Revision 1.15.00.00-IR
SAS Address      500E0180:60831008
NVIDIA Version   25.02
Status           Disabled
Boot Order       0
Boot Support     (Enabled BIOS & OS)

RAID Properties
SAS Topology
Advanced Adapter Properties

Esc = Exit Menu      F1/Shift+1 = Help
Enter = Select Item  -/+ = Change Item
```

4. The **Select New Array Type** screen appears.
Use the arrow keys to select **Create IS Volume**, then press <Enter>.

```

LSI Logic Config Utility          v6.16.00.00 (2007.05.07)
Select New Array Type -- SAS1068

  Create IM Volume                Create Integrated Mirror Array of 2
                                  disks plus an optional hot spare. Data
                                  on the primary disk may be migrated.

  Create IME Volume              Create Integrated Mirrored Enhanced
                                  Array of 3 to 8 disks including an
                                  optional hot spare.
                                  ALL DATA on array disks will be DELETED!

  Create IS Volume                Create Integrated Striping array of
                                  2 to 8 disks.
                                  ALL DATA on array disks will be DELETED!

Esc = Exit Menu      F1/Shift+1 = Help
Enter = Choose array type to create
  
```

5. The **Create New Array** screen shows the disks you can add to make up the IS volume. Use the arrow key to select a disk, then move the cursor to the RAID Disk column. To include this disk in the array, press <+>, <->, or <Space>.

```

LSI Logic Config Utility          v6.16.00.00 (2007.05.07)
Create New Array -- SAS1068

  Array Type:                      IS
  Array Size (MB):                 102996

Slot  Device Identifier            RAID  Hot  Drive  Pred  Size
Num   Num                       Disk  Spr  Status Fail  (MB)
-----
0     SEAGATE ST373454SS           0003  [Yes] [NO]  -----  ---  70007
1     SEAGATE ST373454SS           0003  [NO]  [NO]  -----  ---  70007
2     SEAGATE ST373454SS           0003  [Yes] [NO]  -----  ---  35003
3     SEAGATE ST373454SS           0003  [Yes] [NO]  -----  ---  35003

Esc = Exit Menu      F1/Shift+1 = Help
SPACE/+/- = Select disk for array or hot spare  C = Create array
  
```



By default, the RAID Disk field shows No before array creation. This field is grayed out under the following conditions:

- The disk does not meet the minimum requirements for use in a RAID array.
- The disk is not large enough to mirror existing data on the primary drive.
- The disk has been selected as the Hot Spare for the RAID array.
- The disk is already part of another array.

- Repeat step 5 to add the other disks to the volume.
- When done, press <C> to create the array, then select **Save changes then exit this menu**.

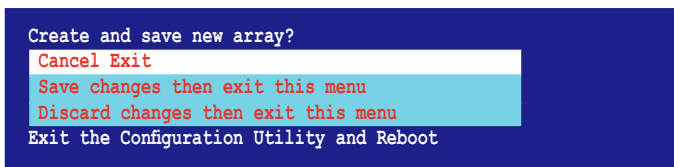

- The utility creates the array.

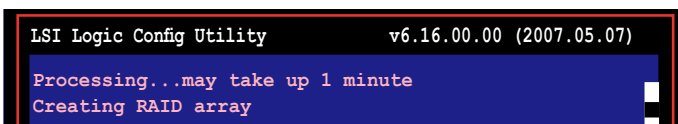

5.6.4 Managing Arrays

The LSI Logic MPT Setup Utility allows you to perform other tasks related to configuring and maintaining IM and IME volumes.

Refer to this section to view volume properties, manage the hot spare disk, synchronize the array, activate the array, and delete the array.

Viewing volume properties

To view volume properties:

1. On the main menu, select **RAID Properties**.

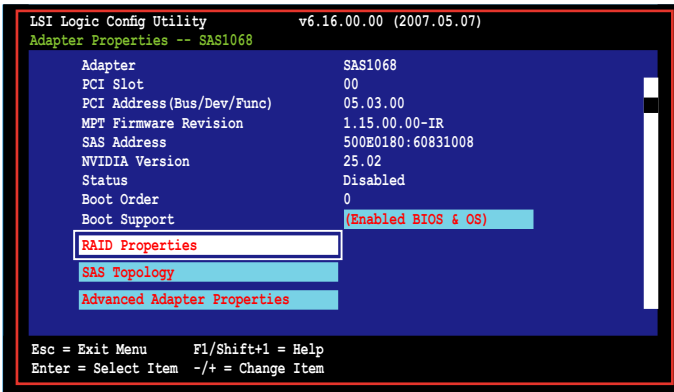

2. On the next screen that appears, select **View Existing Array**.

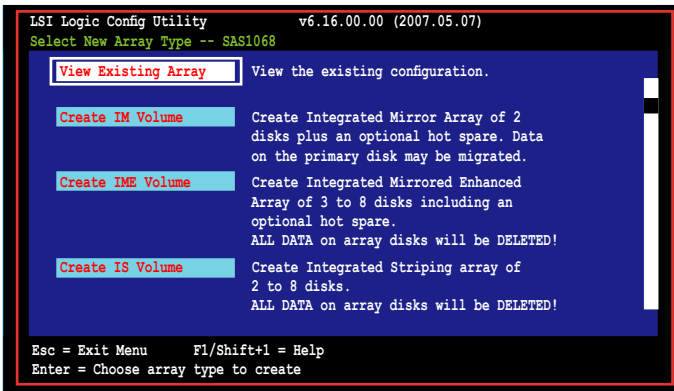

- The **View Existing Array** screen appears. Here you can view properties of the RAID array(s) created. If you have configured a hot spare, it will also be listed. If you created more than one array, you may view the next array by pressing <Alt+N>.

```

LSI Logic Config Utility                v6.16.00.00 (2007.05.07)
View Array -- SAS1068
Array 1 of 1
Identifier LSILOGICLogical Volume 3000
Type IME
Scan Order 0
Size(MB) 51498
Status Optimal

Manage Array

Slot Device Identifier RAID Hot Drive Pred Size
Num Disk Spr Status Fail (MB)
0 SEAGATE ST373454SS 0003 Yes NO Ok No 34331
2 SEAGATE ST373454SS 0003 Yes NO Ok No 34331
3 SEAGATE ST373454SS 0003 Yes NO Ok No 34331

Esc = Exit Menu F1/Shift+1 = Help
Enter=Select Item Alt+N=Next Array C = Create an array

```

Managing hot spares

You may configure one disk as a global hot spare to protect critical data on the IM/IME volume(s). You may create the hot spare disk at the same time you create the IM/IME volume. Refer to this section when adding a hot spare disk on an existing volume.



If a disk on an IM/IME volume fails, the utility automatically rebuilds the failed disk data on the hot spare. When the failed disk is replaced, the utility assigns the replacement as the new hot spare.

To create a hot spare:

1. Follow steps 1 ~ 3 of the section **Viewing volume properties**.
2. From the **View Array** screen, select **Manage Array**, then press <Enter>.

```
LSI Logic Config Utility                v6.16.00.00 (2007.05.07)
View Array -- SAS1068
Array                                  1 of 1
Identifier                             LSILOGICLogical Volume 3000
Type                                    IME
Scan Order                              0
Size (MB)                               51498
Status                                  Optimal

Manage Array

Slot  Device Identifier                RAID  Hot  Drive  Pred  Size
Num   Num                               Disk Spr Status Fail (MB)
0     0 SEAGATE ST373454SS              0003 Yes NO  Ok    No   34331
2     2 SEAGATE ST373454SS              0003 Yes NO  Ok    No   34331
3     3 SEAGATE ST373454SS              0003 Yes NO  Ok    No   34331

Esc = Exit Menu          F1/Shift+1 = Help
Enter=Select Item      Alt+N=Next Array  C = Create an array
```

3. From the **Manage Array** screen select **Manage Hot Spare**, then press <Enter>.

```
LSI Logic Config Utility                v6.16.00.00 (2007.05.07)
Manage Array -- SAS1068
Identifier                             LSILOGICLogical Volume 3000
Type                                    IME
Scan Order                              0
Size (MB)                               51498
Status                                  Optimal

Manage Hot Spare
Synchronize Array
Activate Array
Delete Array

Esc = Exit Menu          F1/Shift+1 = Help
Enter = Select Item
```

- Use the arrow key to select the disk you would like to configure as hot spare, then move the cursor to the Hot Spr column. Press <+>, <->, or <Space>. The Drive Status column field now shows Hot Spare. Press <C> to commit the changes.

```

LSI Logic Config Utility                               v6.16.00.00 (2007.05.07)
Manage Hot Spare -- SAS1068

Identifier      LSILOGICLogical Volume 3000
Type           IME
Scan Order     0
Size (MB)      51498
Status         Optimal

Slot  Device Identifier      Hot   Drive   Pred   Size
Num   Num                   Spr   Status  Fail   (MB)
0     0 SEAGATE ST373454SS      0003  [NO]   Ok     No     34331
1     1 SEAGATE ST373454SS      0003  [NO]   Ok     No     34331
2     2 SEAGATE ST373454SS      0003  [NO]   Ok     No     34331
3     3 SEAGATE ST373454SS      0003  [Yes]  Hot Spr No     35003
      [----] ----- --      ----

Esc = Exit Menu   F1/Shift+1 = Help
SPACE/+/- = Change Item   C = Commit Changes
  
```

Synchronizing the array

Synchronizing the array allows the utility to resynchronize data on the mirrored disk in the array. This procedure is seldom required because data synchronization is automatically done during normal operation.

To synchronize the array:

- Follow steps 1 ~ 3 of the section **Viewing volume properties** and step 2 of the section **Managing hot spares**.
- From the **Manage Array** screen select **Synchronize Array**, then press <Enter>.

```

LSI Logic Config Utility                               v6.16.00.00 (2007.05.07)
Manage Array -- SAS1068

Identifier      LSILOGICLogical Volume 3000
Type           IME
Scan Order     0
Size (MB)      51498
Status         Optimal

Manage Hot Spare
Synchronize Array
Activate Array
Delete Array

Esc = Exit Menu   F1/Shift+1 = Help
Enter = Select Item
  
```

- Press <Y> to begin the synchronization, or <N> to cancel.

Activating an array

If an array is removed from one controller/computer or moved to another, the array is considered inactive. When you add the array back to the system, you may reactivate the array.

To activate the array:

1. From the **Manage Array** screen, select **Activate Array**, then press <Enter>.

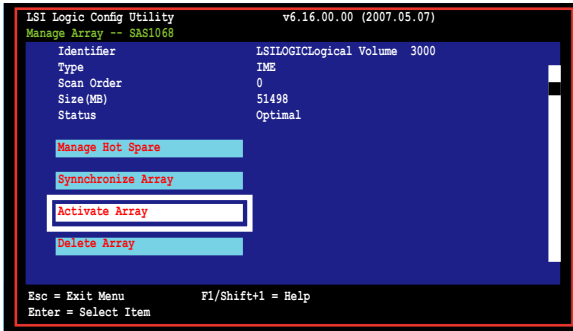

2. Press <Y> to activate, or <N> to cancel.

Deleting an array



- You cannot recover lost data if you delete an array. Make sure you back up important data before deleting an array.
- If you delete an IM (RAID 1) volume, the data is preserved on the primary disk.

To delete an array:

1. From the **Manage Array** screen, select **Delete Array**, then press <Enter>.

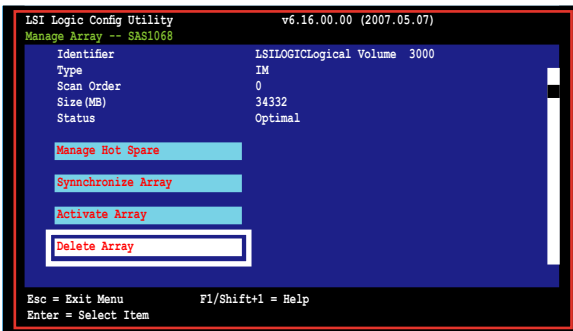

2. Press <Y> to delete, or <N> to cancel.

5.6.5 Viewing SAS topology

1. From the **Adapter Properties** screen, select **SAS Topology**.

```
LSI Logic Config Utility          v6.16.00.00 (2007.05.07)
Adapter Properties -- SAS1068

Adapter                SAS1068
PCI Slot               00
PCI Address(Bus/Dev/Func) 05.03.00
MPT Firmware Revision  1.15.00.00-IR
SAS Address            500E0180:60831008
NVIDIA Version        25.02
Status                Disabled
Boot Order             0
Boot Support           (Enabled BIOS & OS)

RAID Properties
SAS Topology
Advanced Adapter Properties

Esc = Exit Menu      F1/Shift+1 = Help
Enter = Select Item  -/+ = Change Item
```

Press <Alt+D> to display device properties, or <Alt+M> to display more keys.

More keys for the SAS Topology display:

```
C = Clear Device Mappings for Non-Present Devices
R = Refresh SAS Topology
Enter = On a SAS Enclosure or Expander - Expand or Collapse Item
Enter = On a Disk Drive - Turn on the Locate LED (next key press turns off)
```

2. Information about the volume and its member-disks are then displayed.

```
LSI Logic Config Utility          v6.16.00.00 (2007.05.07)
SAS Topology -- SAS1068

SAS1068105:03:001
├─ Enclosure
│   └─ Direct Attach Devices
│       └─ RAID Physical Disk
│           └─ SEAGATE ST373454SS      0003
│               └─ RAID Physical Disk
│                   └─ RAID Physical Disk
│                       └─ RAID Physical Disk
├─ IS VOL
│   └─ LSILOGICLogical Volume 3000
└─ Controller
    └─ SAS
        └─ SAS
            └─ SAS
```

```
Esc=Exit  F1=Help
Alt+D=Device Properties  Alt+N=More Keys
```

Selecting a boot disk

You can select a boot disk in the **SAS Topology** screen. This disk is then moved to scan ID 0 on the next boot, and remains at this position. This makes it easier to set BIOS boot device options and to keep the boot device constant during device additions and removals. There can be only one boot disk.

Follow these steps to select a boot disk:

1. In the **SAS BIOS CU**, select an adapter from the **Adapter List**.
2. Select the **SAS Topology** option.
The current topology is displayed. If the selection of a boot device is supported, the bottom of the screen lists the **Alt+B** option. This is the key for toggling the boot device. If a device is currently configured as the boot device, the **Device Info** column on the **SAS Topology** screen will show the word **Boot**.
3. To select a boot disk, move the cursor to the disk and press **Alt+B**.
4. To remove the boot designator, move the cursor to the disk and press **Alt+B**. This controller will no longer have a disk designated as boot.
5. To change the boot disk, move the cursor to the new boot disk and press **Alt+B**. The boot designator will move to this disk.



The firmware must be configured correctly in order for the **Alt+B** feature to work.

```
LSI Logic Config Utility          v6.16.00.00 (2007.05.07)
Adapter List  Global Properties

Adapter      PCI   PCI   PCI   PCI   FW Revision      Status  Boot
              BUS  Dev  Fnc  Slot  1.15.00.00-IR    Disabled 0
SAS1068      05   03   00   00

Esc = Exit Menu   F1/Shift+1 = Help
Alt+N = Global Properties  -/+ = Alter Boot Order  Ins/Del = Alter Boot List
```

5.6.6 Global Properties

From the **Setup Utility** screen, press <Alt+N> to enter **LSI Logic Configuration**, then select **Global Properties**. The **Global Properties** menu allows you to change related settings.

```
LSI Logic Config Utility          v6.16.00.00 (2007.05.07)
Adapter List  Global Properties
Adapter      PCI   PCI   PCI   PCI   FW Revision   Status   Boot
              BUS  Dev  Fnc  Slot
SAS1068     05   03   00   00   1.15.00.00-IR Disabled   0

Esc = Exit Menu    F1/Shift+1 = Help
Alt+N = Global Properties  -/+ = Alter Boot Order  Ins/Del = Alter Boot List
```

Pause When Boot Alert Displayed

Sets whether to pause or not when the boot alert displays.

Configuration options: [Yes] [No]

```
LSI Logic Config Utility          v6.16.00.00 (2007.05.07)
Adapter List  Global Properties

Pause When Boot Alert Displayed [No]
Boot Information Display Mode  [Display adapters & installed devices]
Support Interrupt               [Hook interrupt, the Default]

Restore Defaults

Esc = Exit Menu    F1/Shift+1 = Help
Alt+N = Adapter List  -/+ = Change Item
```



Boot Information Display Mode

Sets the disk information display mode.

Configuration options: [Display adapters & installed devices]

[Display minimal information] [Display adapters and all devices]

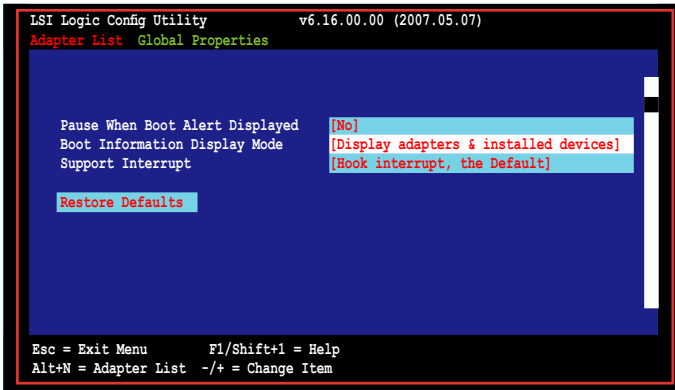
[Display adapters only]



Support Interrupt

Configuration options: [Hook interrupt, the Default] [Bypass interrupt hook]

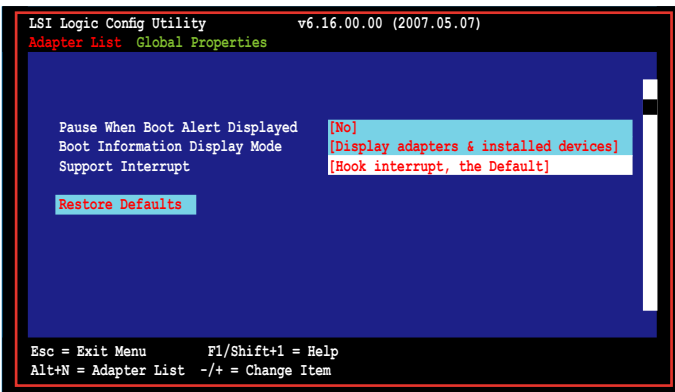

Restore Defaults

This option allows you to discard the selections you made and restore the system defaults.

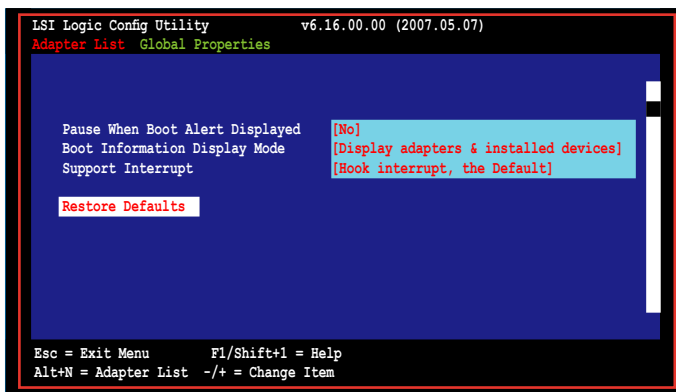

This chapter provides instructions for installing the necessary drivers for different system components.

6 Driver installation

6.1	RAID driver installation	6-1
6.2	Intel chipset software installation	6-13
6.3	LAN driver installation.....	6-16
6.4	VGA driver installation.....	6-22
6.5	Management application and utilities installation	6-24

6.1 RAID driver installation

After creating the RAID sets for your server system, you are now ready to install an operating system to the independent hard disk drive or bootable array. This part provides instructions on how to install the RAID controller drivers during OS installation.

6.1.1 Creating a RAID driver disk



You may have to use another system to create the RAID driver disk from the system/motherboard support CD or from the Internet.

A floppy disk with the RAID driver is required when installing Windows® 2000/2003 or Red Hat® Enterprise operating system on a hard disk drive that is included in a RAID set. You can create a RAID driver disk in DOS (using the Makedisk application in the support CD).

To create a RAID driver disk in DOS environment:

1. Place the motherboard support CD in the optical drive.
2. Restart the computer, then enter the BIOS Setup.
3. Select the optical drive as the first boot priority to boot from the support CD. Save your changes, then exit the BIOS Setup.
4. Restart the computer.
5. Press any key when prompted to boot from CD.

```
Loading FreeDOS FAT KERNEL GO!  
Press any key to boot from CDROM...
```

The Makedisk menu appears.

```
Create Driver Diskette Menu  
INTEL 6321 MATRIX STORAGE MANAGER Driver  
INTEL 6321 LSI MegaRAID Driver  
LSI 1068 B1 SAS Driver  
Marvell 88SE6145 SATA RAID Driver  
Marvell 88SE6145 SATA Non-RAID Driver  
ESB2 ASF Firmware update  
FreeDOS command prompt
```

6. Use the arrow keys to select the type of RAID driver disk you want to create and press <Enter> to enter the sub-menu.

INTEL 6321 MATRIX STORAGE MANAGER Driver

```
INTEL 6321 MATRIX STORAGE MANAGER Driver
Windows 32 bit(Also support AHCI)
Windows 64 bit(Also support AHCI)
Back
Exit
```

INTEL 6321 LSI MegaRAID Driver

```
INTEL 6321 LSI MegaRAID Driver
Windows 2000 Server
Windows Server 2003 32 bit
Windows Server 2003 64 bit
RHEL3 UP8 32/64 bit
RHEL4 UP5 32/64 bit
RHEL 5 32/64 bit
SLES 9.0 SP3 32 bit
SLES 9.0 SP3 64 bit
SLES 10 SP1 32 bit
SLES 10 SP1 64 bit
Back
Exit
```

LSI 1068 B1 SAS Driver

```
LSI 1068 B1 SAS Driver
Windows 2000 Server
Windows Server 2003 32 bit
Windows Server 2003 64 bit
RHEL AS3 UP8 32 bit
RHEL AS3 UP8 64 bit
RHEL AS4 UP5 32 bit
RHEL AS4 UP5 64 bit
RHEL 5 32 bit
RHEL 5 64 bit
SLES 9.0 SP3 32 bit
SLES 9.0 SP3 64 bit
SLES 10 SP1 32 bit
SLES 10 SP1 64 bit
Back
Exit
```

Marvell 88SE6145 SATA RAID Driver

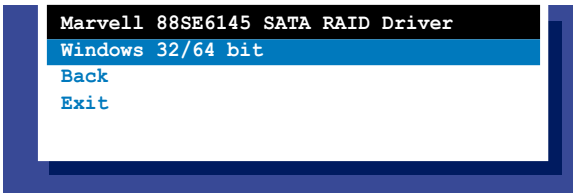

7. Locate the RAID driver and place a blank, high-density floppy disk to the floppy disk drive.
8. Press <Enter>.
9. Follow screen instructions to create the driver disk.

To create a RAID driver disk in Windows® 2000/2003 Server environment:

1. Restart the system from the hard disk drive, then place the system/motherboard support CD in the optical drive.
2. Browse the contents of the support CD to locate the driver disk utility. The Windows 32-bit OS RAID driver disk for the Intel® Matrix Storage Manager is located in:

\\Drivers\6321 Matrix Storage Manager\F6 Install Floppy Create for 32 and 64 bit Windows\F6flpy32.exe

The Windows 2003 64-bit OS RAID driver disk for the Intel® Matrix Storage Manager is located in:

\\Drivers\6321 Matrix Storage Manager\F6 Install Floppy Create for 32 and 64 bit Windows\F6flpy64.exe

The Windows 2000 32-bit RAID driver disk for the LSI Logic Embedded SATA RAID is located in:

\\Drivers\6321 LSI MegaRAID\Driver\makedisk\win2k.exe or win2k.zip

The Windows Server 2003 32-bit RAID driver disk for the LSI Logic Embedded SATA RAID is located in:

\\Drivers\6321 LSI MegaRAID\Driver\makedisk\win2k3_x86.exe or win2k3_x86.zip

The Windows Server 2003 64-bit RAID driver disk for the LSI Logic Embedded SATA RAID is located in:

\\Drivers\6321 LSI MegaRAID\Driver\makedisk\win2k3_x64.exe or win2k3_x64.zip

The Windows 2000 32-bit RAID driver disk for the LSI1068 SAS is located in:

\\Drivers\LSI 1068 B1\Driver\makedisk\2k.exe

The Windows Server 2003 32-bit RAID driver disk for the LSI1068 SAS is located in:

\\Drivers\LSI 1068 B1\Driver\makedisk\2k3_32.exe

The Windows Server 2003 64-bit OS RAID driver disk for the LSI1068 SAS controller is located in:

\Drivers\LSI 1068 B1\Driver\makedisk\2k3_64.exe

The Windows Server 2003 32-bit/64-bit OS and Windows 2000 SP4 RAID driver disk for Marvell SATA controller is located in:

\Drivers\MARVELL 6145 SATA RAID\Driver\makedisk\mv6145.exe
or **mv6145.zip**

3. Insert a formatted high-density floppy disk to the floppy disk drive.
4. Follow screen instructions to complete the process.
5. After creating a RAID driver disk, eject the floppy disk, then write-protect it to prevent computer virus infection.

To create a RAID driver disk in Red Hat® Enterprise Linux server environment:

1. Insert a blank formatted high-density floppy disk to the floppy disk drive.
2. Decompress the file into the floppy disk from the following path in the support CD:

For LSI Logic Embedded SATA RAID Driver:

\Drivers\6321 LSI MegaRAID\Driver\makedisk

For LSI1068 SAS RAID Driver:

\Drivers\LSI 1068 B1\Driver\Makedisk

For Marvell SATA RAID Driver:

\Drivers\MARVELL 6145 SATA RAID\Driver\Linux

3. Eject the floppy disk.



For systems with other Linux versions that are not listed in the Makedisk menu, explore the support CD and copy the driver file from the following path: For LSI Logic Embedded SATA RAID Driver:\Drivers\6321 LSI MegaRAID\ Driver\Linux; For LSI1068 SAS RAID Driver:\Drivers\LSI 1068 B1\Drivers\Linux; For Marvell SATA RAID Driver:\Drivers\MARVELL 6145 SATA RAID\Driver\Linux.

6.1.2 Installing the RAID controller driver

Windows® 2000/2003 Server OS



When installing the LSI 1068 driver to your OS, make sure the driver you are installing supports your current installed OS. We STRONGLY RECOMMEND that you use the LSI 1068 SAS utility bundled in the support CD to create a driver disk. Refer to page 6-1 for more information.

During Windows® 2000/2003 Server OS installation

To install the RAID controller driver when installing Windows® 2000/2003 Server OS:

1. Boot the computer using the Windows® 2000/2003 Server installation CD. The Windows® 2000/2003 Setup starts.

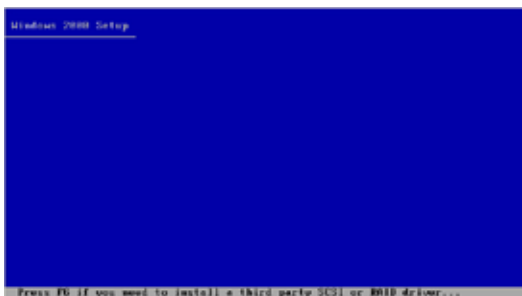

2. Press <F6> when the message “Press F6 if you need to install a third party SCSI or RAID driver...” appears at the bottom of the screen.
3. When prompted, press <S> to specify an additional device.

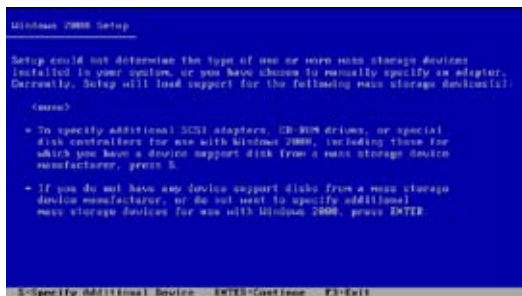

4. Insert the RAID driver disk you created earlier to the floppy disk drive, then press <Enter>.

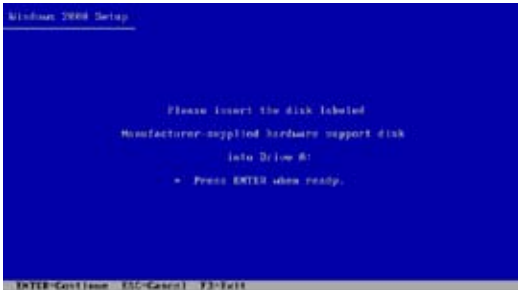

5. Select the RAID controller driver from the list, then press <Enter>.

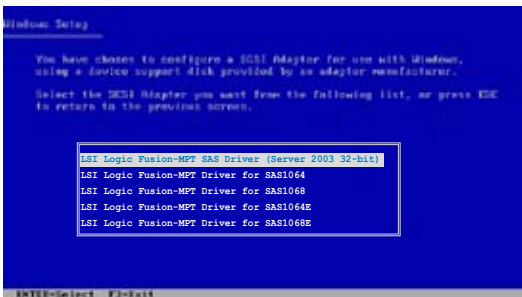

- **Intel® 6321ESB Intel® MATRIX STORAGE driver:**
 - If SATA RAID mode is to be enabled, select **Intel ESB2 SATA RAID Controller (Server ESB2)**.
 - If SATA AHCI mode is enabled, select **Intel ESB2 SATA AHCI Controller (Server ESB2)**.

- **Intel® 6321ESB LSI Logic Embedded SATA RAID driver** (DSEB-DG model only):
 - For Windows 2000 OS, select **LSI MegaRAID Software RAID (Windows 2000 SP4)**.
 - For Windows 2003 OS, select **LSI MegaRAID Software RAID (Windows 2003)**.
 - **LSI1068 PCI-X SAS controller driver** (DSEB-DG/ SAS model only):
 - For Windows 2000, select **LSI Logic Fusion-MPT Drivers for SAS1068**.
 - For 32bit Windows Server 2003, select **LSI Logic Fusion-MPT SAS Driver (Server 2003 32-bit)**.
 - **Marvell SATA controller driver** (DSEB-DG model only):
 - For 32bit Windows Server 2003 and Windows 2000 SP4, select **Marvell 61XX SATA Controller 32bit Driver**.
 - For 64 bit Windows Server 2003, select **Marvell 61XX SATA Controller 64bit Driver**.
6. The Windows® 2000/2003 Setup loads the RAID controller drivers from the RAID driver disk. When prompted, press <Enter> to continue installation.
 7. Setup then proceeds with the OS installation. Follow screen instructions to continue.

To an existing Windows® 2000/2003 Server OS

To install the RAID controller driver on an existing Windows® 2000/2003 Server OS:

1. Restart the computer, then log in with **Administrator** privileges.
2. Windows® automatically detects the RAID controller and displays a **New Hardware Found** window. Click **Cancel**.
3. Right-click the **My Computer** icon on the Windows® desktop, then select **Properties** from the menu.
4. Click the **Hardware** tab, then click the **Device Manager** button to display the list of devices installed in the system.

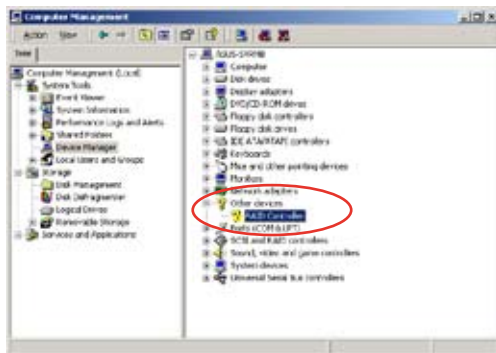

5. Right-click the **RAID controller** item, then select **Properties**.
6. Click the **Driver** tab, then click the **Update Driver** button.
7. The **Upgrade Device Driver Wizard** window appears. Click **Next**.
8. Insert the RAID driver disk you created earlier to the floppy disk drive.
9. Select the option **Search for a suitable driver for my device (recommended)**, then click **Next**.
10. The wizard searches the RAID controller drivers. When found, click **Next** to install the drivers.
11. Click **Finish** after the driver installation is done.



To verify the RAID controller driver installation:

1. Right-click the **My Computer** icon on the Windows® desktop , then select **Properties** from the menu.
2. Click the **Hardware** tab, then click the **Device Manager** button.
3. Click the “+” sign before the item **SCSI and RAID controllers**, then the LSI Adapter, SAS 3000 series, 8-port with 1068-StorPort item should appear.

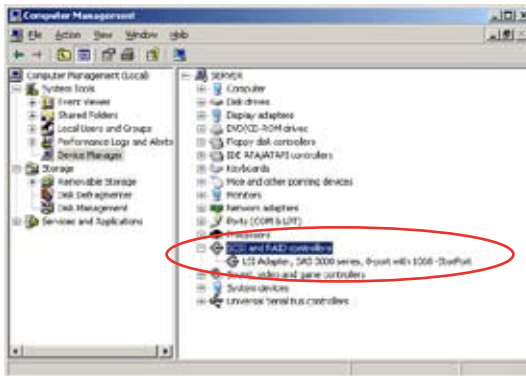

The screen differs based on the controller.

4. Right-click the **RAID controller** driver item, then select **Properties** from the menu.
5. Click the **Driver** tab, then click the **Driver Details** button to display the RAID controller drivers.
6. Click **OK** when finished.

Red Hat® Enterprise

To install the Intel® 6321ESB LSI Logic Embedded SATA RAID controller driver when installing Red Hat® Enterprise OS:

1. Boot the system from the Red Hat® Installation CD.

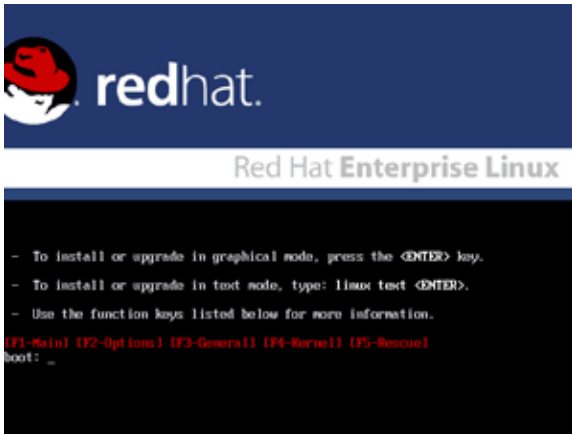

2. At the `boot:`, type `linux dd`, then press <Enter>.



When installing a Red Hat 2.4 kernel with a Driver Update Disk (DUD) to a disk drive attached to a LSI HBA, use the command below at the install prompt:
linux dd updates.

3. Select **Yes** using the <Tab> key when asked if you have the driver disk. Press <Enter>

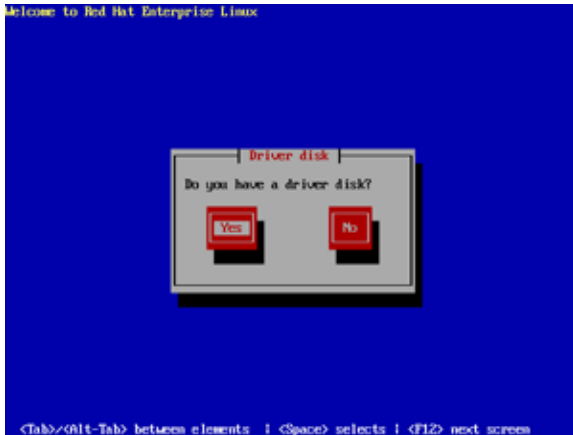

4. Select **fd0** using the <Tab> key when asked to select the driver disk source. Press <Tab> to move the cursor to **OK**, then press <Enter>.

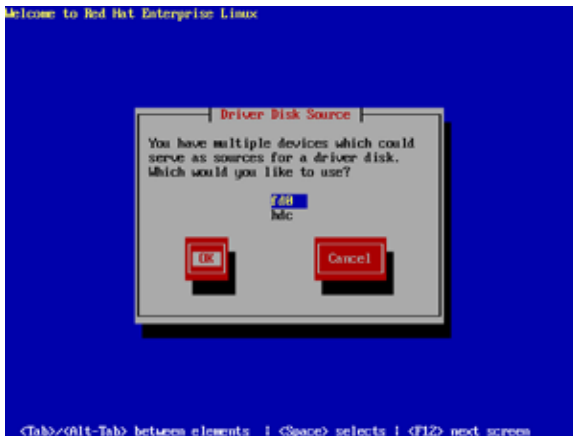

- When prompted, insert the Red Hat® Enterprise RAID driver disk to the floppy disk drive, select **OK**, then press <Enter>.

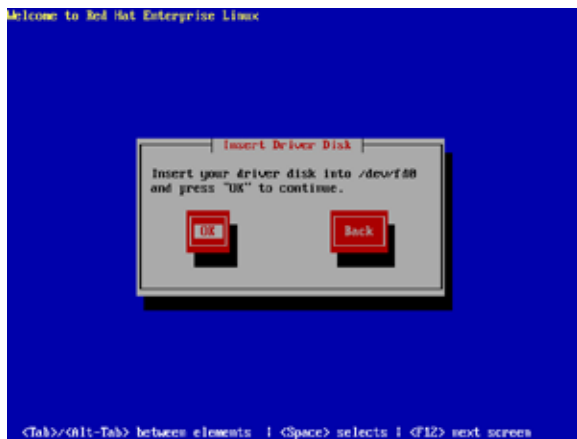

The drivers for the RAID controller are installed to the system.

- Follow screen instructions to continue the OS installation.

6.2 Intel chipset software installation

This section provides instructions on how to install the Plug and Play components for the Intel® chipset on the system.

You need to manually install the Intel® chipset software on a Windows 2000 / Server 2003 operating system. To install the Intel® chipset software:

1. Restart the computer, then log on with **Administrator** privileges.
2. Insert the motherboard/system support CD to the optical drive. The support CD automatically displays the **Drivers** menu if Autorun is enabled in your computer.
3. Click the item **Intel(R) Chipset Software Installation Utility** from the menu.



4. The **Intel(R) Chipset Software Installation Utility** window appears. Follow the screen instructions to complete installation.

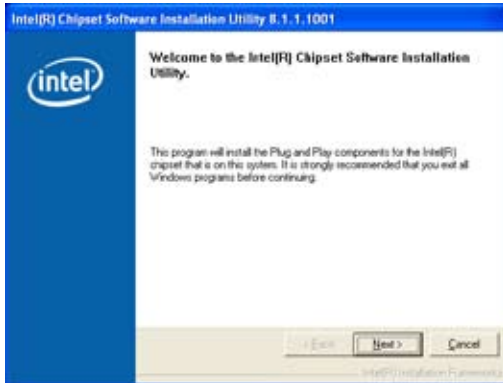

5. Select **Yes** to accept the terms of the **License Agreement** and continue the process.



6. Read the **Readme File Information** and press **Next** to activate the installation.

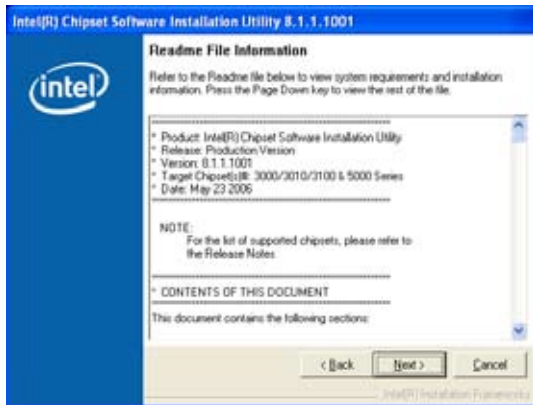

7. After completing the installation, click **Finish** to restart the computer.



6.3 LAN driver installation

This section provides the instructions on how to install Intel® Gigabit LAN controller drivers.

6.3.1 Windows 2000/Server 2003

To install the Intel® Gigabit LAN controller driver on a Windows® 2000/ Server 2003 OS:

1. Restart the computer, and then log on with **Administrator** privileges.
2. Insert the motherboard/system support CD to the optical drive. The CD automatically displays the **Drivers** menu if Autorun is enabled in your computer.
 - Windows® automatically detects the LAN controllers and displays window. Click **Cancel** to close this window.
 - If **Autorun** is NOT enabled in your computer, browse the contents of the support CD to locate the file **AUTORUN.EXE** from the **\Drivers\Intel 82563EB** folder. Double-click the **AUTORUN.EXE** and follow step 4 to run the installation.
3. Click the **Intel® PRO/1000 EB Network Connection** option.



4. Click the **Install Drivers** option to begin installation.



5. Click **Next** button when the **Intel® PRO Network Connections – InstallShield Wizard** window appears.



6. Select **I accept the terms in the license agreement** and then click the **Next** button.



7. Press the **Complete** and click **Next** button to fully install the driver, Intel® PROSet for Windows Device Manager and Advanced Networking Services.



8. Follow the screen instructions to complete installation.

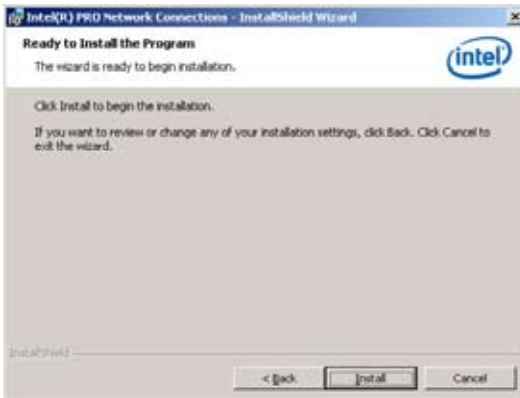

9. When finished, press **Finish** to continue.

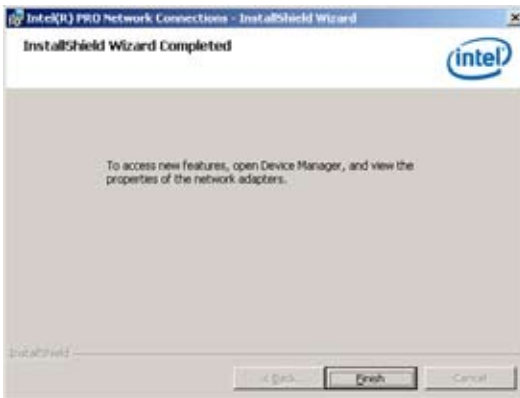

To verify the LAN controller driver installation:

1. Right-click the My Computer icon on the Windows® desktop , then select Properties from the menu.
2. Click the Hardware tab, then click the Device Manager button.
3. Click the “+” sign before the item Network adapters, then Intel(R) PRO/1000 EB Network Connection with I/O Acceleration item should appear.

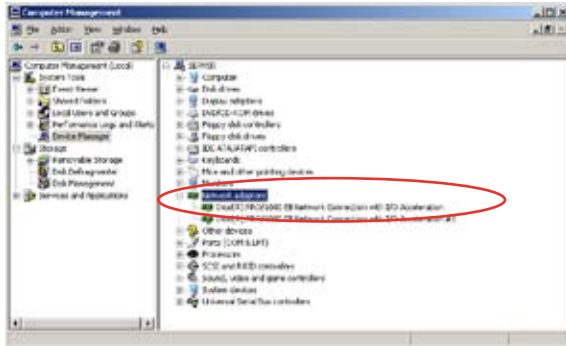

6.3.2 Red Hat

Follow these instructions when installing the Intel® LAN controller base driver for the in Red Hat® operating system.

Before installing the LAN driver:

Before installing the LAN driver, you must install the kernel development application. To install the kernel development:

1. Insert the Linux OS installation CD Disk 1 to the optical drive.
2. Double click **Application > System setting > Add / Remove application**.
3. Select **Kernel Development** from the **Development Tools**.
4. Follow the later steps and add different CDs according to the instructions displayed.

Building the driver from the TAR file:

1. Insert the motherboard/system support CD to the optical drive and mount the optional drive in the Linux platform.
2. Copy the base driver tar file from the motherboard/system support CD to the directory of your local hard disk. The name format of driver file is **e1000-<Version>.tar.gz**.

For example: the file name of driver version 7.0.38 is **e1000-7.0.38.tar.gz**.

- The Intel® LAN driver for Linux OS is located in:

\\Drivers\INTEL 82563EB\PRO1000\LINUX

3. Untar or unzip the archive.
tar xzf e1000-x.x.x.tar.gz
4. Change to the driver src directory.
cd e1000-x.x.x/src/
5. Use the command “makeinstall” to compile the driver module.
makeinstall
6. After reboot the system, please refer to Linux distribution documentation to configure the network protocol and IP address.

6.4 VGA driver installation

This section provides instructions on how to install the XGI Volari Z9s Video Graphics Adapter (VGA) driver.

6.4.1 Windows® 2000/Server 2003

You need to manually install the XGI Volari Z9s VGA driver on a Windows® 2000 / Server 2003 operating system. To install the XGI Volari Z9s VGA driver:

1. Restart the computer, then log on with Administrator privileges.
2. Insert the motherboard/system support CD to the optical drive. The support CD automatically displays the Drivers menu if Autorun is enabled in your computer.

The **Drivers** menu if Autorun is enabled in your computer.



3. The **XGI VGA Package** window appears, preparing the setup.

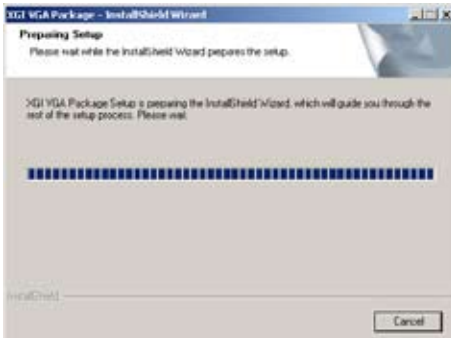

4. Click **Next** to start the installation.



5. The system will update the VGA driver.
6. When the installation completes, click **Finish** to restart your computer before using the program.



6.5 Management applications and utilities installation

The support CD that came with the motherboard package contains the drivers, management applications, and utilities that you can install to avail all motherboard features.



The contents of the support CD are subject to change at any time without notice. Visit the ASUS website (www.asus.com) for updates.

6.5.1 Running the support CD

Place the support CD to the optical drive. The CD automatically displays the Drivers menu if Autorun is enabled in your computer.



If Autorun is NOT enabled in your computer, browse the contents of the support CD to locate the file ASSETUP.EXE from the BIN folder. Double-click the ASSETUP.EXE to run the CD.

6.5.2 Drivers menu

The Drivers menu shows the available device drivers if the system detects installed devices. Install the necessary drivers to activate the devices.



The screen display and driver options vary under different operating system versions.



6.5.3 Management Software menu

The Management Software menu displays the available network and server monitoring applications. Click an item to install.



6.5.4 Utilities menu

The Utilities menu displays the software applications and utilities that the motherboard supports. Click an item to install.



6.5.5 Contact information

Click the Contact tab to display the ASUS contact information. You can also find this information on the inside front cover of this user guide.



This appendix includes additional information that you may refer to when configuring the motherboard.

Reference information



Appendix summary



A.1	DSEB-DG/SAS model block diagram	A-1
A.2	DSEB-DG model block diagram.....	A-2

A.1 DSEB-DG/SAS model block diagram

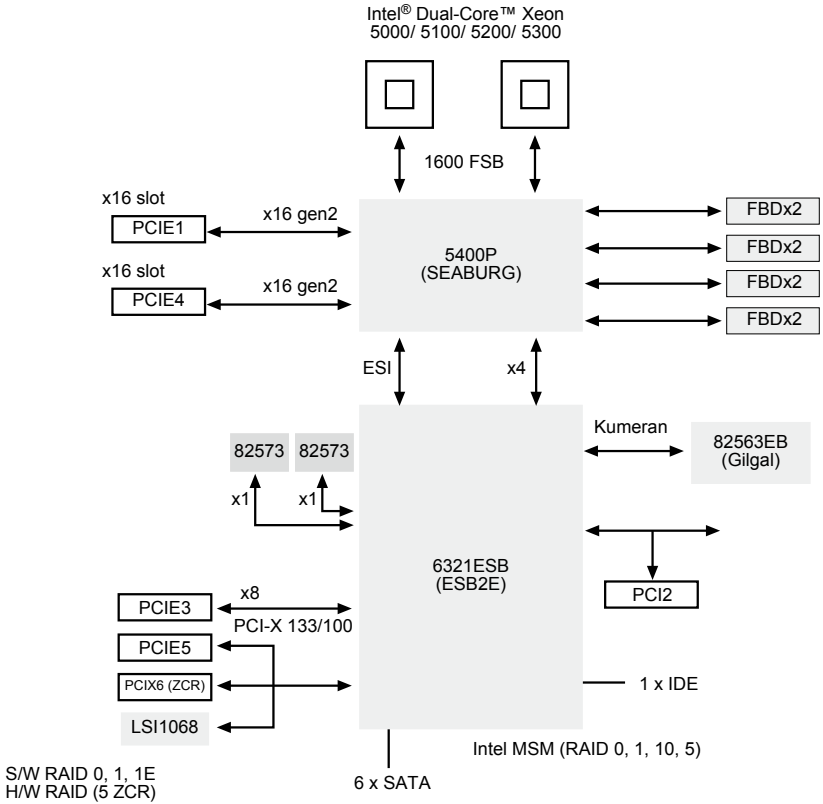

A.2 DSEB-DG model block diagram

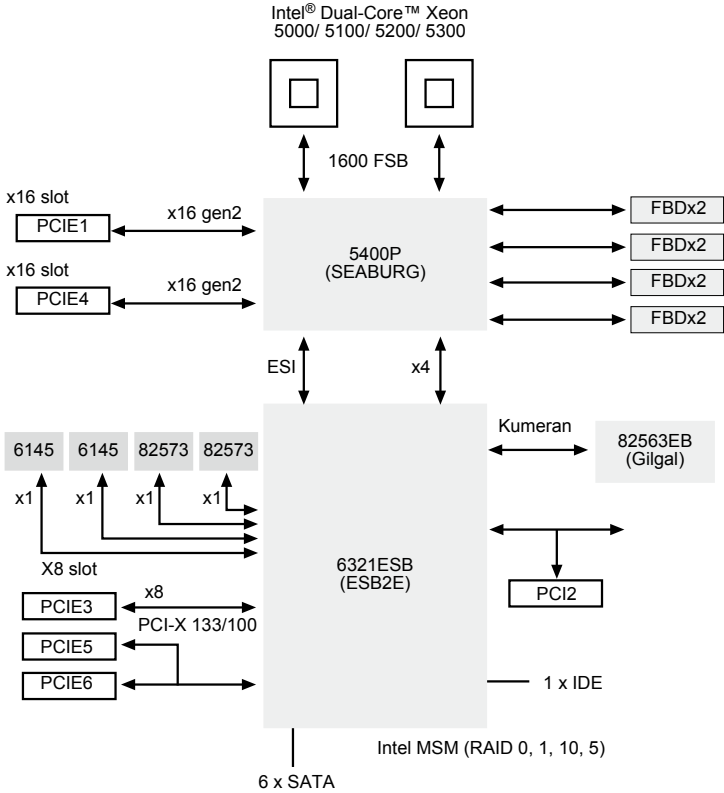

Free Manuals Download Website

<http://myh66.com>

<http://usermanuals.us>

<http://www.somanuals.com>

<http://www.4manuals.cc>

<http://www.manual-lib.com>

<http://www.404manual.com>

<http://www.luxmanual.com>

<http://aubethermostatmanual.com>

Golf course search by state

<http://golfingnear.com>

Email search by domain

<http://emailbydomain.com>

Auto manuals search

<http://auto.somanuals.com>

TV manuals search

<http://tv.somanuals.com>