

ASUS[®]

V-Series V2-PE2

ASUS PC (Desktop Barebone)



E2506

**First Edition V1
March 2006**

Copyright © 2006 ASUSTeK COMPUTER INC. All Rights Reserved.

No part of this manual, including the products and software described in it, may be reproduced, transmitted, transcribed, stored in a retrieval system, or translated into any language in any form or by any means, except documentation kept by the purchaser for backup purposes, without the express written permission of ASUSTeK COMPUTER INC. ("ASUS").

Product warranty or service will not be extended if: (1) the product is repaired, modified or altered, unless such repair, modification or alteration is authorized in writing by ASUS; or (2) the serial number of the product is defaced or missing.

ASUS PROVIDES THIS MANUAL "AS IS" WITHOUT WARRANTY OF ANY KIND, EITHER EXPRESS OR IMPLIED, INCLUDING BUT NOT LIMITED TO THE IMPLIED WARRANTIES OR CONDITIONS OF MERCHANTABILITY OR FITNESS FOR A PARTICULAR PURPOSE. IN NO EVENT SHALL ASUS, ITS DIRECTORS, OFFICERS, EMPLOYEES OR AGENTS BE LIABLE FOR ANY INDIRECT, SPECIAL, INCIDENTAL, OR CONSEQUENTIAL DAMAGES (INCLUDING DAMAGES FOR LOSS OF PROFITS, LOSS OF BUSINESS, LOSS OF USE OR DATA, INTERRUPTION OF BUSINESS AND THE LIKE), EVEN IF ASUS HAS BEEN ADVISED OF THE POSSIBILITY OF SUCH DAMAGES ARISING FROM ANY DEFECT OR ERROR IN THIS MANUAL OR PRODUCT.

SPECIFICATIONS AND INFORMATION CONTAINED IN THIS MANUAL ARE FURNISHED FOR INFORMATIONAL USE ONLY, AND ARE SUBJECT TO CHANGE AT ANY TIME WITHOUT NOTICE, AND SHOULD NOT BE CONSTRUED AS A COMMITMENT BY ASUS. ASUS ASSUMES NO RESPONSIBILITY OR LIABILITY FOR ANY ERRORS OR INACCURACIES THAT MAY APPEAR IN THIS MANUAL, INCLUDING THE PRODUCTS AND SOFTWARE DESCRIBED IN IT.

Products and corporate names appearing in this manual may or may not be registered trademarks or copyrights of their respective companies, and are used only for identification or explanation and to the owners' benefit, without intent to infringe.

Table of contents

Notices	vi
Safety information	vii
About this guide.....	viii
System package contents.....	x

Chapter 1: System Introduction

1.1	Welcome!	1-2
1.2	Front panel (external).....	1-2
1.3	Rear panel.....	1-4
1.4	Internal components.....	1-7
1.6	LED panel.....	1-10

Chapter 2: Basic Installation

2.1	Preparation	2-2
2.2	Before you proceed	2-2
2.3	Removing the side cover and front panel assembly	2-3
2.4	Central Processing Unit (CPU)	2-4
2.4.1	Overview	2-4
2.4.2	Installing the CPU.....	2-4
2.4.3	Installing the CPU fan and heatsink assembly	2-6
2.5	Installing a DIMM	2-8
2.5.1	Memory configurations	2-8
2.5.2	Installing a DDR2 DIMM	2-11
2.5.3	Removing a DDR2 DIMM.....	2-11
2.6	Expansion slots	2-12
2.6.1	Installing an expansion card	2-12
2.6.2	Configuring an expansion card	2-12
2.6.3	PCI Express x1 slot	2-14
2.6.4	PCI slots.....	2-14
2.6.5	PCI Express x16 slot	2-14
2.7	Installing an optical drive	2-15
2.8	Installing a hard disk drive	2-17
2.9	Installing a floppy disk drive.....	2-20
2.10	Re-connecting cables.....	2-21
2.11	Reinstalling the cover	2-22

Table of contents

Chapter 3: Starting up

3.1	Installing an operating system.....	3-2
3.2	Powering up	3-2
3.3	Support CD information	3-2
3.3.1	Running the support CD.....	3-3
3.3.2	Utilities menu	3-4
3.3.3	Make disk	3-5
3.3.4	ASUS contact information	3-5
3.4	Software information.....	3-6

Chapter 4: Motherboard Info

4.1	Introduction	4-2
4.2	Motherboard layout	4-2
4.3	Jumpers	4-3
4.4	Connectors	4-6

Chapter 5: BIOS Information

5.1	Managing and updating your BIOS	5-2
5.1.1	ASUS Update utility	5-2
5.1.2	Creating a bootable floppy disk	5-5
5.1.3	ASUS EZ Flash utility	5-6
5.1.4	AwardBIOS Flash utility	5-7
5.1.5	Saving the current BIOS file	5-9
5.1.5	ASUS CrashFree BIOS 2 utility	5-10
5.2	BIOS setup program.....	5-11
5.2.1	BIOS menu screen.....	5-12
5.2.2	Menu bar	5-12
5.2.3	Legend bar.....	5-13

Table of contents

5.2.4	Menu items	5-13
5.2.5	Sub-menu items	5-13
5.2.6	Configuration fields	5-13
5.2.7	Pop-up window	5-14
5.2.8	General help	5-14
5.3	Main menu	5-15
5.3.1	System Time	5-15
5.3.2	System Date	5-15
5.3.3	Legacy Diskette A	5-14
5.3.4	Primary, Third, and Fourth IDE Master/Slave	5-16
5.3.5	Primary IDE Master/Slave	5-16
5.3.6	First/Second SATA Master	5-18
5.3.7	HDD SMART Monitoring	5-19
5.3.8	Installed Memory	5-19
5.3.9	Usable Memory	5-19
5.4	Advanced menu	5-19
5.4.1	CPU Configuration	5-20
5.4.2	Chipset	5-21
5.4.3	PCIPnP	5-23
5.4.4	Onboard Device Configuration	5-24
5.4.5	USB Configuration	5-25
5.5	Power menu	5-26
5.5.1	ACPI Suspend Type	5-26
5.5.2	ACPI APIC Support	5-26
5.5.3	APM Configuration	5-27
5.5.4	Hardware Monitor	5-29
5.6	Boot menu	5-30
5.6.1	Boot Device Priority	5-30
5.6.2	Boot Settings Configuration	5-31
5.6.3	Security	5-32
5.7	Exit menu	5-33

Notices

Federal Communications Commission Statement

This device complies with Part 15 of the FCC Rules. Operation is subject to the following two conditions:

- This device may not cause harmful interference, and
- This device must accept any interference received including interference that may cause undesired operation.

This equipment has been tested and found to comply with the limits for a Class B digital device, pursuant to Part 15 of the FCC Rules. These limits are designed to provide reasonable protection against harmful interference in a residential installation. This equipment generates, uses and can radiate radio frequency energy and, if not installed and used in accordance with manufacturer's instructions, may cause harmful interference to radio communications. However, there is no guarantee that interference will not occur in a particular installation. If this equipment does cause harmful interference to radio or television reception, which can be determined by turning the equipment off and on, the user is encouraged to try to correct the interference by one or more of the following measures:

- Reorient or relocate the receiving antenna.
- Increase the separation between the equipment and receiver.
- Connect the equipment to an outlet on a circuit different from that to which the receiver is connected.
- Consult the dealer or an experienced radio/TV technician for help.



WARNING! The use of shielded cables for connection of the monitor to the graphics card is required to assure compliance with FCC regulations. Changes or modifications to this unit not expressly approved by the party responsible for compliance could void the user's authority to operate this equipment.

Canadian Department of Communications Statement

This digital apparatus does not exceed the Class B limits for radio noise emissions from digital apparatus set out in the Radio Interference Regulations of the Canadian Department of Communications.

This class B digital apparatus complies with Canadian ICES-003.

Safety information

Electrical safety

- To prevent electrical shock hazard, disconnect the power cable from the electrical outlet before relocating the system.
- When adding or removing devices to or from the system, ensure that the power cables for the devices are unplugged before the signal cables are connected.
- If the power supply is broken, do not try to fix it by yourself. Contact a qualified service technician or your retailer.

Operation safety

- Before installing devices into the system, carefully read all the documentation that came with the package.
- Before using the product, make sure all cables are correctly connected and the power cables are not damaged. If you detect any damage, contact your dealer immediately.
- To avoid short circuits, keep paper clips, screws, and staples away from connectors, slots, sockets and circuitry.
- Avoid dust, humidity, and temperature extremes. Do not place the product in any area where it may become wet. Place the product on a stable surface.
- If you encounter technical problems with the product, contact a qualified service technician or your retailer.

Lithium-Ion Battery Warning

CAUTION: Danger of explosion if battery is incorrectly replaced. Replace only with the same or equivalent type recommended by the manufacturer. Dispose of used batteries according to the manufacturer's instructions.

VORSICHT: Explosionsgefahr bei unsachgemäßen Austausch der Batterie. Ersatz nur durch denselben oder einem vom Hersteller empfohlenem ähnlichen Typ. Entsorgung gebrauchter Batterien nach Angaben des Herstellers.

LASER PRODUCT WARNING

CLASS 1 LASER PRODUCT

About this guide

Audience

This guide provides general information and installation instructions about the ASUS Vintage V-Series V2-PE2 barebone system. This guide is intended for experienced users and integrators with hardware knowledge of personal computers.

How this guide is organized

This guide contains the following parts:

1. Chapter 1: System introduction

This chapter gives a general description of the ASUS Vintage V2-PE2. The chapter lists the system features, including introduction on the front and rear panel, and internal components.

2. Chapter 2: Basic installation

This chapter provides step-by-step instructions on how to install components in the system.

3. Chapter 3: Starting up

This chapter helps you power up the system and install drivers and utilities from the support CD.

4. Chapter 4: Motherboard information

This chapter gives information about the motherboard that comes with the system. This chapter includes the motherboard layout, jumper settings, and connector locations.

5. Chapter 5: BIOS information

This chapter tells how to change system settings through the BIOS Setup menus and describes the BIOS parameters.

Conventions used in this guide



WARNING: Information to prevent injury to yourself when trying to complete a task.



CAUTION: Information to prevent damage to the components when trying to complete a task.



IMPORTANT: Instructions that you **MUST** follow to complete a task.



NOTE: Tips and additional information to aid in completing a task.

Where to find more information

Refer to the following sources for additional information and for product and software updates.

1. ASUS Websites

The ASUS websites worldwide provide updated information on ASUS hardware and software products. Refer to the ASUS contact information.

2. Optional Documentation

Your product package may include optional documentation, such as warranty flyers, that may have been added by your dealer. These documents are not part of the standard package.

System package contents

Check your Vintage V2-PE2 system package for the following items.



If any of the items is damaged or missing, contact your retailer immediately.

Item description
1. ASUS Vintage V2-PE2 barebone system with
• ASUS motherboard
• 300 W PFC power supply unit
• ASUS chassis
2. Cable
• AC power cable
3. Support CD
4. User guide

Chapter 1

This chapter gives a general description of the ASUS Vintage V2-PE2. The chapter lists the system features including introduction on the front and rear panel, and internal components.

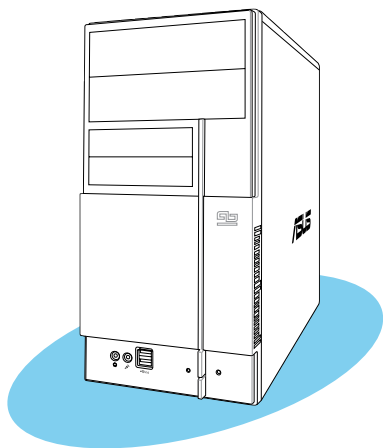

System introduction

1.1 Welcome!

Thank you for choosing the ASUS Vintage V2-PE2!

The ASUS Vintage V2-PE2 is an all-in-one barebone system with a versatile home entertainment feature.

The system comes in a stylish casing and powered by the ASUS motherboard that supports the Intel® Pentium® D, Intel® Pentium® 4 or Intel® Celeron® processor in the 775-land package.

The system supports up to 2 GB of system memory using DDR2-533/400 DIMMs. High-resolution graphics via integrated graphics controller or PCI Express x16 slot, Serial ATA, USB 2.0, and 6-channel audio feature the system and take you ahead in the world of power computing.

1.2 Front panel

The front panel includes the optical drive bays, floppy disk drive slot, power button, and several I/O ports are located at the front panel.

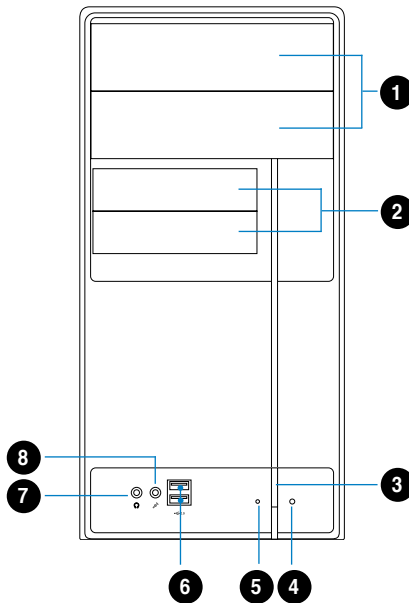

1. **Two empty 5.25-inch bays.** These bays are for IDE optical drives.
2. **3.5-inch drive bays.** These slots are for 3.5-inch floppy or hard disk drives.
3. **Power button.** Press this button to turn the system on.
4. **Reset button.** Press this button to reboot the system without turning off the power.
5. **HDD LED.** This LED lights up when data is read from or written to the hard disk drive.
6. **USB 2.0 ports.** These Universal Serial Bus 2.0 (USB 2.0) ports are available for connecting USB 2.0 devices such as a mouse, printer, scanner, camera, PDA, and others.
7. **Headphone port.** This Line In (green) port connects a headphone with a stereo mini-plug.
8. **Microphone port.** This Mic (pink) port connects a microphone.

1.3 Rear panel

The system rear panel includes the power connector and several I/O ports that allow convenient connection of devices.

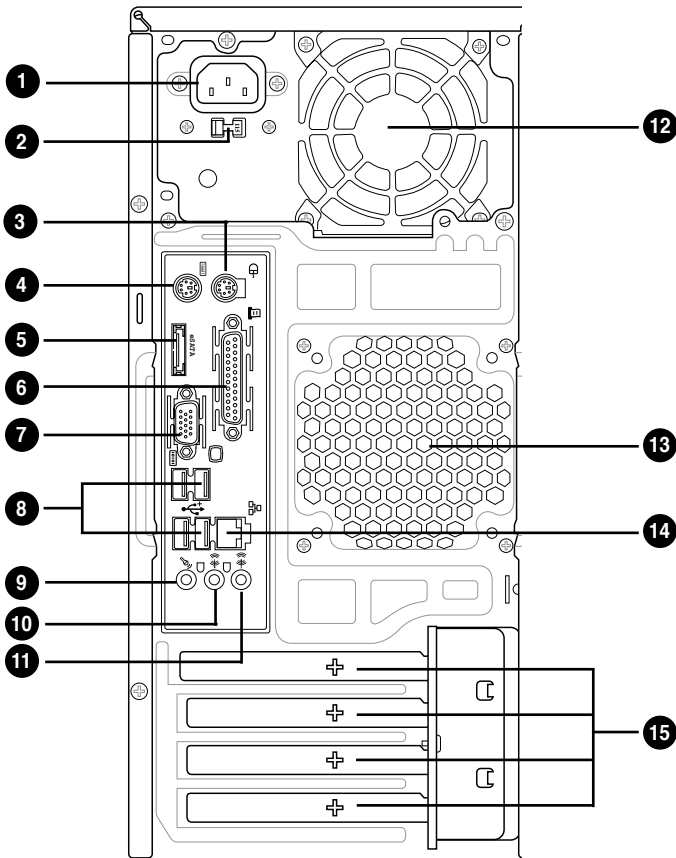

1. **Power connector.** This connector is for the power cable and plug.
2. **Voltage selector.** This switch allows you to adjust the system input voltage according to the voltage supply in your area. See the section “Voltage selector” on page 1-6 before adjusting this switch.
3. **PS/2 mouse port.** This green 6-pin connector is for a PS/2 mouse.
4. **PS/2 keyboard port.** This purple 6-pin connector is for a PS/2 keyboard.
5. **External SATA port.** This port connects to an external SATA box or a Serial ATA port multiplier.

6. **Parallel port.** This 25-pin port connects a printer, scanner, or other devices.
7. **VGA port.** This port connects a VGA monitor.
8. **USB 2.0 ports 1, 2, 3 and 4.** These 4-pin Universal Serial Bus (USB) ports are available for connecting USB 2.0 devices.
9. **Microphone port (pink).** This port connects a microphone.
10. **Line Out port (lime).** This port connects a headphone or a speaker. In 4-channel and 6-channel configuration, the function of this port becomes Front Speaker Out.
11. **Line In port (light blue).** This port connects the tape, CD, DVD player, or other audio sources.
12. **Power supply unit fan vent.** This vent is for the PSU fan that provides ventilation inside the power supply unit.
13. **Chassis fan vent.** This vent is for the fan that provides ventilation inside the system chassis.
14. **LAN (RJ-45) port.** This port allows Gigabit connection to a Local Area Network (LAN) through a network hub.
15. **Expansion slot covers.** Remove these covers when installing expansion cards.



Refer to the audio configuration table below for the function of the audio ports in 2, 4, or 6-channel configuration.

Audio 2, 4, or 6-channel configuration

Port	Headset 2-speaker	4-speaker	6-speaker
Light Blue	Line In	Surround Out	Surround Out
Lime	Line Out	Front Speaker Out	Front Speaker Out
Pink	Mic In	Mic In	Center/Bass

Voltage selector

The PSU has a 115 V/230 V voltage selector switch located beside the power connector. Use this switch to select the appropriate system input voltage according to the voltage supply in your area.

If the voltage supply in your area is 100-127 V, set this switch to 115 V.

If the voltage supply in your area is 200-240 V, set this switch to 230 V.

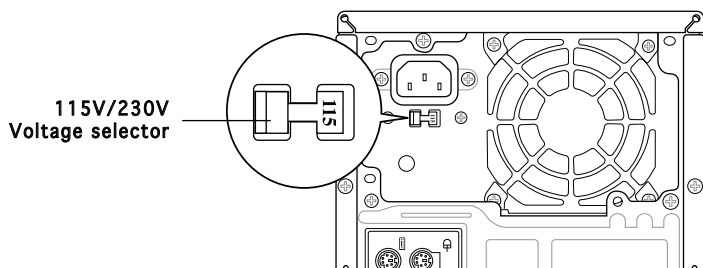

Setting the switch to 115V in a 230V environment or 230V in a 115V environment will seriously damage the system!

1.4 Internal components

The illustration below is the internal view of the system when you remove the top cover and the power supply unit. The installed components are labeled for your reference. Proceed to Chapter 2 for instructions on installing additional system components.

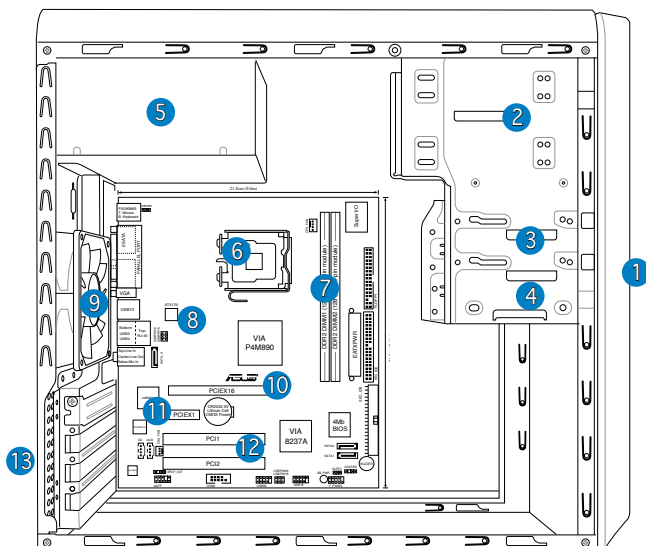

- | | |
|---------------------------------|--------------------------|
| 1. Front panel cover | 8. ASUS motherboard |
| 2. 5.25-inch optical drive bays | 9. Chassis fan |
| 3. Hard disk drive bay | 10. PCI Express x16 slot |
| 4. Floppy disk drive bay | 11. PCI Express x1 slot |
| 5. Power supply unit | 12. PCI slots |
| 6. CPU socket | 13. Metal bracket lock |
| 7. DIMM sockets | |

Chapter 2

This chapter provides step-by-step instructions on how to install components in the system.

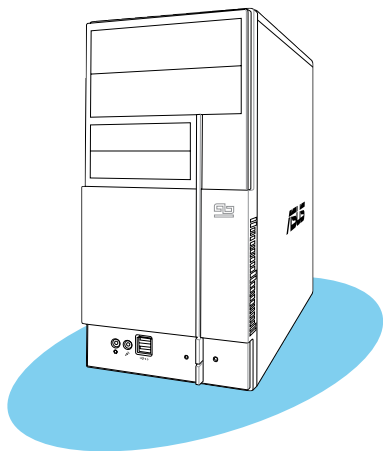

Basic installation

2.1 Preparation

Before you proceed, make sure that you have all the components you plan to install in the system.

Basic components to install

1. Central Processing Unit (CPU)
2. DDR2 Dual Inline Memory Module (DIMM)
3. Expansion card(s)
4. Hard disk drive
5. Optical drive
6. Floppy disk drive

Tool

Phillips (cross) screw driver

2.2 Before you proceed

Take note of the following precautions before you install components into the system.



- Use a grounded wrist strap or touch a safely grounded object or a metal object, such as the power supply case, before handling components to avoid damaging them due to static electricity.
- Hold components by the edges to avoid touching the ICs on them.
- Whenever you uninstall any component, place it on a grounded antistatic pad or in the bag that came with the component.

The motherboard comes with an onboard standby power LED. This LED lights up to indicate that the system is ON, in sleep mode or in soft-off mode, and not powered OFF. Unplug the power cable from the power outlet and make sure that the standby power LED is OFF before installing any system component.

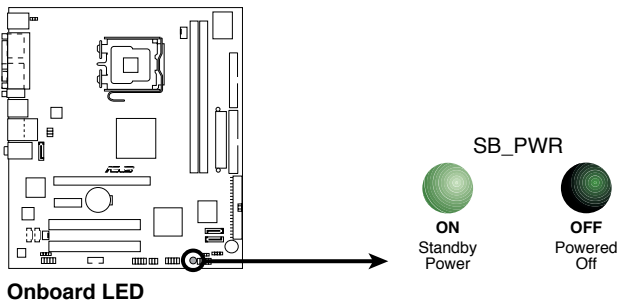

2.3 Removing the side cover and front panel assembly

1. Remove the cover screws on the rear panel.
2. Pull the side cover toward the rear panel until its hooks disengage from the chassis tab holes. Set the side cover aside.
3. Locate the front panel assembly hooks, then lift them until they disengage from the chassis.
4. Swing the front panel assembly to the right, until the hinge-like tabs on the right side of the assembly are exposed.
5. Remove the front panel assembly, then set aside.

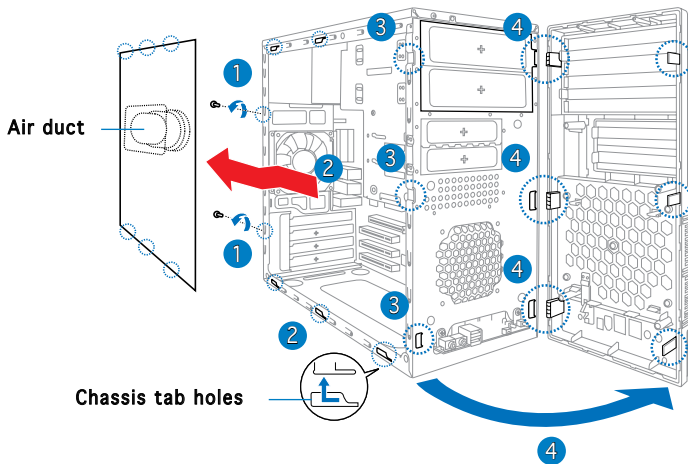

2.4 Central Processing Unit (CPU)

2.4.1 Overview

The motherboard comes with a surface mount LGA775 socket designed for the Intel® Pentium® 4 processor in the 775-land package.



- Your boxed Intel® Pentium® 4 LGA775 processor package should come with installation instructions for the CPU, heatsink, and the retention mechanism. If the instructions in this section do not match the CPU documentation, follow the latter.
- Check your motherboard to make sure that the PnP cap is on the CPU socket and the socket contacts are not bent. Contact your retailer immediately if the PnP cap is missing, or if you see any damage to the PnP cap/socket contacts/motherboard components. ASUS will shoulder the cost of repair only if the damage is shipment/transit-related.
- Keep the cap after installing the motherboard. ASUS will process Return Merchandise Authorization (RMA) requests only if the motherboard comes with the cap on the LGA775 socket.
- The product warranty does not cover damage to the socket contacts resulting from incorrect CPU installation/removal, or misplacement/loss/incorrect removal of the PnP cap.

2.4.2 Installing CPU

To install a CPU:

1. Locate the CPU socket on the motherboard.



Before installing the CPU, make sure that the socket box is facing towards you and the load lever is on your left.

2. Press the load lever with your thumb (A), then move it to the left (B) until it is released from the retention tab.



To prevent damage to the socket pins, do not remove the PnP cap unless you are installing a CPU.

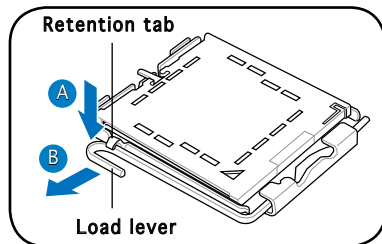

3. Lift the load lever in the direction of the arrow to a 135° angle.
4. Lift the load plate with your thumb and forefinger to a 100° angle (4A), then push the PnP cap from the load plate window to remove (4B).

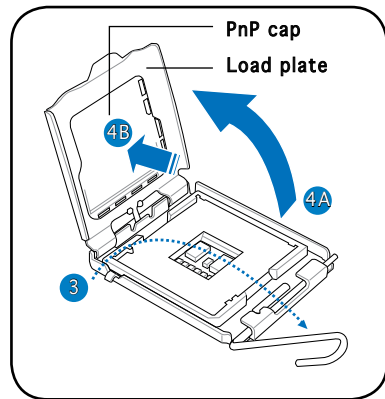

5. Position the CPU over the socket, making sure that the gold triangle is on the bottom-left corner of the socket then fit the socket alignment key into the CPU notch.

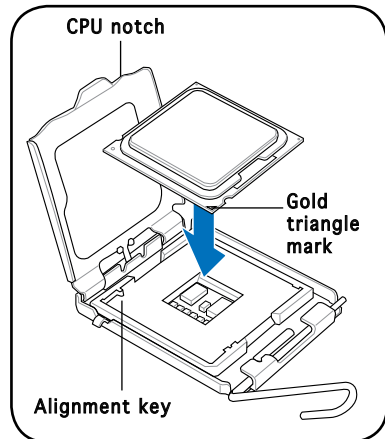

6. Apply Thermal Interface Material on the CPU before closing the load plate.



DO NOT eat the Thermal Interface Material. If it gets into your eyes or touches your skin, make sure to wash it off immediately, and seek professional medical help.

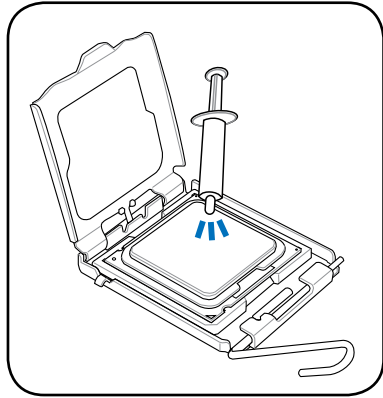

7. Close the load plate (A), then push the load lever (B) until it snaps into the retention tab.

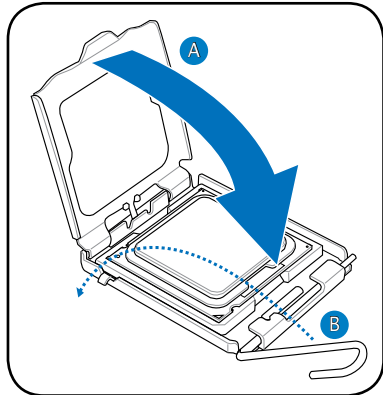

2.4.3 Installing the CPU fan and heatsink assembly

The Intel® Pentium® 4 LGA775 processor requires a specially designed heatsink and fan assembly to ensure optimum thermal condition and performance.



- When you buy a boxed Intel® Pentium® 4 processor, the package includes the CPU fan and heatsink assembly. If you buy a CPU separately, make sure that you use only Intel®-certified multi-directional heatsink and fan.
- Your Intel® Pentium® 4 LGA775 heatsink and fan assembly comes in a push-pin design and requires no tool to install.



If you purchased a separate CPU heatsink and fan assembly, make sure that the Thermal Interface Material is properly applied to the CPU heatsink or CPU before you install the heatsink and fan assembly.

To install the CPU heatsink and fan:

1. Place the heatsink on top of the installed CPU, making sure that the four fasteners match the holes on the motherboard.
2. Push down two fasteners at a time in a diagonal sequence to secure the heatsink and fan assembly in place.

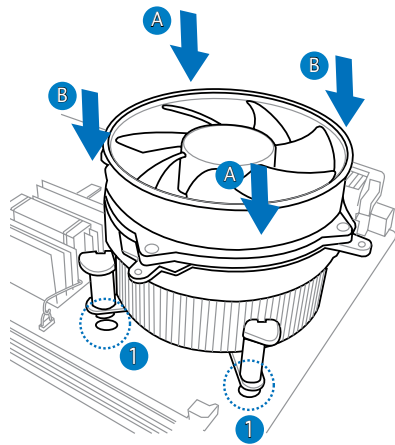
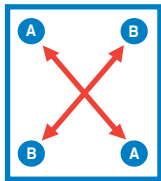

3. When the fan and heatsink assembly is in place, connect the CPU fan cable to the connector on the motherboard.

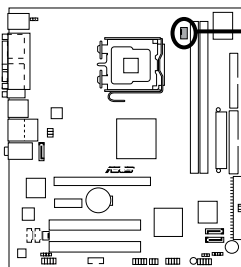

CPU_FAN



CPU Fan Connector



Do not forget to connect the CPU fan connector! Hardware monitoring errors can occur if you fail to plug this connector.

2.5 Installing a DIMM

The system motherboard comes with two Double Data Rate 2 (DDR2) Dual Inline Memory Module (DIMM) sockets.

The following figure illustrates the location of the sockets:

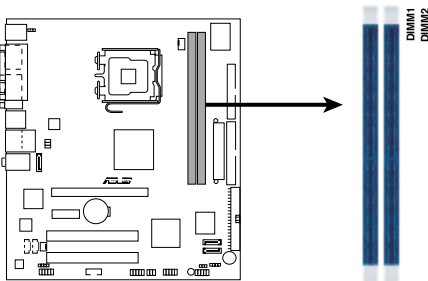

240-pin DDR2 DIMM Sockets

2.5.1 Memory configurations

You may install up to 2 GB system memory using 256 MB, 512 MB, and 1 GB DDR2 DIMMs.



- Install only **identical** (the same type and size) DDR2 memory modules.
- Install only ASUS-certified memory modules. Refer to the DDR2 Qualified Vendors List on the next page for details.
- Always install DIMMs with the same CAS latency. For optimum compatibility, we recommend that you obtain memory modules from the same vendor.

Qualified Vendors Lists (QVL)

DDR2-533

Size	Vendor	Model	CL	Brand	Side(s)	Component	DIMM Support	
							A	B
256 MB	KINGSTON	KVR533D2N4/256	N/A	N/A	SS	E5116AB-5C-E	•	•
512 MB	KINGSTON	KVR533D2N4/512	N/A	N/A	DS	HY5PS56821F-C4	•	•
1024MB	KINGSTON	KVR533D2N4/1G	N/A	N/A	DS	D6408TE7BL-37	•	•
2048 MB	KINGSTON	KVR533D2N4/2G	N/A	N/A	DS	E1108AA-5C-E	•	
256 MB	SAMSUNG	M378T3253FG0-CD5	N/A	N/A	SS	K4T56083QF-GCD5	•	•
512 MB	SAMSUNG	M378T6553BG0-CD5	N/A	N/A	SS	K4T51083QB-GCD5	•	•
512 MB	SAMSUNG	M378T6453FG0-CD5	N/A	N/A	DS	K4T56083QF-GCD5	•	•
512 MB	Infineon	HYS64T64000GU-3.7-A	N/A	N/A	SS	HYB18T512800AC37	•	•
256 MB	Infineon	HYS64T32000HU-3.7-A	N/A	N/A	SS	HYB18T512160AF-3.7	•	
512 MB	Infineon	HYS64T64000HU-3.7-A	N/A	N/A	SS	HYB18T512800AF37	•	•
1024MB	Infineon	HYS64T128020HU-3.7-A	N/A	N/A	DS	HYB18T512800AF37	•	•
2048MB	Infineon	HYS64T256020HU-3.7-A	N/A	N/A	DS	HYB18T1G800AF-3.7	•	
256 MB	Infineon	HYS64T32000HU-3.7-B	N/A	N/A	SS	HYB18T5121608BF-3.7	•	•
512 MB	Infineon	HYS64T64000HU-3.7-B	N/A	N/A	SS	HYB18T512800BF37	•	•
1024MB	Infineon	HYS64T128020HU-3.7-B	N/A	N/A	DS	HYB18T512800BF37	•	•
512 MB	Hynix	HYMP564U648-C4	N/A	N/A	SS	HY5PS12821F-C4	•	
1024MB	Hynix	HYMP512U648-C4	N/A	N/A	DS	HYMP512U648-C4	•	•
512 MB	Hynix	HYMP564U64AP8-C3	N/A	N/A	SS	HY5PS12821AFP-C3	•	
1024MB	Hynix	HYMP512U64AP8-C3	N/A	N/A	DS	HY5PS12821AFP-C3	•	•
512 MB	ELPIDA	EBE51UD8ABFA-5C	N/A	N/A	SS	E5108AB-5C-E	•	•
512 MB	ELPIDA	EBE51UD8ABFA-5C-E	N/A	N/A	SS	E5108AB-5C-E	•	•
1024MB	ELPIDA	EBE11UD8ABFA-5C-E	N/A	N/A	DS	E5108AB-5C-E	•	•
2048MB	ELPIDA	EBE21EE8AAFA-5C-E	N/A	N/A	DS	E1108AA-5C-E	•	
256 MB	CORSAIR	VS256MB533D2	N/A	N/A	SS	MIII0051832M8CEC	•	•
512 MB	CORSAIR	VSS12MB533D2	N/A	N/A	DS	MI110052432M8CEC	•	
256 MB	Apacer	78.81077.420	N/A	N/A	SS	E5116AB-5C-E	•	•
256 MB	KINGMAX	E5116AB-5C-E	N/A	N/A	SS	KLBB68F-36EP4	•	•
512 MB	KINGMAX	E5108AE-5C-E	N/A	N/A	SS	KLBC28F-A8EB4	•	•
1024MB	KINGMAX	E5108AE-5C-E	N/A	N/A	DS	KLBD48F-A8EB4	•	•
512 MB	Transcend	TS64MLQ64V5J	N/A	N/A	SS	K4T51083QB-GCD5	•	
1024MB	Transcend	TS128MLQ64V5J	N/A	N/A	DS	K4T51083QB-GCD5	•	•
256 MB	CENTURY	25V6S8SSD5F4-K43	N/A	N/A	SS	K4T56083QF-GCD5	•	•
1024MB	CENTURY	25V0H8EL5CB4-J45	N/A	N/A	DS	E5108AB-5C-E	•	•
512 MB	Elixir	M2U51264TU88A0F-37B	N/A	N/A	SS	N2TU51280AF-37B	•	
256 MB	Aeneon	AET560UD00-370A98X	N/A	N/A	SS	AET960UD00-37C88X	•	
256 MB	Aeneon	AET560UD00-370A98X	N/A	N/A	SS	AET94F370A	•	•
512 MB	Aeneon	AET660UD00-370A98X	N/A	N/A	SS	AET93F370A	•	•
512 MB	Aeneon	AET760UD00-370A98X	N/A	N/A	DS	AET93F370A	•	•
512 MB	NANYA	NT512T64U88A0F-37B	N/A	N/A	SS	NT5TU64M8AF-37B	•	•
512 MB	PQI	MEAB-423LA	N/A	N/A	SS	64MX8D2-E	•	
1024MB	Patriot	PDC21G5600+XBLK	N/A	N/A	SS	Heat-Sink Package	•	
512 MB	MDT	M512-533-8	N/A	N/A	SS	18D51280D-3.70S20	•	

DDR2-400

Size	Vendor	Model	CL	Brand	Side(s)	Component	DIMM Support	
							A	B
512 MB	KINGSTON	KVR667D2N5/512	N/A	N/A	SS	E5108AE-6E-E	•	•
1024 MB	KINGSTON	KVR667D2N5/1G	N/A	N/A	DS	E5108AE-6E-E	•	•
512 MB	KINGSTON	KVR667D2E5/512	N/A	N/A	SS	E5108AE-6E-E	•	•
256 MB	KINGSTON	KVR667D2N5/256	N/A	N/A	SS	HYB18T5256800AF3	•	•
256 MB	SAMSUNG	M378T3253F20-CE6	N/A	N/A	SS	K4T56083QF-ZCE6	•	•
512 MB	SAMSUNG	M378T6453F20-CE6	N/A	N/A	DS	K4T56083QF-ZCE6	•	•
256 MB	SAMSUNG	M378T3354C20-CE6	N/A	N/A	SS	K4T51163QC-ZCE6	•	•
512 MB	SAMSUNG	M378T6553C20-CE6	N/A	N/A	SS	ZCE6K4T51083QC	•	•
1024 MB	SAMSUNG	M378T2953C20-CE6	N/A	N/A	DS	ZCE6K4T51083QC	•	
256 MB	MICRON	MT8HTF3264AY-667B5	N/A	N/A	SS	4SB42D9CZM	•	•
512 MB	MICRON	MT16HTF6464AY-667B4	N/A	N/A	DS	4VB41D9CZM	•	•
256 MB	Infineon	HYS64T32000HU-3S-A	N/A	N/A	SS	HYB18T512160AF-3S	•	•
512 MB	Infineon	HYS64T64000HU-3S-A	N/A	N/A	SS	HYB18T512800AF3S	•	•
1024 MB	Infineon	HYS64T128020HU-3S-A	N/A	N/A	DS	HYB18T512800AF3S	•	
512 MB	Hynix	HYMP564U64AP8-Y5	N/A	N/A	SS	HY5PS12821AFP-Y5	•	•
1024 MB	Hynix	HYMP512U64AP8-Y5	N/A	N/A	DS	HY5PS12821AFP-Y5	•	•
512 MB	Hynix	HYMP564U64AP8-Y4	N/A	N/A	SS	HY5PS12821AFP-Y4	•	•
1024 MB	Hynix	HYMP512U64AP8-Y4	N/A	N/A	DS	HY5PS12821AFP-Y4	•	•
256 MB	ELPIDA	EBE25UC8ABFA-6E-E	N/A	N/A	SS	E2508AB-GE-E	•	•
512 MB	ELPIDA	EBE51UD8AEFA-6E-E	N/A	N/A	SS	E5108AE-GE-E	•	•
1024 MB	ELPIDA	EBE11UD8AEFA-6E-E	N/A	N/A	DS	Engineering Sample	•	•
512 MB	crucial	BL6464AA664.16FB	N/A	N/A	DS	Heat-Sink Package	•	
1024 MB	crucial	BL12864AA664.16FA	N/A	N/A	DS	Heat-Sink Package	•	•
512 MB	crucial	BL6464AL664.16FB	N/A	N/A	DS	Heat-Sink Package	•	•
1024 MB	crucial	BL12864AL664.16FA	N/A	N/A	DS	Heat-Sink Package	•	•
512 MB	Kingmax	KLCC28F-A8EB5	N/A	N/A	SS	E5108AE-6E-E	•	•
1024 MB	Kingmax	KLCD48F-A8EB5	N/A	N/A	DS	E5108AE-6E-E	•	
512 MB	Apacer	78.91092.420	N/A	N/A	SS	E5108AE-6E-E	•	
1024 MB	Apacer	78.01092.420	N/A	N/A	DS	E5108AE-6E-E	•	
512 MB	A-DATA	M20EL5G3H3160B1COZ	N/A	N/A	SS	E5108AE-6E-E	•	•
512 MB	TwinMOS	8G-25JK5-EBT	N/A	N/A	SS	E5108AE-GE-E	•	•
512 MB	GEIL	GX21GB5300UDC	N/A	N/A	SS	Heat-Sink Package	•	•
512 MB	GEIL	GX21GB5300DC	N/A	N/A	SS	Heat-Sink Package	•	•
256 MB	NANYA	NT256T64UH4A0FY-3C	N/A	N/A	SS	NT5TU32M16AG-3C	•	
512 MB	NANYA	NT512T64U88A0BY-3C	N/A	N/A	SS	NT5TU64M8AE-3C	•	
512 MB	OCZ	OCZ26671024EBDCPE-K	N/A	N/A	SS	Heat-Sink Package	•	•
1024 MB	WINTEC	39137282	N/A	N/A	DS	4WAIID9CWX	•	
512 MB	MDT	M512-667-8	N/A	N/A	SS	18D51280D-30518	•	•
1024 MB	MDT	M924-667-16	N/A	N/A	DS	18D51280D-30528	•	

Side(s): SS - Single-sided DS - Double-sided

CL: CAS Latency

DIMM support:

- A** - Supports one module inserted into either slot, in Single-channel memory configuration.
- B** - Supports one pair of modules inserted into both slots as one pair of Dual-channel memory configuration.

2.5.2 Installing a DDR2 DIMM



Make sure to unplug the power supply before adding or removing DIMMs or other system components. Failure to do so may cause severe damage to both the motherboard and the components.

1. Unlock a DDR2 DIMM socket by pressing the retaining clips outward.
2. Align a DIMM on the socket such that the notch on the DIMM matches the break on the socket.

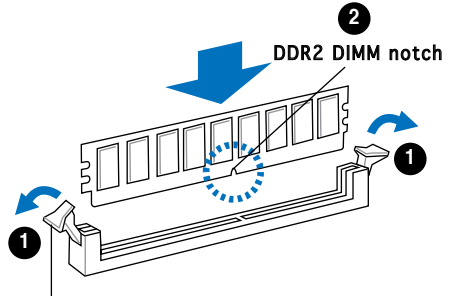

Unlocked retaining clip



A DDR2 DIMM is keyed with a notch so that it fits in only one direction. **DO NOT** force a DIMM into a socket to avoid damaging the DIMM.

3. Firmly insert the DIMM into the socket until the retaining clips snap back in place and the DIMM is properly seated.

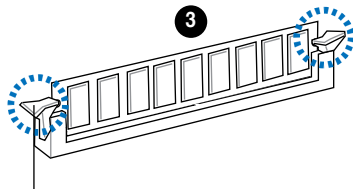

Locked Retaining Clip

2.5.3 Removing a DDR2 DIMM

Follow these steps to remove a DIMM.

1. Simultaneously press the retaining clips outward to unlock the DIMM.

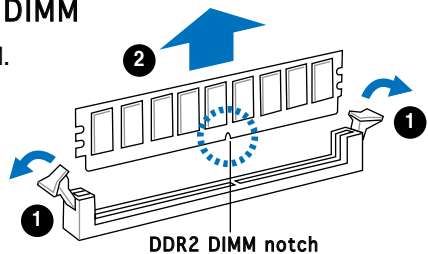

Support the DIMM lightly with your fingers when pressing the retaining clips. The DIMM might get damaged when it flips out with extra force.

2. Remove the DIMM from the socket.

2.6 Expansion slots

In the future, you may need to install expansion cards. The following sub-sections describe the slots and the expansion cards that they support.



Make sure to unplug the power cord before adding or removing expansion cards. Failure to do so may cause you physical injury and damage motherboard components.

2.6.1 Installing an expansion card

To install an expansion card:

1. Before installing the expansion card, read the documentation that came with it and make the necessary hardware settings for the card.
2. Remove the system unit cover (if your motherboard is already installed in a chassis).
3. Remove the bracket opposite the slot that you intend to use. Keep the screw for later use.
4. Align the card connector with the slot and press firmly until the card is completely seated on the slot.
5. Secure the card to the chassis with the screw you removed earlier.
6. Replace the system cover.

2.6.2 Configuring an expansion card

After installing the expansion card, configure it by adjusting the software settings.

1. Turn on the system and change the necessary BIOS settings, if any. See Chapter 5 for information on BIOS setup.
2. Assign an IRQ to the card. Refer to the tables on the next page.
3. Install the software drivers for the expansion card.

Standard interrupt assignments

IRQ	Standard Function
0	System Timer
1	Keyboard Controller
2	Re-direct to IRQ#9
4	Communications Port (COM1)*
5	IRQ holder for PCI steering*
6	Floppy Disk Controller
7	Printer Port (LPT1)*
8	System CMOS/Real Time Clock
9	IRQ holder for PCI steering*
10	IRQ holder for PCI steering*
11	IRQ holder for PCI steering*
12	PS/2 Compatible Mouse Port*
13	Numeric Data Processor
14	Primary IDE Channel
15	Secondary IDE Channel

* These IRQs are usually available for ISA or PCI devices.

IRQ assignments for this motherboard

	A	B	C	D	E	F	G	H
PCI slot 1	shared	—	—	—	—	—	—	—
PCI slot 2	—	shared	—	—	—	—	—	—
PCI Express x16 slot	shared	—	—	—	—	—	—	—
PCI Express x1 slot	—	shared	—	—	—	—	—	—
Onboard USB controller 1	—	—	—	—	—	—	—	shared
Onboard USB controller 2	—	—	—	shared	—	—	—	—
Onboard USB controller 3	—	—	shared	—	—	—	—	—
Onboard USB controller 4	—	—	—	shared	—	—	—	—
Onboard USB 2.0 controller	—	—	—	—	—	—	—	shared
Onboard IDE port	—	—	—	shared	—	—	—	—
Onboard HD audio	shared	—	—	—	—	—	—	—
Onboard LAN	—	shared	—	—	—	—	—	—



When using PCI cards on shared slots, ensure that the drivers support “Share IRQ” or that the cards do not need IRQ assignments. Otherwise, conflicts will arise between the two PCI groups, making the system unstable and the card inoperable.

2.6.3 PCI Express x1 slot

This motherboard supports PCI Express x1 network cards, SCSI cards and other cards that comply with the PCI Express specifications. The figure shows a network card installed on the PCI Express x1 slot.

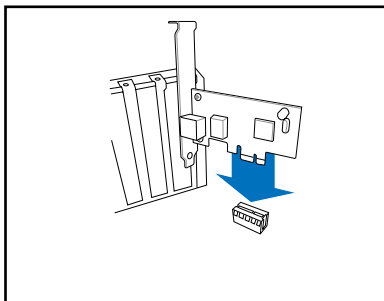

2.6.4 PCI slots

The PCI slots support cards such as a LAN card, SCSI card, USB card, and other cards that comply with PCI specifications. The figure shows a LAN card installed on a PCI slot.

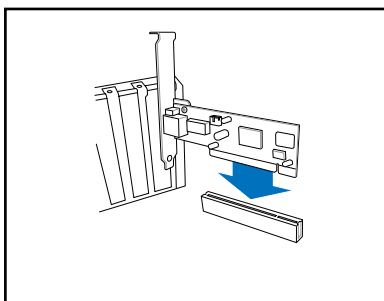

2.6.5 PCI Express x16 slot

This motherboard supports PCI Express x16 graphic cards that comply with the PCI Express specifications. The figure shows a graphics card installed on the PCI Express x16 slot.

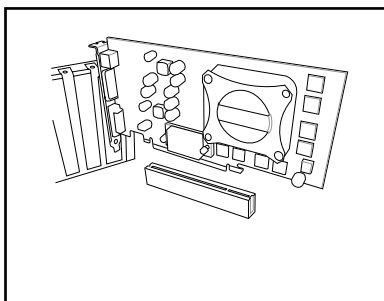

2.7 Installing an optical drive

Refer to the instructions in this section if you wish to install a new optical drive.

Follow these steps to install an optical drive:

1. Place the chassis upright.
2. Remove the drive slot metal plate cover.
3. Insert the optical drive into the upper 5.25-inch drive bay and carefully push the optical drive into the bay until its screw holes align with the holes on the bay as shown.
4. Secure the optical drive with two screws on both sides of the bay.

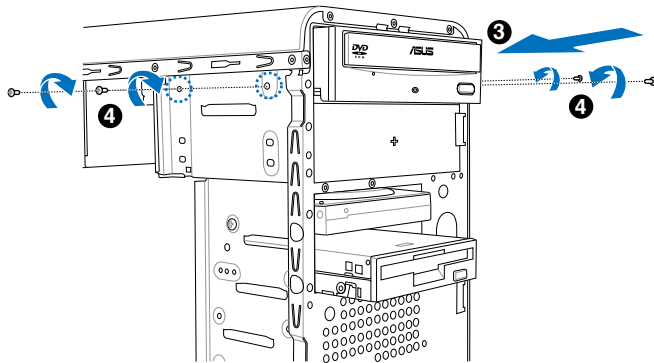

5. Connect a power cable from the power supply to the power connector at the back of the optical drive.
6. Connect one end of the IDE ribbon cable to the IDE interface at the back of the optical drive, matching the red stripe on the cable with Pin 1 on the IDE interface.

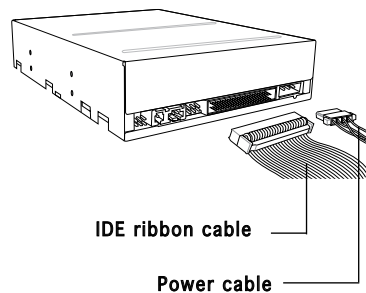

7. Connect the other end of the IDE ribbon cable to the secondary IDE connector (labeled SEC_IDE) on the motherboard. See page 4-7 for the location of this connector.
8. Remove the dummy drive slot cover from the front panel.
9. Replace the front panel.

2.8 Installing a hard disk drive

The system may have one pre-installed 3.5-inch Serial ATA or IDE hard disk drive. Refer to this section to install additional Serial ATA or IDE hard disk drive(s).

To install a Serial ATA hard disk drive:

1. Place the chassis upright.
2. Use a screw driver to remove the HDD drive slot metal plate cover.

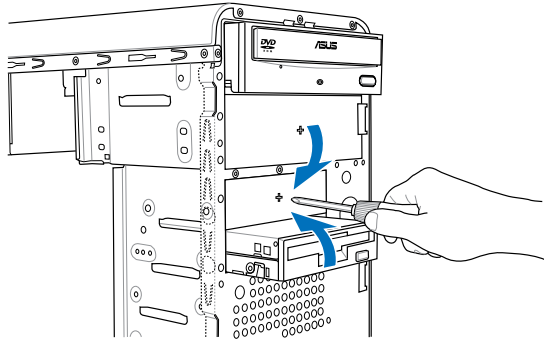

3. With the HDD label side up, carefully insert the drive into the 3.5-inch bay and push the drive into the bay until its screw holes align with the holes on the drive bay.

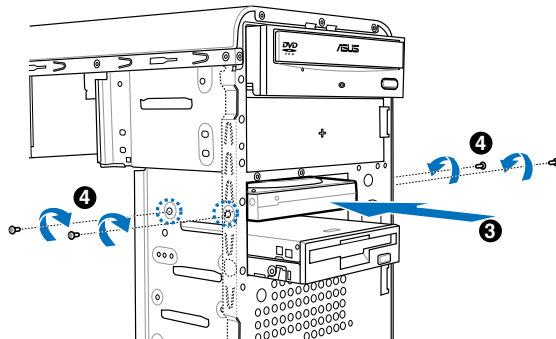

4. Secure the drive with two screws on both sides.

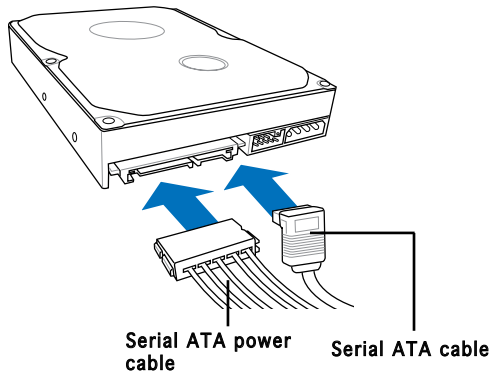

5. Connect one end of the Serial ATA cable to the SATA connector at the back of the drive, then connect the other end to a Serial ATA connector on the motherboard. See page 4-6 for the location of the Serial ATA connectors.
6. Connect a 15-pin Serial ATA power plug from the power supply unit to the 15-pin power connector at the back of the drive.

- OR -

Connect a 4-pin (female) power plug from the power supply unit to the 4-pin (male) power connector at the back of the drive.



If your Serial ATA HDD has both 4-pin and 15-pin connectors at the back, use either the 15-pin SATA power adapter plug **OR** the legacy 4-pin power connector. **DO NOT** use both to prevent damage to components and to keep the system from becoming unstable.

To install an IDE hard disk drive:

1. Follow steps 1-4 of the previous section.
2. Connect the blue interface of the IDE ribbon cable to the primary IDE connector (blue connector labeled PRI_IDE) on the motherboard. See page 4-7 for the location of the connector.

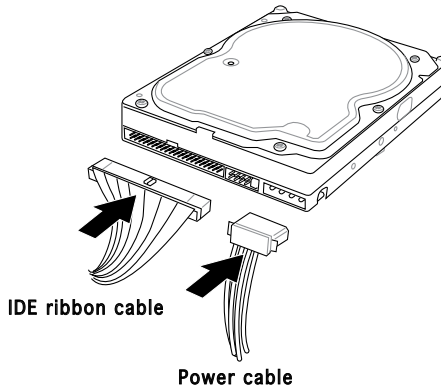

- If you will install only one hard disk drive, make sure to configure your hard disk drive as Master device before connecting the IDE cable and power plug. Refer to the HDD documentation on how to set the drive as a Master device.
- If you will install two IDE hard disk drives, configure the other device as Slave.

3. Connect the gray interface of the IDE ribbon cable to the IDE connector on the drive.
4. If you install two IDE hard disk drives, connect the black interface of the IDE ribbon cable to the IDE connector on the second (Slave) IDE hard disk drive.
5. Connect a 4-pin power plug from the power supply unit to the power connector at the back of the drive(s).

2.9 Installing a floppy disk drive

The Vintage2-PE2 system comes with one 3.25-inch drive bay for a floppy disk drive.

To install a floppy disk drive:

1. Remove the front panel cover.
2. Carefully insert the floppy disk drive into the floppy drive bay until the screw holes align with the holes on the bay.
3. Secure the floppy disk drive with two screws on both sides.

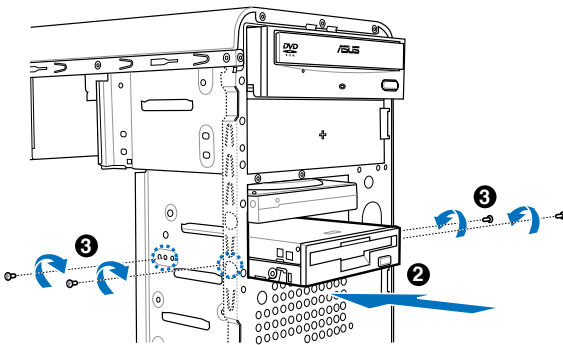

4. Connect the floppy disk drive signal cable to the signal connector at the back of the drive.

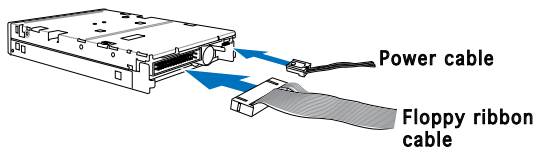

5. Connect the other end of the signal cable to the floppy disk drive connector on the motherboard. See page 4-6 for the location of the floppy disk drive connector.
6. Connect a 4-pin power cable from the power supply unit to the power connector at the back of the floppy disk drive.

2.10 Re-connecting cables

You may have disconnected some cables when you were installing components. You must re-connect these cables before you replace the chassis cover.

LED cables

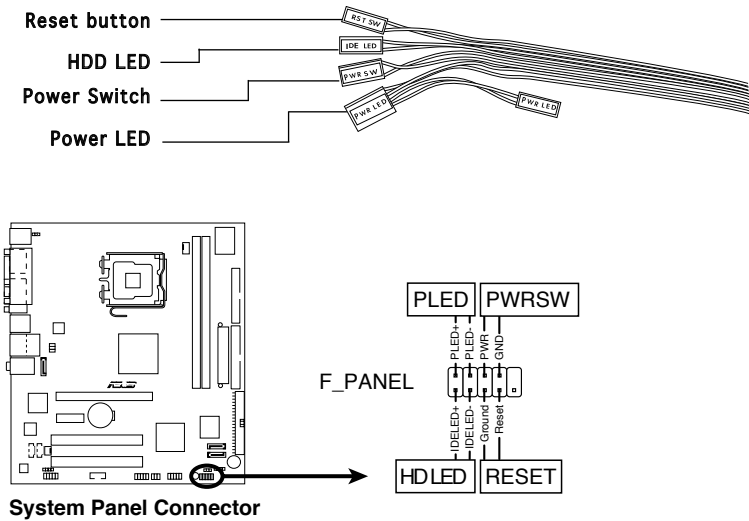

Connect the **reset button**, **power switch**, **power LED**, and **HDD LED** cables to their respective leads in the system panel connector on the motherboard.

2.11 Removing the bay covers and reinstalling the front panel assembly and side cover

If you installed an optical and/or floppy disk drive, remove the bay cover(s) on the front panel assembly before reinstalling it to the chassis. To do this:

1. Locate the bay cover locks.
2. Press the locks outward to release the bay cover.
3. Push the bay cover inward, then set it aside.
4. Follow the same instructions to remove the 3.5" drive bay cover.

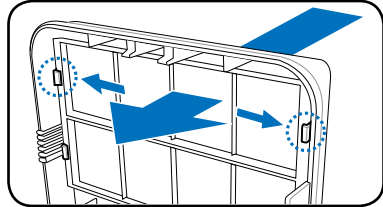

To reinstall the front panel assembly and side cover:

1. Insert the front panel assembly hinge-like tabs to the holes on the right side of the chassis.
2. Swing the front panel assembly to the left, then insert the hooks to the chassis until the front panel assembly fits in place.
3. Insert the six side cover hooks into the chassis tab holes .
4. Push the side cover to the direction of the front panel until it fits in place.
5. Secure the cover with two screws you removed earlier.



If the air duct interferes with the CPU fan, adjust the air duct accordingly.

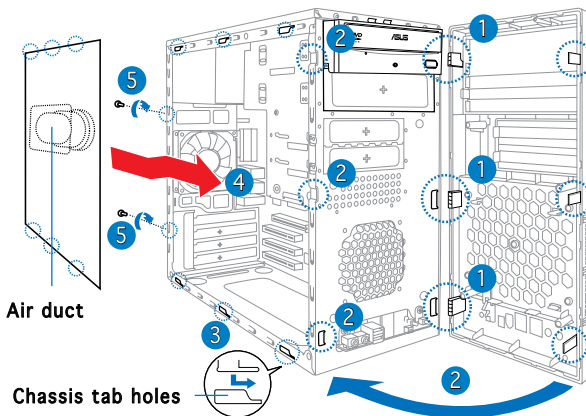

Chapter 3

This chapter helps you power up the system and install drivers and utilities from the support CD.

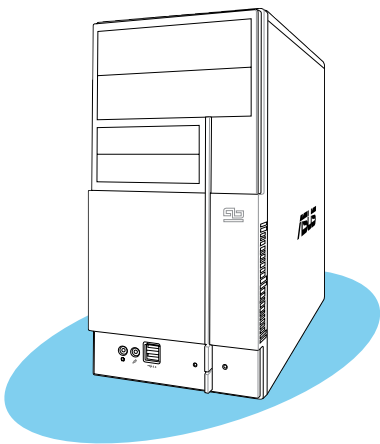

Starting up

3.1 Installing an operating system

The barebone system supports Windows® 2000/XP operating systems (OS). Always install the latest OS version and corresponding updates so you can maximize the features of your hardware.



Because motherboard settings and hardware options vary, use the setup procedures presented in this chapter for general reference only. Refer to your OS documentation for more information.



- Windows XP OS setup cannot recognize Serial ATA hard drives without the necessary drivers. Use the bundled floppy disk when installing Windows XP OS to a Serial ATA hard drive.
- From the Windows XP setup screen, press F6 when prompted then follow succeeding screen instructions to install the SATA drivers.

3.2 Powering up

Press the system power button (⏻) to enter the OS.

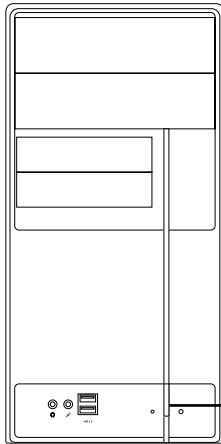

Press to turn ON the system

3.3 Support CD information

The support CD that came with the system contains useful software and several utility drivers that enhance the system features.



- Screen display and driver options may not be the same for different operating system versions.
- The contents of the support CD are subject to change at any time without notice. Visit the ASUS website for updates.

3.3.1 Running the support CD

To begin using the support CD, place the CD in your optical drive. The CD automatically displays the **Drivers** menu if Autorun is enabled in your computer.



Click an icon to display support CD/motherboard information

Click an item to install



If **Autorun** is NOT enabled in your computer, browse the contents of the support CD to locate the file **ASSETUP.EXE** from the BIN folder. Double-click the **ASSETUP.EXE** to run the CD.

ASUS InstAll - Installation Wizard for Drivers

Automatically installs all the necessary drivers for this motherboard.

VIA 4 in 1 Drivers

Installs the VIA 4 in 1 driver.

VIA/S3G UniChrome Family Display Driver

Installs the VIA/S3G UniChrome Family Display Driver.

SoundMAX ADI1986A Audio Driver

Installs the SoundMAX AD1986A Audio Driver. Before install the HD audio (AZALIA) driver, you need to install Microsoft HD UAA Bus driver

JMicron JMB36X RAID Controller Driver

Installs the JMicron JMB36X RAID Controller Driver.

VIA Rhine Family Fast Ethernet Adapter Driver

Installs the VIA Rhine Family Fast Ethernet Adapter Driver.

3.3.2 Utilities menu

The Utilities menu shows the applications and other software that the motherboard supports.



ASUS InstAll-Installation Wizard for Utilities

Installs the ASUS InstAll-Installation Wizard Utilities.

ASUS PC Probe II

This smart utility monitors the fan speed, CPU temperature, and system voltages, and alerts you of any detected problems. This utility helps you keep your computer in healthy operating condition.

ASUS Update

The ASUS Update utility allows you to update the motherboard BIOS in a Windows® environment. This utility requires an Internet connection either through a network or an Internet Service Provider (ISP). See page 5-8 for details.

ASUS Screen Saver

Installs the ASUS screen saver.

Adobe Reader V7.0

Installs the Adobe® Acrobat® Reader V7.0 that allows you to open, view, and print documents in Portable Document Format (PDF).

Microsoft DirectX 9.0c Driver

Installs the Microsoft® DirectX 9.0c driver.

3.2.3 Make Disk



VIA RAID Driver Disk

Installs the VIA RAID Driver Disk

Make JMicron JMB36X 32/64bit RAID Driver

Installs the Make JMicron JMB36X 32/64bit RAID Driver.

3.3.4 ASUS Contact information

Click the **Contact** tab to display the ASUS contact information. You can also find this information on the inside front cover of this user guide.



3.4 Software information

Most of the applications in the support CD have wizards that will conveniently guide you through the installation. View the online help or readme file that came with the software for more information.

ASUS PC Probe II

PC Probe II is a utility that monitors the computer's vital components and alerts you of any problem with these components. PC Probe II senses fan rotations, CPU temperature, and system voltages, among others. PC Probe II is software-based, allowing you to start monitoring your computer the moment you turn it on. With this utility, you are assured that your computer is always at a healthy operating condition.

Installing PC Probe II

To install PC Probe II on your computer:

1. Place the support CD to the optical drive. The **Drivers** installation tab appears if your computer has an enabled Autorun feature.



If Autorun is not enabled in your computer, browse the contents of the support CD to locate the setup.exe file from the ASUS PC Probe II folder. Double-click the setup.exe file to start installation.

2. Click the **Utilities** tab, then click **ASUS PC Probe II**.
3. Follow the screen instructions to complete installation.

Launching PC Probe II

You can launch the PC Probe II right after installation or anytime from the Windows® desktop.

To launch the PC Probe II from the Windows® desktop, click **Start > All Programs > ASUS > PC Probe II**. The PC Probe II main window appears.

After launching the application, the PC Probe II icon appears in the Windows® taskbar. Click this icon to close or restore the application.











Click to close the Preference panel

Using PC Probe II

Main window

The PC Probe II main window allows you to view the current status of your system and change the utility configuration. By default, the main window displays the **Preference** section. You can close or restore the **Preference** section by clicking on the triangle on the main window right handle.

Button	Function
	Opens the Configuration window
	Opens the Report window
	Opens the Desktop Management Interface window
	Opens the Peripheral Component Interconnect window
	Opens the Windows Management Instrumentation window
	Opens the hard disk drive, memory, CPU usage window
	Shows/Hides the Preference section
	Minimizes the application
	Closes the application

Sensor alert

When a system sensor detects a problem, the main window right handle turns red, as the illustrations below show.



When displayed, the monitor panel for that sensor also turns red. Refer to the **Monitor panels** section for details.

Preferences

You can customize the application using the Preference section in the main window. Click the box before each preference to activate or deactivate.

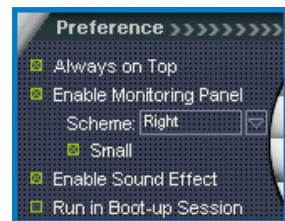

Hardware monitor panels

The hardware monitor panels display the current value of a system sensor such as fan rotation, CPU temperature, and voltages.

The hardware monitor panels come in two display modes: hexagonal (large) and rectangular (small). When you check the **Enable Monitoring Panel** option from the **Preference** section, the monitor panels appear on your computer's desktop.



Large display



Small display

Changing the monitor panels position

To change the position of the monitor panels on the desktop, click the arrow down button of the **Scheme** options, then select another position from the list box. Click **OK** when finished.



Moving the monitor panels

All monitor panels move together using a magnetic effect. If you want to detach a monitor panel from the group, click the horseshoe magnet icon. You can now move or reposition the panel independently.

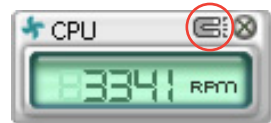

Adjusting the sensor threshold value

You can adjust the sensor threshold value in the monitor panel by clicking the arrow buttons. You can also adjust the threshold values using the **Config** window.

You cannot adjust the sensor threshold values in a small monitoring panel.

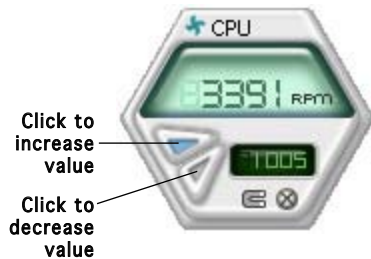

Monitoring sensor alert

The monitor panel turns red when a component value exceeds or is lower than the threshold value. Refer to the illustrations below.



Large display



Small display

WMI browser

Click **WMI** to display the WMI (Windows Management Instrumentation) browser. This browser displays various Windows® management information. Click an item from the left panel to display on the right panel. Click the plus sign (+) before **WMI Information** to display the available information.



You can enlarge or reduce the browser size by dragging the bottom right corner of the browser.

DMI browser

Click **DMI** to display the DMI (Desktop Management Interface) browser. This browser displays various desktop and system information. Click the plus sign (+) before **DMI Information** to display the available information.



PCI browser

Click **PCI** to display the PCI (Peripheral Component Interconnect) browser. This browser provides information on the PCI devices installed on your system. Click the plus sign (+) before the **PCI Information** item to display available information.



Usage

The **Usage** browser displays real-time information on the CPU, hard disk drive space, and memory usage. Click **USAGE** to display the Usage browser.

CPU usage

The **CPU** tab displays real-time CPU usage in line graph representation. If the CPU has an enabled Hyper-Threading, two separate line graphs display the operation of the two logical processors.



Hard disk drive space usage

The **Hard Disk** tab displays the used and available hard disk drive space. The left panel of the tab lists all logical drives. Click a hard disk drive to display the information on the right panel. The pie chart at the bottom of the window represents the used (blue) and the available HDD space.

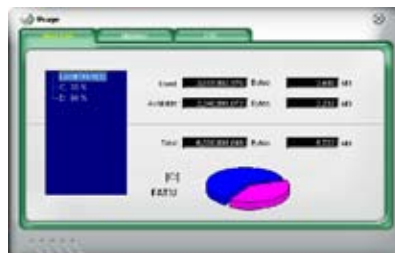

Memory usage

The **Memory** tab shows both used and available physical memory. The pie chart at the bottom of the window represents the used (blue) and the available physical memory.



Configuring PC Probe II

Click **CONFIG** to view and adjust the sensor threshold values.

The **Config** window has two tabs: **Sensor/Threshold** and **Preference**. The **Sensor/Threshold** tab enables you to activate the sensors or to adjust the sensor threshold values. The **Preference** tab allows you to customize sensor alerts, change temperature scale, or enable the Q-Fan feature.



Loads the default threshold values for each sensor

Applies your changes

Cancels or ignores your changes

Loads your saved configuration
 Saves your configuration

Chapter 4

This chapter gives information about the motherboard that comes with the system. This chapter includes the motherboard layout, jumper settings, and connector locations.

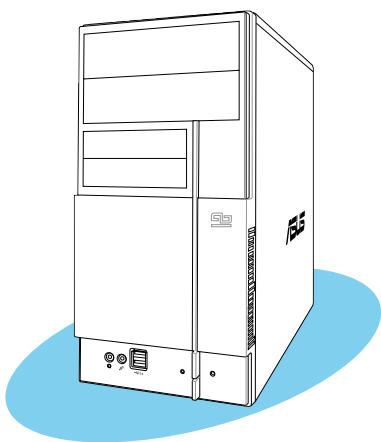

Motherboard introduction

4.1 Introduction

The Vintage V2-PE2 barebone system comes with an ASUS motherboard. This chapter provides technical information about the motherboard for future upgrades or system reconfiguration.

4.2 Motherboard layout

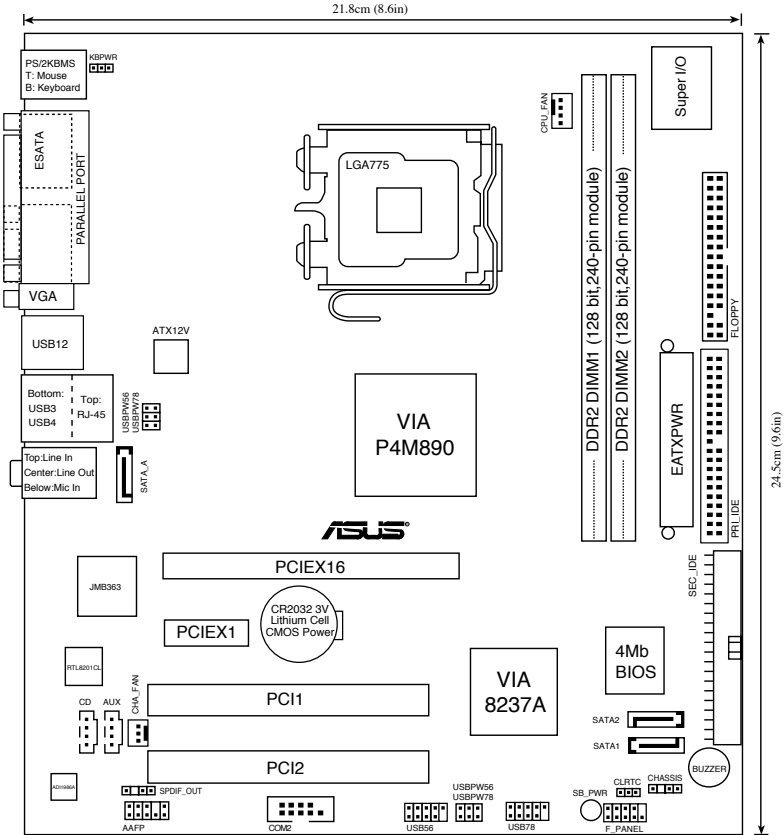

4.3 Jumpers

1. Clear RTC RAM (CLRRTC)

This jumper allows you to clear the Real Time Clock (RTC) RAM in CMOS. You can clear the CMOS memory of date, time, and system setup parameters by erasing the CMOS RTC RAM data. The onboard button cell battery powers the RAM data in the CMOS, which includes the system setup information such as system passwords.

To erase the RTC RAM:

1. Turn OFF the computer and unplug the power cord.
2. Remove the battery.
3. Move the jumper cap from pins 1-2 (default) to pins 2-3. Keep the cap on pins 2-3 for about 5-10 seconds, then move the cap back to pins 1-2.
4. Re-install the battery.
5. Plug the power cord and turn ON the computer.
6. Hold down the key during the boot process and enter BIOS setup to re-enter data.

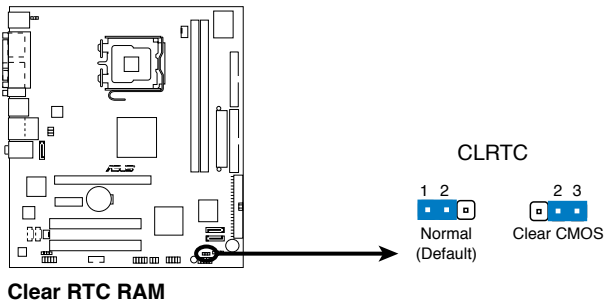

Except when clearing the RTC RAM, never remove the cap on CLRRTC jumper default position. Removing the cap will cause system boot failure.

2. USB device wake-up (3-pin USBPW12, USBPW34, USBPW56, USBPW78)

Set these jumpers to +5V to wake up the computer from S1 sleep mode (CPU stopped, DRAM refreshed, system running in low power mode) using the connected USB devices. Set to +5VSB to wake up from S3 and S4 sleep modes (no power to CPU, DRAM in slow refresh, power supply in reduced power mode).

The USBPWR12 and USBPWR34 jumpers are for the rear USB ports. The USBPWR56 and USBPWR78 jumper is for the internal USB connectors that you can connect to additional USB ports.

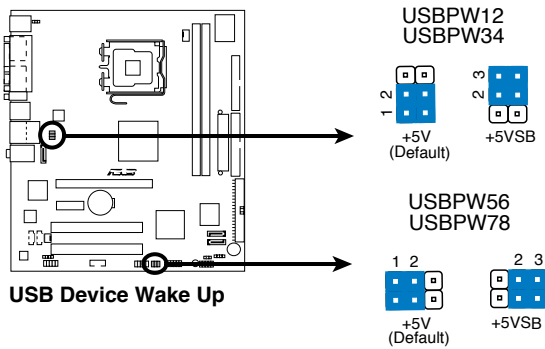

- The USB device wake-up feature requires a power supply that can provide 500mA on the +5VSB lead for each USB port; otherwise, the system would not power up.
- The total current consumed must NOT exceed the power supply capability (+5VSB) whether under normal condition or in sleep mode.

3. Keyboard power (3-pin KBPWR)

This jumper allows you to enable or disable the keyboard wake-up feature. Set this jumper to pins 2-3 (+5VSB) if you wish to wake up the computer when you press a key on the keyboard (the default is the Space Bar). This feature requires an ATX power supply that can supply at least 1A on the +5VSB lead, and a corresponding setting in the BIOS.

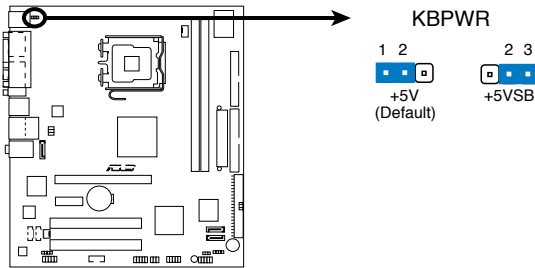

Keyboard Power Setting

4.4 Connectors

1. Floppy disk drive connector (34-1 pin FLOPPY)

This connector is for the provided floppy disk drive (FDD) signal cable. Insert one end of the cable to this connector, then connect the other end to the signal connector at the back of the floppy disk drive.



Pin 5 on the connector is removed to prevent incorrect cable connection when using a FDD cable with a covered Pin 5.

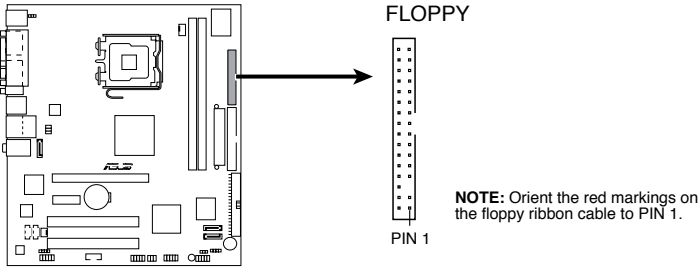

Floppy Disk Drive Connector

2. Serial ATA connectors (7-pin SATA1, SATA2)

These connectors are for the Serial ATA signal cables for Serial ATA hard disk drives.

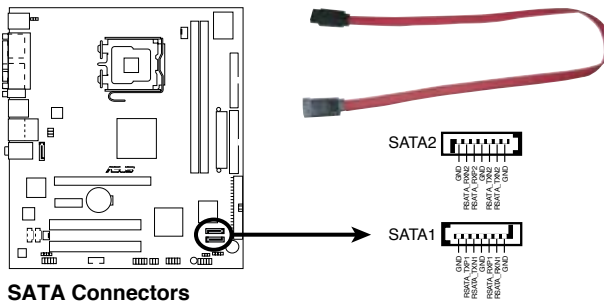

SATA Connectors



Important notes on Serial ATA:

- You must install Windows® 2000 Service Pack 4 or the Windows® XP Service Pack 1 before using Serial ATA hard disk drives.
- When using the connectors in **Standard IDE** mode, connect the primary (boot) hard disk drive to the SATA1 or SATA2 connector.

3 IDE connectors (40-1 pin PRI_IDE, SEC_IDE)

The onboard IDE connectors are for Ultra DMA 133/100/66 signal cable(s). There are three connectors on each Ultra DMA 133/100/66 signal cable: blue, black, and gray. Connect the blue connector to the motherboard's IDE connector, then select one of the following modes to configure your device(s).

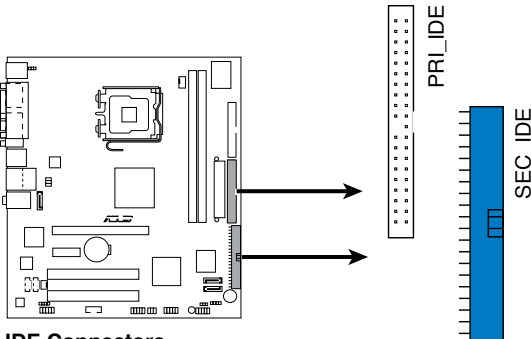

NOTE: Orient the red markings (usually zigzag) on the ID ribbon cable to PIN 1.

IDE Connectors

	Drive jumper setting	Mode Cable of device(s)	Cable connector
Single device	Cable-Select or Master	-	Black
Two devices	Cable-Select	Master Slave	Black Gray
	Master Slave	Master Slave	Black or gray



- Pin 20 on the IDE connector is removed to match the covered hole on the Ultra DMA cable connector. This prevents incorrect insertion when you connect the IDE cable.
- Use the 80-conductor IDE cable for Ultra DMA 133/100/66 IDE devices.



If any device jumper is set as "Cable-Select", make sure all other device jumpers have the same setting.

4. CPU and Chassis Fan connectors (4-pin CPU_FAN, 3-pin CHA_FAN)

The fan connectors support cooling fans of 350 mA~740 mA (8.88 W max.) or a total of 1 A~2.22 A (26.64 W max.) at +12V. Connect the fan cables to the fan connectors on the motherboard, making sure that the black wire of each cable matches the ground pin of the connector.

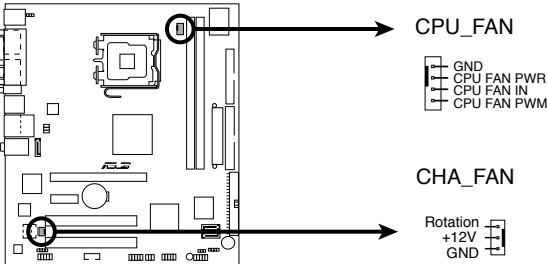

Fan Connectors



Do not forget to connect the fan cables to the fan connectors. Insufficient air flow inside the system may damage the motherboard components. These are not jumpers! Do not place jumper caps on the fan connectors!

5. USB connectors (10-1 pin USB56, USB78)

These connectors are for USB 2.0 ports. Connect the USB/GAME module cable to any of these connectors, then install the module to a slot opening at the back of the system chassis. These USB connectors comply with USB 2.0 specification that supports up to 480 Mbps connection speed.

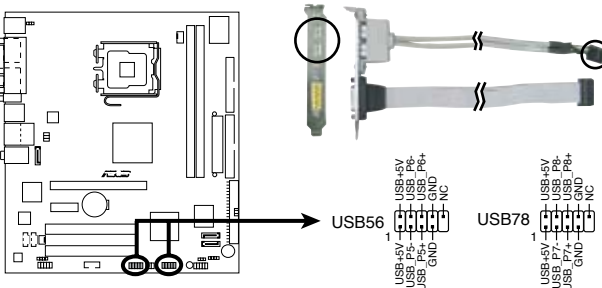

USB2.0 Connectors



Never connect a **1394 cable** to the USB connectors. Doing so will damage the motherboard!



The USB module is purchased separately.

6. ATX power connectors (24-pin EATXPWR, 4-pin ATX12V)

These connectors are for ATX power supply plugs. The plugs from the power supply are designed to fit these connectors in only one orientation. Find the proper orientation and push down firmly until the connectors completely fit.

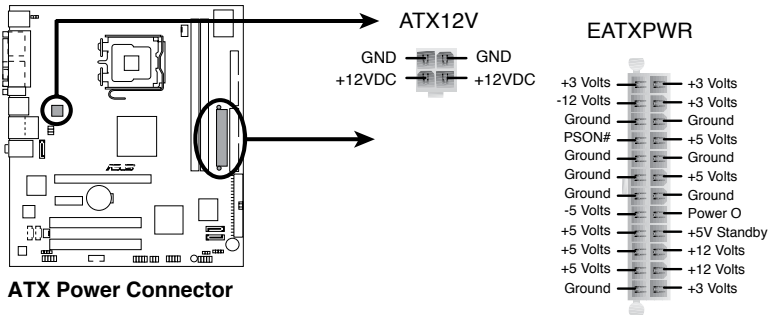

- Do not forget to connect the 4-pin ATX +12 V power plug; otherwise, the system will not boot.
- Use of a PSU with a higher power output is recommended when configuring a system with more power-consuming devices. The system may become unstable or may not boot up if the power is inadequate.
- Make sure that your power supply unit (PSU) can provide at least the minimum power required by your system.

7. Internal audio connectors (4-pin CD, 4-pin AUX)

These connectors allow you to receive stereo audio input from sound sources such as a CD-ROM, TV tuner, or MPEG card.

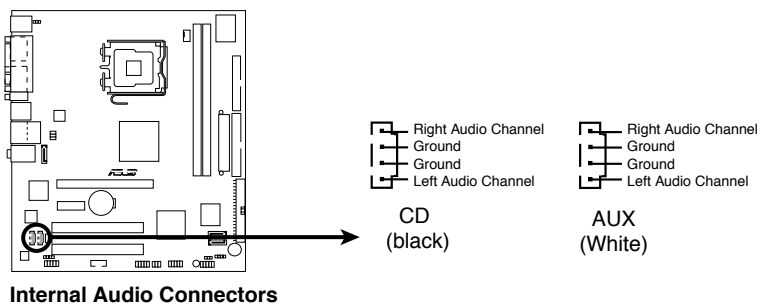

Enable the CD-IN function in the audio utility when using this connector.

8. Front panel audio connector (10-1 pin AAFP)

This connector is for a chassis-mounted front panel audio I/O module that supports either HD Audio or legacy AC'97 audio standard.

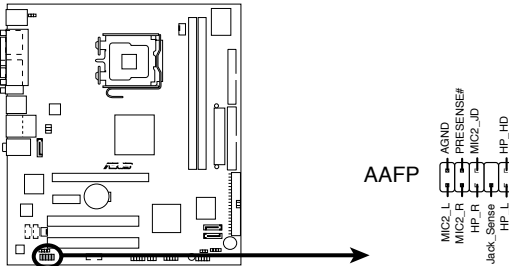

Azalia Analog Front Panel Connector



We recommend that you connect a high-definition front panel audio module to this connector to avail of the motherboard's high-definition audio capability.

9. Digital audio connector (4-1 pin SPDIF_OUT)

This connector is for an additional Sony/Philips Digital Interface (S/PDIF) port(s). Connect the S/PDIF module cable to this connector, then install the module to a slot opening at the back of the system chassis.

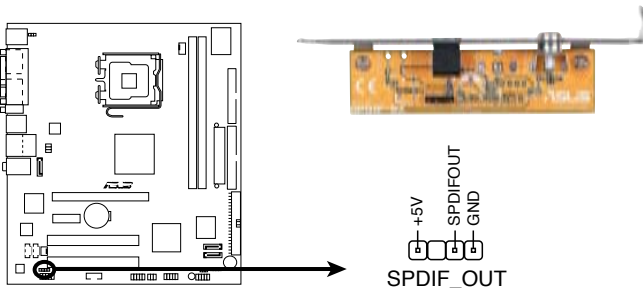

Digital Audio Connector



The S/PDIF module is purchased separately.

10. Chassis intrusion connector (4-1 pin CHASSIS)

This connector is for a chassis-mounted intrusion detection sensor or switch. Connect one end of the chassis intrusion sensor or switch cable to this connector. The chassis intrusion sensor or switch sends a high-level signal to this connector when a chassis component is removed or replaced. The signal is then generated as a chassis intrusion event.

By default, the pins labeled “Chassis Signal” and “Ground” are shorted with a jumper cap. Remove the jumper cap only when you intend to use the chassis intrusion detection feature.

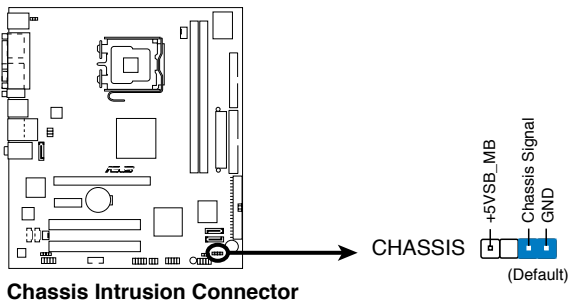

11. Serial port connector (10-1 pin COM2)

This connector is for a serial (COM) port. Connect the serial port module cable to this connector, then install the module to a slot opening at the back of the system chassis.

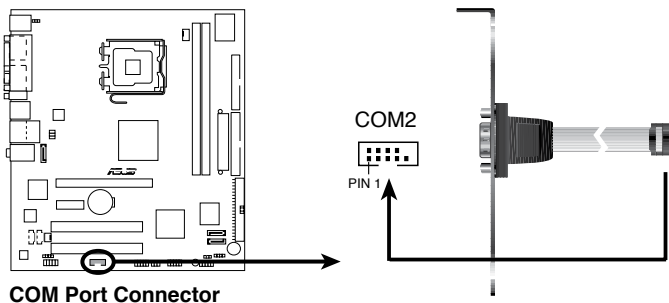

12. System panel connector (10-1 pin PANEL)

This connector supports several chassis-mounted functions.

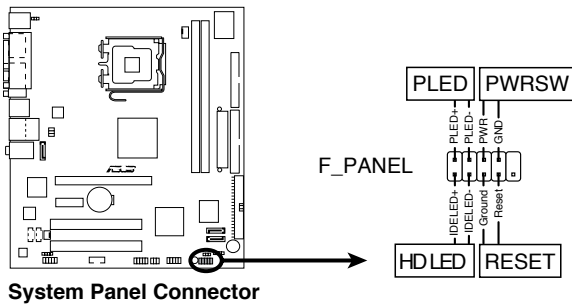

The system panel connector is color-coded for easy connection. Refer to the connector description below for details.

- **System power LED (2-pin PLED)**
This 2-pin connector is for the system power LED. Connect the chassis power LED cable to this connector. The system power LED lights up when you turn on the system power, and blinks when the system is in sleep mode.
- **Hard disk drive activity (2-pin HDLED)**
This 2-pin connector is for the HDD Activity LED. Connect the HDD Activity LED cable to this connector. The IDE LED lights up or flashes when data is read from or written to the HDD.
- **Power/Soft-off button (2-pin PWRSW)**
This connector is for the system power button. Pressing the power button turns the system ON or puts the system in SLEEP or SOFT-OFF mode depending on the BIOS settings. Pressing the power switch for more than four seconds while the system is ON turns the system OFF.
- **Reset button (2-pin RESET)**
This 2-pin connector is for the chassis-mounted reset button for system reboot without turning off the system power.

Chapter 5

This chapter tells how to change system settings through the BIOS Setup menus and describes the BIOS parameters.



BIOS setup

5.1 Managing and updating your BIOS

The following utilities allow you to manage and update the motherboard Basic Input/Output System (BIOS) setup.

1. ASUS Update (Updates the BIOS in Windows® environment)
2. ASUS EZ Flash (Updates the BIOS during the Power-On Self Test)
3. Award BIOS Flash Utility (Updates the BIOS in DOS mode)
4. ASUS CrashFree BIOS 2 (Updates the BIOS when the BIOS file fails or gets corrupted.)

Refer to the corresponding sections for details on these utilities.



Save a copy of the original motherboard BIOS file to a bootable floppy disk in case you need to restore the BIOS in the future. Copy the original motherboard BIOS using the ASUS Update or Award BIOS Flash utilities.

5.1.1 ASUS Update utility

The ASUS Update is a utility that allows you to manage, save, and update the motherboard BIOS in Windows® environment. The ASUS Update utility allows you to:

- Save the current BIOS file
- Download the latest BIOS file from the Internet
- Update the BIOS from an updated BIOS file
- Update the BIOS directly from the Internet, and
- View the BIOS version information.

This utility is available in the support CD that comes with the motherboard package.



ASUS Update requires an Internet connection either through a network or an Internet Service Provider (ISP).

Installing ASUS Update

To install ASUS Update:

1. Place the support CD in the optical drive. The Drivers menu appears.
2. Click the Utilities tab, then click Install ASUS Update VX.XX.XX.
3. The ASUS Update utility is copied to your system.



Quit all Windows® applications before you update the BIOS using this utility.

Updating the BIOS through the Internet

To update the BIOS through the Internet:

1. Launch the ASUS Update utility from the Windows® desktop by clicking Start > Programs > ASUS > ASUSUpdate > ASUSUpdate. The ASUS Update main window appears.

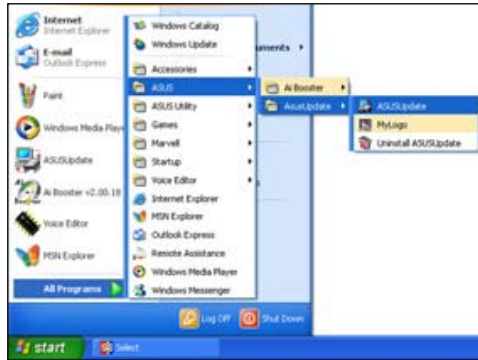

2. Select **Update BIOS** from the Internet option from the drop-down menu, then click **Next**.



3. Select the ASUS FTP site nearest you to avoid network traffic, or click Auto Select. Click **Next**.

- From the FTP site, select the BIOS version that you wish to download. Click **Next**.
- Follow the screen instructions to complete the update process.



The ASUS Update utility is capable of updating itself through the Internet. Always update the utility to avail all its features.



Updating the BIOS through a BIOS file

To update the BIOS through a BIOS file:

- Launch the ASUS Update utility from the Windows® desktop by clicking Start > Programs > ASUS > ASUSUpdate > ASUSUpdate. The ASUS Update main window appears.
- Select Update BIOS from a file option from the drop-down menu, then click Next.



- Locate the BIOS file from the Open window, then click Open.
- Follow the screen instructions to complete the update process.



5.1.2 Creating a bootable floppy disk

1. Do either one of the following to create a bootable floppy disk.

DOS environment

- a. Insert a 1.44MB floppy disk into the drive.
- b. At the DOS prompt, type *format a: /s* then press <Enter>.

Windows® XP environment

- a. Insert a 1.44 MB floppy disk to the floppy disk drive.
- b. Click Start from the Windows® desktop, then select My Computer.
- c. Select the 3 1/2 Floppy Drive icon.
- d. Click File from the menu, then select Format. A Format 3 1/2 Floppy Disk window appears.
- e. Select Create an MS-DOS startup disk from the format options field, then click Start.

Windows® 2000 environment

To create a set of boot disks for Windows® 2000:

- a. Insert a formatted, high density 1.44 MB floppy disk into the drive.
- b. Insert the Windows® 2000 CD to the optical drive.
- c. Click Start, then select Run.
- d. From the Open field, type
`D:\bootdisk\makeboot a:`
assuming that D: is your optical drive.
- e. Press <Enter>, then follow screen instructions to continue.

2. Copy the original or the latest motherboard BIOS file to the bootable floppy disk.

5.1.3 ASUS EZ Flash utility

The ASUS EZ Flash feature allows you to update the BIOS without having to go through the long process of booting from a floppy disk and using a DOS-based utility. The EZ Flash utility is built-in the BIOS chip so it is accessible by pressing <Alt> + <F2> during the Power-On Self Tests (POST).

To update the BIOS using EZ Flash 2:

1. Download the latest BIOS file from ASUS website (www.asus.com), or obtain it from the support CD.
2. Save the BIOS file to a floppy disk, then boot the system from floppy disk.
3. Press <Alt> + <F2> during POST, the following screen appears:

```
EZFlash starting BIOS update
Checking for floppy...
```

4. Insert the floppy disk that contains the BIOS file to the floppy disk drive. When the correct BIOS file is found, EZ Flash performs the BIOS update process and automatically reboots the system when done.



Do not shut down or reset the system while updating the BIOS to prevent system boot failure!

5.1.4 AwardBIOS Flash Utility

The Basic Input/Output System (BIOS) can be updated using the AwardBIOS Flash Utility. Follow these instructions to update the BIOS using this utility.

1. Download the latest BIOS file from the ASUS web site. Rename the file to P5VD2MX.BIN and save it to a floppy disk.



Save only the updated BIOS file in the floppy disk to avoid loading the wrong BIOS file.

2. Copy the AwardBIOS Flash Utility (awdfash.exe) from the Software folder of the support CD to the floppy disk with the latest BIOS file.
3. Boot the system in DOS mode using the bootable floppy disk you created earlier.
4. When the A:> appears, replace the bootable floppy disk with the floppy disk containing the new BIOS file and the Award BIOS Flash Utility.
5. At the prompt, type awdfash then press <Enter>. The Award BIOS Flash Utility screen appears.

```
AwardBIOS Flash Utility for ASUS V1.17
(C) Phoenix Technologies Ltd. All Rights Reserved

For P4M890-8237A-P5VD2-MX      DATE:05/04/2006
Flash Type - SST 49LF004B LPC (4MB)

File Name to Program: P5VD2MX.bin

Message: Please input File Name!
```

6. Type the BIOS file name in the File Name to Program field, then press <Enter>.

```
AwardBIOS Flash Utility for ASUS V1.17
(C) Phoenix Technologies Ltd. All Rights Reserved

For P4M890-8237A-P5VD2-MX      DATE:05/04/2006
Flash Type - SST 49LF004B LPC (4MB)

File Name to Program: P5VD2MX.bin

Message: Do You Want To Save Bios (Y/N)
```

- Press <N> when the utility prompts you to save the current BIOS file. The following screen appears.
- The utility verifies the BIOS file in the floppy disk and starts flashing the BIOS file.

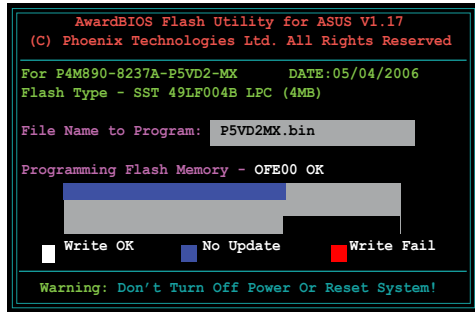

Do not turn off or reset the system during the flashing process!

- The utility displays a Flashing Complete message indicating that you have successfully flashed the BIOS file. Remove the floppy disk then press <F1> to restart the system.

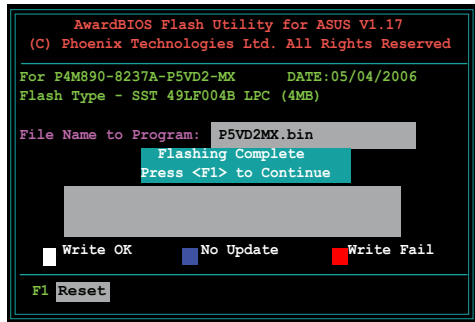

5.1.5 Saving the current BIOS file

You can use the AwardBIOS Flash Utility to save the current BIOS file. You can load the current BIOS file when the BIOS file gets corrupted during the flashing process.



Make sure that the floppy disk has enough disk space to save the file.

To save the current BIOS file using the AwardBIOS Flash Utility:

1. Follow steps 1 to 6 of the previous section.
2. Press <Y> when the utility prompts you to save the current BIOS file. The following screen appears.

```
AwardBIOS Flash Utility for ASUS V1.17
(C) Phoenix Technologies Ltd. All Rights Reserved

For P4M890-8237A-P5VD2-MX      DATE:05/04/2006
Flash Type - SST 49LF004B LPC (4MB)

File Name to Program: P5VD2MX.bin
Save current BIOS as: _____

Message:
```

3. Type a filename for the current BIOS file in the Save current BIOS as field, then press <Enter>.

```
AwardBIOS Flash Utility for ASUS V1.17
(C) Phoenix Technologies Ltd. All Rights Reserved

For P4M890-8237A-P5VD2-MX      DATE:05/04/2006
Flash Type - SST 49LF004B LPC (4MB)

File Name to Program: P5VD2MX.bin
Checksum: _____
Save current BIOS as: _____

Message: Please Wait!
```

4. The utility saves the current BIOS file to the floppy disk, then returns to the BIOS flashing process.

```
AwardBIOS Flash Utility for ASUS V1.17
(C) Phoenix Technologies Ltd. All Rights Reserved

For P4M890-8237A-P5VD2-MX      DATE:05/04/2006
Flash Type - SST 49LF004B LPC (4MB)

File Name to Program: P5VD2MX.bin
Now Backup System BIOS to
File!
_____

Message: Please Wait!
```

5.1.6 ASUS CrashFree BIOS 2 utility

The ASUS CrashFree BIOS 3 is an auto recovery tool that allows you to restore the BIOS file when it fails or gets corrupted during the updating process. You can update a corrupted BIOS file using the motherboard support CD or the floppy disk that contains the updated BIOS file.



Prepare the motherboard support CD or the floppy disk containing the updated motherboard BIOS before using this utility.

Recovering the BIOS from the support CD

To recover the BIOS from the support CD:

1. Turn on the system.
2. Insert the motherboard support CD to the optical drive.
3. The utility displays the following message and automatically checks the CD for the BIOS file.

```
Award BootBlock BIOS v1.0  
Copyright (c) 2000, Award Software, Inc.
```

```
BIOS ROM checksum error  
Detecting IDE ATAPI device...
```

When found, the utility reads the BIOS file and starts flashing the corrupted BIOS file.

```
Award BootBlock BIOS v1.0  
Copyright (c) 2000, Award Software, Inc.
```

```
BIOS ROM checksum error  
Detecting IDE ATAPI device...  
Found CDR0M, try to Boot from it... Pass
```



DO NOT shut down or reset the system while updating the BIOS! Doing so can cause system boot failure!

4. Restart the system after the utility completes the updating process.

5.2 BIOS setup program

This motherboard supports a programmable Low-Pin Count (LPC) chip that you can update using the provided utility described in section “4.1 Managing and updating your BIOS.”

Use the BIOS Setup program when you are installing a motherboard, reconfiguring your system, or prompted to “Run Setup.” This section explains how to configure your system using this utility.

Even if you are not prompted to use the Setup program, you can change the configuration of your computer in the future. For example, you can enable the security password feature or change the power management settings. This requires you to reconfigure your system using the BIOS Setup program so that the computer can recognize these changes and record them in the CMOS RAM of the LPC chip.

The LPC chip on the motherboard stores the Setup utility. When you start up the computer, the system provides you with the opportunity to run this program. Press during the Power-On Self-Test (POST) to enter the Setup utility; otherwise, POST continues with its test routines.

If you wish to enter Setup after POST, reboot the system by doing any of the following procedures:

- Restart using the OS standard shut-down procedure.
- Press <Ctrl>+<Alt>+ simultaneously.
- Press the reset button on the system chassis.
- Press the power button to turn the system off then back on.



Using the power button, reset button, or the <Ctrl>+<Alt>+ keys to force reset from a running operating system can cause damage to the data or system. We recommend to always shut-down the system properly from the operating system.

The Setup program is designed to make it as easy to use as possible. Being a menu-driven program, it lets you scroll through the various sub-menus and make your selections from the available options using the navigation keys.



-
- The default BIOS settings for this motherboard apply for most conditions to ensure optimum performance. If the system becomes unstable after changing any BIOS settings, load the default settings to ensure system compatibility and stability. Select the Load Default Settings item under the Exit Menu.
 - The BIOS setup screens shown in this section are for reference purposes only, and may not exactly match what you see on your screen.
 - Visit the ASUS website (www.asus.com) to download the latest BIOS file for this motherboard.
-

5.2.1 BIOS menu screen

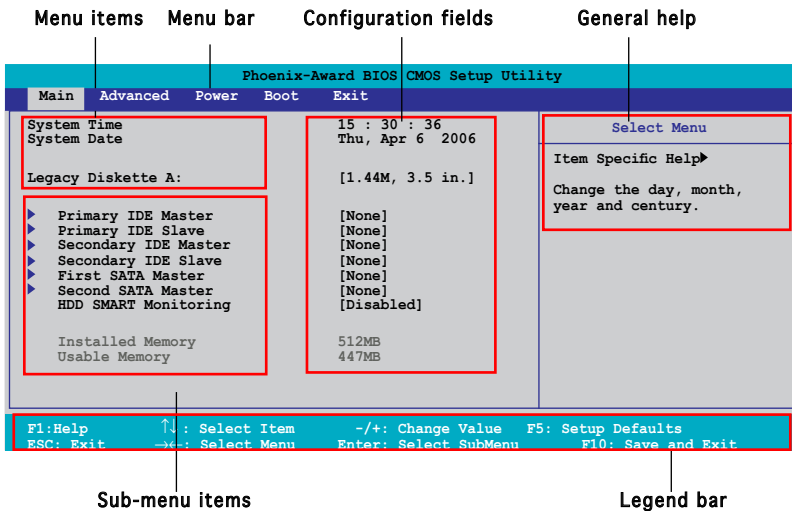

5.2.2 Menu bar

The menu bar on top of the screen has the following main items:

- | | |
|----------|--|
| Main | For changing the basic system configuration |
| Advanced | For changing the advanced system settings |
| Power | For changing the advanced power management (APM) configuration |
| Boot | For changing the system boot configuration |
| Exit | For selecting the exit options and loading default settings |

To select an item on the menu bar, press the right or left arrow key on the keyboard until the desired item is highlighted.



- The BIOS setup screens shown in this chapter are for reference purposes only, and may not exactly match what you see on your screen.
- Visit the ASUS website (www.asus.com) to download the latest BIOS information.

5.2.3 Legend bar

At the bottom of the Setup screen is a legend bar. The keys in the legend bar allow you to navigate through the various setup menus. The following table lists the keys found in the legend bar with their corresponding functions.

Navigation Key	Function
<F1>	Displays the General Help screen
<F5>	Loads setup default values
<Esc>	Exits the BIOS setup or returns to the main menu from a sub-menu
Left or Right arrow	Selects the menu item to the left or right
Up or Down arrow	Moves the highlight up or down between fields
Page Down or - (minus)	Scrolls backward through the values for the highlighted field
Page Up or + (plus)	Scrolls forward through the values for the highlighted field
<Enter>	Brings up a selection menu for the highlighted field
<F10>	Saves changes and exit

5.2.4 Menu items

The highlighted item on the menu bar displays the specific items for that menu. For example, selecting Main shows the Main menu items.

The other items (Advanced, Power, Boot, and Exit) on the menu bar have their respective menu items.

5.2.5 Sub-menu items

A solid triangle before each item on any menu screen means that the item has a sub-menu. To display the sub-menu, select the item and press <Enter>.

5.2.6 Configuration fields

These fields show the values for the menu items. If an item is user-configurable, you can change the value of the field opposite the item. You cannot select an item that is not user-configurable.

A configurable field is enclosed in brackets, and is highlighted when selected. To change the value of a field, select it then press <Enter> to display a list of options.

5.2.7 Pop-up window

Select a menu item then press <Enter> to display a pop-up window with the configuration options for that item.

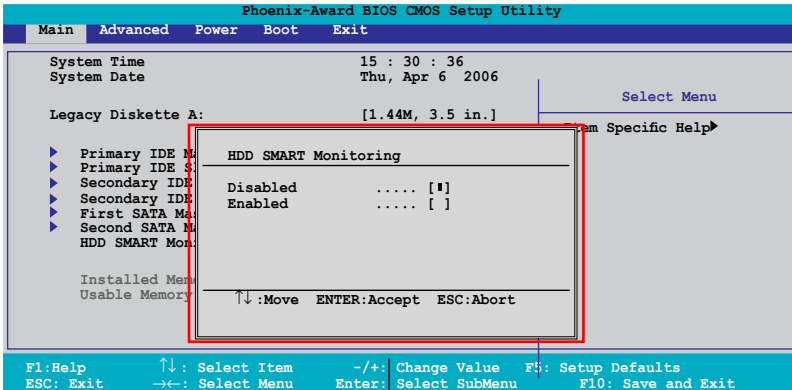

Pop-up menu

5.2.8 General help

At the top right corner of the menu screen is a brief description of the selected item.

5.3 Main menu

When you enter the BIOS Setup program, the Main menu screen appears, giving you an overview of the basic system information.



Refer to section “4.2.1 BIOS menu screen” for information on the menu screen items and how to navigate through them.

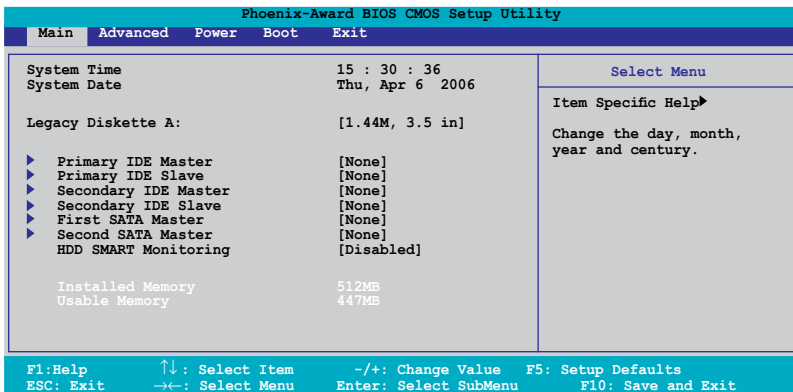

5.3.1 System Time [xx:xx:xx]

Allows you to set the system time.

5.3.2 System Date [Day xx/xx/xxxx]

Allows you to set the system date.

5.3.5 Primary IDE Master/Slave

While entering Setup, the BIOS automatically detects the presence of IDE devices. There is a separate sub-menu for each IDE device. Select a device item then press <Enter> to display the IDE device information.

Phoenix-Award BIOS CMOS Setup Utility		
Main		
Primary IDE Master		Select Menu
Primary IDE Master	[Auto]	Item Specific Help▶▶ Press [Enter] to select.
Access Mode	[Auto]	
Capacity	0 MB	
Cylinder	0	
Head	0	
Sector	0	
PIO Mode	[Auto]	
UDMA Mode	[Auto]	
Transfer Mode	None	
F1: Help ↑↓: Select Item -/+ : Change Value F5: Setup Defaults ESC: Exit →←: Select Menu Enter: Select SubMenu F10: Save and Exit		

The BIOS automatically detects the values opposite the dimmed items (Capacity, Cylinder, Head, Sector and Transfer Mode). These values are not user-configurable. These items show N/A if no IDE device is installed in the system.

PIO Mode [Auto]

Sets the PIO mode for the IDE device.

Configuration options: [Auto] [Mode 0] [Mode 1] [Mode 2] [Mode 3] [Mode 4]

UDMA Mode [Auto]

Disables or sets the UDMA mode. Configuration options: [Disabled] [Auto]

Primary IDE Master/Slave [Auto]

Select [Auto] to automatically detect an IDE hard disk drive. If automatic detection is successful, the BIOS automatically fills in the correct values for the remaining fields on this sub-menu. If the hard disk was already formatted on a previous system, the setup BIOS may detect incorrect parameters. Select [Manual] to manually enter the IDE hard disk drive parameters. If no drive is installed select [None]. Configuration options: [None] [Auto] [Manual]

Access Mode [Auto]

The default [Auto] allows automatic detection of an IDE hard disk drive. Select [CHS] for this item if you set the IDE Primary Master/Slave to [Manual]. Configuration options: [CHS] [LBA] [Large] [Auto]



Before attempting to configure a hard disk drive, make sure you have the correct configuration information supplied by the drive manufacturer. Incorrect settings may cause the system to fail to recognize the installed hard disk.

Capacity

Displays the auto-detected hard disk capacity. This item is not configurable.

Cylinder

Shows the number of the hard disk cylinders. This item is not configurable.

Head

Shows the number of the hard disk read/write heads. This item is not configurable.

Sector

Shows the number of sectors per track. This item is not configurable.

Transfer Mode

Shows the Transfer mode. This item is not configurable.



After entering the IDE hard disk drive information into BIOS, use a disk utility, such as FDISK, to partition and format new IDE hard disk drives. This is necessary so that you can write or read data from the hard disk. Make sure to set the partition of the Primary IDE hard disk drives to active.

5.3.6 First / Second SATA Master

While entering Setup, the BIOS automatically detects the presence of Serial ATA devices. There is a separate sub-menu for each SATA device. Select a device item then press <Enter> to display the SATA device information.

Phoenix-Award BIOS CMOS Setup Utility		
Main		
First SATA Master		Select Menu
Extended IDE Drive Access Mode	[Auto] [Auto]	Item Specific Help▶▶ Selects the type of fixed disk connected to the system.
Capacity	0 MB	
Cylinder	0	
Head	0	
Landing Zone	0	
Sector	0	
F1: Help ↑↓: Select Item -/+ : Change Value F5: Setup Defaults ESC: Exit →←: Select Menu Enter: Select SubMenu F10: Save and Exit		

The BIOS automatically detects the values opposite the dimmed items (Capacity, Cylinder, Head, Landing Zone and Sector). These values are not user-configurable. These items show 0 if no SATA device is installed in the system.

Extended IDE Drive [Auto]

Selects the type of fixed disk connected to the system.

Configuration options: [None] [Auto]

Access Mode [Auto]

Sets the sector addressing mode. Configuration options: [Large] [Auto]



Before attempting to configure a hard disk drive, make sure you have the correct configuration information supplied by the drive manufacturer. Incorrect settings may cause the system to fail to recognize the installed hard disk.

Capacity

Displays the auto-detected hard disk capacity. This item is not configurable.

Cylinder

Shows the number of the hard disk cylinders. This item is not configurable.

Head

Shows the number of the hard disk read/write heads. This item is not configurable.

Landing Zone

Shows the number of landing zone per track. This item is not configurable.

Sector

Shows the number of sectors per track. This item is not configurable.



After entering the IDE hard disk drive information into BIOS, use a disk utility, such as FDISK, to partition and format new IDE hard disk drives. This is necessary so that you can write or read data from the hard disk. Make sure to set the partition of the Primary IDE hard disk drives to active.

5.3.7 HDD SMART Monitoring [Disabled]

Allows you to enable or disable the HDD Self-Monitoring Analysis and Reporting Technology (SMART) feature. Configuration options: [Disabled] [Enabled]

5.3.8 Installed Memory [xxx MB]

Shows the size of installed memory.

5.3.9 Usable Memory [XXX MB]

Shows the size of usable memory.

5.4 Advanced menu

The Advanced menu items allow you to change the settings for the CPU and other system devices.



Take caution when changing the settings of the Advanced menu items. Incorrect field values can cause the system to malfunction.

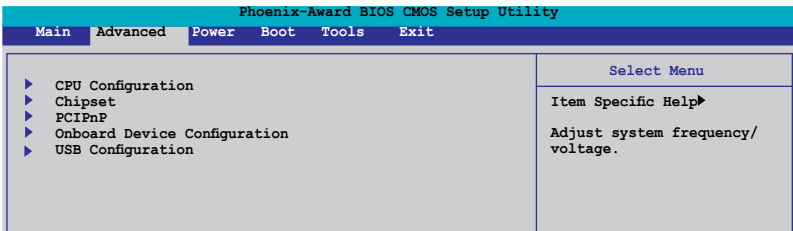

5.4.1 CPU Configuration

Phoenix-Award BIOS CMOS Setup Utility	
Advanced	
CPU Configuration	Select Menu
CPU Type	Intel Genuine Processor
CPU Speed	3.80GHz
Cache RAM	2048K
Current FSB Frequency	200MHz
Delay Prior to Thermal	[4 Min]
Thermal Management	[TM 1]
TM2 Bus Ratio	14 X
TM2 Bus VID	0.8375V
Limit CPUID MaxVal	[Disabled]
Enhanced C1 (C1E)	[Enabled]
Execute Disable Bit	[Enabled]
Enhanced Intel SpeedStep(tm) Tech.	[Disabled]
CPU L1 & L2 Cache	[Enabled]
Hyper-Threading TEchnology	[Enabled]

Thermal Management [TM 1]

Configuration options: [TM 1] [TM 2]. Thermal Monitor 1: On die throttling; Thermal Monitor 2: Ratio & VID transition

Limit CPUID MaxVal [Disabled]

Configuration options: [Disabled] [Enabled].

Enhanced C1 (C1E) [Enabled]

The process will lower the core to bus ratio and VID when physical process enter an enhance C1 state. Configuration options: [Disabled] [Enabled].

Execute Disable Bit [Enabled]

When disabled, forces the XD feature flag to always return 0. Configuration options: [Disabled] [Enabled].

Enhanced Intel SpeedStep(tm) Tech. [Disabled]

Enable this function for adjusting CPU speed according to CPU workload. Configuration options: [Disabled] [Enabled].

CPU L1&L2 Cache [Enabled]

Configuration options: [Disabled] [Enabled].

Hyper-Treading Technology [Enabled]

Set to [Enable] when using Windows XP and Linux 2.4.X, set to [Disabled] when using other OS.

5.4.2 Chipset

Phoenix-Award BIOS CMOS Setup Utility			
Advanced			
Chipset		Select Menu	
▶ DRAM Clock/Drive Control ▶ Frequency/Voltage control Top Performance [Disabled] Primary Display Adapter [PCI-E] VGA Share Memory Size [64M]		Item Specific Help▶▶▶	
F1: Help	↑↓: Select Item	-/+ : Change Value	F5: Setup Defaults
ESC: Exit	→←: Select Menu	Enter: Select Sub-menu	F10: Save and Exit

DRAM Clock/Drive Control

Phoenix-Award BIOS CMOS Setup Utility			
Advanced			
DRAM Clock/Drive Control		Select Menu	
Current DRAM Frequency 266MHz DRAM Clock [By SPD] DRAM Timing [Auto By SPD] SDRAM CAS Latency [DDR/DDR2] 2.5/4 Bank Interleave Disabled Precharge to Active (Trp) 4T Active to Precharge (Tras) 07T Active to CMD (Trcd) 4T REF to ACT/REF 20T/21T ACT (0) to ACT (1) 3T		Item Specific Help▶▶▶	
F1: Help	↑↓: Select Item	-/+ : Change Value	F5: Setup Defaults
ESC: Exit	→←: Select Menu	Enter: Select Sub-menu	F10: Save and Exit

DRAM Clock [By SPD]

Sets the DRAM clock. Configuration options: [By SPD] [200 MHz] [266 MHz].

DRAM Timing [Auto By SPD]

Sets the DRAM Timing. Configuration options: [Manual] [Auto by SPD] [Turbo] [Ultra].

Frequency/voltage control

Phoenix-Award BIOS CMOS Setup Utility	
Advanced	
Frequency/Voltage control	Select Menu
CPU Clock Ratio [19 X]	Item Specific Help▶▶▶
Async CPU/PCIE Clock [Sync Mode]	
CPU Clock [200MHz]	
Spread Spectrum [Disabled]	
F1:Help ↑↓: Select Item -/+ : Change Value F5: Setup Defaults ESC: Exit →←: Select Menu Enter: Select Sub-menu F10: Save and Exit	

CPU Clock Ratio [19 X]

Sets the CPU clock ratio by keying in a DEC number. Min = 14, Max = 19.

Async CPU/PCIE Clock [Sync Mode]

Sets the Async CPU/PCIE clock. Configuration options: [Sync Mode] [Async Mode].

CPU Clock [200MHz]

Sets the CPU clock by keying in a DEC number. Min = 200, Max = 232.

Spread Spectrum [Disabled]

Sets the spread spectrum. Configuration options: [Disabled] [+/- 0.1%] [+/- 0.2%] [+/- 0.3%]...[+/- 1.0%].

Top Performance [Disabled]

Configuration options: [Disabled] [Enabled]

Primary Display Adapter [PCI-E]

Select which graphics controller to use as the primary boot device.

Configuration options: [PCI] [PCI-E]

VGA Share Memory Size [64M]

Sets the VGA Share Memory Size. Configuration options: [Disabled] [16M] [32M] [64M]

5.4.3 PCIPnP

Phoenix-Award BIOS CMOS Setup Utility		
Advanced		
PCIPnP		Select Menu
Plug & Play O/S	[No]	Item Specific Help▶▶▶
Resources Controlled By	[Auto]	
x IRQ Resources		
Assign IRQ For VGA	[Enabled]	
** PCI Express relative items **		
Maximum Payload Size	[4096]	

Plug & Play O/S [No]

When set to [No], the BIOS configures all the devices in the system. When set to [Yes] and if you install a Plug and Play operating system, the operating system configures the Plug and Play devices not required for boot. Configuration options: [No] [Yes]

Resources Controlled By [Auto]

When set to [Auto], the BIOS automatically configures all the boot and Plug and Play compatible devices. Set to [Manual] if you want to assign the IRQ DMA and memory base address fields. Configuration options: [Auto] [Manual]



The item IRQ Resources becomes user-configurable when you set Resources Controlled By to [Manual].

IRQ Resources

Phoenix-Award BIOS CMOS Setup Utility		
Advanced		
IRQ Resources		Select Menu
IRQ-5 assigned to	[PCI Device]	Item Specific Help▶▶▶
IRQ-7 assigned to	[PCI Device]	Legacy ISA for devices compliant with the original PC AT bus specification, PCI/ISA PnP for devices compliant with the Plug and Play standard whether designed for PCI or ISA bus architecture.
IRQ-9 assigned to	[PCI Device]	
IRQ-10 assigned to	[PCI Device]	
IRQ-11 assigned to	[PCI Device]	
IRQ-14 assigned to	[PCI Device]	
IRQ-15 assigned to	[PCI Device]	

IRQ-xx assigned to

When set to [PCI Device], the specific IRQ is free for use of PCI/PnP devices. When set to [Reserved], the IRQ is reserved for legacy ISA devices. Configuration options: [PCI Device] [Reserved]

Assign IRQ for VGA [Enabled]

Configuration options: [Enabled] [Disabled]

Maximum Payload Size [4096]

Configuration options: [128] [256] [512] [1024] [2048] [4096]

5.4.4 Onboard Device Configuration

Phoenix-Award BIOS CMOS Setup Utility		
Advanced		
Onboard Device Configuration		Select Menu
JMicron RAID controller	[IDE]	Item Specific Help▶▶ Press [Enter] to set
SATA Controller	[Enabled]	
SATA Controller Mode	[IDE]	
Ex-SATA/PCI-E*1 Option	[Ex-SATA]	
HDA Controller	[Auto]	
Onboard LAN	[Enabled]	
Onboard LAN Boot ROM	[Disabled]	
Serial Port1 Address	[3F8/IRQ4]	
Parallel Port Address	[378/IRQ7]	
Parallel Port Mode	[Bi-Directional]	
ECP Mode Use DMA	[3]	
Midi Port Address	[330]	
Midi Port IRQ	[10]	
F1:Help	↑↓: Select Item	-/+ : Change Value
ESC: Exit	→←: Select Menu	F5: Setup Defaults
		Enter: Select Sub-menu F10: Save and Exit

JMicron RAID controller [IDE]

Allows you to disable JMicron RAID controller or sets to IDE/RAID mode.
Configuration options: [Disabled] [IDE] [RAID]

SATA Controller [Enabled]

Enable/Disable Onchip SATA. Configuration options: [Disabled] [Enabled]

SATA Controller Mode [IDE]

Select SATA mode. Configuration options: [IDE] [RAID]

Ex-SATA/PCI-E*1 Option [Ex-SATA]

Allows you to switch Ex-SATA and PCI-E*1 controller.
Configuration options: [Ex-SATA] [PCI-E*1]

HDA Controller [Auto]

Enable/Disable High Definition Audio controller. Configuration options:
[Auto] [Disabled]

Onboard LAN [Enabled]

Enable/Disable onboard LAN. Configuration options: [Enabled] [Disabled]

Onboard LAN Boot ROM [Disabled]

Enable/Disable the bootrom of the onboard LAN. Configuration options:
[Enabled] [Disabled]

Serial Port1 Address [3F8/IRQ4]

Enable/Disable the bootrom of the onboard LAN. Configuration options:
[Enabled] [Disabled]

Parallel Port Address [378/IRQ7]

Select parallel port address. Configuration options: [Disabled] [378/IRQ7] [278/IRQ5] [3BC/IRQ7]

Parallel Port Mode [Bi-Directional]

Select parallel port mode. Configuration options: [Normal] [EPP] [ECP] [Bi-Directional]

ECP Mode Use DMA [3]

Select ECP Mode use DMA. Configuration options: [1] [3]

Midi Port Address [330]

Select Midi port address. Configuration options: [Disabled] [330] [300]

Midi Port IRQ [10]

Select Midi port IRQ. Configuration options: [5] [10]

5.4.5 USB Configuration

The items in this menu allows you to change the USB-related features. Select an item then press <Enter> to display the configuration options.

Phoenix-Award BIOS CMOS Setup Utility	
Advanced	
USB Configuration	Select Menu
USB Controller [Enabled]	Item Specific Help▶ Enable or Disable the USB Controller.
USB2.0 Controller [Enabled]	
USB Legacy support [Enabled]	

USB Controller [Enabled]

Enable or disable USB 1.1 and 2.0 controller. Configuration options: [Disabled] [Enabled]

USB 2.0 Controller [Enabled]

Enables or disables the USB 2.0 controller. Configuration options: [Disabled] [Enabled]

USB Legacy support [Auto]

Enable/Disable USB legacy device (USB keyboard and USB mouse) support. Configuration options: [Auto] [Enabled] [Disabled]

5.5 Power menu

The Power menu items allow you to change the settings for the Advanced Configuration and Power Interface (ACPI) and the Advanced Power Management (APM). Select an item then press <Enter> to display the configuration options.

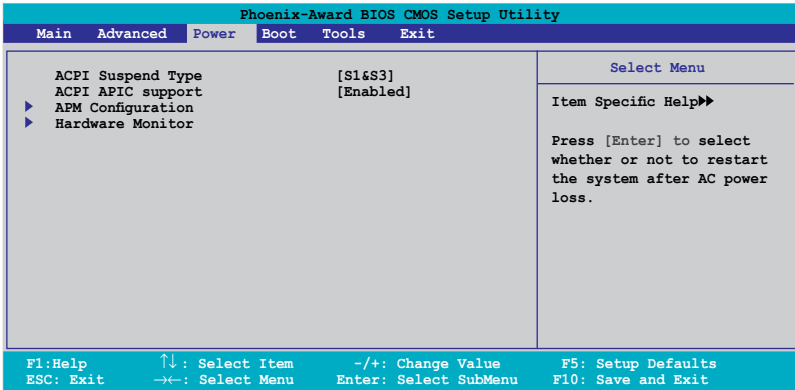

5.5.1 ACPI Suspend Type [S1&S3]

Allows you to select the Advanced Configuration and Power Interface (ACPI) state to be used for system suspend. Configuration options: [S1 (POS)] [S3(STR)] [S1&S3]

5.5.2 ACPI APIC Support [Enabled]

Allows you to enable or disable the Advanced Configuration and Power Interface (ACPI) support in the Application-Specific Integrated Circuit (ASIC). When set to Enabled, the ACPI APIC table pointer is included in the RSDT pointer list. Configuration options: [Disabled] [Enabled]

5.5.3 APM Configuration

Phoenix-Award BIOS CMOS Setup Utility		
Power		
APM Configuration		Select Menu
Power Up By PS/2 Mouse	[Disabled]	Item Specific Help▶▶
Power Up By PS/2 Keyboard	[Disabled]	
Power on By PCI Devices	[Disabled]	
Power on By External Modem	[Disabled]	
Power on By On-board LAN	[Disabled]	
Power On By RTC Alarm	[Disabled]	
x Date (of Month) Alarm	0	
x Time (hh:mm:ss) Alarm	0 : 0 : 0	
Restore on AC Power Loss	[Power Off]	
FWR Button < 4 secs	[Instant-Off]	

F1: Help ↑↓: Select Item -/+ : Change Value F5: Setup Defaults
 ESC: Exit →←: Select Menu Enter: Select SubMenu F10: Save and Exit

Power Up By PS/2 Mouse [Disabled]

Disable or enable Power up by PS/2 Mouse function.
 Configuration options: [Disabled] [Enabled]

Power Up By PS/2 Keyboard [Disabled]

Enable or disable Power up by PS/2 Keyboard function. Configuration options: [Disabled] [Enabled]

Power On By PCI Devices [Disabled]

Enable or disable Power on by PCI Devices function. Configuration options: [Disabled] [Enabled]

Power on By External Modem [Disabled]

Enable or disable Power on By External Modem function. Configuration options: [Disabled] [Enabled]

Power on By On-board LAN [Disabled]

Enable or disable Wake up on LAN function. Configuration options: [Instant-Off] [Suspend]

Power on By RTC Alarm [Disabled]

Enable or disable Power on by RTC Alarm function. When this function is enabled, you can set the date and time of the resume by alarm function. Configuration options: [Instant-Off] [Suspend]

Restore on AC Power Loss [Power Off]

Allows you to select to/not to restart the system after AC power loss.
Configuration options: [Power Off] [Power On] [Last State]

PWR Button < 4 secs [Instant-Off]

When sets to [Instant-Off], the system will go to Soft-off instantly when power-button pressed for less than 4 seconds. When sets to [Suspend], the system will go to Suspend when power button is pressed.
Configuration options: [Suspend] [Instant-Off]

5.5.4 Hardware Monitor

The items in this sub-menu displays the hardware monitor values automatically detected by the BIOS. Select an item then press <Enter> to display the configuration options.

Phoenix-Award BIOS CMOS Setup Utility		
Power		
Hardware Monitor		Select Menu
Q-Fan Controller	[Enabled]	Item Specific Help▶▶ Press [Enter] to enable or disable.
Vcore Voltage	[1.29V]	
3.3V Voltage	[3.33V]	
5V Voltage	[4.96V]	
x 12V Voltage	[11.96V]	
CPU Temperature	54C	
M/B Temperature	40C	
CPU Fan Speed	2136 RPM	
Chassis Fan Speed	0 RPM	
CPU Fan Speed warning	[800 RPM]	

F1: Help ↑ : Select Item -/+ : Change Value F5: Setup Defaults
ESC: Exit →← : Select Menu Enter: Select SubMenu F10: Save and Exit

Q-Fan Controller [Enabled]

Disable or Enable the Q-Fan controller. Configuration options: [Disabled] [Enabled]

Vcore Voltage [Enabled]

Sets the Vcore Voltage. Configuration options: [1.29V] [Ignored]

3.3V Voltage, 5V Voltage, 12V Voltage

The onboard hardware monitor automatically detects the voltage output through the onboard voltage regulators.

CPU Temperature, M/B Temperature

The onboard hardware monitor automatically detects and displays the motherboard and CPU temperatures. These items are not user-configurable.

CPU/Chassis Fan Speed

The onboard hardware monitor automatically detects and displays the CPU and chassis fan speeds in rotations per minute (RPM). These items are not user-configurable.

CPU Fan Speed warning [800 RPM]

Allows you to disable or set the CPU fan warning speed.
Configuration options: [Disabled] [800 RPM] [1200 RPM] [1600 RPM]

5.6 Boot menu

The Boot menu items allow you to change the system boot options. Select an item then press <Enter> to display the sub-menu.

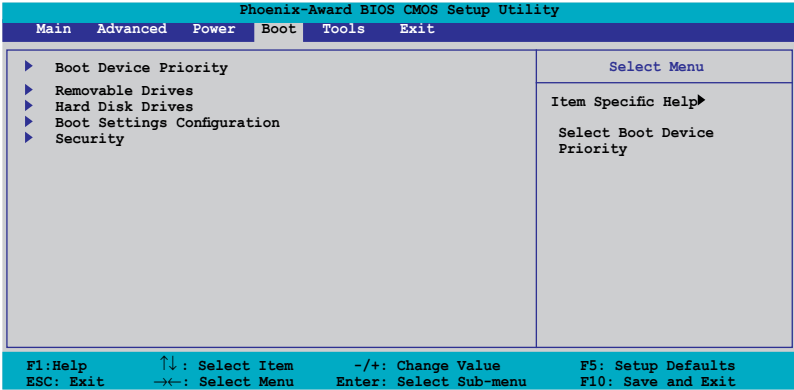

5.6.1 Boot Device Priority

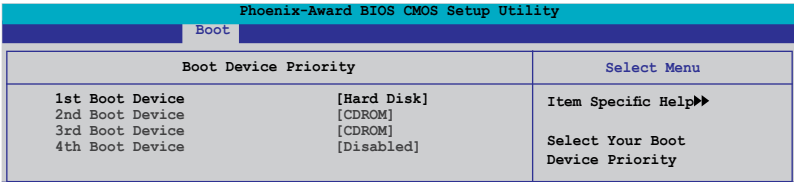

1st ~ 4th Boot Device

These items specify the boot device priority sequence from the available devices. The number of device items that appears on the screen depends on the number of devices installed in the system. Configuration options: [Removable] [Hard Disk] [CDROM] [Legacy LAN] [Disabled]

Removable Drives

This item lists the detected removable drives and allows you to select removable boot device priority. Select a device from the list and use <+> and <-> to move it up /down in the list.

Hard Disk Drives

Allows you to assign hard disk drives attached to the system.

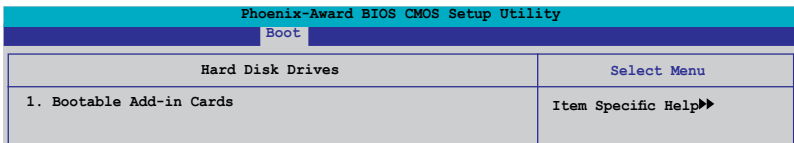

5.6.2 Boot Settings Configuration

Phoenix-Award BIOS CMOS Setup Utility		
Boot		
Boot Settings Configuration	Select Menu	
Case Open Warning	[Enabled]	Item Specific Help▶▶
Quick Boot	[Enabled]	
Boot Up Floppy Seek	[Disabled]	
Bootup Mun-Lock	[On]	Press [Enter] to enable or disable.
Typematic Rate Setting	[Disabled]	
x Typematic Rate (Chars/Sec)	6	
x Typematic Delay (Msec)	250	
OS Select For DRAM > 64MB	[Non-OS2]	
Full Screen LOGO	[Enabled]	
Halt On	[All, But Keyboard]	

F1: Help ↑↓: Select Item -/+ : Change Value F5: Setup Defaults
ESC: Exit →←: Select Menu Enter: Select Sub-menu F10: Save and Exit

Case Open Warning [Enabled]

Allows you to enable or disable the Case Open Warning feature.
Configuration options: [Disabled] [Enabled]

Quick Boot [Enabled]

Allows the system to skip certain tests while booting. This will decrease the time needed to boot the system. Configuration options: [Disabled] [Enabled]

Boot Up Floppy Seek [Disabled]

Allows the system to test floppy drives to determine whether they have 40 or 80 tracks. Configuration options: [Disabled] [Enabled]

Boot Up Num-Lock [On]

Selects power on state for NumLock. Configuration options: [Off] [On]

Typematic Rate Setting [Disabled]

Keystrokes repeat at a rate determined by the keyboard controller - when enabled, the typematic rate and typematic delay can be selected. Configuration options: [Disabled] [Enabled]

OS Select for DRAM > 64MB [Non-OS2]

Set this item to OS2 only when you are running on an OS/2 operating system with an installed RAM of greater than 64 KB. Configuration options: [Non-OS2] [OS2]

Full Screen LOGO [Enabled]

Allows you to enable or disable the full screen logo display feature. Configuration options: [Disabled] [Enabled]

Halt On [All, But Keyboard]

Allows you to error report type.

Configuration options: [All Errors] [No Errors] [All, But Keyboard] [All, But Diskette] [All, But Disk/Key]

5.6.3 Security

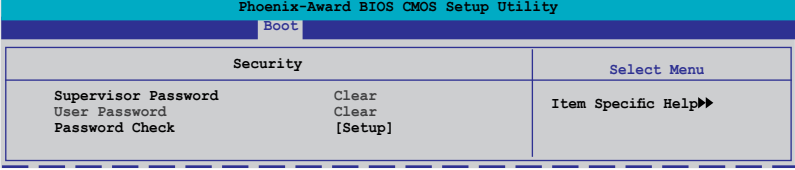

Phoenix-Award BIOS CMOS Setup Utility		
Boot		
Security		Select Menu
Supervisor Password	Clear	Item Specific Help▶▶
User Password	Clear	
Password Check	[Setup]	

Supervisor Password

User Password

These fields allow you to set passwords:

To set a password:

1. Select an item then press <Enter>.
2. Type in a password using a combination of a maximum of eight (8) alpha-numeric characters, then press <Enter>.
3. When prompted, confirm the password by typing the exact characters again, then press <Enter>. The password field setting is changed to Set.

To clear the password:

1. Select the password field and press <Enter> twice. The following message appears:



```
PASSWORD DISABLED !!!  
Press any key to continue...
```

2. Press any key to continue. The password field setting is changed to Clear.

A note about passwords

The Supervisor password is required to enter the BIOS Setup program preventing unauthorized access. The User password is required to boot the system preventing unauthorized use.

Forgot your password?

If you forget your password, you can clear it by erasing the CMOS Real Time Clock (RTC) RAM. The RAM data containing the password information is powered by the onboard button cell battery. If you need to erase the CMOS RAM, refer to section “2.6 Jumper” for instructions.

Password Check

This field requires you to enter the password before entering the BIOS setup or the system. Select [Setup] to require the password before entering the BIOS Setup. Select [System] to require the password before entering the system. Configuration options: [Setup] [System]

5.7 Exit menu

The Exit menu items allow you to load the optimal or failsafe default values for the BIOS items, and save or discard your changes to the BIOS items.

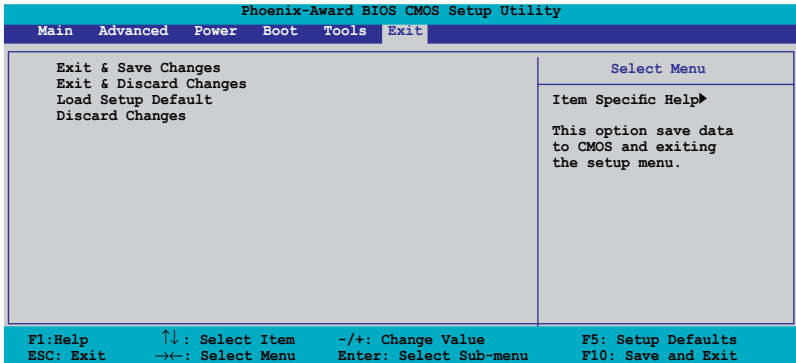



Pressing <Esc> does not immediately exit this menu. Select one of the options from this menu or <F10> from the legend bar to exit.

Exit & Save Changes

Once you are finished making your selections, choose this option from the Exit menu to ensure the values you selected are saved to the CMOS RAM. An onboard backup battery sustains the CMOS RAM so it stays on even when the PC is turned off. When you select this option, a confirmation window appears. Select YES to save changes and exit.



If you attempt to exit the Setup program without saving your changes, the program prompts you with a message asking if you want to save your changes before exiting. Press <Enter> to save the changes while exiting.

Exit & Discard Changes

Select this option only if you do not want to save the changes that you made to the Setup program. If you made changes to fields other than System Date, System Time, and Password, the BIOS asks for a confirmation before exiting.

ASUS EZ Flash 2

Press Enter to run ASUS EZ Flash 2 utility.

Load Setup Defaults

This option allows you to load the default values for each of the parameters on the Setup menus. When you select this option or if you press <F5>, a confirmation window appears. Select YES to load default values. Select Exit & Save Changes or make other changes before saving the values to the non-volatile RAM.

Discard Changes

This option allows you to discard the selections you made and restore the previously saved values. After selecting this option, a confirmation appears. Select YES to discard any changes and load the previously saved values.

Free Manuals Download Website

<http://myh66.com>

<http://usermanuals.us>

<http://www.somanuals.com>

<http://www.4manuals.cc>

<http://www.manual-lib.com>

<http://www.404manual.com>

<http://www.luxmanual.com>

<http://aubethermostatmanual.com>

Golf course search by state

<http://golfingnear.com>

Email search by domain

<http://emailbydomain.com>

Auto manuals search

<http://auto.somanuals.com>

TV manuals search

<http://tv.somanuals.com>