

AXIS 215 PTZ/ AXIS 215 PTZ-E

Network Camera

User's Manual

About This Document

This manual is intended for administrators and users of the AXIS 215 PTZ/AXIS 215 PTZ-E Network Camera, and is applicable for software release 4.40. Previous experience of networking will be of use when installing and using this product. Some knowledge of UNIX or Linux-based systems would also be beneficial, for developing shell scripts and applications. Later versions of this document will be posted to the Axis Website, as required.

Safety Notices Used In This Manual

Caution! - Indicates a potential hazard that can damage the product.
Important! - Indicates a hazard that can seriously impair operation.
 Do not proceed beyond any of the above notices until you have fully understood the implications.

Intellectual Property Rights

Axis AB has intellectual property rights relating to technology embodied in the product described in this document. In particular, and without limitation, these intellectual property rights may include one or more of the patents listed at <http://www.axis.com/patent.htm> and one or more additional patents or pending patent applications in the US and other countries. This product contains licensed third-party software. See the menu item "About" in the product's user interface for more information. This product contains source code copyright Apple Computer, Inc., under the terms of Apple Public Source License 2.0 (see <http://www.opensource.apple.com/apsl/>). The source code is available from: <http://developer.apple.com/darwin/projects/bonjour/>

Legal Considerations

Camera surveillance can be prohibited by laws that vary from country to country. Check the laws in your local region before using this product for surveillance purposes.

Electromagnetic Compatibility (EMC)

Note:
 To comply with limits in Class B, use one of the following accessories when connecting I/O cables:

20291 ACC FERRITE SPLIT SNAP IN EUR
 20292 ACC FERRITE SPLIT SNAP IN US

USA – This equipment generates, uses, and can radiate radio frequency energy and if not installed and used in accordance with the instruction manual, may cause interference to radio communications. It has been tested and found to comply with the limits for a Class B computing device pursuant to Subpart B of Part 15 of FCC rules, which are designed to provide reasonable protection against such interference when operated in a commercial environment. Operation of this equipment in a residential area is likely to cause interference, in which case the user at his/her own expense will be required to take whatever measures may be required to correct the interference. Shielded cables should be used with this unit to ensure compliance with the Class B limits.

Canada – This Class B digital apparatus complies with Canadian ICES-003.

Europe – This digital equipment fulfills the requirements for radiated emission according to limit B of EN55022:1998, and the requirements for immunity according to EN55024:1998 residential, commercial, and light industry.



Japan – This is a class B product based on the standard of the Voluntary Control Council for Interference from Information Technology Equipment (VCCI). If this is used near a radio or television receiver in a domestic environment, it may cause radio interference. Install and use the equipment according to the instruction manual.

Australia – This electronic device meets the requirements of the Radio communications (Electromagnetic Compatibility) Standard 1998 AS/NZS 3548.

Liability

Every care has been taken in the preparation of this manual; Please inform your local Axis office of any inaccuracies or omissions. Axis Communications AB cannot be held responsible for any technical or typographical errors and reserves the right to make changes to the product and manuals without prior notice. Axis Communications AB makes no warranty of any kind with regard to the material contained within this document, including, but not limited to, the implied warranties of merchantability and fitness for a particular purpose. Axis Communications AB shall not be liable nor responsible for incidental or consequential damages in connection with the furnishing, performance or use of this material.

Trademark Acknowledgments

Ethernet, Internet Explorer, Linux, Macintosh, Microsoft, Mozilla, Netscape Navigator, UNIX, Windows, WWW are registered trademarks of the respective holders. Java and all Java-based trademarks and logos are trademarks or registered trademarks of Sun Microsystems, Inc. in the United States and other countries. UPnP is a certification mark of the UPnP™ Implementers Corporation. Axis Communications AB is independent of Sun Microsystems Inc.

Axis Customer Services

Should you require any technical assistance, please contact your Axis reseller. If your questions cannot be answered immediately, your reseller will forward your queries through the appropriate channels to ensure a rapid response. If you are connected to the Internet, you can:

- download user documentation and firmware updates
- find answers to resolved problems in the FAQ database. Search by product, category, or phrases
- report problems to Axis support staff by logging in to your private support area
- visit the Axis Support Web at www.axis.com/techsup/

Safety Notice – Battery Replacement

The AXIS 215 PTZ/ AXIS 215 PTZ-E uses a 3.0V CR2032 Lithium battery as the power supply for its internal real-time clock (RTC). This battery will, under normal conditions, last for a minimum of 5 years. Low battery power affects the operation of the RTC, causing it to reset at every power-up. A log message will appear when battery replacement is required. The battery should not be replaced unless required! If the battery does need replacing, please observe the following points:

Caution! Danger of Explosion if battery is incorrectly replaced.
 Replace only with the same or equivalent battery, as recommended by the manufacturer.

Dispose of used batteries according to the manufacturer's instructions.

RoHS

This product complies with both the European RoHS directive, 2002/95/EC, and the Chinese RoHS regulations, ACPEIP.



WEEE Directive

The European Union has enacted a Directive 2002/96/EC on Waste Electrical and Electronic Equipment (WEEE Directive). This directive is applicable in the European Union member states. The WEEE marking on this product (see right) or its documentation indicates that the product must not be disposed of together with household waste. To prevent possible harm to human health and/or the environment, the product must be disposed of in an approved and environmentally safe recycling process. For further information on how to dispose of this product correctly, contact the product supplier, or the local authority responsible for waste disposal in your area. Business users should contact the product supplier for information on how to dispose of this product correctly. This product should not be mixed with other commercial waste.



AXIS 215 PTZ User's Manual
 December 2008

Part No: 34088
 Revision: 2.00

Copyright© Axis Communications AB, 2007-2008

Accessing the camera	4
Accessing from a browser	4
Setting the Password	4
Accessing the camera from the Internet	4
The Live View page	5
Video and Audio Streams	8
Video Stream Types	8
MPEG-4 protocols and communication methods	9
AXIS Media Control	9
How to stream MPEG-4	9
Other methods of accessing the video stream	10
Setup	11
Accessing the setup tools from a browser	11
Custom Settings	18
User Defined Links	19
PTZ Configuration	21
Event Configuration	23
Event Servers	23
Event Types	24
Motion Detection	25
Port Status (AXIS 215 PTZ only)	26
System Options	27
Security	27
Date & Time	29
Network	29
Network - SOCKS	31
Network - QoS (Quality of Service)	31
Network - SMTP (email)	31
Network - SNMP	32
Network - UPnP	32
Network - RTP/MPEG-4	32
Network - Bonjour	32
Ports & Devices - I/O Ports (for AXIS 215 PTZ only)	32
Maintenance	33
Support	34
Advanced	34
Resetting to Factory Default Settings	34
Unit Connectors	35
I/O terminal connector (for AXIS 215 PTZ only)	35
Connection diagram	36
LED indicators	36
Power connection	36
Troubleshooting	37
Checking the Firmware	37
Updating the Firmware	37
Customer Services	38
Technical Specifications	41
File sizes	44
General performance considerations	44
Optimizing your system	44
Frame rates - Motion JPEG	45
Frame rates - MPEG-4	45
Bandwidth	45
Glossary of Terms	47
Index	52

Accessing the camera

The AXIS 215 PTZ/AXIS 215 PTZ-E can be used with most standard operating systems and supports Microsoft Internet Explorer 6.x or later, Netscape 7.x or later and Mozilla 1.4 or later.

The AXIS 215 PTZ-E Network Camera does not support audio and does not have I/O ports. All references in this manual to audio and to the I/O parts pertain to the AXIS 215 PTZ Network Camera only.

Note: To view streaming video in Microsoft Internet Explorer for Windows, you must set your browser to allow the AXIS Media Control (AMC) to be installed on your computer. The first time an MPEG-4 video stream is accessed, AMC also installs an MPEG-4 decoder for viewing the video stream. As a license is required for each instance of the decoder, the product administrator may have disabled the installation. If your workstation restricts the use of additional software components, the camera can be configured to use a Java applet for updating JPEG images. See the online help for more information.

Accessing from a browser

1. Start a browser (Internet Explorer, Mozilla, Netscape Navigator).
2. Enter the IP address or host name of the AXIS 215 PTZ/AXIS 215 PTZ-E in the Location/ Address field of your browser.
3. Enter the user name and password set by the administrator.
4. A video image is displayed in your browser.



Note:

User functions in the AXIS 215 PTZ/AXIS 215 PTZ-E may have been customized to meet the specific requirements of the application. Consequently, many of the examples and functions in this section may differ from those displayed in your Live View page.

Setting the Password

1. When accessing the camera for the first time, the 'Configure Root Password' dialog will be displayed on the screen.
2. Enter a password and then re-enter it, to confirm the spelling. Click OK.

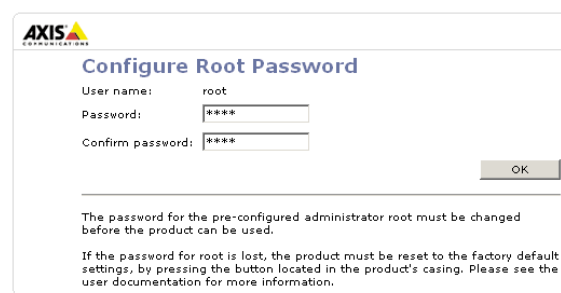

3. Enter the User name: root
Note: The default administrator user name root is permanent and cannot be deleted or altered.
4. Enter the password as set in step 2 above, and click OK. If the password is lost, the camera must be reset to the factory default settings. See page 34.
5. If required, click Yes to install the AXIS Media Control (AMC). You will need administrator rights on the computer to do this.

Accessing the camera from the Internet

Once installed, the camera is accessible on your local network (LAN). To access the camera from the Internet you must configure your router/firewall to allow incoming data traffic. For security reasons this is usually done on a specific port. Please refer to the documentation for your router/firewall for further instructions.

For more information, please visit the AXIS Internet Dynamic DNS Service at www.axiscam.net or, for Technical notes on this and other topics, visit the Axis Support Web at www.axis.com/techsup

The Live View page

The following provides an overview of each button on the Live View page. If the AXIS 215 PTZ/AXIS 215 PTZ-E has been customized, the buttons will be displayed accordingly:

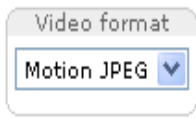

The Video Format drop-down list allows the video format on the Live View page to be temporarily changed.

The two types of **Output button** (AXIS 215 PTZ only) each control the output directly from the Live View page. These are configured under **Setup > Live View Config > Layout**.



Pulse - click this button to activate the output for a defined period of time, e.g. to switch on a light for 20 seconds.



Active/Inactive - click these buttons to manually start and stop a connected device, e.g. switch a light on/off.



These buttons start/stop the **Sequence Mode** which automatically displays the view from preset positions at set intervals. Sequence mode is configured in **Setup > PTZ Configuration > Sequence Mode**.



The source list is used to select the preset positions already configured in the camera. These are created in **Setup > PTZ Configuration > Preset Positions**.



The **Manual trigger buttons** trigger an action directly from the Live View page. These buttons are configured under **Setup > Live View Config > Layout**. Click these buttons to manually start and stop events.

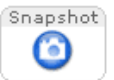

Use the **Snapshot** button to capture a snapshot of the image currently being displayed in the window. Right-click on the image to save it in JPEG format on your computer.

Area Zoom

This allows you to draw a box over a desired area to zoom into. In order to fine-tune the precision, Area zoom should be calibrated from **Setup > PTZ Configuration > Advanced > Calibration**.

To activate Area Zoom on the Live View page, click the Center mode button in the AMC viewer toolbar (in other Internet browsers choose PTZ > Center). Click in the image and while holding down the left mouse button, draw a square over the area you would like to zoom into.

Pan/Tilt/Zoom controls

The Live View page also displays the **Pan/Tilt/Zoom** controls. These are enabled/disabled for specified users by the administrator under **System Options > Security > Users > User List**.

See also *Advanced - Limits, on page 21* for information on **E-flip, proportional speed and Auto-flip** (PTZ Configuration > Advanced > Limits.)

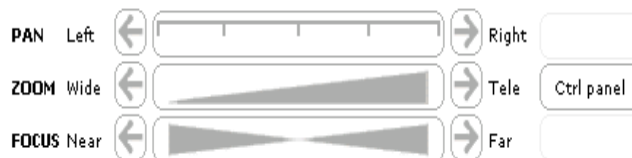

The control panel

Click the Ctrl panel button to display the control panel, where the following settings are available:



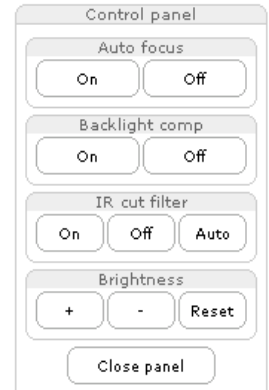





- **Auto focus** - automatically adjusts the image focus.
- **Backlight comp** - enabling backlight compensation makes the subject clearer if the image background is too bright, or if the subject is too dark.
- **IR cut filter** - when set to off, the camera will be able to “see” infrared light, e.g. at night, thus making the image clearer. The image is shown in black & white when the IR cut filter is off.
- **Brightness** - the image brightness can be adjusted using the +/- buttons, where a higher value produces a brighter image. Click the Reset button to revert to the values saved under **Video & Image > Advanced > Camera**.
- **Shortcuts** - these buttons can be configured to provide direct access to various built-in auxiliary commands provided by the PTZ driver. See **Advanced - Ctrl Panel** on page 22.



Viewer controls

The default viewer to use for displaying moving images is selected from Setup > Live View Config > Layout.

The AMC viewer toolbar is available in Microsoft Internet Explorer for Windows only. See *AXIS Media Control, on page 9* for more information. The AMC viewer toolbar displays the following buttons:

-  The **Play/Stop** buttons start and stop the live video stream.
-  The **Snapshot** button takes a snapshot of the currently displayed image. The Snapshot function and the target directory for saving snapshots can be configured from AMC (AXIS Media Control), which is available from the Windows Control Panel (Internet Explorer for Windows only).
-  Click the **Start recording** button to make an MPEG-4 recording. Click again to stop the recording. The recording is saved in the folder specified in the Recording tab in the AMC Control Applet. Only available if the recording button is enabled on the Live View Config page
-  Click the **View Full Screen** button and the video image will fill the entire screen area. No other windows will be visible. Press Esc (Escape) on the computer keyboard to cancel full screen view.
-  Click the **Mute /Microphone** buttons to switch the sound off and on. Only available if Audio is enabled. (AXIS 215 PTZ-E does not support audio.)
-  Use the sliders to control the volume on the speaker and microphone. The volume can be set between 0 and 100. (AXIS 215 PTZ-E does not support audio.)
- Navigation mode:
 -  **Center** will move the camera view to center on the position that was clicked. Also used for Area zoom.
 -  **Joystick** moves the camera in the direction indicated by a mouse click, relative to the center of the image. The further from the center the image is clicked, the higher the movement speed.

Server push (not available for Microsoft Internet Explorer)

With this method, the AXIS 215 PTZ/AXIS 215 PTZ-E maintains and controls an open HTTP connection to the browser and sends data as and when required, for as long as required.

QuickTime

For use with MPEG-4 only. Note that in the settings for Video & Image > Advanced > MPEG-4, the Video object type must be set to *Simple*.

Java applet

This alternative uses a Java applet to update the images in the browser. No download is required. Note that when this alternative is selected, external video sources will not be available on the live view page, and audio will be mono-directional only (to the client only). (AXIS 215 PTZ-E does not support audio and does not have I/O ports.)

Still Image

Displays still images only. Hit your browser's Refresh button to view a new image.

PTZ Control Queue

Only one user can use the Pan/Tilt/Zoom controls at any one time. When multiple users are accessing the AXIS 215 PTZ/AXIS 215 PTZ-E's Live View page, they can be placed in the PTZ control queue and assigned a set period of time during which they have the use of the PTZ controls. Use the buttons to request or release control of the PTZ controls.

PTZ Control Queue	
Status in queue:	<input type="text" value="Not in queue"/>
Position in queue:	<input type="text"/>
Time remaining:	<input type="text"/> seconds
<input type="button" value="Request control"/>	

The PTZ Control Queue is set up by the administrator under PTZ Configuration > Control Queue.

Video and Audio Streams

The AXIS 215 PTZ/AXIS 215 PTZ-E provides several different image and video formats. The type to use depends on your requirements and on the properties of your network.

The Live View page in the AXIS 215 PTZ/AXIS 215 PTZ-E provides access to Motion JPEG and MPEG-4 video streams, as well as to single JPEG images. Other applications and clients can also access these video and audio streams/images directly, without going via the Live View page.

Note: AXIS 215 PTZ-E Network Camera does not support audio.

Video Stream Types

Motion JPEG

This format uses standard JPEG still images in the video stream. These images are then displayed and updated at a rate sufficient to create a stream that shows constantly updated motion.

The Motion JPEG stream uses considerable amounts of bandwidth, but also provides excellent image quality and access to each and every individual image contained in the stream.

Note also that multiple clients accessing Motion JPEG streams can use different image settings.

MPEG-4

This is a video compression standard that makes good use of bandwidth, providing high-quality video streams at less than 1 Mbit/s.

The MPEG-4 standard provides scope for a large range of different coding tools for use by various applications in different situations, and the AXIS 215 PTZ/AXIS 215 PTZ-E provides certain subsets of these tools. These are represented as **Video object types**, which are selected for use with different viewing clients. The supported video object types are:

- **Simple** - sets the coding type to H.263, as used by e.g. QuickTime™.
- **Advanced Simple** - sets the coding type to MPEG-4 Part 2, as used by AMC (AXIS Media Control)

When using MPEG-4 it is also possible to control the bit rate, which in turn allows the amount of bandwidth usage to be controlled. CBR (constant bit rate) is used to achieve a specific bit rate by varying the quality of the MPEG-4 stream. When using VBR (variable bit rate), the quality of the video stream is kept as constant as possible, at the cost of a varying bit rate.

- Notes:**
- MPEG-4 is licensed technology. The AXIS 215 PTZ/AXIS 215 PTZ-E includes one viewing client license. Installing additional unlicensed copies of the viewing client is prohibited. To purchase additional licenses, contact your Axis reseller.
 - All clients viewing the MPEG-4 stream must use the same image settings.

MPEG-4 protocols and communication methods

To deliver live streaming video over IP networks, various combinations of transport protocols and broadcast methods are employed.

- RTP (Realtime Transport Protocol) is a protocol that allows programs to manage the real-time transmission of multimedia data, via unicast or multicast.
- RTSP (Real Time Streaming Protocol) serves as a control protocol, to negotiate which transport protocol to use for the stream. RTSP is thus used by a viewing client to start a unicast session, see below.
- UDP (User Datagram Protocol) is a communications protocol that offers limited service for exchanging data in a network that uses the Internet Protocol (IP). UDP is an alternative to the Transmission Control Protocol (TCP). The advantage of UDP is that it is not required to deliver all data and may drop network packets when there is e.g. network congestion. This is suitable for live video, as there is no point in re-transmitting old information that will not be displayed anyway.
- Unicasting is communication between a single sender and a single receiver over a network. This means that the video stream goes independently to each user, and each user gets their own stream. A benefit of unicasting is that if one stream fails, it only affects one user.
- Multicast is bandwidth-conserving technology that reduces bandwidth usage by simultaneously delivering a single stream of information to multiple network users. This technology is used primarily on delimited networks (intranets), as each user needs an uninterrupted data flow and should not rely on network routers.

AXIS Media Control

For accessing live video (MPEG-4 and/or Motion JPEG) and audio from AXIS 215 PTZ/AXIS 215 PTZ-E, the AXIS Media Control (AMC) in Microsoft Internet Explorer for Windows is recommended. This ActiveX component is automatically installed on first use, after which it can be configured by opening the AMC Control Panel applet from the Windows Control Panel. Alternatively, right-click the video image in Internet Explorer.

See AXIS Media Control User's Manual, available from the support pages on the Axis web site at: www.axis.com

Note: AXIS 215 PTZ-E does not support audio and does not have I/O ports.

How to stream MPEG-4

Deciding on the combination of protocols and methods to use depends on your viewing requirements, and on the properties of your network. Setting the preferred method(s) is done in the control applet for AMC, which is found in the Windows Control Panel. When this has been set, AMC will test all the selected methods in the specified order, until the first functioning one is found.

RTP+RTSP

This method (actually RTP over UDP and RTSP over TCP) should be your first consideration for live video, especially when it is important to always have an up-to-date video stream, even if some images do get dropped. This can be configured as multicast or unicast.

Multicasting provides the most efficient usage of bandwidth, especially when there are large numbers of clients viewing simultaneously. Note however, that a multicast broadcast cannot pass a network router unless the router is configured to allow this. It is thus not possible to multicast over e.g. the Internet.

Unicasting should be used for video-on-demand broadcasting, so that there is no video traffic on the network until a client connects and requests the stream. However, as more and more unicast clients connect, the traffic on the network will increase and may cause congestion. Although there is a maximum of 20 unicast viewers, note that all multicast users combined count as 1 unicast viewer.

RTP/RTSP

This unicast method is RTP tunneled over RTSP. This can be used to exploit the fact that it is relatively simple to configure firewalls to allow RTSP traffic.

RTP/RTSP/HTTP

This method can also be used to traverse firewalls. Firewalls are commonly configured to allow the HTTP protocol, thus allowing RTP to be tunneled.

Other methods of accessing the video stream

Video/images from the AXIS 215 PTZ/AXIS 215 PTZ-E can also be accessed in the following ways:

- If supported by the client, the AXIS 215 PTZ/AXIS 215 PTZ-E can use Motion JPEG server push to display video. This option maintains an open HTTP connection to the browser and sends data as and when required, for as long as required.
- As single JPEG images in a browser. Enter e.g. the path: `http://<IP address>/axis-cgi/jpg/image.cgi?resolution=CIF`
- Windows Media Player. This requires AMC and the MPEG-4 decoder to be installed. The paths that can be used are listed below, in the order of preference.
 - Unicast via RTP: `axrtpu://<IP address>/mpeg4/media.amp`
 - Unicast via RTSP: `axrtsp://<IP address>/mpeg4/media.amp`
 - Unicast via RTSP, tunneled via HTTP: `axrtsphhttp://<IP address>/mpeg4/media.amp`
 - Multicast: `axrtmp://<IP address>/mpeg4/media.amp`

Other MPEG-4 clients

Although it may be possible to use other clients to view the MPEG-4 stream, this is not guaranteed by Axis.

For some other clients, e.g. QuickTime™ the Video Object Type must be set to *Simple*. It may also be necessary to adjust the advanced MPEG-4 settings.

To access the video stream from e.g. QuickTime™ the following path can be used:

`rtsp://<IP address>/mpeg4/media.amp`

This path is for all supported methods, and the client will negotiate with the AXIS 215 PTZ/AXIS 215 PTZ-E to determine exactly which transport protocol to use.

Audio transmission methods (AXIS 215 PTZ only)

The audio stream can be accessed in the Live View page when viewing either Motion JPEG or MPEG.

Using Motion JPEG

The basic transmission method of audio used in conjunction with Motion JPEG video streaming is transmission over HTTP. The video and audio streams are not synchronized when using Motion JPEG so the streams may be slightly out of sync. The latency in any stream should be low, but this will depend on the network infrastructure.

Using MPEG-4

When using MPEG-4, audio is streamed using the same protocol as the video stream.

When audio is transmitted using MPEG-4, the Axis product sends synchronization information along with the streams to the client that is performing the synchronization.

Audio is streamed from the client to the server over HTTP when using Motion JPEG and MPEG-4.

Accessing the Audio Streams (AXIS 215 PTZ only)

In addition to accessing audio in the Live View page using AMC, audio from the Video Server can also be accessed in the following ways:

The VAPIX® API

You can read about accessing audio for the other protocols through VAPIX, Axis Communications' powerful API, at <http://www.axis.com/techsup>

QuickTime/Windows Media Player

It is possible to use QuickTime and Windows Media Player to listen to the audio stream using the same methods to access video streams.

Setup

The AXIS 215 PTZ/AXIS 215 PTZ-E is configured from the setup tools, which are available from the link in the web interface. The setup tools can be used by:

- **administrators**, who have unrestricted access to all the Setup tools
- **operators**, who have access to the Video & Image, Live View Config and Event Configuration settings.

See the section on *Security*, on page 27 for more information on user access control.

Accessing the setup tools from a browser

Follow the instructions below:

1. Start the browser and enter the IP address or host name of the AXIS 215 PTZ/AXIS 215 PTZ-E in the location/address field.
2. The Live View page is now displayed. Click **Setup** to display the Setup configuration tools.

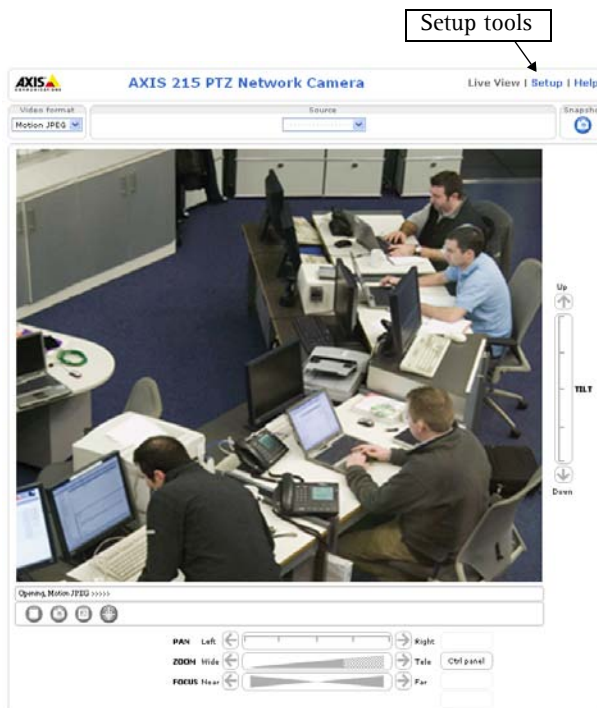

Video & Image settings

The following descriptions offer examples of the available features in the AXIS 215 PTZ/AXIS 215 PTZ-E. For details of each setting, please refer to the online help files [?](#).

To optimize the video images to your requirements, modify the following settings under **Image Appearance**:

- Resolution (including Aspect ratio correction and 4CIF de-interlacing)
- Compression
- Rotate image
- White balance
- Color setting

Notes: All configuration of images and overlays will affect the performance of the AXIS 215 PTZ/AXIS 215 PTZ-E, depending on the usage and the available bandwidth. Please keep in mind the following when changing the image settings:

- Lower compression improves image quality, but generates larger files
- Color uses more bandwidth than Black & White
- Rotating the image will lower the maximum frame rate
- When using MPEG-4 as the video format, the compression setting will define the minimum compression level. The compression level will temporarily increase as and when required, i.e. when the bit rate approaches the maximum value as defined in the current profile@level combination.
- In certain conditions, the white balancing system will not operate effectively. See *Video Image Problems*, on page 40 for more information.

You may need to click the **Stop** and **Play** buttons on the Live View page before the settings take effect.

Overlay Settings

Use these settings to include an image as an overlay, and/or the date and time, along with text of your own.

See **Overlay Image Settings** below for instructions on how to upload an overlay image to the AXIS 215 PTZ/AXIS 215 PTZ-E.

Text overlays are included on one line at the top or bottom of the video image. Use text overlays in combination with OSDI (On-Screen Directional Indicator) on page 31 to aid the viewer in navigating the camera.

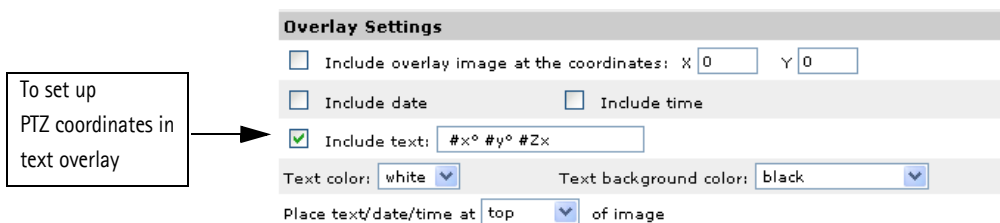
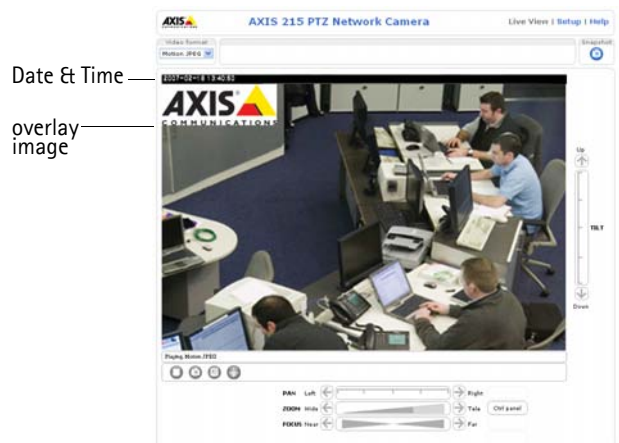

Use #P #L to show the Preset and OSDI Zone name as text overlay

Video Stream

The video stream time can be set as *Unlimited*, or a **maximum stream time** per session in seconds, minutes or hours can be defined. When the set time has expired, a new stream can be started by refreshing the page in the Web browser. Note that the maximum video stream time does not apply to clients connecting via multicast.

To avoid bandwidth problems on the network, the **frame rate** allowed to each viewer can also be limited. Select either *Unlimited* or define a **maximum frame rate** per viewer.

For a preview of the image and overlay settings before saving, click **Test**. When you are satisfied with the settings, click **Save**.

Please use the online help files [?](#) for more information.

Overlay Image Settings

An overlay image is an image included in the video image. This might, for example, be your own company logo. Follow these instructions to upload and use an overlay image:

1. Go to **Setup > Video & Image > Overlay Image**.
2. To upload the image to the AXIS 215 PTZ/AXIS 215 PTZ-E, click the **Browse** button and locate it on your computer or server.
3. Click the **Upload** button and follow the on-screen instructions.
4. The image is now available in the **Use overlay image** drop-down list.
5. Click **Save**.
6. Go to **Setup > Video & Image** and modify the parameters under **Overlay Settings**.

Overlay image requirements:

Image Formats	Image Size
<ul style="list-style-type: none"> • Windows 24-bit BMP (full color) • Windows 4-bit BMP (16 colors) 	The height and width of the overlay image in pixels must be exactly divisible by 4.

There are a number of limitations when using overlay images, such as the size and positioning of images. Please use the online help [?](#) for more information.

Advanced settings

Camera - to optimize the lighting settings according to your requirements, modify the following settings under **Lighting Conditions**:

- **Brightness** - increase the value to brighten the image.
- **Sharpness** - increase the value to sharpen the image. A higher value will sharpen the image but also increase the image noise, especially in low lighting.
- **IR cut filter** - set the IR cut filter to **On**, **Off** or **Auto**. The IR cut filter can also be set to **On**, **Off** or **Auto** directly from the control panel on the Live View page.
- **Backlight compensation** - this setting is used to make the subject appear clearer against e.g. a bright background.

Low Light Behavior

These settings determine how the camera will function in low light conditions. Adjustments made here affect image quality and are basically a measure of how much noise to allow in images. Please use the online help [?](#) for more information on each individual setting.

- **Priority**
- **Exposure control**
- **Max exposure time**
- **Max gain**

Image Settings

- **Auto focus enabled** (default setting)- Auto focus can also be set to **On/Off** directly from the control panel on the Live View page.

- **Image freeze on PTZ** - freeze the image either during pan, tilt, zoom movement or between preset positions only. Once the camera has reached its position, the current image is shown.

MPEG-4 Settings

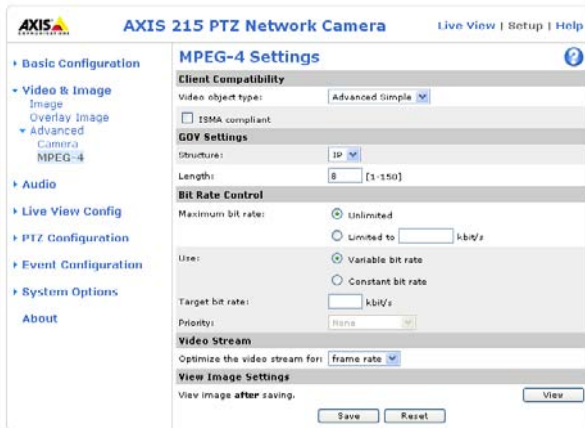

The AXIS 215 PTZ/AXIS 215 PTZ-E supports the following different MPEG-4 profiles and levels:

Profile@Level	Properties
Advanced Simple Profile @ Level 3b	Max bit rate = 1,5 Mbps ISMA compliant
Advanced Simple Profile @ Level 5	Max Bit rate = 8 Mbit/s

Level 5 is preferred if there is enough bandwidth available, as the image quality of the video stream will be better than if level 3 is used. The viewing client must support the profile used for the video stream otherwise the MPEG-4 stream can not be viewed.

Note: AXIS Media Control supports all the configuration possibilities available on this page.

The **GOV structure** can be set to either I or IP, which describes the type of images included in the video stream, as well as their internal order. The IP-structure generally sends the differences compared to the previous image and far fewer complete images, so this method uses much less bandwidth than the I-structure. The I-structure gives higher frame rates when using a high resolution, but requires more bandwidth.

The **GOV length** determines the sum total of P-images and I-images in a GOV. Setting the GOV length to a high value saves considerably on bandwidth. However there may be noticeable decay in the image at high values.

Note: GOV = Group of VOPs
VOP = Video Object Plane
Video Object Plane = image

Bit Rate Control

Limiting the maximum bit rate is a good way of controlling the bandwidth used by the MPEG-4 video stream. Leaving the Maximum bit rate as unlimited will provide consistently good image quality, but at the expense of increased bandwidth usage whenever there is more activity in the image. Limiting the bit rate to a defined value will prevent excessive bandwidth usage, but images will be lost when the limit is exceeded.

Note that a maximum bit rate can be used for both variable and constant bit rates.

The bit rate type can be set as Variable Bit Rate (VBR) or Constant Bit Rate (CBR). VBR will adjust the bit rate according to the images' complexity, thus using a lot of bandwidth for a lot of activity in the image and less for lower activity in the monitored area.

Note: Depending on the amount of motion, the required bandwidth may increase by 1-15% for each frame.

Video Stream

This parameter can be set to **frame rate** to increase the frame rate by 30% in 4CIF resolution. If the resolution is set to a value lower than 4CIF, the parameter should be set to **bandwidth**.

Audio Settings (AXIS 215 PTZ only)

This section describes how to configure the basic audio settings for the AXIS 215 PTZ, e.g. set the communication mode and adjust the sound levels in the microphone and speaker.

Enable Audio

Check the **Enable Audio** checkbox to enable the audio functionality.

Audio Channels

There are two mono audio channels between the AXIS 215 PTZ and other clients, one for receiving audio and one for transmitting audio. Each audio channel can be turned on or off, which means that there are four **audio mode** options that can be used.

Full-duplex mode means that you can transmit and receive audio (talk and listen) at the same time, without having to use any of the controls. This is just like having a telephone conversation. The only controls you may wish to use are the mute buttons to turn off the sound, and the sliders, to adjust the input/output volume levels. This mode requires that the client PC has a sound card with support for full-duplex audio. If your available bandwidth is 0.2 Mbit/s or less, it is recommended that you use **Half-duplex** mode instead.

Half-duplex mode also transmits and receives audio in both directions, but only in one direction at a time. This means that you must select when to receive or transmit audio using the push-to-talk button. To speak, press and hold the button (check that the microphone is not muted). When finished speaking, release the button. You will now be receiving audio from the other end of the connection.

Note that the push-to-talk button is configured from AMC, see *AXIS Media Control*, on page 9. It is also possible to configure the Push-to-talk button so that it toggles between speaking and listening modes. Half-Duplex mode is best if you only have limited bandwidth available.

When you select **Simplex - Network Camera speaker only** mode, the speaker connected to the AXIS 215 PTZ will play audio, but no audio will be transmitted from the AXIS 215 PTZ to other web clients. This could be used, e.g. to provide spoken instructions to a person seen in the network camera. This mode requires you to use the push to talk button.

Simplex - Network Camera microphone only mode transmits audio from the microphone connected to the AXIS 215 PTZ to any web clients. It will not receive audio from any other web clients. This can be used in remote monitoring, web attractions etc., to provide live audio, as well as video, of a monitored situation.

When using half-duplex, the **Send the sound from the active client to all other clients** option transmits the audio signal from the client that is talking to all the other clients.

Audio Input

If there are problems with the sound input being too low or high, it is possible to adjust the input gain for the microphone connected to the AXIS 215 PTZ.

Source - select Microphone for an external microphone or Line for a Line in device, e.g. an audio mixer for multiple microphones or a microphone with a built-in amplifier.

Input sensitivity - set the sensitivity level of the audio input according to the following:

If **Microphone** is selected - set the **Input sensitivity** to:

- High if the connected microphone is an ordinary (unamplified) microphone, e.g. a computer mic or clip-on mic.
- Low if the connected microphone has a built-in line amplifier.

Enable microphone power - microphone power should only be used with an electret microphone without a battery. This setting should not be enabled when using a dynamic or battery powered microphone.

Input gain - volume control of the audio input. The Input sensitivity levels High and Low are volume settings made earlier in the audio path (see above).

Note: Low Input sensitivity should never be compensated by a high Input gain, as this may cause unwanted noise.

Encoding - select the digital audio encoding format to use.

Bit rate - depending on the selected encoding, set the required bit rate (audio quality). The higher the bit rate, the greater the bandwidth required.

Alarm level - event types in the AXIS 215 PTZ can be set to use this level as a trigger. Each individual event type can be configured to trigger if the sound level rises above or falls below the set value.

The alarm level can be set in the range 0-100%, where 0% is the most sensitive and 100% the least sensitive.

Audio Output

If the sound from the speaker is too low or high it is possible to adjust the **output gain** for the connected active speaker.

When satisfied with the settings, click **Save**, or click **Reset** to revert to the previously saved settings.

Advanced Audio Settings (AXIS 215 PTZ only)

The Advanced Audio settings allows you to tune the external microphone connected to the AXIS 215 PTZ to suit your environment.

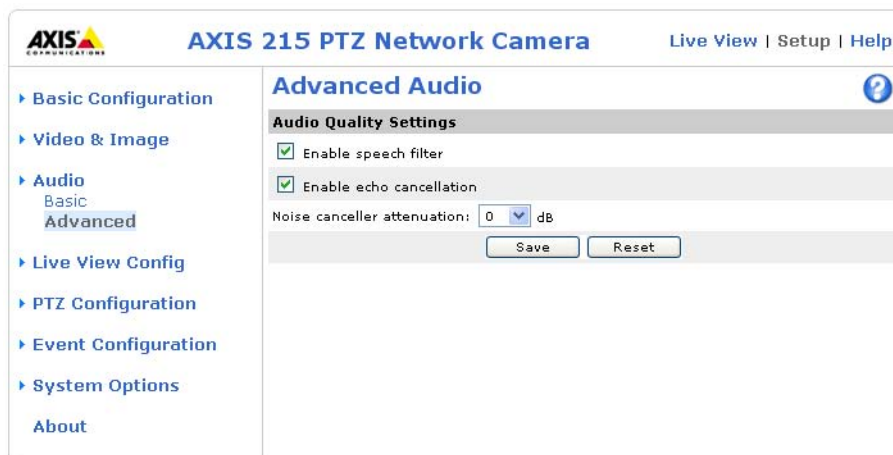

Enable speech filter improves the sound quality when the microphone is placed close to the person talking and can also help reduce background noise. The filter cuts the lowest and the highest frequencies. The bypass frequency range is approximately 250Hz to 3700Hz (measured at -10dB cut-off break points).

Enable echo cancellation reduces acoustic echoing if sound from the speaker is captured by the microphone.

Noise canceling is a way of reducing the background noise when there is no useful audio present. A typical application could be that the camera is set up in a noisy environment, and you are only interested in hearing audio from the AXIS 215 PTZ when someone is speaking close to the microphone.

Noise canceller attenuation - when the incoming sound is louder than the threshold, it will pass without any changes. When lower than the threshold, the incoming sound will be reduced by a certain attenuation factor. The threshold level should be set higher than the background noise, but lower than the useful audio.

There is a trade-off between noise canceling and sound quality. In other words, increasing the **noise canceller attenuation** deteriorates sound quality. Adjust the threshold and the attenuation to an optimum by listening and changing the levels.

Live View Config - Live View Layout

These are the tools for determining the layout of the Live View page. The layout can be set in 3 ways:

- Use Axis look - the layout is unchanged.
- Use custom settings - modify the default page with your own colors, images etc. Click the Configure button and see the following page.
- Own Home Page - upload and use your own custom made page as the default web page. Click the Configure button and see the following page.

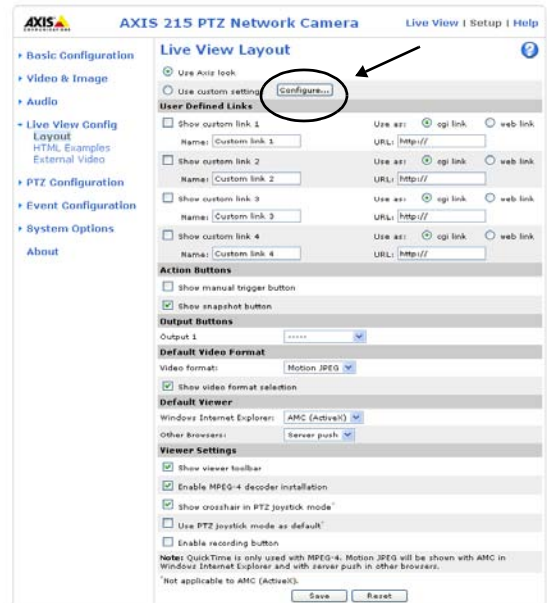

Custom Settings

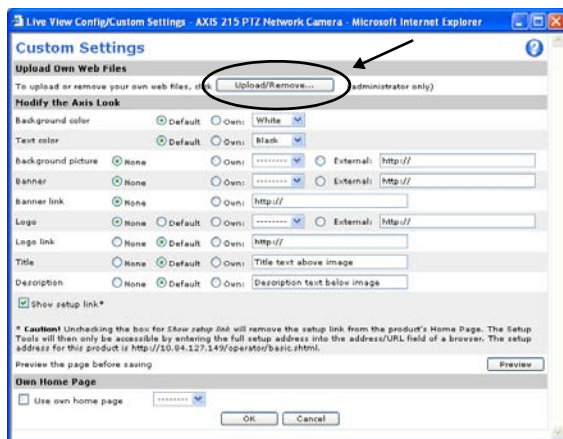

Upload Own Web Files

Your own web files, background picture, color etc. must first be uploaded to the AXIS 215 PTZ/AXIS 215 PTZ-E in order to be available for selection. Once uploaded, the files are shown in the drop-down list.

1. Enter the path to the file, e.g. a file located on your workstation or click the **Browse** button.
2. Select the user level for the uploaded file. Setting the user access level means that you have complete control over which pages can be viewed by which users.
3. When the path is shown correctly in the text field, click the **Upload** button.

All uploaded files are shown in the list in the lower section of the page. To remove a file, check the box provided next to it and then click the **Remove** button.

Modify the Axis Look

Adjust the settings under **Modify the Axis Look**, to change the background color, text color, background picture, banner, banner link, Logo, etc.

- To use your uploaded file, click the **Own** radio button and select the file from the drop-down list.
- To use an external file located somewhere other than in the AXIS 215 PTZ/AXIS 215 PTZ-E, click the **External** radio button and enter the URL to the file (applies to background picture, banner and logo).

Show Setup link

Note that unchecking the box for **Show setup link** will remove the setup link from the camera's Home Page. The setup tools will then only be accessible by entering the full setup address into the address/URL field of a browser, i.e.

`http://<ip address>/operator/basic.shtml`

Own Home Page

To use a previously uploaded web page as the default page, check the checkbox, select the page from the drop-down list and click **OK**.

Note: You can also add live video from the AXIS 215 PTZ/AXIS 215 PTZ-E to your own web site. For further information, please refer to *HTML Examples*, on page 20.

User Defined Links

Enter a descriptive name and enter the URL in the provided field. The link will appear on the Live View page.

User defined CGI links can be used to issue The VAPIX® API requests, e.g. PTZ commands.

Example:

1. Check **Show custom link 1**
2. Enter a descriptive name, e.g. CAM START.
3. Select the **Use as cgi link** radio button and enter the cgi link in the field:

`http://192.168.0.125/axis-cgi/com/ptz.cgi?continuouspan tiltmove=-30,-30`

4. Check **Show custom link 2**.
5. Enter a descriptive name, e.g. CAM STOP.
6. Select the **Use as cgi link** radio button and enter the cgi link in the field:

`http://192.168.0.125/axis-cgi/com/ptz.cgi?continuouspan tiltmove=0,0`

7. These links will appear in the web interface and can be used to control the PTZ camera.

For more information on the The VAPIX® API, see the **Support / Developer** pages on the Axis Website at <http://www.axis.com>

Action Buttons - these buttons can then be used to manually trigger and stop an event from the Live View page. See *Event Servers*, on page 23.

The snapshot button allows users to take a snapshot of the video stream and save it on a computer.

Output Buttons (AXIS 215 PTZ only) - these buttons can then be used to manually start and stop an event from the Live View page, e.g. switch a light on/off:

- The Pulse button activates the port for a defined period
- Active/Inactive displays 2 buttons, one for each action (on/off)

Default Video Format - select default video format from the drop-down list. Check the box to enable video format selection from the Live View Page.

Default Viewer

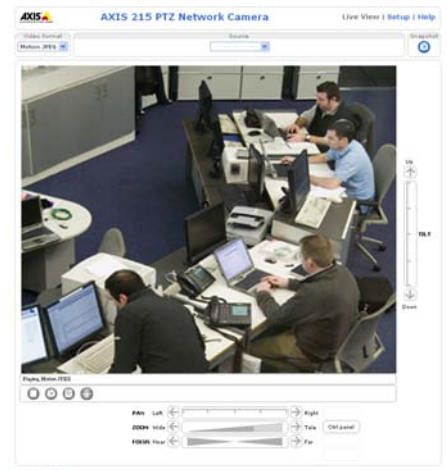

user defined link

When using *Microsoft Internet Explorer (IE)* for Windows, select your preferred method of viewing moving images. The options are:

- **AMC (ActiveX)** - this is the best choice for fast image updating in Internet Explorer for Windows, but might not be possible on computers that have restriction on the installation of additional software.
- **QuickTime** - for use with MPEG-4 only, select this to use the QuickTime plug-in for Microsoft Internet Explorer.
- **Java applet** - this alternative uses a Java applet to update the images in the browser.
- **Still Image** - displays still images only. Hit the **Refresh** button in your browser to view a new image.

When using any other browser than Internet Explorer for Windows, select the appropriate method from the drop-down list for viewing images. The available options are similar to Internet Explorer except for **Server Push**. With this method, the camera maintains and controls an open HTTP connection to the browser and sends data as and when required for as long as required.

Please see the online help  for more information.

Viewer settings

Show viewer toolbar - uncheck to remove the viewer toolbar from the Live View page.

Enable MPEG-4 decoder installation - enables/disables the installation of the MPEG-4 decoder included with AMC.

Show crosshair in PTZ joystick mode - enables/disables a red position indicator in the center of the image when the joystick navigation mode is selected.

Use PTZ joystick mode as default - enabling this sets the PTZ mode to joystick. The mode can temporarily be changed on the Live View page, but will default to joystick if selected.

Enable recording button - enables recording directly from the Live View page. The recording is saved in the folder specified in the Recording tab in the AMC Control Applet. Note that this button is only available when viewing with AMC.

HTML Examples

You can add live video from the AXIS 215 PTZ/AXIS 215 PTZ-E to your own web site. The camera can transmit a Motion JPEG stream to up to 20 simultaneous connections, although an administrator can restrict this to fewer.

Select the preferred **Video Format** from the drop down list. The available options are Motion JPEG, MPEG-4 using AMC and MPEG-4 using QuickTime. If MPEG-4 is set as the video format, note that a separate MPEG-4 license is required for each viewer.

The Motion JPEG selection has additional settings for **Image Type**, **Image size** and other optional settings to configure the video stream to suit your Web page. Click **Update** once satisfied.

The camera generates the required source code for your configuration. Copy this code and paste it into your own Web page code.

External Video

An external video source is a source originating from some other Axis device on the network. The images from these sources can be displayed just as if they were produced by the AXIS 215 PTZ/AXIS 215 PTZ-E.

The External Video Source list shows all of the external video sources currently configured. The information displayed is the name of the source and the path to the video stream. Up to 20 external video sources can be configured. Please see the online help  for more information.

PTZ Configuration

Preset Positions

A preset position is a pre-defined camera view than can quickly and easily be viewed.

From **Preset Position Setup**, use the Pan, Tilt and Zoom (PTZ) controls to steer the camera to the required position. When satisfied with the camera's position, enter a descriptive name. This camera position is then saved as a **preset position**.

The AXIS 215 PTZ/AXIS 215 PTZ-E will take the exact position when the preset's name is selected from the Preset positions drop-down list. Preset positions can be selected in **Live View**, from events and in **Sequence mode**.

One position can be set as the **Home** position, which is readily accessible by clicking on the **Home** button in both the Preset Position Setup window and the Live View window. The position's name will have (H) added, e.g. Office Entrance (H).



Sequence Mode

The Live View page can be configured to rotate through the selected preset positions, in a set order or randomly.

Select the desired preset positions and enter the time to display each position. Click **Save**.



The Sequence buttons will appear on the Live View page to enable the viewer to start and stop the sequence mode.

OSDI Zones

On-Screen Direction Indicator Zones are areas that you define with coordinates and a descriptive name. These zones can then be included in the Image text to aid the viewer in navigating the camera.

The camera uses the coordinates of the center of the image to set the lower left and upper right zone areas. First navigate where you would like the most lower left point of the OSDI Zone to be located. The coordinates are set by clicking on the **Get** button. Proceed to where the upper right point of the zone should be located and click on the corresponding **Get** button. Give the zone a descriptive name and go to *Overlay Image Settings*, on page 13 for information about including the name of OSDI Zone in the Image text.

Advanced – Limits

Define the **pan**, **tilt** and **zoom** limits for the AXIS 215 PTZ/AXIS 215 PTZ-E. Movements to the left and right, up and down can be restricted to narrow the area under surveillance.

Note: The image is automatically flipped over (E-flip) e.g. when the target moves under the camera and then moves on. In situations where E-flip is not desired, set the Lower limit to -90° , which will disable this function.

Move speed - sets the speed of the camera's Pan/Tilt movements. The default setting is maximum speed.

Enable proportional speed - when using a joystick (or emulating one with the mouse), this setting can be used to reduce the maximum pan/tilt movement speed, i.e. the speed the camera moves at when the joystick is pushed all the way out in any pan/tilt direction. This is useful when the camera is zoomed in on an object and a pan/tilt movement is performed

Auto-flip - the AXIS 215 PTZ will simulate continuous pan movement in the same direction, i.e. the camera will pan the full 360 degrees, even though there is a mechanical stop at ± 170 degrees.

This is achieved by reversing the camera lens and flipping it over when the camera reaches the mechanical stop. There will be a slight delay during the lens reversal.

Movement prediction after Auto-flip - the camera will attempt to predict the new position in the pan movement, after compensating for the slight delay while the camera changes direction after an Auto-flip. This is useful for e.g. tracking moving objects or persons when using the joystick or emulated joystick mode.

See the online help for more information.

Advanced - Ctrl Panel

This allows you to add a shortcut command button to the control panel. This requires you to provide the URL (path) to an auxiliary command provided by the PTZ driver, or to some other command accessed via the The VAPIX® API. See the online help for more information.

Advanced - Calibration

The Area zoom functionality on the Live View page provides the possibility to zoom in on an area marked by drawing a square directly in the image. In order to fine-tune the precision of the square, Area zoom should first be calibrated from this page.

Follow the on-screen instructions to calibrate the precision of the zoom.

Control Queue

PTZ Control Queue - the administrator can set up a queue for the PTZ controls. Once set up, the PTZ Control Queue buttons will appear on the Live View page offering one viewer exclusive control for a limited amount of time. Other users will be placed in the queue.

The screenshot shows a control panel titled "PTZ Control Queue". It contains the following elements:

- Status in queue:** A text input field containing "Not in queue".
- Position in queue:** A text input field that is currently empty.
- Time remaining:** A text input field followed by the word "seconds".
- Request control:** A grey button with white text.

PTZ Control Queue on Live View page

Please see the online help [?](#) for more information.

Event Configuration

This section describes how to configure the AXIS 215 PTZ/AXIS 215 PTZ-E for alarm and event handling. The AXIS 215 PTZ/AXIS 215 PTZ-E can be configured to perform certain actions when certain types of events occur.

Event Type	A set of parameters describing how and when the AXIS 215 PTZ/AXIS 215 PTZ-E is to perform certain actions	
Triggered Event page 24	the circumstances that start an event	e.g. at a signal from an external device, such as motion detection
Scheduled Event page 25	the circumstances that start an event	e.g. at a pre-programmed time
Action	what occurs when the event triggers	e.g. uploaded video images to an FTP server, email notification, etc.

Event Servers

Event Servers are used, e.g. for receiving uploaded image files and/or notification messages. To set up Event server connections in your AXIS 215 PTZ/AXIS 215 PTZ-E, go to **Setup > Event Configuration > Event Servers** and enter the required information according to the selected server type.

Server type	Purpose	Required information
FTP Server	<ul style="list-style-type: none"> used for uploading saved images 	<ul style="list-style-type: none"> Descriptive name of your choice Network address (host name or IP address) Upload path e.g. images/ Port number User name/Password Use passive mode if there is a firewall between the PTZ camera and the FTP server Use temporary file if your FTP server doesn't allow an existing file to be overwritten by a new file with the same name
HTTP Server	<ul style="list-style-type: none"> used for notification messages used for uploading saved images 	<ul style="list-style-type: none"> Descriptive name of your choice URL User Name and Password (to HTTP server) Proxy address/Proxy port (if required) Proxy User Name and Password (if required)
TCP Server	<ul style="list-style-type: none"> used for notification messages 	<ul style="list-style-type: none"> Descriptive name of your choice Network address (host name or IP address) Port

For details on each setting, please refer to the online help files  which are available from each web page.

Note: Pre-trigger and Post-trigger buffers will be lost if the connection to the event server fails.

When the setup is complete, the connection can be tested by clicking the Test button (the connection test will take approximately 10 seconds).

Event Types

An **Event Type** is a set of parameters describing how and when the AXIS 215 PTZ/AXIS 215 PTZ-E is to perform certain actions.

Example: If somebody passes a connected sensor and an event type has been configured to act on this, the camera can e.g. record and save images to an FTP server, and/or send a notification email to a pre-configured email address with a pre-configured message. Images can be sent as email attachments.

Triggered Event

A Triggered event is activated from, e.g:

- a switch connected to an input port on the AXIS 215 PTZ
- a manually activated action e.g. from an action button in the web interface
- on restart (reboot) after e.g. power loss

Note: AXIS 215 PTZ-E does not support I/O ports.

How to set up a triggered event

This example describes how to set the AXIS 215 PTZ/AXIS 215 PTZ-E to upload images when the main door is opened:

1. Click **Add triggered** on the **Event types** page.
2. Enter a descriptive **name** for the event, such as Motion Detection. To configure motion detection see page 25.
3. Set the **Priority** - High, Normal or Low (see online help files).
4. Set the **Respond to Trigger...** parameters when the event is to be active, for example. only after office hours.
5. Select the trigger alternative from the **Triggered by...** drop-down list, e.g. on restart.
6. Set the **When Triggered...** parameters i.e. set what the AXIS 215 PTZ/AXIS 215 PTZ-E is to do if motion is detected, e.g. upload images to an FTP server or send an e-mail.
7. Click **OK** to save the Event in the Event Types list.

Please use the online help  for descriptions of each available option. Image file names can be formatted according to specific requirements, such as time/date or type of triggered event. See *File Naming & Date/Time Formats* under *Event Configuration*.

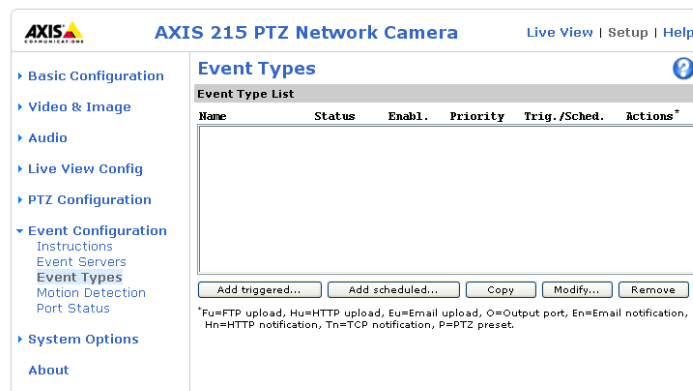

Please use the online help files  for descriptions of each available option.

Pre-trigger and Post-trigger buffers

This function is very useful when checking to see what happened immediately before and after a trigger, e.g. 2 minutes before and after a door has been opened. Check the **Upload images** checkbox under **Event Types > Add Triggered... > When Triggered...** to expand the web page with the available options.

Note: Buffer size - up to 9 MB buffer. The maximum length of time of the pre-/post-buffer depends on the image size and selected frame rate.

Include pre-trigger buffer - images stored internally in the server from the time immediately preceding the trigger. Check the box to enable the pre-trigger buffer, enter the desired length of time and specify the required image frequency.

Include post-trigger buffer - contains images from the time immediately after the trigger. Configure as for pre-trigger.

Note: If the pre- or post-buffer is too large for the internal memory, the frame rate will be reduced and individual images may be missing. If this occurs, an entry will be created in the unit's log file.

Continue image upload (unbuffered) - enable the upload of images for a fixed length of time. Specify the length of time for the uploaded recording, in seconds, minutes or hours, or for as long as the trigger is active. Finally, set the desired image frequency to the maximum (the maximum available) or to a specified frame rate. The frame rate will be the best possible, but might not be as high as specified, especially if uploading via a slow connection.

Scheduled Event

A **Scheduled** event can be activated at pre-set times, in a repeating pattern on selected weekdays.

How to set up a scheduled event

This example describes how to set the AXIS 215 PTZ/AXIS 215 PTZ-E to send an email notification with saved images from a set time:

1. Click **Add scheduled** on the **Event types** page.
2. Enter a descriptive **name** for the event, e.g. Scheduled email.
3. Set the **Priority** (High, Normal or Low).
4. Set the **Activation Time** parameters (24h clock) when the event is to be active, e.g. start on Fridays at 18.00 with a duration of 62 hours.
5. Set the **When Activated...** parameters i.e. set what the AXIS 215 PTZ/AXIS 215 PTZ-E is to do at the specified time e.g. send uploaded images to an email address.
6. Click **OK** to save the Event in the Event Types list.

Please use the online help files  for descriptions of each available option.

Motion Detection

In the Motion Detection menu, you can configure the AXIS 215 PTZ/AXIS 215 PTZ-E for motion detection. The motion detection feature is used to generate an alarm whenever movement occurs (or stops) in the image. The AXIS 215 PTZ/AXIS 215 PTZ-E can use a maximum of 10 Include/Exclude windows.

- **Include** windows target specific areas within the image
- **Exclude** windows are areas to be ignored within the Include window

Once configured, the motion detection windows will appear in a list when motion detection is selected to trigger an event. See *How to set up a triggered event* above.

Note: Using the motion detection feature may decrease overall performance in the camera.

Motion detection will not function while the lens is moving (i.e. pan, tilt, zoom)

How to configure Motion Detection

This example describes how to configure motion detection:

1. Click **Motion Detection** in the **Event Configuration** menu.
2. Click the **Configure Included Windows** radio button.
3. Click **New**.
4. Enter a descriptive name of your choice under **Windows name**.
5. Adjust the size (drag the bottom right-hand corner) and position (click on the text at the top and drag to the desired position).
6. Adjust the Object size, History and Sensitivity profile sliders (see table below for details). Any detected motion within an active window is then indicated by red peaks in the **Activity** window (the active window has a red frame).
7. Click **Save**.

If there are parts of the Include window that you wish to exclude, click the **Configure Excluded Windows** radio button and repeat steps 1-7 above.

Please use the online help  for descriptions of each available option.

Parameter	Size	History	Sensitivity
High	Only very large objects trigger motion detection	An object that appears in the region will trigger the motion detection for a long period	Ordinary colored objects against ordinary backgrounds will trigger the motion detection
Low	Even very small objects trigger motion detection	An object that appears in the region will trigger motion detection for only a very short period	Only very bright objects against a dark background will trigger motion detection
Default values	Low	Medium to High	Medium to High

Examples:

- Avoid triggering on small objects in the image by selecting a high size level.
- To trigger motion detection as long as there is activity in the area, select a high history level.
- To only detect flashing light, low sensitivity can be selected. In other cases, a high sensitivity level is recommended.

Port Status (AXIS 215 PTZ only)

Under **Event Configuration > Port Status** there is a list that shows the status for the connected inputs and outputs of the AXIS 215 PTZ for the benefit of the Operator who cannot access the **System Options** section.

Example: If the Normal state for a push button connected to an input is set to **Inactive** – as long as the button is not pushed, the state is **inactive**. If the button is pushed, the state of the input changes to **active**.

System Options

Security

User access control is enabled by default, the administrator sets the root password on first access. Other users are authorized with user names and passwords, or the administrator can choose to allow anonymous viewer login to the Live View page, as described below:

Users - the user list displays the authorized users and access levels:

- **Viewer** - the lowest level of access, which only allows the user access to the Live View page.
- **Operator** - an Operator can view the Live View page, create and modify event types and adjust certain other settings. The Operator does not have access to the Systems Options configuration pages.
- **Administrator** - an administrator has unrestricted access to the Setup Tools and can determine the registration of all other users.

User Settings - check the corresponding checkboxes to enable:

- **Anonymous viewer login** - allows any viewer direct access to the Live View page.
- **Maximum number of simultaneous viewers** - enter a value here to restrict the number of unicast viewers accessing the unit. This is useful if you need to save on bandwidth. (Note that all multicast viewers count as 1 viewer.)
- **Anonymous PTZ control login** - allows any viewer access to the Pan/Tilt/Zoom controls on the Live View page.

IP Address Filter

Enable IP Address Filtering - to allow or deny access to the AXIS 215 PTZ/AXIS 215 PTZ-E, check the box **Enable IP address filtering**. Once enabled, the IP addresses in the list will be allowed or denied access according to the choice made in the drop-down list **Allow/Deny the following IP addresses**.

The administrator can add up to 256 IP address ranges or single IP addresses to the **Filtered IP Addresses** list. If IP address filtering is enabled, the AXIS 215 PTZ/AXIS 215 PTZ-E will allow or deny requests coming from the IP addresses in the list.

See the IP address filtering help files  for information on how to add IP address ranges.

The users from these IP addresses need to be specified in the user list with the appropriate access rights (**User**, **Operator** or **Administrator**).

Referrals - to prevent unauthorized sources from including the video stream from the AXIS 215 PTZ/AXIS 215 PTZ-E into external Web pages, check the **Referrals** checkbox and enter the IP address or Host name of the computer that hosts the Web pages with the included video stream. Several IP addresses/host names can be defined and are separated by semicolons(;

HTTPS

For greater security, the AXIS 215 PTZ/AXIS 215 PTZ-E can be configured to use HTTPS (Hypertext Transfer Protocol over SSL (Secure Socket Layer)). That is, all communication that would otherwise go via HTTP will instead go via an encrypted HTTPS connection.

Certificate - to use HTTPS for communication with the AXIS 215 PTZ/AXIS 215 PTZ-E, a **Certificate** must be created using one of the following methods:

- A self-signed certificate can be created in the network camera, but this does not guarantee the same level of security as an official certificate.
- An official certificate issued by a CA (Certificate Authority). A CA issues and manages security credentials and public keys for message encryption.

1. Click either **Create self-signed certificate** or **Create Certificate Request** and enter the required information in the provided fields.
2. Click **OK**.
3. **Create self-signed certificate** generates and installs a certificate which will be displayed under **Installed Certificate**.
Create Certificate Request generates a PEM formatted request which you copy and send to a CA for signing. When the signed certificate is returned, click **Install signed certificate...** to install the certificate in the AXIS 215 PTZ/AXIS 215 PTZ-E.
4. Set the **HTTPS Connection Policy** for the administrator, Operator and Viewer to enable HTTPS connection (set to HTTP by default)

Please refer to the home page of your preferred CA for information on where to send the request etc. For more information, please refer to the online help files [?](#)

802.1X - Network Admission Control

IEEE 802.1X is an IEEE standard for port-based Network Admission Control. It provides authentication to devices attached to a network port (wired or wireless), establishing a point-to-point connection, or, if authentication fails, preventing access on that port. 802.1X is based on EAP (Extensible Authentication Protocol).

In an 802.1X enabled network switch, clients equipped with the correct software can be authenticated and allowed or denied network access at the Ethernet level.

Clients and servers in an 802.1X network may need to authenticate each other by some means. In the Axis implementation this is done with the help of digital certificates provided by a **Certification Authority**. These are then validated by a third-party entity, such as a **RADIUS server**, examples of which are Free Radius and Microsoft Internet Authentication Service.

To perform the authentication, the RADIUS server uses various EAP methods/protocols, of which there are many. The one used in the Axis implementation is EAP-TLS (EAP-Transport Layer Security).

The AXIS network video device presents its certificate to the network switch, which in turn forwards this to the RADIUS server. The RADIUS server validates or rejects the certificate and responds to the switch, and sends its own certificate to the client for validation. The switch then allows or denies network access accordingly, on a pre-configured port.

The authentication process

1. A CA server provides the required signed certificates.
2. The Axis video device requests access to the protected network at the network switch. The switch forwards the video device's CA certificate to the RADIUS server, which then replies to the switch.
3. The switch forwards the RADIUS server's CA certificate to the video device, which also replies to the switch.
4. The switch keeps track of all responses to the validation requests. If all certificates are validated, the Axis video device is allowed access to the protected network via a pre-configured port.

RADIUS (Remote Authentication Dial In User Service) - AAA (Authentication, Authorization and Accounting) protocol for applications such as network access or IP mobility. It is intended to work in both local and roaming situations.

CA servers - In cryptography, a Certification Authority (CA) is an entity that provides signed digital certificates for use by other parties, thus acting a trusted third party. There are many commercial CA's that charge for their services. Institutions and governments may have their own CA, and there are free CA's available.

Date & Time

Current Server Time - displays the current date and time (24h clock). If this has not been configured, the time displayed is the default setting. The time can be displayed in 12h clock format in the Overlay Images (see below).

New Server Time - Select your time zone from the drop-down list and check the daylight saving time changes, if desired.

From the **Time Mode** section, select the preferred method to use for setting the time:

- **Synchronize with computer time** - sets the time from the clock on your computer.
- **Synchronize with NTP Server** - the AXIS 215 PTZ/AXIS 215 PTZ-E will obtain the time from an NTP server every 60 minutes. Specify the NTP server's IP address or host name.
Note that if using a host name for the NTP server, a DNS server must be configured under TCP/IP settings. See Network > TCP/IP below.
- **Set manually** - this option allows you to manually set the time and date.

Date & Time Format Used in Images - specify the formats for the date and time (12h or 24h) displayed in the Live View video streams.

Use the predefined formats or use your own custom date and time formats. See **Advanced File Naming & Date/Time Formats** in the help files  for information on how to create your own file formats.

Network

Basic TCP/IP Settings

The AXIS 215 PTZ/AXIS 215 PTZ-E supports both IP version 4 and IP version 6. Both versions may be enabled simultaneously, and at least one version must always be enabled.

IPv4 Address Configuration - when using IPv4, the IP address for the AXIS 215 PTZ/AXIS 215 PTZ-E can be set automatically via DHCP, or a static IP address can be set manually.

IPv6 Address Configuration - If IPv6 is enabled, the AXIS 215 PTZ/AXIS 215 PTZ-E will receive an IP address according to the configuration in the network router.

There are also options for setting up notification of changes in the IP address, and for using the AXIS Internet Dynamic DNS Service. For more information on setting the IP address, please see the online help.

- Notes:**
- DHCP is a protocol for automatic IP address assignment on a network. IP address assignment via DHCP may lead to the situation where the IP address changes and you lose contact. Configure the options for notification of IP address change (under Services) to receive notification from the network camera when the IP address changes.
 - Alternatively, if your DHCP server can update a DNS server, you can access the AXIS 215 PTZ/AXIS 215 PTZ-E by host name which is always the same, regardless of the IP address.

For more information, please refer to the online help files .

Services

Enable ARP/Ping setting of IP address - The IP address can be set using the ARP/Ping method, which associates the unit's MAC address with an IP address. Check this box to enable the service. Leave disabled to prevent unintentional resetting of the IP address.

- Notes:**
- The ARP/Ping service is automatically disabled 2 minutes after the unit is started, or as soon as an IP address is set.
 - Pinging the unit will still be possible when this service is disabled.

Options for notification of IP address change - if the IP Address for the AXIS 215 PTZ/AXIS 215 PTZ-E is changed automatically, e.g. by DHCP, you can choose to be notified. Click **Settings...** and enter the required information.

AXIS Internet Dynamic DNS Service - If the AXIS 215 PTZ/AXIS 215 PTZ-E has been registered with the Axis Internet Dynamic DNS service and the IP address for the product changes, the service is updated to reflect the change. Check the box to enable/disable automatic updates.

The domain name currently registered at the Axis Internet Dynamic DNS service for your product can at any time be removed. To do this click **Settings...** and follow the instructions.

For more information, please refer to the online help files 

Advanced TCP/IP Settings

DNS Configuration - DNS (Domain Name Service) provides the translation of host names to IP addresses on your network.

Obtain DNS server address via DHCP - automatically use the DNS server settings provided by the DHCP server. Click the **View** button to see the current settings.

Use the following **DNS server address** - enter the desired DNS server by specifying the following:

- **Domain name** - enter the domain(s) to search for the host name used by the AXIS 215 PTZ/AXIS 215 PTZ-E. Multiple domains can be separated by semicolons (;). The host name is always the first part of a Fully Qualified Domain Name, e.g. myserver is the host name in the Fully Qualified Domain Name myserver.mycompany.com where mycompany.com is the Domain name.
- **Primary DNS server** - enter the IP address of the primary DNS server.
- **Secondary DNS server** - will be used if the primary DNS server is unavailable.

NTP Configuration - The AXIS 215 PTZ/AXIS 215 PTZ-E can obtain the correct time from an NTP server. The address for the NTP server can either be obtained via the DHCP server, or it can be entered manually.

Host Name Configuration - The AXIS 215 PTZ/AXIS 215 PTZ-E can be accessed using a host name, instead of an IP address. The host name is usually the same as the assigned DNS Name. It is always the first part of a Fully Qualified Domain Name and is always one word, with no period. For example, **myserver** is the host name in the Fully Qualified Domain Name myserver.mycompany.com.

The **enable dynamic DNS updates** allows you to alias a dynamic IP address to a static host name, allowing your computer to be more easily accessed from various locations on the Internet. Outside users can always access your server using the associated DNS name regardless of the WAN IP. The DNS server used by the user and/or the DNS server responsible for the domain in use must support RFC2136 and allow updates from the camera.

The **TTL (Time To Live)** value determines how long (in seconds) the reply from the DNS server should be remembered when checking that the domain name for the registered IP address is still valid.

Link-Local IPv4 Address

This is enabled by default and assigns the AXIS 215 PTZ/AXIS 215 PTZ-E an additional IP address for use with UPnP™. The AXIS 215 PTZ/AXIS 215 PTZ-E can have both a Link-Local IP and a static/DHCP-supplied IP address at the same time - these will not affect each other.

HTTP - The default HTTP port number (port 80) can be changed to any port within the range 1024-65535. This is useful for e.g. simple security port mapping.

HTTPS - If applicable, enter the HTTPS port the AXIS 215 PTZ/AXIS 215 PTZ-E will use. The default setting (443) can be changed to any port within the range 1024-65535. HTTPS is used to provide encrypted web browsing.

NAT Traversal (port mapping) for IPv4 - Use NAT traversal when your AXIS 215 PTZ/AXIS 215 PTZ-E is located on an intranet (LAN) and you wish to make it available from the other (WAN) side of a NAT router. With NAT traversal properly configured, all HTTP traffic to an external HTTP port in the NAT router will be forwarded to the network camera.

Enable/Disable - When enabled, the AXIS 215 PTZ/AXIS 215 PTZ-E will attempt to configure port mapping in a NAT router on your network, using UPnP™.

Use manually selected NAT router - Select this option to manually select a NAT router. Enter the IP address for the router in the field provided.

If a router is not manually specified, the AXIS 215 PTZ/AXIS 215 PTZ-E Network Camera will automatically search for NAT routers on your network. If more than one router is found, the default router will be selected.

Alternative HTTP port - Select this option to manually define an external HTTP port. Enter the port number in the field provided. If no port is entered here a port number will automatically be selected when NAT traversal is enabled.

FTP - The FTP server running in the AXIS 215 PTZ/AXIS 215 PTZ-E enables the upload of e.g. new firmware, user applications, etc. Check the box to enable the service.

RTSP - The RTSP protocol allows a connecting client to start an MPEG-4 stream. Enter the RTSP port number to use. The default setting is 554.

Network Traffic

The default setting is **Auto-negotiate** which means that the correct speed is automatically selected. If necessary, you can set the connection speed by selecting it from the drop-down list. 10BaseT (Half/Full Duplex), 100BaseTX (Half/Full Duplex).

Maximum bandwidth - Specify, in Mbit/s or Kbit/s, the maximum bandwidth that the AXIS 215 PTZ/AXIS 215 PTZ-E is allowed to use on your network. This is a useful function when connecting the AXIS 215 PTZ/AXIS 215 PTZ-E to busy or heavily loaded networks. The default setting is **Unlimited**.

For more information, please refer to the online help files 

Network - SOCKS

SOCKS is a networking proxy protocol. The AXIS 215 PTZ/AXIS 215 PTZ-E can be configured to use a SOCKS server to reach networks on the other side of a firewall/proxy server. This functionality is useful if the AXIS 215 PTZ/AXIS 215 PTZ-E is located on a local network behind a firewall, but notifications, uploads, alarms, etc., need to be sent to a destination outside the local network (e.g. to the Internet).

Network - QoS (Quality of Service)

Quality of Service (QoS) provides the means to guarantee a certain level of a specified resource to selected traffic on a network. Quality can be defined as e.g. a maintained level of bandwidth, low latency, no packet losses, etc. The main benefits of a QoS-aware network can be summarized as:

- The ability to prioritize traffic and thus allow critical flows to be served before flows with lesser priority.
- Greater reliability in the network, thanks to the control of the amount of bandwidth an application may use, and thus control over bandwidth races between applications.

The QoS in Axis network video products marks the data packets for various types of network traffic originating from the product. This makes it possible for network routers and switches to e.g. reserve a fixed amount of bandwidth for these types of traffic. The types of traffic marked by the camera are video, audio, event/alarm and management network traffic.

QoS DSCP Settings

For each type of network traffic supported by your Axis network video product, enter a DSCP (Differentiated Services Codepoint) value. This value is used to mark the traffic's IP header. When the marked traffic reaches a network router or switch, the DSCP value in the IP header tells the router or switch which type of treatment to apply to this type of traffic, for example, how much bandwidth to reserve for it.

Note that DSCP values can be entered in decimal or hex form, but saved values are always shown in decimal. For more information on Quality of Service, please see the Axis support web at www.axis.com/techsup

Network - SMTP (email)

Simple Mail Transfer Protocol (SMTP) - enter the host names or addresses for your primary and secondary mail servers in the fields provided to enable event and error email messages from the AXIS 215 PTZ/AXIS 215 PTZ-E to predefined addresses, via SMTP.

Network - SNMP

The Simple Network Management Protocol (SNMP) allows remote management of network devices. Depending on the level of security required, select the version of SNMP to use. The three levels of security are:

- SNMP V1 - includes no security.
- SNMP V2c - uses simple security. The community name can be specified as a password for read or read/write access to all supported SNMP objects. The community is the group of network devices using SNMP.
- SNMP V3 - provides encryption and secure passwords. HTTPS must be enabled.

Network - UPnP

The AXIS 215 PTZ/AXIS 215 PTZ-E includes support for UPnP in Windows Millennium and Windows XP. UPnP is enabled by default.

Note: UPnP must be installed on your workstation. To do this, open the Control Panel from the **Start Menu** and select **Add/Remove Programs**. Select **Add/Remove Windows Components** and open the **Networking Services** section. Click **Details** and then select **UPnP**.

Network - RTP/MPEG-4

Multicast must be enabled for these settings to take effect. The settings are only valid when MPEG-4 is used as the video format. These settings are the port range, IP address, port number, and Time-To-Live value to use for the video stream(s) in MPEG-4 format. Only certain IP addresses and port numbers should be used for multicast streams.

Enter the port range, IP address and the port number to use for the video and audio streams in the required fields. (AXIS 215 PTZ-E does not support audio.)

Only IP addresses within certain ranges can be used for multicasting. The camera has been pre-configured with an address from these ranges, and this does not normally need to be changed. Please contact your network administrator if you have special requirements.

- Notes:**
- Viewers do not need to know this IP address or port number, but simply the main IP address or host name otherwise used for accessing the camera.
 - Setting the video port number to 0 means a random port number will be used.

If IP packets (i.e. data) fail to be delivered to their destination within a reasonable length of time the number entered in the Time to live field tells the network routers when to discard the packet. The value is usually measured in 'hops', i.e. the number of network routers that can be passed before the packet arrives at its destination or is dropped.

Network - Bonjour

The AXIS 215 PTZ/AXIS 215 PTZ-E includes support for Bonjour. When enabled, the camera is automatically detected by operating systems and clients that support this.

Ports & Devices - I/O Ports (for AXIS 215 PTZ only)

Ports can be given descriptive names and their Normal state can be configured.

The 2 options for Normal state are Open circuit and Grounded circuit. The input is activated when the Current state changes so that it no longer equals the Normal state.

As an example, if the Normal state for a pushbutton connected to an input is Open circuit, this means that as long as the button is not pushed (and the Current state remains as Open Circuit), the state will be inactive.

For more information, please refer to the online help files 

Maintenance

- **Restart** - the unit is restarted without changing any of the settings. Use this method if the unit is not behaving as expected.
- **Restore** - the unit is restarted and most current settings are reset to factory default values. The settings that will not be reset are as follows:
 - boot protocol (DHCP or static)
 - static IP address
 - default router
 - subnet mask
 - system time
- **Default** - the Factory default button should be used with caution. Pressing this button will reset all of the AXIS 215 PTZ/AXIS 215 PTZ-E's settings to the factory default values (including the IP address).

PTZ Status - click the Test button to check the pan, tilt, zoom mechanics and camera for errors. If you receive an error message as the result of this test, contact Axis Customer Services at www.axis.com/techsup

Upgrade Server - See *Updating the Firmware*, on page 37.

Backup - click the Backup button to take a backup of all of the parameters, and any user-defined scripts. If necessary, it is then possible to return to the previous settings if the settings are changed and there is unexpected behavior.

Note: The root password will also be reset to the password saved in the backup file.

Restore - click the Browse button to locate the saved backup file (see above) and then click the Restore button. The settings will be restored to the previous configuration.

Note: Backup and Restore can only be used on the same unit running the same firmware. This feature is not intended for multi-configurations or for firmware upgrades.

Support

The **support overview** page provides valuable information on troubleshooting and contact information, should you require technical assistance.

Support - System Overview is a quick look over the camera's status and settings. Information that can be found here includes the camera's Firmware version, IP address, Security, Event and Image settings and Recent log items. Many of the captions are also links to the proper **Setup** page to conveniently make adjustments in the camera's settings.

Support - Logs & Reports - when contacting Axis support, please be sure to provide all relevant information:

Logs - the **Log** report including all log information

Reports - the **Server Report** and **Parameter List** provide valuable information for troubleshooting, be sure to include the server report when contacting Axis' support service.

Configuration

- **Log Level for Log Files** - from the drop-down list, select the level of information to be added to the Log file
- **Log Level for Email** - from the drop-down list, select the level of information to send as email and enter the destination email address.

Advanced

Scripting is an advanced function that provides the possibility to customize and use scripts. This function is a very powerful tool.

Caution!

Improper use may cause unexpected behavior or even cause loss of contact with the unit. If a script does cause problems, reset the unit to its factory default settings. A backup file may be of use to return the unit to its latest configuration.

Axis strongly recommends that you do not use this function unless you fully understand the consequences. Note that Axis support does not provide assistance for problems with customized scripts.

For more information, please visit the Developer pages at www.axis.com/developer

Plain Config - this function is for the advanced user with experience of Axis network camera configuration. All parameters can be set and modified from this page. Help is available from the standard help pages.

Resetting to Factory Default Settings

To reset the AXIS 215 PTZ/AXIS 215 PTZ-E to the original default settings, go to the **System Options > Maintenance** web page (described in *Maintenance*, on page 33) or use the **Reset** button on the **AXIS 215 PTZ/AXIS 215 PTZ-E** as described below:

Using the Reset Button

Follow the instructions below to reset the AXIS 215 PTZ/AXIS 215 PTZ-E to factory default settings using the **Reset Button**.

1. Switch off the AXIS 215 PTZ/AXIS 215 PTZ-E by disconnecting the power supply.
2. Press and hold the **Reset** button while you reconnect the power connector.
3. Keep the **Reset** button pressed for approximately 15 seconds.
4. Release the **Reset** button.

Note: Resetting to the factory default settings using the **Reset Button** will cause all parameters (including the IP address) to be reset. Refer to *Maintenance*, on page 33 for other methods that do not reset the IP address.

Unit Connectors

This section describes the following:

- The I/O terminal block (for AXIS 215 PTZ only)
- LED indicators
- Power connection

Note: AXIS 215 PTZ-E does not support audio and does not have I/O ports.

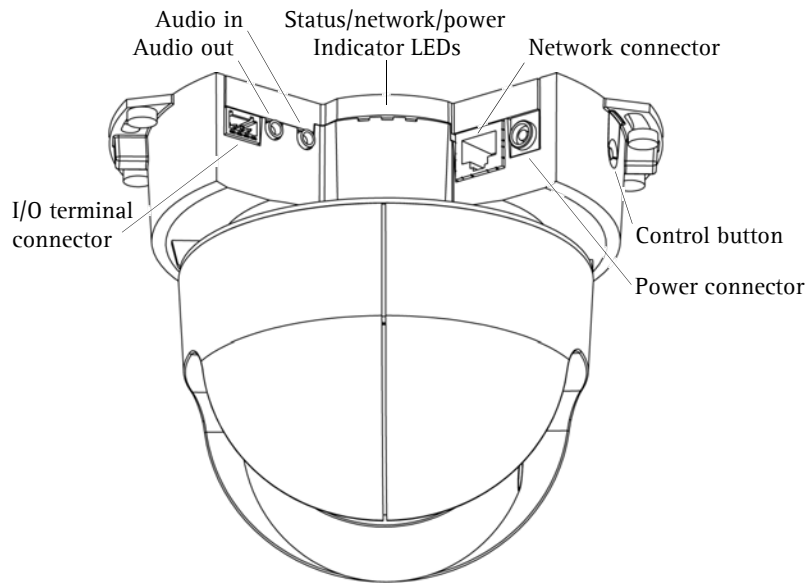

AXIS 215 PTZ Network Camera

I/O terminal connector (for AXIS 215 PTZ only)

Used in applications for e.g. motion detection, event triggering, time lapse recording and alarm notifications. It provides the interface to:

- 1 transistor output - For connecting external devices such as relays and LEDs. Connected devices can be activated by VAPIX®, output buttons on the Live View page or by an Event Type. The output will show as active (shown under Event Configuration > Port Status) if the alarm device is activated.
- 1 digital input - An alarm input for connecting devices that can toggle between an open and closed circuit, for example: PIRs, door/window contacts, glass break detectors, etc. When a signal is received the state changes and the input becomes active (shown under Event Configuration > Port Status).
- Auxiliary power and GND

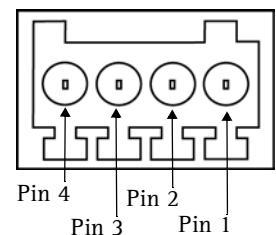

Function	Pin number	Notes	Specifications
GND	1	Ground	
12V DC Power	2	Can be used to power auxiliary equipment. Note that the AXIS 215 PTZ itself cannot be powered via the I/O terminal connector.	Max load = 100mA
Digital Input	3	Connect to GND to activate, or leave floating (or unconnected) to deactivate.	Must not be exposed to voltages greater than 12V DC
Transistor Output	4	Uses an open-collector NPN transistor with the emitter connected to the GND pin. If used with an external relay, a diode must be connected in parallel with the load, for protection against voltage transients.	Max load = 100mA Max voltage = 24V DC (to the transistor)

Network connector - RJ-45 Ethernet connector. Using shielded cables is recommended.

Power connector - Mini DC connector 12V DC $\pm 5\%$, max 11.5W. See product label for \pm connection.

Audio in - 3.5mm input for a mono microphone, or a line-in mono signal (left channel is used from a stereo signal).

Audio out - Audio output (line level) that can be connected to a public address (PA) system or an active speaker with a built-in amplifier. A pair of headphones can also be attached. A stereo connector must be used for the audio out.

Connection diagram

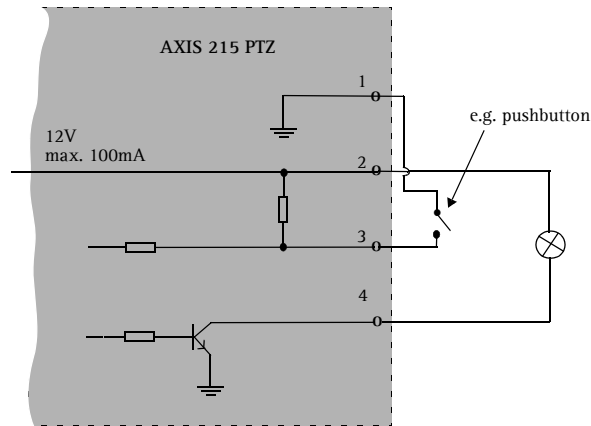

LED indicators

LED	Color	Indication
Network	Green	Steady for connection to a 100 Mbit/s network. Flashes for network activity.
	Amber	Steady for connection to 10 Mbit/s network. Flashes for network activity.
	Unlit	No network connection.
Status	Green	Steady green for normal operation.
	Amber	Steady during startup, during reset to factory default or when restoring settings.
	Red	Slow flash for failed upgrade.
Power	Green	Normal operation.
	Amber	Flashes green/amber during firmware upgrade.

Power connection

Connect the supplied indoor power adapter to the power connector in the camera casing.

Troubleshooting

Checking the Firmware

The firmware is software that determines the functionality of the AXIS 215 PTZ/AXIS 215 PTZ-E. When you download firmware from the Axis Website, your Axis product will receive the latest available functionality.

One of your first actions when troubleshooting a problem should be to check the currently installed firmware version. The latest version may contain a correction that fixes your particular problem. The current software version in your AXIS 215 PTZ/AXIS 215 PTZ-E is available under **Setup > Basic Configuration**.

Updating the Firmware

New firmware can be downloaded to the AXIS 215 PTZ/AXIS 215 PTZ-E over the network. Always read the upgrade instructions available with each new release, before updating the firmware.

1. Save the firmware file to your computer. The latest version of the AXIS 215 PTZ/AXIS 215 PTZ-E firmware is available free of charge from the Axis Website at <http://www.axis.com/techsup> or from your local distributor.
2. Go to **Setup > System Options > Maintenance** in the AXIS 215 PTZ/AXIS 215 PTZ-E Web pages.
3. In the **Upgrade Server** section and browse to the firmware file on your computer. Click **Upgrade**.
4. Wait at least 20 minutes before restarting the AXIS 215 PTZ/AXIS 215 PTZ-E after upgrading.

- Notes:**
- Pre-configured and customized settings will be retained for use when the new firmware is running (providing that the features are available in the new firmware) although this is not guaranteed by Axis Communications.
 - After starting the process, you should always wait at least 20 minutes before restarting the AXIS 215 PTZ/AXIS 215 PTZ-E, even if you suspect the procedure has failed.
 - Your dealer reserves the right to charge for any repair attributable to faulty updating by the user.

Customer Services

If you contact the Axis support desk, please help us help you resolve your problems expediently by providing a server report, log file and a brief description of the problem.

Server Report - go to **Setup > System Options > Support Overview**. The server report contains important information about the server and its software, as well as a list of the current parameters.

Log file - go to **Setup > System Options > Logs & Reports**. The Log file records events within the unit since the last restart of the system and can prove a useful diagnostic tool for troubleshooting.

The screenshot shows the web interface for an AXIS 215 PTZ Network Camera. The page title is "AXIS 215 PTZ Network Camera" with navigation links for "Live View", "Setup", and "Help". A left sidebar contains a menu with categories like "Basic Configuration", "Video & Image", "Audio", "Live View Config", "PTZ Configuration", "Event Configuration", "System Options" (with sub-items: Security, Date & Time, Network, Ports & Devices, Maintenance, Support), "Support Overview" (with sub-items: System Overview, Logs & Reports, Advanced), and "About". The main content area is titled "Support Overview" and includes sections for "Troubleshooting" (advising to try a guide first), "Server Report" (advising to attach it when contacting support), and "Axis Support Services" (providing instructions on how to get technical assistance, including downloading documentation, searching the FAQ, and reporting problems to support staff via a private support area. It also provides the URL www.axis.com/techsup/ for the Axis Support Web.

Symptoms, Possible Causes and Remedial Actions

Problems setting the IP address

Using ARP Ping	The IP address must be set within two minutes after the power has been applied to the AXIS 215 PTZ/AXIS 215 PTZ-E, restart the server and try again. Also, make sure the ping length is set to 408.
The AXIS 215 PTZ/AXIS 215 PTZ-E is located on a different subnet	If the IP address intended for the AXIS 215 PTZ/AXIS 215 PTZ-E and the IP address of your computer are located on different subnets, you will not be able to set the IP address. Contact your network administrator for an IP address on the same subnet as the computer you are performing the installation from.
The IP address is being used by another device	Disconnect power from the AXIS 215 PTZ/AXIS 215 PTZ-E. Run the Ping command (in a Command/DOS window, type ping and the IP address of the unit). If you receive: Reply from <IP address>: bytes = 32; time = 10 ms..... - this means that the IP address may already be in use by another device on your network. You must obtain a new IP address and reinstall the unit. If you receive: Request timed out - this means that the IP address is available for use with your AXIS 215 PTZ/AXIS 215 PTZ-E. In this case, check all cabling and reinstall the unit.

The AXIS 215 PTZ/AXIS 215 PTZ-E cannot be accessed from a browser

The IP address has been changed by DHCP	1) Move the AXIS 215 PTZ/AXIS 215 PTZ-E to an isolated network or to one with no DHCP or BOOTP server. Set the IP address again, using the ARP Ping command. 2) Access the unit and disable BOOTP and DHCP in the TCP/IP settings. Return the unit to the main network. The unit now has a fixed IP address that will not change. 3) As an alternative to 2), if dynamic IP address via DHCP or BOOTP is required, select the required service and then configure IP address change notification from the network settings. Return the unit to the main network. The unit will now have a dynamic IP address, but will notify you if the address changes.
Other networking problems	Test the network cable by connecting it to another network device, then Ping that device from your workstation.

Cannot send notifications, uploads, alarms, etc, to a destination outside the local network.

Firewall protection	The AXIS 215 PTZ/AXIS 215 PTZ-E can be configured to use a SOCKS server to reach networks on the other side of a firewall/proxy server.
---------------------	---

Your AXIS 215 PTZ/AXIS 215 PTZ-E is accessible locally, but not externally

Firewall protection	Check the Internet firewall with your system administrator.
Default routers required	Check if you need to configure the default router settings.
The Internet site is too heavily loaded	Use a script running on your web server to relay images from the AXIS 215 PTZ/AXIS 215 PTZ-E to the Internet.

A firmware upgrade has been interrupted or the firmware has in some other way been damaged	A rescue firmware is running in the product. First, set the IP address using AXIS IP utility or ARP and Ping, Then, from a Web browser, access the unit and download the latest firmware to the product, see <i>Updating the Firmware</i> , on page 37.
--	---

Problems with the MPEG-4 format

No MPEG-4 displayed in the client.	Check that the correct network interface is selected in the AMC control panel applet (network tab). Check that the relevant MPEG-4 connection methods are enabled in the AMC control panel applet (network tab). In the AMC control applet, select the MPEG-4 tab and click the button Set to default MPEG-4 decoder.
No multicast MPEG-4 displayed in the client.	Check with your network administrator that the multicast addresses used by the AXIS 215 PTZ/AXIS 215 PTZ-E are valid for your network. Check with your network administrator to see if there is a firewall preventing viewing.
Multicast MPEG-4 only accessible by local clients.	Check if your router supports multicasting, or if the router settings between the client and the server need to be configured. The TTL (Time To Live) value may need to be increased.
Poor rendering of MPEG-4 images	Color depth set incorrectly on clients. Set to 16-bit or 32-bit color. If text overlays are blurred, or if there are other rendering problems, you may need to enable Advanced Video Rendering from the MPEG-4 tab in the AMC control panel applet. Ensure that your graphics card is using the latest device driver. The latest drivers can usually be downloaded from the manufacturer's website.
Color saturation is different in MPEG-4 and Motion JPEG.	Modify the settings for your graphics adapter. Please see the adapter's documentation for more information.
Lower frame rate than expected.	Reduce number of applications running on the client computer. Check with the system administrator that there is enough bandwidth available. See also the online help. Check in the AMC control panel applet (MPEG-4 tab) that video processing is not set to Decode only 1 frames . Lower the image resolution.
Image degeneration.	Decrease the GOV length, see the online help for more information.

No images displayed in the Web interface

Problem with AMC (Internet Explorer for Windows only)	To enable the updating of images in Microsoft Internet Explorer for Windows, set your Web browser to allow ActiveX controls. Also, make sure that AXIS Media Control (AMC) component is installed on your workstation.
Installation of additional ActiveX component restricted or prohibited	Configure your AXIS 215 PTZ/AXIS 215 PTZ-E to use a Java applet for updating the images under Live View Config > Layout > Default Viewer for Internet Explorer. See help files for more information.

Video Image Problems

Distorted colors	Problems may occur if the image contains no white color at all, or if the dominant color is not white. In these circumstances, the white balance may incorrectly be based on another visible color in the image, and colors may become distorted. A pale background picture with reddish or blue foreground objects is very symptomatic of this condition. In such cases it is recommended that a fixed white balance setting is selected.
Image too dark or too light	See the help on Video & Image Settings.
Problems uploading own files	There is only limited space available for the upload of your own files. Try deleting one or more existing files, to free up space.
Missing images in uploads	This can occur when trying to use a larger image buffer than is actually available. Try lowering the frame rate or the upload period.
Slow image update	Configuring, e.g. pre-buffers, hi-res images, high frame rate etc will reduce the performance of the AXIS 215 PTZ/AXIS 215 PTZ-E.
Slow performance	Slow performance may be caused by e.g. heavy network traffic, many users with access to unit, low performing client, use of features such as Event handling, Image rotation.

Bad snapshot images

Display incorrectly configured on your workstation	In Display Properties, configure your display to show at least 65000 colors, i.e. at least 16-bit. Using only 16 or 256 colors on your display will produce dithering artifacts in the image.
--	--

Audio problems (AXIS 215 PTZ only)

No audio	Check that: <ul style="list-style-type: none"> • PC sound card, speakers and microphone are correctly connected • the Mute button is not pressed • the volume in and volume out settings are correct • all cabling is connected • the value of the Post Content Length in your proxy server is 1MB or more. You may need to contact your system administrator to do this.
No full-duplex function	Incorrect configuration. Check the setting in the camera's Setup pages. Sound card does not support full-duplex. For information on how to check if your sound card supports full-duplex, please visit www.axis.com and see the support section for Axis camera products.
Poor performance	Too many users/clients connected. Try limiting the number of clients allowed to connect. Low bandwidth. Reduce the Speed setting on the Audio settings page. Setting lower speed will reduce any break-up in the sound, but will also increase the transmission delay. If running in Full-Duplex mode, try switching to Half-Duplex mode.
Whining or screeching sound from speakers (feedback)	Poor positioning of speakers and/or microphone. Relocate the speakers or microphone so that they do not point towards each other, and/or lower the volume.

Mechanical problems

problem with pan, tilt, zoom mechanics	Click the PTZ Status - Test button under System Options > Maintenance to check the pan, tilt, zoom mechanics and camera for errors. If you receive an error message as the result of this test, contact Axis Customer Services at www.axis.com/techsup
--	---

For additional assistance, please contact your reseller or check the product's support pages on the Axis Website at <http://www.axis.com/techsup>

Technical Specifications

Item	Specification
Models	<ul style="list-style-type: none"> • AXIS 215 PTZ - 60Hz • AXIS 215 PTZ - 50Hz • AXIS 215 PTZ-E 60Hz(NTSC) • AXIS 215 PTZ-E 50Hz (PAL)
Image sensor	1/4" sony Interlaced CCD
Lens	F1.6-F2.7 f=3.8-46mm Automatic day/night Autofocus Focus range: 300 mm (wide) or 1000 mm (tele) to infinity
Angle of view	4.4° - 51.6° horizontal
Zoom	12x optical and 4x digital, total 48x
Minimum illumination	Color: 1 lux at 30 IRE, F1.6 B/W: 0.3 lux at 30 IRE, F1.6
Pan Range	+/-170° (360° panning via Auto-flip)
Tilt Range	180°
Max speed	Pan: 180°/sec Tilt: 140°/sec
Video compression	Motion JPEG MPEG-4 Part 2 (ISO/IEC 14496-2), ASP level 0-5, SP level 0-3
Resolutions	4CIF, 2CIFExp, 2CIF, CIF, QCIF Max 704x480 (NTSC) 704x576 (PAL) Min 176x120 (NTSC) 176x144 (PAL)
Frame rate (NTSC/PAL)	Motion JPEG: Up to 30/25 fps in all resolutions MPEG-4 (AXIS 215 PTZ): <ul style="list-style-type: none"> • Up to 30/25 fps at 2CIF/CIF/QCIF • Up to 25/21 fps at 4CIF/2CIFExp MPEG-4 (AXIS 215 PTZ-E) <ul style="list-style-type: none"> • Up to 30/25 (NTSC/PAL) in 2CIF/CIF/QCIF • Up to 26/22 (NTSC/PAL) in 4CIF/2CIFExp
Video streaming	Simultaneous Motion JPEG and MPEG-4 Controllable frame rate and bandwidth Constant and variable bit rate (MPEG-4) 3GPP and ISMA compatible
Image settings	De-interlace (4CIF resolution) Compression levels: 100 Rotation: 0°, 180° Aspect ratio correction Configurable white balance, exposure control, brightness, sharpness and color mode Overlay capabilities: Zone ID, preset ID, time, date, PTZ coordinates, text or image Automatic or manual day/night mode Backlight compensation
Pan/tilt/zoom	Auto-flip E-flip 20 preset positions Sequence mode Control queue Image freeze Supports Windows compatible joysticks Designed for operator control* *Not designed for continuous PTZ movements e.g. Guard tour. For continuous movement, please see Axis network dome offering

AXIS 215 PTZ/AXIS 215 PTZ-E - Technical Specifications

Item	Specification
Shutter time	<ul style="list-style-type: none"> • NTSC: 4/3 - 1/50000 sec • PAL: 8/5 - 1/50000 sec
Audio (AXIS 215 PTZ only)	Two-way (full or half duplex) or one-way G.711 PCM 64kbit/s, G.726 ADPCM 32 or 24 kbit/s Requires external microphone or line in. Mono audio output (line level) connects to PA system or active speaker with built-in amplifier
Security	Multiple user access levels with password protection IP address filtering HTTPS encryption IEEE 802.1X network access control
Users	20 simultaneous unicast users Unlimited users using multicast (MPEG-4)
Alarm and event management	Events triggered by <ul style="list-style-type: none"> • built-in multi-window motion detection • external input (AXIS 215 PTZ only) • audio detection (AXIS 215 PTZ only) • temperature • PTZ preset position • according to schedule Image upload over FTP, email and HTTP Notification over TCP, email, HTTP Pre- and post alarm buffering in Motion JPEG up to 9 MB (approx 4 min of CIF resolution video at 4 fps)
Connectors	AXIS 215 PTZ <ul style="list-style-type: none"> • Ethernet 10BaseT/100BaseTX, RJ-45 • Terminal block for 1 alarm input, 1 output and power out for I/O • Audio line/mic in • Audio line out AXIS 215 PTZ-E <ul style="list-style-type: none"> • RJ-45 for 10BASE-T/100BASE-TX • Pre-installed 5 m (16.4 ft.) Cat-5e cable
Processors and memory	AXIS ETRAX FS 32-bit RISC CPU AXIS ARTPEC-2 video compression chip 32 MB RAM, 8 MB flash Battery backed up real-time clock
Power	12VDC \pm 5%, max 14.5W
Operating conditions	AXIS 215 PTZ <ul style="list-style-type: none"> • 0-45 °C • Humidity 20 - 80% RH (non-condensing) AXIS 215 PTZ-E <ul style="list-style-type: none"> • -20 to 40 °C (-4 to 104 °F) • 2 built-in heaters, 3 built-in fans
Temperature warning	Warning issued when temperature is below or above limits
Installation, management and maintenance	Installation tool on CD and Web-based configuration Configuration backup and restore AXIS Camera Station One for recording. AXIS Camera Management for camera management. Firmware upgrades over HTTP or FTP, firmware available at www.axis.com
Video access from Web browser	Camera live view for up to 20 clients Video recording to file (ASF) Sequence tour for up to 20 Axis video sources Customizable HTML pages
Minimum web browsing requirements	<ul style="list-style-type: none"> • Pentium III CPU 500 MHz or higher, or equivalent AMD, 128 MB RAM, AGP graphics card 32 MB RAM, Direct Draw • Windows XP, 2000, DirectX 9.0 or later • Internet Explorer 6.x or later • For other operating systems and browsers see www.axis.com/techsup

AXIS 215 PTZ/AXIS 215 PTZ-E - Technical Specifications

Item	Specification
System integration support	<ul style="list-style-type: none"> • Open API for application integration, including AXIS VAPIX API*, AXIS Media Control SDK*, event trigger data in video stream • Quality of Service (QoS) Layer 3, DiffServ Model • Watchdog ensures continuous operation, event notifications can be monitored by other systems • Embedded Linux operating system <p>* Available at www.axis.com</p>
Supported protocols	<p>IPv4/v6, HTTP, HTTPS, SSL/TLS*, TCP, QoS, SNMPv1/v2c/v3 (MIB-II), RTSP, RTP, UDP, IGMP, RTCP, SMTP, FTP, ICMP, DHCP, UPnP, Bonjour, ARP, DNS, DynDNS, SOCKS, NTP, IEEE 802.1X. More information on protocol usage available at www.axis.com</p> <p>*This product includes software developed by the Open SSL Project for use in the Open SSL Tool kit (www.openssl.org)</p>
Video management software (not incl.)	<p>AXIS Camera Station – Surveillance application for viewing, recording and archiving up to 25 cameras</p> <p>See www.axis.com/partner/adp_partners.htm for more software applications via partners</p>
Accessories (included)	<ul style="list-style-type: none"> • Indoor power supply AXIS PS-P 12VDC • Hard ceiling and drop ceiling mount kits • Clear and smoked domes • Installation Guide • CD with installation tool, software and User's Manual • MPEG-4 licenses (1 encoder, 1 decoder) • MPEG-4 decoder (Windows) • 1.5" NPT adapter (AXIS 215 PTZ-E only)
Accessories (not included)	<p>AXIS 215 PTZ</p> <ul style="list-style-type: none"> • Outdoor housing solutions • Outdoor power supply • IR illuminators • AXIS 295 Video Surveillance Joystick <p>AXIS 215 PTZ-E</p> <p>Corner mount, pole mount, AXIS 295 Video Surveillance Joystick, AXIS T90A illuminators</p>
Approvals – EMC	<ul style="list-style-type: none"> • EN55024, • EN55022 Class B, • EN61000-3-2, • EN61000-3-3, • EN60950-1, • FCC Part 15 Subpart B Class B, • ICES-003 Class B, • C-tick AS/NZS 3548 • Power supply: UL, CSA, CE
Dimensions (HxWxD) and weight	<p>AXIS 215 PTZ</p> <ul style="list-style-type: none"> • 128 x 153 x 131 mm (5.0" x 6.0" x 5.2") excl. cover • 132 x 162 x 149 mm (5.2" x 6.4" x 5.9") incl. hard ceiling cover • 730g incl. hard ceiling cover • 1260g incl. drop ceiling mounting bracket and cover <p>AXIS 215 PTZ-E</p> <ul style="list-style-type: none"> • 4.8 kg (10.6 lb.) incl. cables, excl. wall bracket and sunshield • 6.1 kg (13.4 lb.) incl. cables, wall bracket and sunshield

File sizes

The AXIS 215 PTZ/AXIS 215 PTZ-E delivers the following file sizes (PAL):

PAL			PAL aspect ratio corrected		
	Resolution	Min-Max (KB)		Resolution	Min-Max (KB)
4CIF	704x576	10 - 300	4CIF	768x576	11 - 330
2CIF expanded	704x576	10 - 250	2CIF expanded	768x576	11 - 270
2CIF	704x288	5 - 150	2CIF	768x288	5.5 - 160
CIF	352x288	2.5 - 80	CIF	384x288	2.7 - 90
QCIF	176x144	1 - 20	QCIF	192x144	1.1 - 22

The AXIS 215 PTZ/AXIS 215 PTZ-E delivers the following file sizes (NTSC):

NTSC			NTSC aspect ratio corrected		
	Resolution	Min-Max (KB)		Resolution	Min-Max (KB)
4CIF	704x480	8 - 250	4CIF	640x480	7 - 230
2CIF expanded	704x480	8 - 200	2CIF expanded	640x480	7 - 180
2CIF	704x240	4 - 125	2CIF	640x240	3.5 - 110
CIF	352x240	2 - 70	CIF	320x240	1.8 - 60
QCIF	176x120	0.8 - 15	QCIF	160x120	0.7 - 14

General performance considerations

When setting up the camera, it is important to consider how various settings and situations will affect performance. Some factors affect the amount of bandwidth (the bit rate) required, others can affect the frame rate, and some will affect both. If the load on the CPU reaches its maximum, this will also affect the frame rate.

The following factors are among the most important to consider:

- High image resolutions and/or lower compression levels result in larger images. Bandwidth affected.
- Access by large numbers of Motion JPEG and/or unicast MPEG-4 clients. Bandwidth affected.
- Simultaneous viewing of different streams (resolution, compression, etc.) by many clients. Frame rate and bandwidth affected.
- Accessing both Motion JPEG and MPEG-4 video streams simultaneously. Frame rate and bandwidth affected.
- Heavy usage of event settings affects the CPU load. Frame rate affected.
- Enabled motion detection. Frame rate and bandwidth affected.
- Heavy network utilization due to poor infrastructure. Bandwidth affected.
- Viewing on poorly performing client PC lowers perceived performance. Frame rate affected.
- Access by large number of audio clients using full-duplex mode. Bandwidth affected.

Optimizing your system

To see the bandwidth and frame rate currently required by the video stream, the AXIS 215 PTZ/AXIS 215 PTZ-E provides a tool that can be used to display these values directly in the video image.

To do this, special format strings are added as part of a text overlay. Simply add **#r** (average frame rate in fps) and/or **#b** (average bandwidth in Kbps) to the overlay.

For detailed instructions, please see the online help for **Video & Image > Overlay Settings**, and the help for **File Naming & Date/Time Formats**.

Overlay Settings

Include overlay image at the coordinates:

Include date Include time

Include text:

Important!

- The figures displayed here are the values as delivered by the camera. If other restrictions are currently in force, (e.g. bandwidth limitation) these values might not correspond to those actually received by the client.
- For Motion JPEG, these values will only be accurate as long as no frame rate limit has been specified.

Frame rates - Motion JPEG

The following test results show the frame rates in frames/second (fps) for Motion JPEG streams from the AXIS 215 PTZ/AXIS 215 PTZ-E, using a compression level of 50%. Note that these values are guidelines only - actual values may vary.

Resolutions	60Hz/50Hz
4CIF	30/25 fps
2CIF expanded	30/25 fps
2CIF	30/25 fps
CIF	30/25 fps
QCIF	30/25 fps

Frame rates - MPEG-4

The following test results show the frame rates in frames/second (fps) for MPEG-4 streams from the AXIS 215 PTZ/AXIS 215 PTZ-E. Note that these values are guidelines only - actual values may vary.

The MPEG-4 test conditions:

- Compression level = 50%
- Video Object Type = Advanced Simple
- GOV structure = IP*

Resolutions	60Hz/50Hz
4CIF	25/21 fps
2CIF expanded	25/21 fps
2CIF	30/25 fps
CIF	30/25 fps
QCIF	30/25 fps

*Note that setting the GOV structure to use "I-frames only" will increase the frame rate.

Bandwidth

As there are many factors affecting bandwidth, it is very difficult to predict the required amounts. The settings that affect bandwidth are:

- the image resolution
- the image compression
- the frame rate
- the MPEG-4 object type
- the MPEG-4 GOV structure
- the audio settings (AXIS 215 PTZ only)

There are also factors in the monitored scene that will affect the bandwidth. These are:

- the amount of motion
- the image's complexity
- the lighting conditions.

For MPEG-4, if there is only limited bandwidth available, and if this is more important than the image quality, using a constant bit rate (CBR) is recommended. Use a variable bit rate (VBR) if the image quality needs to be maintained at a higher level. If supported on the network, consider also using MPEG-4 multicasting, as the bandwidth consumption will be much lower.

Glossary of Terms

ActiveX - A standard that enables software components to interact with one another in a networked environment, regardless of the language(s) used to create them. Web browsers may come into contact with ActiveX controls, ActiveX documents, and ActiveX scripts. ActiveX controls are often downloaded and installed automatically as required.

AF (Autofocus) - A system by which the camera lens automatically focuses on a selected part of the subject.

Angle - The field of view, relative to a standard lens in a 35mm still camera, expressed in degrees, e.g. 30°. For practical purposes, this is the area that a lens can cover, where the angle of view is determined by the focal length of the lens. A wide-angle lens has a short focal length and covers a wider angle of view than standard or telephoto lenses, which have longer focal lengths.

ARP (Address Resolution Protocol) - This protocol is used to associate an IP address to a hardware MAC address. A request is broadcast on the local network to discover the MAC address for an IP address.

ARTPEC (Axis Real Time Picture Encoder) - This chip is used for image compression.

ASIC (Application Specific Integrated Circuit) - A circuit designed for a specific application, as opposed to a general purpose circuit, such as a microprocessor.

Aspect ratio - A ratio of width to height in images. A common aspect ratio used for television screens and computer monitors is 4:3. High-definition television (HDTV) uses an aspect ratio of 9:16.

Autoiris (or DC-Iris) - This special type of iris is electrically controlled by the camera, to automatically regulate the amount of light allowed to enter.

AVI (Audio Video Interleave) - A video format that supports simultaneous playback of audio and video.

Bitmap - A bitmap is a data file representing a rectangular grid of pixels. It defines a display space and color for each pixel (or "bit") in the display space. This type of image is known as a "raster graphic." GIFs and JPEGs are examples of image file types that contain bitmaps.

Because a bitmap uses this fixed raster method, it cannot easily be rescaled without losing definition. Conversely, a vector graphic image uses geometrical shapes to represent the image, and can thus be quickly rescaled.

Bit rate - The bit rate (in kbit/s or Mbit/s) is often referred to as speed, but actually defines the number of bits/time unit and not distance/time unit.

Bluetooth - Bluetooth is an open standard for wireless transmission of voice and data between mobile devices (PCs, handheld computers, telephones and printers).

Bonjour - Also known as zero-configuration networking, Bonjour enables devices to automatically discover each other on a network, without having to enter IP addresses or configure DNS servers. Bonjour is a trademark of Apple Computer, Inc.

Broadband - In network engineering terms, this describes transmission methods where two or more signals share the same carrier. In more popular terminology, broadband is taken to mean high-speed data transmission.

CCD (Charged Coupled Device) - This light-sensitive image device used in many digital cameras is a large integrated circuit that contains hundreds of thousands of photo-sites (pixels) that convert light energy into electronic signals. Its size is measured diagonally and can be 1/4", 1/3", 1/2" or 2/3".

CGI (Common Gateway Interface) - A specification for communication between a web server and other (CGI) programs. For example, a HTML page that contains a form might use a CGI program to process the form data once it is submitted.

CIF (Common Intermediate Format) - CIF refers to the analog video resolutions 352x288 pixels (PAL) and 352x240 pixels (NTSC). See also

Resolution.

Client/Server - Client/server describes the relationship between two computer programs in which one program, the client, makes a service request from another program, the server, which fulfils the request. Typically, multiple client programs share the services of a common server program. A web browser is a client program that requests services (the sending of web pages or files) from a web server.

CMOS (Complementary Metal Oxide Semiconductor) - A CMOS is a widely used type of semiconductor that uses both negative and positive circuits. Since only one of the circuit types is on at any given time, CMOS chips require less power than chips using just one type of transistor. CMOS image sensors also allow processing circuits to be included on the same chip, an advantage not possible with CCD sensors, which are also much more expensive to produce.

Codec - In communications engineering, a codec is usually a coder/decoder. Codecs are used in integrated circuits or chips that convert e.g. analog video and audio signals into a digital format for transmission. The codec also converts received digital signals back into analog format. A codec uses analog-to-digital conversion and digital-to-analog conversion in the same chip.

Codec can also mean compression/decompression, in which case it is generally taken to mean an algorithm or computer program for reducing the size of large files and programs.

Compression - See *Image Compression*.

Contrast - Defines the degree of difference between the lightest and darkest parts of an image or video stream.

DC-Iris - This special type of iris is electrically controlled by the camera, to automatically regulate the amount of light allowed to enter.

DHCP (Dynamic Host Configuration Protocol) - DHCP is a protocol that lets network administrators automate and centrally manage the assignment of Internet Protocol (IP) addresses to network devices in a network.

DHCP uses the concept of a "lease" or amount of time that a given IP address will be valid for a computer. The lease time can vary, depending on how long a user is likely to require the network connection at a particular location.

DHCP also supports static addresses for e.g. computers running web servers, which need a permanent IP address.

DNS (Domain Name System) - DNS is used to locate and translate Internet domain names into IP (Internet Protocol) addresses. A domain name is a meaningful and easy-to-remember name for an Internet address. For example the domain name www.example.com is much easier to remember than 192.0.34.166. The translation tables for domain names are contained in Domain name servers.

Domain Server - Domains can also be used by organizations who wish to centralize the management of their (Windows) computers. Each user within a domain has an account that usually allows them to log in to and use any computer in the domain, although restrictions may also apply. The domain server is the server that authenticates the users on the network.

Duplex - See *Full-duplex*.

Ethernet - Ethernet is the most widely installed local area network technology. An Ethernet LAN typically uses special grades of twisted pair wires. The most commonly installed Ethernet systems are 10BASE-T and 100BASE-T10, which provide transmission speeds up to 10 Mbps and 100 Mbps respectively.

ETRAX (Ethernet Token Ring AXIS) - Axis' own microprocessor.

Factory default settings - These are the settings that originally applied for a device when it was first delivered from the factory. If it should become necessary to reset a device to its factory default settings, this will, for many devices, completely reset any settings that were changed by the user.

Firewall - A firewall works as a barrier between networks, e.g. between a Local Area Network and the Internet. The firewall ensures that only authorized users are allowed to access the one network from the other. A

firewall can be software running on a computer, or it can be a standalone hardware device.

Focal length - Measured in millimeters, the focal length of a camera lens determines the width of the horizontal field of view, which in turn is measured in degrees.

FTP (File Transfer Protocol) - An application protocol that uses the TCP/IP protocols. It is used to exchange files between computers/devices on networks.

Frame - A frame is a complete video image. In the 2:1 interlaced scanning format of the RS-170 and CCIR formats, a frame is made up of two separate fields of 262.5 or 312.5 lines interlaced at 60 or 50 Hz to form a complete frame, which appears at 30 or 25 Hz. In video cameras with a progressive scan, each frame is scanned line-by-line and not interlaced; most are also displayed at 30 and 25 Hz.

Frame rate - The frame rate used to describe the frequency at which a video stream is updated is measured in frames per second (fps). A higher frame rate is advantageous when there is movement in the video stream, as it maintains image quality throughout.

Full-duplex - Transmission of data in two directions simultaneously. In an audio system this would describe e.g. a telephone systems. Half-duplex also provides bi-directional communication, but only in one direction at a time, as in a walkie-talkie system. See also *Simplex*.

Gain - Gain is the amplification factor and the extent to which an analog amplifier boosts the strength of a signal. Amplification factors are usually expressed in terms of power. The decibel (dB) is the most common way of quantifying the gain of an amplifier.

Gateway - A gateway is a point in a network that acts as an entry point to another network. In a corporate network for example, a computer server acting as a gateway often also acts as a proxy server and a firewall server. A gateway is often associated with both a router, which knows where to direct a given packet of data that arrives at the gateway, and a switch, which furnishes the actual path in and out of the gateway for a given packet.

GIF (Graphics Interchange Format) - GIF is one of the most common file formats used for images in web pages. There are two versions of the format, 87a and 89a. Version 89a supports animations, i.e. a short sequence of images within a single GIF file. A GIF89a can also be specified for interlaced presentation.

GOV (Group Of VOPs) - A group of VOPs is the basic unit of an MPEG-4 video stream. The GOV contains different types and numbers of VOPs (I-VOPs, P-VOPs, etc) as determined by the GOV length and GOV structure. See also *VOP*.

GOV length - The GOV length determines the number of images (VOPs) in the GOV structure. See also *GOV* and *VOP*.

GOV structure - The GOV structure describes the composition of an MPEG-4 video stream, as regards the type of images (I-VOPs or P-VOPs) included in the stream, and their internal order. See also *GOV* and *VOP*.

Half-duplex - See *Full-duplex*.

HTML (Hypertext Markup Language) - HTML is the set of "markup" symbols or codes inserted in a file intended for display in web browser. The markup tells the browser how to display the page's words and images for the user.

HTTP (Hypertext Transfer Protocol) - HTTP is the set of rules for exchanging files (text, graphic images, sound, video, and other multimedia files) on the web. The HTTP protocol runs on top of the TCP/IP suite of protocols.

Hub - A (network) hub is used to connect multiple devices to the network. The hub transmits all data to all devices connected to it, whereas a switch will only transmit the data to the device it is specifically intended for.

IEEE 802.11 - A family of standards for wireless LANs. The 802.11 standard supports 1 or 2 Mbit/s transmission on the 2.4 GHz band. IEEE 802.11b specifies an 11 Mbit/s data rate on the 2.4 GHz band, while 802.11a allows up to 54 Mbit/s on the 5 GHz band.

Image compression - Image compression minimizes the file size (in

bytes) of an image. Two of the most common compressed image formats are JPEG and GIF.

Interlacing - Interlaced video is video captured at 50 pictures (known as fields) per second, of which every 2 consecutive fields (at half height) are then combined into 1 frame. Interlacing was developed many years ago for the analog TV world and is still used widely today. It provides good results when viewing motion in standard TV pictures, although there is always some degree of distortion in the image.

To view interlaced video on e.g. a computer monitor, the video must first be de-interlaced, to produce progressive video, which consists of complete images, one after the other, at 25 frames per second. See also *Progressive scan*.

IP (Internet Protocol) - The Internet Protocol is a method transmitting data over a network. Data to be sent is divided into individual and completely independent "packets." Each computer (or host) on the Internet has at least one address that uniquely identifies it from all others, and each data packet contains both the sender's address and the receiver's address.

The Internet Protocol ensures that the data packets all arrive at the intended address. As IP is a connectionless protocol, which means that there is no established connection between the communication end-points, packets can be sent via different routes and do not need to arrive at the destination in the correct order.

Once the data packets have arrived at the correct destination, another protocol - Transmission Control Protocol (TCP) - puts them in the right order. See also *TCP*.

IP Address - An IP address is simply an address on an IP network used by a computer/device connected to that network. IP addresses allow all the connected computers/devices to find each other and to pass data back and forth.

To avoid conflicts, each IP address on any given network must be unique. An IP address can be assigned as fixed, so that it does not change, or it can be assigned dynamically (and automatically) by DHCP.

An IP address consists of four groups (or quads) of decimal digits separated by periods, e.g. 130.5.5.25. Different parts of the address represent different things. Some part will represent the network number or address, and some other part will represent the local machine address.

See also *IP (Internet Protocol)*.

I-VOP - See *VOP*.

JPEG (Joint Photographic Experts Group) - Together with the GIF file format, JPEG is an image file type commonly used on the web. A JPEG image is a bitmap, and usually has the file suffix '.jpg' or '.jpeg.' When creating a JPEG image, it is possible to configure the level of compression to use. As the lowest compression (i.e. the highest quality) results in the largest file, there is a trade-off between image quality and file size.

kbit/s (kilobits per second) - A measure of the bit rate, i.e. the rate at which bits are passing a given point. See also *Bit rate*.

LAN (Local Area Network) - A LAN is a group of computers and associated devices that typically share common resources within a limited geographical area.

Linux - Linux is an open source operating system within the Unix family. Because of its robustness and availability, Linux has won popularity in the open source community and among commercial application developers.

MAC address (Media Access Control address) - A MAC address is a unique identifier associated with a piece of networking equipment, or more specifically, its interface with the network. For example, the network card in a computer has its own MAC address.

Manual iris - This is the opposite to an auto iris, i.e. the camera iris must be adjusted manually to regulate the amount of light allowed to reach the image sensor.

Mbit/s (Megabits per second) - A measure of the bit rate, i.e. the rate at which bits are passing a given point. Commonly used to give the "speed" of a network. A LAN might run at 10 or 100 Mbit/s. See also *Bit rate*.

Monitor - A monitor is very similar to a standard television set, but lacks the electronics to pick up regular television signals.

Motion JPEG - Motion JPEG is a simple compression/decompression technique for networked video. Latency is low and image quality is guaranteed, regardless of movement or complexity of the image. Image quality is controlled by adjusting the compression level, which in turn provides control over the file size, and thereby the bit rate.

High-quality individual images from the Motion JPEG stream are easily extracted. See also JPEG.

Megapixel - See *Pixel*.

MPEG (Moving Picture Experts Group) - The Moving Picture Experts Group develops standards for digital video and audio compression. It operates under the auspices of the International Organization for Standardization (ISO). The MPEG standards are an evolving series, each designed for a different purpose.

MPEG-2 - MPEG-2 is the designation for a group of audio and video coding standards, and is typically used to encode audio and video for broadcast signals, including digital satellite and Cable TV. MPEG-2, with some modifications, is also the coding format used by standard commercial DVD movies.

MPEG-4 - MPEG-4 is a group of audio and video coding standards and related technology. The primary uses for the MPEG-4 standard are web (streaming media) and CD distribution, conversational (videophone), and broadcast television.

Most of the features included in MPEG-4 are left to individual developers to decide whether to implement them or not. This means that there are probably no complete implementations of the entire MPEG-4 set of standards. To deal with this, the standard includes the concept of "profiles" and "levels", allowing a specific set of capabilities to be defined in a manner appropriate for a subset of applications.

Multicast - Bandwidth-conserving technology that reduces bandwidth usage by simultaneously delivering a single stream of information to multiple network recipients.

Multiplexer - A multiplexer is a high-speed switch that provides full-screen images from up to 16 analog cameras. Multiplexers can playback everything that happened on any one camera with no interference from the other cameras on the system.

Network connectivity - The physical (wired or wireless) and logical (protocol) connection of a computer network or an individual device to a network, such as the Internet or a LAN.

NTSC (National Television System Committee) - NTSC is the television and video standard in the United States. NTSC delivers 525 lines at 60 half-frames/second.

NWay is a telecommunications protocol used to automatically negotiate the highest available transmission speed between network devices. The NWay protocol is also known as auto-negotiation or auto-sensing.

OEM (Original Equipment Manufacturer) - This is a designation for companies that manufacture equipment which is then marketed and sold to other companies under their own names.

PAL (Phase Alternating Line) - PAL is the dominant television standard in Europe. PAL delivers 625 lines at 50 half-frames/second.

PEM (Privacy Enhanced Mail) - An early standard for securing electronic mail. The PEM-format is often used for representing an HTTPS certificate or certificate request.

Ping - Ping is a basic network program used diagnostically to check the status of a network host or device. Ping can be used to see if a particular network address (IP address or host name) is occupied or not, or if the host at that address is responding normally. Ping can be run from e.g. the Windows Command prompt or the command line in Unix.

Pixel - A pixel is one of the many tiny dots that make up a digital image. The color and intensity of each pixel represents a tiny area of the complete image.

PoE (Power over Ethernet) - Power over Ethernet provides power to a network device via the same cable as used for the network connection.

This is very useful for IP-Surveillance and remote monitoring applications in places where it may be too impractical or expensive to power the device from a power outlet.

PPP (Point-to-Point Protocol) - A protocol that uses a serial interface for communication between two network devices. For example, a PC connected by a phone line to a server.

PPTP (Point-to-Point Tunnelling Protocol) - A protocol (set of communication rules) that allows corporations to extend their own corporate network through private "tunnels" over the public Internet. In this way a corporation can effectively use a WAN (Wide Area Network) as a large single LAN (Local Area Network). This kind of interconnection is known as a virtual private network (VPN).

Pre/post alarm images - The images from immediately before and after an alarm. These images are stored in a buffer for later retrieval.

Progressive scan - Progressive scan, as opposed to interlaced video, scans the entire picture, line by line every sixteenth of a second. In other words, captured images are not split into separate fields as in interlaced scanning.

Computer monitors do not need interlace to show the picture on the screen, but instead show them progressively, on one line at a time in perfect order, i.e. 1, 2, 3, 4, 5, 6, 7 etc., so there is virtually no "flickering" effect. In a surveillance application, this can be critical when viewing detail within a moving image, such as a person running. A high-quality monitor is required to get the best from progressive scan. See also *Interlacing*.

Protocol - A special set of rules governing how two entities will communicate. Protocols are found at many levels of communication, and there are hardware protocols and software protocols.

Proxy server - In an organization that uses the Internet, a proxy server acts as an intermediary between a workstation user and the Internet. This provides security, administrative control, and a caching service. Any proxy server associated with a gateway server, or part of a gateway server, effectively separates the organization's network from the outside network and the local firewall. It is the firewall server that protects the network against outside intrusion.

A proxy server receives requests for Internet services (such as web page requests) from many users. If the proxy server is also a cache server, it looks in its local cache of previously downloaded web pages. If it finds the page, it is returned to the user without forwarding the request to the Internet. If the page is not in the cache, the proxy server, acting as a client on behalf of the user, uses one of its own IP addresses to request the page from another server over the Internet. When the requested page is returned, the proxy server forwards it to the user that originally requested it.

PTZ - Pan, tilt and zoom.

P-VOP - See *VOP*.

Resolution - Image resolution is a measure of how much detail a digital image can hold: the greater the resolution, the greater the level of detail. Resolution can be specified as the number of pixel-columns (width) by the number of pixel-rows (height), e.g. 320x240.

Alternatively, the total number of pixels (usually in megapixels) in the image can be used. In analog systems it is also common to use other format designations, such as CIF, QCIF, 4CIF, etc.

RTCP (Real-Time Control Protocol) - RTCP provides support for real-time conferencing of groups of any size within an intranet. This support includes source identification and support for gateways like audio and video bridges as well as multicast-to-unicast translators.

RTCP offers quality-of-service feedback from receivers to the multicast group as well as support for the synchronization of different media streams.

RTP (Real-Time Transport Protocol) - RTP is an Internet protocol for the transport of real-time data, e.g. audio and video. It can be used for media-on-demand as well as interactive services such as Internet telephony.

RTSP (Real Time Streaming Protocol) - RTSP is a control protocol, and

a starting point for negotiating transports such as RTP, multicast and Unicast, and for negotiating codecs.

RTSP can be considered a "remote control" for controlling the media stream delivered by a media server. RTSP servers typically use RTP as the protocol for the actual transport of audio/video data.

Router - A device that determines the next network point to which a packet should be forwarded on its way to its final destination. A router creates and/or maintains a special routing table that stores information on how best to reach certain destinations. A router is sometimes included as part of a network switch. See also *switch*.

Server - In general, a server is a computer program that provides services to other computer programs in the same or other computers. A computer running a server program is also frequently referred to as a server. In practice, the server may contain any number of server and client programs. A web server is the computer program that supplies the requested HTML pages or files to the client (browser).

Sharpness - This is the control of fine detail within a picture. This feature was originally introduced into color TV sets that used notch filter decoders. This filter took away all high frequency detail in the black and white region of the picture. The sharpness control attempted to put some of that detail back in the picture. Sharpness controls are mostly superfluous in today's high-end TVs. The only logical requirement for it nowadays is on a VHS machine.

Simplex - In simplex operation, a network cable or communications channel can only send information in one direction.

SMTP (Simple Mail Transfer Protocol) - SMTP is used for sending and receiving e-mail. However, as it is "simple," it is limited in its ability to queue messages at the receiving end, and is usually used with one of two other protocols, POP3 or IMAP. These other protocols allow the user to save messages in a server mailbox and download them periodically from the server.

SMTP authentication is an extension of SMTP, whereby the client is required to log into the mail server before or during the sending of email. It can be used to allow legitimate users to send email while denying the service to unauthorized users, such as spammers.

SNMP (Simple Network Management Protocol) - SNMP forms part of the Internet Protocol suite, as defined by the Internet Engineering Task Force. The protocol can support monitoring of network-attached devices for any conditions that warrant administrative attention.

Sockets - Sockets are a method for communication between a client program and a server program over a network. A socket is defined as "the endpoint in a connection." Sockets are created and used with a set of programming requests or "function calls" sometimes called the sockets application programming interface (API).

SSL/TSL (Secure Socket Layer/Transport Layer Security)

These two protocols (SSL is succeeded by TSL) are cryptographic protocols that provide secure communication on a network. SSL is commonly used over HTTP to form HTTPS, as used e.g. on the Internet for electronic financial transactions. SSL uses public key certificates to verify the identity of the server.

Subnet/subnet mask - A subnet is an identifiably separate part of an organization's network. Typically, a subnet may represent all the machines at one geographic location, in one building, or on the same local area network (LAN). Having an organization's network divided into subnets allows it to be connected to the Internet with a single shared network address.

The subnet mask is the part of the IP address that tells a network router how to find the subnet that the data packet should be delivered to. Using a subnet mask saves the router having to handle the entire 32-bit IP address; it simply looks at the bits selected by the mask.

Switch - A switch is a network device that connects network segments together, and which selects a path for sending a unit of data to its next destination. In general, a switch is a simpler and faster mechanism than a router, which requires knowledge about the network and how to determine the route. Some switches include the router function. See also *Router*.

TCP (Transmission Control Protocol) - TCP is used along with the Internet Protocol (IP) to transmit data as packets between computers over the network. While IP takes care of the actual packet delivery, TCP keeps track of the individual packets that the communication (e.g. requested a web page file) is divided into, and, when all packets have arrived at their destination, it reassembles them to re-form the complete file.

TCP is a connection-oriented protocol, which means that a connection is established between the two end-points and is maintained until the data has been successfully exchanged between the communicating applications.

Telnet - Telnet is a simple method with which to access another network device, e.g. a computer. The HTTP protocol and the FTP protocols allow you to request specific files from remote computers, but do not allow you logon as a user of that computer. With Telnet, you log on as a regular user with whatever privileges you may have been granted for specific applications and data residing on that computer.

TVL (TV Lines) - A method of defining resolutions in analog video.

UDP (User Datagram Protocol) - UDP is a communications protocol that offers limited service for exchanging data in a network that uses the Internet Protocol (IP). UDP is an alternative to the Transmission Control Protocol (TCP). The advantage of UDP is that it is not required to deliver all data and may drop network packets when there is e.g. network congestion. This is suitable for live video, as there is no point in re-transmitting old information that will not be displayed anyway.

Unicast - Communication between a single sender and a single receiver over a network. A new connection is established for each new user.

URL (Uniform Resource Locator) - An "address" on the network.

USB - (Universal Serial Bus) A plug-and-play interface between a computer and peripheral devices, e.g. scanners, printers, etc.

Varifocal lens - A varifocal lens provides a wide range of focal lengths, as opposed to a lens with a fixed focal length, which only provides one.

VPN (Virtual Private Network) - This creates a secure "tunnel" between the points within the VPN. Only devices with the correct "key" will be able to work within the VPN. The VPN network can be within a company LAN (Local Area Network), but different sites can also be connected over the Internet in a secure way. One common use for VPN is for connecting a remote computer to the corporate network, via e.g. a direct phone line or via the Internet.

VOP (Video Object Plane) - A VOP is an image frame in an MPEG-4 video stream. There are several types of VOP:

- An I-VOP is complete image frame.

- A P-VOP codes the differences between images, as long as it is more efficient to do so. Otherwise it codes the whole image, which may also be a completely new image.

WAN (Wide-Area-Network) - Similar to a LAN, but on a larger geographical scale.

WLAN (Wireless LAN) - A wireless LAN is a wireless local area network that uses radio waves as its carrier: where the network connections for end-users are wireless. The main network structure usually uses cables.

Web server - A Web server is a program, which allows Web browsers to retrieve files from computers connected to the Internet. The Web server listens for requests from Web browsers and upon receiving a request for a file sends it back to the browser.

The primary function of a Web server is to serve pages to other remote computers; consequently, it needs to be installed on a computer that is permanently connected to the Internet. It also controls access to the server whilst monitoring and logging server access statistics.

WEP (Wireless Equivalent Privacy) - A wireless security protocol, specified in the IEEE 802.11 standard, which is designed to provide a wireless local area network (WLAN) with a level of security and privacy comparable to that usually expected of a wired LAN. Security is at two different levels; 40-bit and 128-bit encryption. The higher the bit number, the more secure the encryption.

WINS (Windows Internet Naming Service) - Part of the Microsoft Windows NT Server, WINS manages the association of workstation names and locations with IP addresses, without the user or administrator having to be involved in each configuration change.

WPA-PSK (Wi-Fi Protected Access - Pre-Shared Key) - This wireless encryption method uses a pre-shared key (PSK) for key management. Keys can usually be entered as manual hex values, as hexadecimal characters, or as a Passphrase. WPA-PSK provides a greater degree of security than WEP.

Zoom lens - A zoom lens can be moved (zoomed) to enlarge the view of an object to show more detail.

Index

4CIF de-interlacing 12
802.1x 28

A

Accessing the video stream 10
Action 23
Action Buttons 19
Active/Inactive 19
Administrator 27
Administrators 11
Advanced Simple profile 8
Alarm 23, 25, 35
AMC 6, 9
ARP/Ping 29
Audio 15
Audio input 15
Audio mode 15
Audio output 16
Auxiliary Power 35
AXIS Media Control 15
AXIS VAPIX API 19

B

Backup 33
Bandwidth 8, 45
Bit rate 8
Bonjour 32
Brightness 12
Buffer Size 25
Buffers 25

C

CA servers 28
CGI links 19
Color Setting 12
Compression 12
Constant bit rate 8
Control Panel 6

D

Date & Time 29
Default 33
Default Video Format 19
Default Viewer 19
De-interlacing 12
DNS Configuration 30
DNS Server 30
Domain Name 30
DSCP 31

E

Event 23

Event Servers 23
Event Types 24

F

Factory Default 34
File Sizes (NTSC) 44
File Sizes (PAL) 44
Frame rates 12, 45
FTP Server 23
Full duplex 15

H

Half duplex 15
Host Name 30
HTML Examples 20
HTTP 30
HTTP Server 23
HTTPS 27

I

Include windows 26
Input 35
IR light 6

L

Live View 11
Live View Config 18
Logs & Reports 34

M

Motion Detection 25, 35
Motion JPEG 8
MPEG-4 8, 12, 14, 32
MPEG-4 protocols 9
Multicasting 9

N

NAT Traversal 30
Network 29
New Server Time 29
NTP Configuration 30
NTP Server 29

O

Operator 27
Other MPEG-4 clients 10
Output 35
Output Buttons 19
Overlay Image 13
Overlay Settings 12
Own Home Page 19
Own web files 18

P

Pan/Tilt/Zoom Control Queue 7
 Password 4
 Pinout - I/O connectors 35
 Port Status 26
 Ports & Devices 32
 Post-trigger Buffer 25
 Pre-trigger Buffer 25
 PTZ Commands 19
 Pulse 5, 19
 Push to talk 15

Upgrade Server 33
 UPnP 30, 32
 User 27
 User Defined Links 19
 User List 27

Q

QoS 31

R

RADIUS 28
 Referrals 27
 Reset Button 34
 Resolution 12
 Restart 33
 Restore 33
 Rotate Image 12
 RTP 9
 RTP (multicast) 32
 RTSP 9

V

VAPIX API 19
 Variable bit rate 8
 Video Stream 12
 Viewer settings 20

S

Scheduled Event 23, 25
 Security 27
 Security/Users 27
 Sequence Mode 5
 Services 29
 Setup 11
 Shortcuts 6
 Simple profile 8
 SMTP 31
 Snapshot 5
 SNMP 32
 SOCKS 31
 Streaming MPEG-4 9
 Support 34
 System Options 27
 System Overview 34

T

TCP Server 23
 Time Mode 29
 Triggered Event 23, 24
 Troubleshooting 37

U

UDP 9
 Unicasting 9
 Unit connectors 35

Free Manuals Download Website

<http://myh66.com>

<http://usermanuals.us>

<http://www.somanuals.com>

<http://www.4manuals.cc>

<http://www.manual-lib.com>

<http://www.404manual.com>

<http://www.luxmanual.com>

<http://aubethermostatmanual.com>

Golf course search by state

<http://golfingnear.com>

Email search by domain

<http://emailbydomain.com>

Auto manuals search

<http://auto.somanuals.com>

TV manuals search

<http://tv.somanuals.com>