

USER MANUAL

AXIS P5414-E PTZ Dome Network Camera



About this Document

This manual is intended for administrators and users of the AXIS P5414-E PTZ Dome Network Camera, and is applicable to firmware 5.55 and later. It includes instructions for using and managing the product on your network. Previous experience of networking will be of use when using this product. Some knowledge of UNIX or Linux-based systems may also be beneficial, for developing shell scripts and applications. Later versions of this document will be posted to the Axis website, as required. See also the product's online help, available via the web-based interface.

Legal Considerations

Video and audio surveillance can be regulated by laws that vary from country to country. Check the laws in your local region before using this product for surveillance purposes.

This product includes one (1) H.264 decoder license and one (1) AAC decoder license. To purchase further licenses, contact your reseller.

Liability

Every care has been taken in the preparation of this document. Please inform your local Axis office of any inaccuracies or omissions. Axis Communications AB cannot be held responsible for any technical or typographical errors and reserves the right to make changes to the product and manuals without prior notice. Axis Communications AB makes no warranty of any kind with regard to the material contained within this document, including, but not limited to, the implied warranties of merchantability and fitness for a particular purpose. Axis Communications AB shall not be liable nor responsible for incidental or consequential damages in connection with the furnishing, performance or use of this material. This product is only to be used for its intended purpose.

Intellectual Property Rights

Axis AB has intellectual property rights relating to technology embodied in the product described in this document. In particular, and without limitation, these intellectual property rights may include one or more of the patents listed at <http://www.axis.com/patent.htm> and one or more additional patents or pending patent applications in the US and other countries.

This product contains licensed third-party software. See the menu item "About" in the product's user interface for more information.

This product contains source code copyright Apple Computer, Inc., under the terms of Apple Public Source License 2.0 (see <http://www.opensource.apple.com/aps/>). The source code is available from <http://developer.apple.com/darwin/projects/bonjour/>

Equipment Modifications

This equipment must be installed and used in strict accordance with the instructions given in the user documentation. This equipment contains no user-serviceable components. Unauthorized equipment changes or modifications will invalidate all applicable regulatory certifications and approvals.

Trademark Acknowledgments

AXIS COMMUNICATIONS, AXIS, ETRAX, ARTPEC and VAPIX are registered trademarks or trademark applications of Axis AB in various jurisdictions. All other company names and products are trademarks or registered trademarks of their respective companies.

Apple, Boa, Apache, Bonjour, Ethernet, Internet Explorer, Linux, Microsoft, Mozilla, Real, SMPTE, QuickTime, UNIX, Windows, Windows Vista and WWW are registered trademarks of the respective holders. Java and all Java-based trademarks and logos are trademarks or registered trademarks of Oracle and/or its affiliates. UPnP™ is a certification mark of the UPnP™ Implementers Corporation.

SD, SDHC and SDXC are trademarks or registered trademarks of SD-3C, LLC in the United States, other countries or both. Also, miniSD, microSD, miniSDHC, microSDHC, microSDXC are all trademarks or registered trademarks of SD-3C, LLC in the United States, other countries or both.

Regulatory Information

Europe

 This product complies with the applicable CE marking directives and harmonized standards:

- Electromagnetic Compatibility (EMC) Directive 2004/108/EC. See *Electromagnetic Compatibility (EMC)*, on page 2.
- Low Voltage (LVD) Directive 2006/95/EC. See *Safety*, on page 2.
- Restrictions of Hazardous Substances (RoHS) Directive 2011/65/EU. See *Disposal and Recycling*, on page 2.

A copy of the original declaration of conformity may be obtained from Axis Communications AB. See *Contact Information*, on page 3.

Electromagnetic Compatibility (EMC)

This equipment has been designed and tested to fulfill applicable standards for:

- Radio frequency emission when installed according to the instructions and used in its intended environment.
- Immunity to electrical and electromagnetic phenomena when installed according to the instructions and used in its intended environment.

USA

This equipment has been tested using a shielded network cable (STP) and found to comply with the limits for a Class B digital device, pursuant to part 15 of the FCC Rules. These limits are designed to provide reasonable protection against harmful interference in a residential installation. This equipment generates, uses and can radiate radio frequency energy and, if not installed and used in accordance with the instructions, may cause harmful interference to radio communications. However, there is no guarantee that interference will not occur in a particular installation. If this equipment does cause harmful interference to radio or television reception, which can be determined by turning the equipment off and on, the user is encouraged to try to correct the interference by one or more of the following measures:

- Reorient or relocate the receiving antenna.
- Increase the separation between the equipment and receiver.
- Connect the equipment into an outlet on a circuit different from that to which the receiver is connected.
- Consult the dealer or an experienced radio/TV technician for help.

Canada

This Class B digital apparatus complies with Canadian ICES-003.

Europe

This digital equipment fulfills the requirements for RF emission according to the Class B limit of EN 55022.

This product fulfills the requirements for immunity according to EN 61000-6-1 residential, commercial and light-industrial environments.

This product fulfills the requirements for immunity according to EN 61000-6-2 industrial environments.

This product fulfills the requirements for immunity according to EN 55024 office and commercial environments

Australia/New Zealand

This digital equipment fulfills the requirements for RF emission according to the Class B limit of AS/NZS CISPR 22.

Japan

この装置は、クラスB情報技術装置です。この装置は、家庭環境で使用することを目的としていますが、この装置がラジオやテレビジョン受信機に近接して使用されると、受信障害を引き起こすことがあります。取扱説明書に従って正しい取り扱いをして下さい。

Korea

이 기기는 가정용(B급) 전자파적합기기로서 주로 가정에서 사용하는 것을 목적으로 하며, 모든 지역에서 사용할 수 있습니다.

Safety

This product complies with IEC/EN/UL 60950-1 and IEC/EN/UL 60950-22, Safety of Information Technology Equipment.

The power supply used with this product shall fulfill the requirements for Safety Extra Low Voltage (SELV) and Limited Power Source (LPS) according to IEC/EN/UL 60950-1.

Disposal and Recycling

When this product has reached the end of its useful life, dispose of it according to local laws and regulations. For information about your nearest designated collection point, contact your local authority responsible for waste disposal. In accordance with local legislation, penalties may be applicable for incorrect disposal of this waste.

Europe



This symbol means that the product shall not be disposed of together with household or commercial waste. Directive 2012/19/EU on waste electrical and electronic equipment (WEEE) is applicable in the European Union member states. To prevent potential harm to human health and the environment, the product must be disposed of in an approved and environmentally safe recycling process. For information about your nearest designated collection point, contact your local authority responsible for waste disposal. Businesses should contact the product supplier for information about how to dispose of this product correctly.

This product complies with the requirements of Directive 2011/65/EU on the restriction of the use of certain hazardous substances in electrical and electronic equipment (RoHS).

China



This product complies with the requirements of the legislative act Administration on the Control of Pollution Caused by Electronic Information Products (ACPEIP).

Contact Information

Axis Communications AB
Emdalavägen 14
223 69 Lund
Sweden

Tel: +46 46 272 18 00

Fax: +46 46 13 61 30

www.axis.com

Support

Should you require any technical assistance, please contact your Axis reseller. If your questions cannot be answered immediately, your reseller will forward your queries through the appropriate channels to ensure a rapid response. If you are connected to the Internet, you can:

- download user documentation and software updates
- find answers to resolved problems in the FAQ database. Search by product, category, or phrase
- report problems to Axis support staff by logging in to your private support area
- chat with Axis support staff (selected countries only)
- visit Axis Support at www.axis.com/techsup/

Learn More!

Visit Axis learning center www.axis.com/academy/ for useful trainings, webinars, tutorials and guides.

AXIS P5414–E PTZ Dome Network Camera

Table of Contents

Hardware Overview	6
Connectors and Buttons	6
LED Indicators	7
Accessing the Product	8
Access from a Browser	8
Access from the Internet	9
Set the Root Password	9
The Live View Page	9
Media Streams	13
How to Stream H.264	13
MJPEG	13
AXIS Media Control (AMC)	13
Alternative Methods of Accessing the Video Stream	14
Accessing Audio Streams	15
Setting Up the Product	16
Basic Setup	16
Video and Audio	17
Video Stream	17
Stream Profiles	18
Camera Settings	18
Overlay	20
Privacy Mask	22
Audio Settings	22
Audio Clips	23
Live View Config	24
PTZ (Pan Tilt Zoom)	27
Preset Positions	27
Gatekeeper	28
Guard Tour	28
OSDI Zones	28
Advanced	29
Control Queue	29
Detectors	31
Motion Detection	31
Audio Detection	32
Applications	33
Application Licenses	33
Install Application	33
Application Considerations	33
Events	35
Setting Up an Action Rule	36
Recipients	37
Schedules	38
Recurrences	38
Recordings	40
Recording List	40
Continuous Recording	40
Languages	41
System Options	42
Security	42
Date & Time	44
Network	45
Storage	50
Ports & Devices	51
Maintenance	51
Support	52
Advanced	52
Reset to Factory Default Settings	53
Repainting the Camera	54
Troubleshooting	55
Checking the Firmware	55

AXIS P5414–E PTZ Dome Network Camera

Table of Contents

Upgrading the Firmware	55
Symptoms, Possible Causes and Remedial Actions	56
Technical Specifications	59
Connectors	61
Performance Considerations	63

AXIS P5414-E PTZ Dome Network Camera

Hardware Overview

Hardware Overview

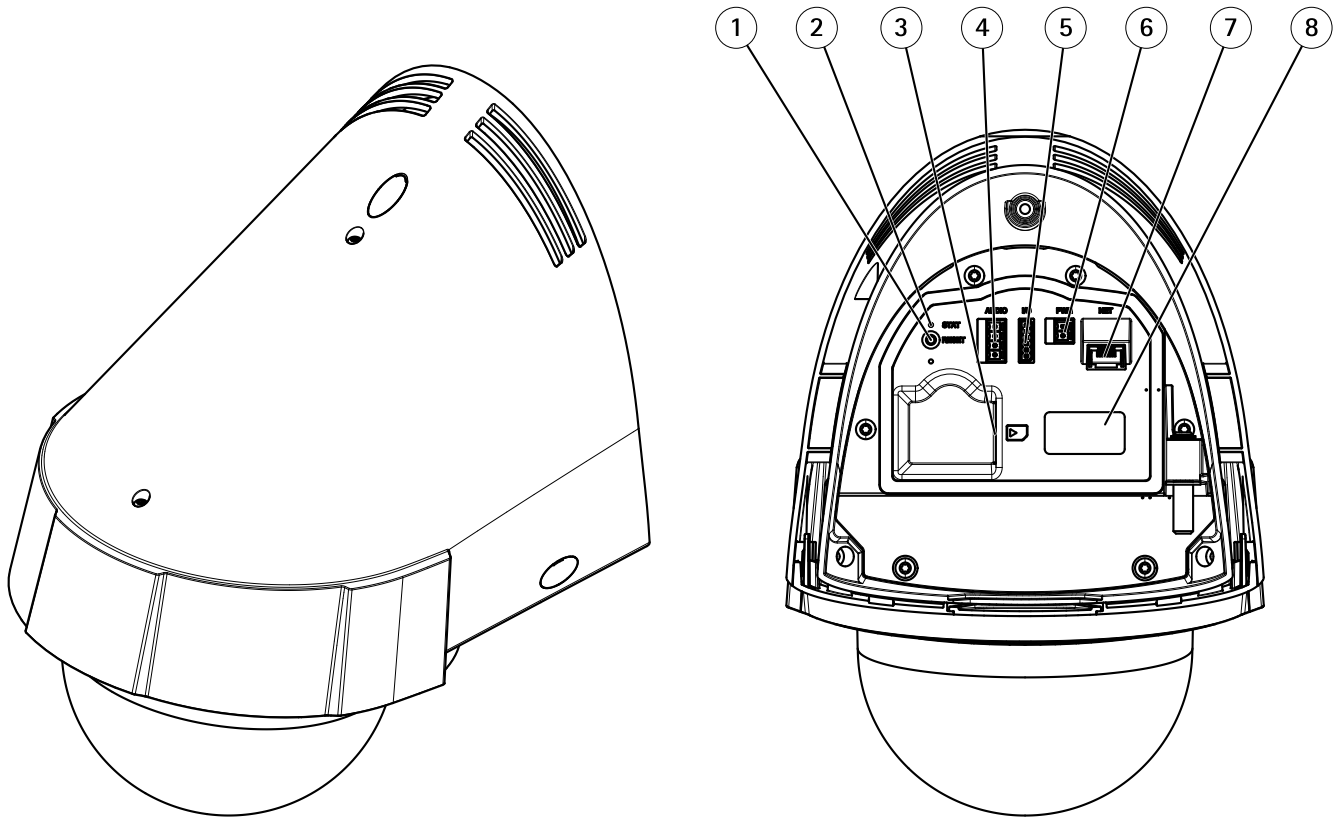

- 1 Control button
- 2 Status LED indicator
- 3 SD memory card slot
- 4 Audio connector
- 5 I/O connector
- 6 Power connector
- 7 Network connector (PoE+)
- 8 Part number (P/N) & Serial number (S/N)

Connectors and Buttons

For technical specifications, see *page 59*.

Network Connector

RJ45 Ethernet connector. Supports Power over Ethernet Plus (PoE+).

NOTICE

The product shall be connected using a shielded network cable (STP) or an optical fiber cable. All cables connecting the product to the network shall be intended for their specific use. Make sure that the network devices are installed in accordance with the manufacturer's instructions. For information about regulatory requirements, see *Electromagnetic Compatibility (EMC), on page 2*.

AXIS P5414–E PTZ Dome Network Camera

Hardware Overview

I/O Connector

Use in applications for e.g. motion detection, event triggering, time lapse recording and alarm notifications. In addition to an auxiliary power and a GND pin, the I/O terminal connector provides the interface to:

- **Digital output** – For connecting external devices such as relays and LEDs. Connected devices can be activated by the VAPIX® Application Programming Interface, output buttons on the Live View page or by an Action Rule. The output will show as active (shown under **System Options > Ports & Devices**) if the alarm device is activated.
- **Digital input** – An alarm input for connecting devices that can toggle between an open and closed circuit, for example: PIRs, door/window contacts, glass break detectors, etc. When a signal is received the state changes and the input becomes active (shown under **System Options > Ports & Devices**).

Power Connector

2-pin terminal block for power input. Use a Safety Extra Low Voltage (SELV) compliant limited power source (LPS) with either a rated output power limited to ≤ 100 W or a rated output current limited to ≤ 5 A.

Audio Connector

4-pin terminal block for audio input and output.

SD Card Slot

An SD card (not included) can be used for local recording with removable storage. For more information, see *Technical Specifications*.

NOTICE

To prevent corruption of recordings, the SD card should be unmounted before removal. To unmount, go to **Setup > System Options > Storage > SD Card** and click **Unmount**.

Control Button

The control button is used for:

- Resetting the product to factory default settings. See *page 53*.
- Connecting to an AXIS Video Hosting System service. See *page 46*. To connect, press and hold the button for about 1 second until the Status LED flashes green.
- Connecting to AXIS Internet Dynamic DNS Service. See *page 46*. To connect, press and hold the button for about 3 seconds.

LED Indicators

LED	Color	Indication
Status	Unlit	Connection and normal operation
	Amber	Steady during startup. Flashes during firmware upgrade.
	Amber/red	Flashes amber/red if network connection is unavailable or lost.
	Red	Flashes red for firmware upgrade failure.
	Green	Shows steady green for 10 seconds for normal operation after restart.

AXIS P5414-E PTZ Dome Network Camera

Accessing the Product

Accessing the Product

To install the Axis product, refer to the Installation Guide supplied with the product.

The product can be used with most operating systems and browsers. The recommended browsers are Internet Explorer with Windows, Safari with Macintosh and Firefox with other operating systems. See *Technical Specifications, on page 59*.

To view streaming video in Internet Explorer, allow installation of AXIS Media Control (AMC) when prompted.

Note

- QuickTime™ is also supported for viewing H.264 streams and for audio.
- If your computer restricts the use of additional software components, the product can be configured to use a Java applet for viewing Motion JPEG.

Access from a Browser

1. Start a browser (Internet Explorer, Firefox, Safari).
2. Enter the IP address or host name of the Axis product in the browser's Location/Address field. To access the product from a Macintosh computer (Mac OS X), click on the Bonjour tab and select the product from the drop-down list.

If you do not know the IP address, use AXIS IP Utility to locate the product on the network. For information about how to discover and assign an IP address, see the Installation and Management Software CD or the document *Assign an IP Address and Access the Video Stream* on Axis Support web at www.axis.com/techsup

3. Enter your user name and password. If this is the first time the product is accessed, the root password must first be configured. For instructions, see *Set the Root Password, on page 9*.
4. The product's Live View page appears in your browser.

Note

The controls and layout of the Live View page may have been customized to meet specific installation requirements and user preferences. Consequently, some of the examples and functions featured here may differ from those displayed in your own Live View page.

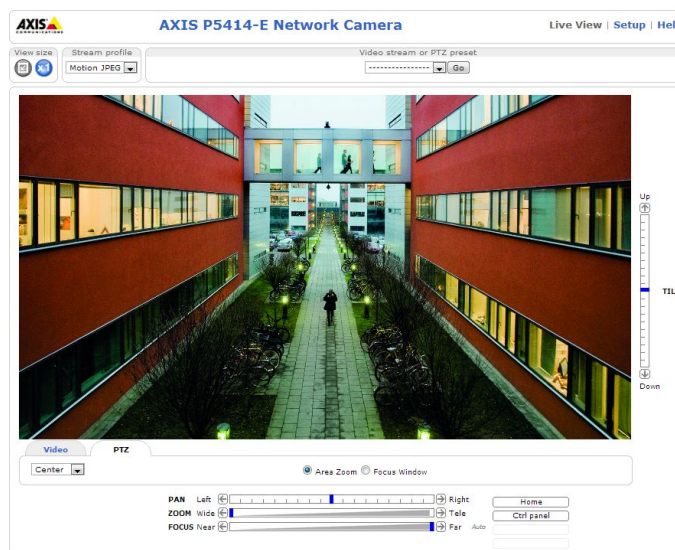

AXIS P5414–E PTZ Dome Network Camera

Accessing the Product

Access from the Internet

Once connected, the Axis product is accessible on your local network (LAN). To access the product from the Internet you must configure your network router to allow incoming data traffic to the product. To do this, enable the NAT-traversal feature, which will attempt to automatically configure the router to allow access to the product. This is enabled from **Setup > System Options > Network > TCP/IP Advanced**.

For more information, see *NAT traversal (port mapping) for IPv4*, on page 47. See also AXIS Internet Dynamic DNS Service at www.axiscam.net

For Technical notes on this and other topics, visit the Axis Support web at www.axis.com/techsup

Set the Root Password

To access the Axis product, you must set the password for the default administrator user **root**. This is done in the **Configure Root Password** dialog, which appears when the product is accessed for the first time.

To prevent network eavesdropping, the root password can be set via an encrypted HTTPS connection, which requires an HTTPS certificate. HTTPS (Hypertext Transfer Protocol over SSL) is a protocol used to encrypt traffic between web browsers and servers. The HTTPS certificate ensures encrypted exchange of information. See *HTTPS*, on page 42.

The default administrator user name **root** is permanent and cannot be deleted. If the password for root is lost, the product must be reset to the factory default settings. See *Reset to Factory Default Settings*, on page 53.

To set the password via a standard HTTP connection, enter it directly in the dialog.

To set the password via an encrypted HTTPS connection, follow these steps:

1. Click **Use HTTPS**.

A temporary certificate (valid for one year) is created, enabling encryption of all traffic to and from the product, and the password can now be set securely.

2. Enter a password and then re-enter it to confirm the spelling.
3. Click **OK**. The password has now been configured.

The Live View Page

The controls and layout of the Live View page may have been customized to meet specific installation requirements and user preferences. Consequently, some of the examples and functions featured here may differ from those displayed in your own Live View page. The following provides an overview of each available control.

Controls on the Live View Page



Click **View size** to scale the image down to 800 pixels wide or to full scale. Only available in MJPEG.



Select a stream profile for the Live View page from the **Stream Profile** drop-down list. For information about how to configure stream profiles, see *page 18*.



Click **Pulse** to activate the product's output port for a defined period of time. For information about how to enable and configure output buttons, see *page 25*.

AXIS P5414–E PTZ Dome Network Camera

Accessing the Product



Click the **Active/Inactive** buttons to manually activate and inactive the product's output port. For information about how to enable and configure output buttons, see *page 25*.



The **Manual Trigger** button is used to trigger an action rule from the Live View page. For information about how to configure and enable the button, see *Manual Trigger, on page 10*.



Click **Snapshot** to save a snapshot of the video image. Right-click the video image to save it in JPEG format on your computer. This button is primarily intended for use when the AXIS Media Control viewer toolbar is not available. Enable this button from **Live View Config > Action Buttons**.

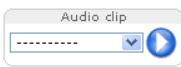

The **Audio clip** drop-down list allows you to play an audio clip from the Live View page. Select the audio clip and click the **Play** button.

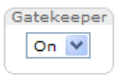

Enable or disable the **Gatekeeper** by selecting **On** or **Off** from the drop-down list. Read more about the Gatekeeper on *page 28*.

Manual Trigger

The **Manual Trigger** is used to trigger an action rule from the Live View page. The manual trigger can for example be used to validate actions during product installation and configuration.

To configure the manual trigger:

1. Go to **Setup > Events**.
2. Click **Add** to add a new action rule.
3. From the **Trigger** drop-down list, select **Input Signal**.
4. From the second drop-down list, select **Manual Trigger**.
5. Select the desired action and configure the other settings as required.

For more information about action rules, see *Events, on page 35*.

To show the manual trigger buttons in the Live View page:

1. Go to **Setup > Live View Layout**.
2. Under **Action Buttons**, select **Show manual trigger button**.

AXIS Media Control viewer toolbar

The AXIS Media Control viewer toolbar is available in Internet Explorer only. See *AXIS Media Control (AMC), on page 13* for more information. The toolbar displays the following buttons:



The **Play** button connects to the Axis product and starts playing a media stream.





The **Stop** button stops the media stream.



The **Snapshot** button takes a snapshot of the video image. The location where the image is saved can be specified in the AMC Control Panel.



AXIS P5414–E PTZ Dome Network Camera

Accessing the Product

-  Click the **View Full Screen** button and the video image will fill the entire screen. Press ESC (Escape) on the computer keyboard to cancel full screen view.
-  The **Record** button is used to record the current video stream. The location where the recording is saved can be specified in the AMC Control Panel. Enable this button from **Live View Config > Viewer Settings**.

AMC Audio Controls

AMC audio buttons control the speakers and microphone connected to the client computer. The buttons are only visible when audio is enabled.

-  **Speaker button** – Click to turn the speakers on or off.
-  **Microphone button** – Click to mute or unmute the microphone. In *Simplex - speaker only mode*, the **Microphone** and **Talk** buttons must both be active to send audio to the Axis product. Click either button to stop audio transmission.



Use the slider to control the volume of the speakers and the microphone.



Half-duplex mode

The **Talk/Listen** button is used to switch between sending and receiving audio. The button can be configured from the Audio tab in the AMC Control panel:

- **Push-To-Talk mode:** Click and hold the button to talk/send. Release the button to listen.
- **Toggle mode:** Click once to switch between talking and listening.

Simplex - speaker only mode



To send audio, the **Talk** and **Microphone** buttons must both be active. Click either button to stop audio transmission.

PTZ Controls

The Live View page also displays Pan/Tilt/Zoom (PTZ) controls. The administrator can enable/disable controls for specified users under **System Options > Security > Users**.

With the **PTZ Control Queue** enabled the time each user is in control of the PTZ settings is limited. Click the buttons to request or release control of the PTZ controls. The PTZ Control Queue is set up under **PTZ > Control Queue**.

Select **Focus window** to define an area of the camera's image that focus should be applied on. If the focus window is set from the Live View page, any change in the camera position will return the autofocus to the entire window. To set a permanent focus window, see *Preset Positions, on page 27*

-  Click the **Emulate joystick mode** button and click in the image to move the camera view in the direction of the mouse pointer.
-  Click the **Center mode** button and click in the image to center the camera view on that position. The center mode button could also be used to zoom in on a specific area. Click in the image and drag to draw a rectangle surrounding the area to be magnified. To zoom out, rotate the mouse wheel.

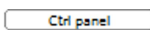

Click the **Ctrl panel** button to open the PTZ control panel which provides additional PTZ controls. User-defined buttons can also appear in the Control panel. See *Controls, on page 29*.

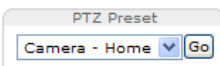

Select a PTZ preset position to steer the camera view to the saved position. See *Preset Positions, on page 27*.

AXIS P5414-E PTZ Dome Network Camera

Accessing the Product

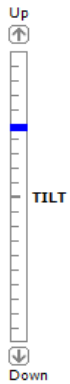

Pan and Tilt bars – Use the arrows to pan and tilt the camera view, or click on a position on the bar to steer the camera view to that position.

Zoom bar – Use the arrows to zoom in and out, or click on a position on the bar to zoom to that position.

Focus bar – Use the arrows to focus the camera, or click on a position on the bar to set the focus position. Using the focus bar will disable the product's autofocus. To re-enable, use the PTZ control panel which is opened by clicking the Ctrl panel button (see above).

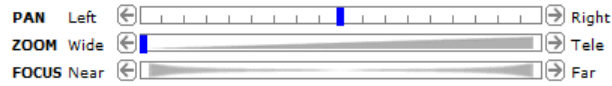

The PTZ controls can be disabled under **PTZ > Advanced > Controls**, see *Controls*, on page 29.

AXIS P5414–E PTZ Dome Network Camera

Media Streams

Media Streams

The Axis product provides several audio and video stream formats. Your requirements and the properties of your network will determine the type you use.

The Live View page in the product provides access to H.264 and Motion JPEG video streams, audio streams and to the list of available stream profiles. Other applications and clients can access video and audio streams directly, without going via the Live View page.

How to Stream H.264

The video compression standard H.264 makes good use of bandwidth, and can provide high quality video streams at less than 1 Mbit/s.

Deciding which combination of protocols and methods to use depends on your viewing requirements, and on the properties of your network. The available options in AXIS Media Control are:

Unicast RTP	This unicast method (RTP over UDP) is used for live unicast video, especially when it is important to always have an up-to-date video stream, even if some images are dropped.	Unicasting is used for video-on-demand transmission so that there is no video traffic on the network until a client connects and requests the stream. Note that there are a maximum of 20 simultaneous unicast connections.
RTP over RTSP	This unicast method (RTP tunneled over RTSP) is useful as it is relatively simple to configure firewalls to allow RTSP traffic.	
RTP over RTSP over HTTP	This unicast method can be used to traverse firewalls. Firewalls are commonly configured to allow the HTTP protocol, thus allowing RTP to be tunneled.	
Multicast RTP	This method (RTP over UDP) should be used for live multicast video. The video stream is always up-to-date, even if some images are dropped. Multicasting provides the most efficient usage of bandwidth when there are large numbers of clients viewing simultaneously. A multicast cannot however, pass a network router unless the router is configured to allow this. It is not possible to multicast over the Internet, for example. Note also that all multicast viewers count as one unicast viewer in the maximum total of 20 simultaneous connections.	

AXIS Media Control negotiates with the Axis product to determine the transport protocol to use. The order of priority, listed in the AMC Control Panel, can be changed and the options disabled, to suit specific requirements.

Note

H.264 is licensed technology. The Axis product includes one H.264 viewing client license. Installing additional unlicensed copies of the client is prohibited. To purchase additional licenses, contact your Axis reseller.

MJPEG

This format uses standard JPEG still images for the video stream. These images are then displayed and updated at a rate sufficient to create a stream that shows constantly updated motion.

The Motion JPEG stream uses considerable amounts of bandwidth, but provides excellent image quality and access to every image contained in the stream. The recommended method of accessing Motion JPEG live video from the Axis product is to use the AXIS Media Control in Internet Explorer in Windows.

AXIS Media Control (AMC)

AXIS Media Control (AMC) in Internet Explorer in Windows is the recommended method of accessing live video from the Axis product.

AXIS P5414–E PTZ Dome Network Camera

Media Streams

The AMC Control Panel can be used to configure various video and audio settings. Please see the AXIS Media Control User's Manual for more information.

The AMC Control Panel is automatically installed on first use, after which it can be configured. Open the AMC Control Panel from:

- Windows Control Panel (from the Start menu)
- Alternatively, right-click the video image in Internet Explorer and click **Settings**.

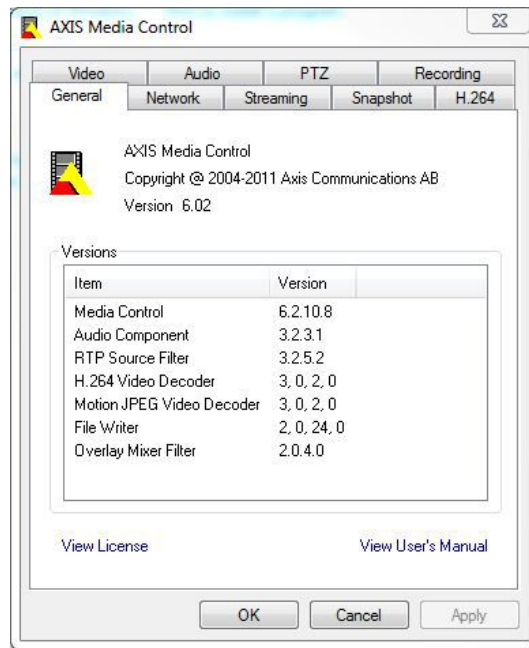

Alternative Methods of Accessing the Video Stream

You can also access video and images from the Axis product in the following ways:

- **Motion JPEG server push** (if supported by the client, Firefox, for example). This option maintains an open HTTP connection to the browser and sends data as and when required, for as long as required.
- **Still JPEG images in a browser**. Enter the path `http://<ip>/axis-cgi/jpg/image.cgi`
- **Windows Media Player**. This requires AXIS Media Control and the H.264 decoder to be installed. The following paths can be used:
 - Unicast via RTP: `axrtpu://<ip>/axis-media/media.amp`
 - Unicast via RTSP: `axrtsp://<ip>/axis-media/media.amp`
 - Unicast via RTSP, tunneled via HTTP: `axrtsphhttp://<ip>/axis-media/media.amp`
 - Multicast: `axrtpm://<ip>/axis-media/media.amp`
- **QuickTime™**. The following paths can be used:
 - `rtsp://<ip>/axis-media/media.amp`
 - `rtsp://<ip>/axis-media/media.3gp`

AXIS P5414–E PTZ Dome Network Camera

Media Streams

Note

- <ip>= IP address
- The Axis product supports QuickTime 6.5.1 and later.
- QuickTime adds latency to the video stream.
- It may be possible to use other players to view the H.264 stream using the paths above, although Axis does not guarantee this.

Accessing Audio Streams

The Live View page provides access to audio through AXIS Media Control; in addition audio can be accessed in the following ways:

- **VAPIX® Application Programming Interface (API)** For more information, visit www.axis.com/developer
- **Windows Media Player** supports simplex audio. The following paths can be used:
 - Unicast via RTP: `axrtpu://<ip>/axis-media/media.amp`
 - Unicast via RTSP: `axrtsp://<ip>/axis-media/media.amp`
 - Unicast via RTSP, tunneled via HTTP: `axrtsphhttp://<ip>/axis-media/media.amp`
 - Multicast: `axrtpm://<ip>/axis-media/media.amp`
- **QuickTime™** supports G.711 and AAC audio encoding. The following paths can be used:
 - `rtsp://<ip>/axis-media/media.amp`
 - `rtsp://<ip>/axis-media/media.3gp`
- The **Java applet** supports simplex audio with G.711 encoding.

AXIS P5414–E PTZ Dome Network Camera

Setting Up the Product

Setting Up the Product

The Axis product can be configured by users with administrator or operator rights. To open the product's Setup pages, click **Setup** in the top right-hand corner of the Live View page.

- **Administrators** have unrestricted access to all settings.
- **Operators** have access to all settings except System Options

See also the online help  .

Basic Setup

Basic Setup provides shortcuts to the settings that should be made before using the Axis product:

1. **Users.** See *page 42*.
2. **TCP/IP.** See *page 45*.
3. **Date & Time.** See *page 44*.
4. **Video Stream.** See *page 17*.
5. **Audio Settings.** See *page 22*.

The Basic Setup menu can be disabled from **System Options > Security > Users**.

AXIS P5414–E PTZ Dome Network Camera

Video and Audio

Video and Audio

The video and audio settings can be used to optimize video and audio quality. You can configure the following:

- Video stream settings. See *page 17*.
- Stream profiles. See *page 18*.
- Camera settings. See *page 18*.
- Overlay image. See *page 20*.
- Privacy mask. See *page 22*.
- Audio settings. See *page 22*.
- Audio clips. See *page 23*.

Video Stream

You can define the following video stream settings from **Video & Audio > Video Stream**:

- Image. See *page 17*.
- H.264. See *page 18*.
- MJPEG. See *page 18*.

The screenshot shows the 'Video Stream Settings' configuration page. On the left is a navigation menu with categories: Basic Setup, Video & Audio (expanded), Live View Config, PTZ, Detectors, Applications, Events, Recordings, Languages, System Options, and About. Under 'Video & Audio', 'Video Stream' is selected. The main content area has tabs for 'Image', 'Audio', 'H.264', and 'MJPEG'. The 'Image' tab is active, showing 'Image Appearance' settings: Resolution (1280x720 (16:9) pixels), Compression (30 [0..100]), and Rotate image (0 degrees). Below is the 'Video Stream' section with 'Maximum frame rate' set to 'Unlimited'. The 'Overlay Settings' section includes checkboxes for 'Include overlay image at the coordinates: X [0] [0..] Y [0] [0..]', 'Include date', and 'Include time'. It also has a text input for 'Include text', a 'Text overlay size' dropdown (small), 'Text color' (white) and 'Text background color' (black) dropdowns, and a 'Place text/date/time at' dropdown (top) of image. At the bottom, there is a 'Preview' section with a video format dropdown (MJPEG) and an 'Open...' button. 'Save' and 'Reset' buttons are at the very bottom.

Image

The default image settings can be configured under **Video & Audio > Video Stream**. Select the Image tab.

The following settings are available:

- **Resolution.** Select the default resolution.
- **Compression.** The compression level affects the image quality, bandwidth and file size of saved images; the lower the compression, the higher the image quality with higher bandwidth requirements and larger file sizes.

AXIS P5414–E PTZ Dome Network Camera

Video and Audio

- **Rotate image.** If required, the image can be rotated.
- **Maximum frame rate.** To avoid bandwidth problems, the frame rate allowed to each viewer can be **Limited** to a fixed amount. Alternatively, the frame rate can be set as **Unlimited**, which means the Axis product always delivers the highest frame rate possible under the current conditions.
- **Overlay settings.** See *Overlay, on page 20*.

Click **Save** to apply the new settings.

H.264

H.264, also known as MPEG-4 Part 10/AVC, is a video compression standard that provides high quality video streams at low bit rates. An H.264 video stream consists of different types of frames such as I-frames and P-frames. An I-frame is a complete image whereas P-frames only contain the differences from previous frames.

The **GOV length** is the number of frames between two consecutive I-frames. Increasing the GOV length may save considerably on bandwidth requirements in some cases, but may also have an adverse affect on image quality.

The Axis product supports two **H.264 profiles**. The Main profile provides higher compression than the Baseline profile with the same video quality, but requires more processing power to decode.

The bit rate can be set as **Variable Bit Rate (VBR)** or **Constant Bit Rate (CBR)**. VBR adjusts the bit rate according to the image complexity, using up more bandwidth for increased activity in the image, and less for lower image activity. CBR allows you to set a fixed **Target bit rate** that consumes a predictable amount of bandwidth. As the bit rate would usually need to increase for increased image activity, but in this case cannot, frame rate and image quality are affected negatively. To partly compensate for this, it is possible to prioritize either frame rate or image quality. Not setting a priority means that frame rate and image quality are equally affected. You must save your settings before they can take effect.

The current bit rate can be set to appear as text overlay. To do this, select the **Include text** check box option under **Overlay Settings** and enter the modifier #b in the field.

MJPEG

Sometimes the image size is large due to low light or complex scenery. Adjusting the maximum frame size helps to control the bandwidth and storage used by the Motion JPEG video stream in these situations. Setting the frame size to the **Default** setting provides consistently good image quality at the expense of increased bandwidth and storage usage in low light. Limiting the frame size optimizes bandwidth and storage usage, but may give poor image quality. To prevent increased bandwidth and storage usage, the maximum frame size should be set to an optimal value.

Stream Profiles

A stream profile is a set of predefined stream settings including resolution, compression, frame rate and overlay settings. Stream profiles can be used:

- When setting up recording using action rules. See *Events, on page 35*.
- When setting up continuous recording. See *Continuous Recording, on page 40*.
- In the Live View page – select the stream profile from the **Stream profile** drop-down list.

For quick setup, use one of the predefined stream profiles. Each predefined profile has a descriptive name, indicating its purpose. If required, the predefined stream profiles can be modified and new customized stream profiles can be created.

To create a new profile or modify an existing profile, go to **Setup > Video & Audio > Stream Profiles**.

To select a default stream profile for the Live View page, go to **Setup > Live View Config**.

Camera Settings

The **Video & Audio > Camera Settings** page provides access to advanced image settings for the Axis product.

AXIS P5414–E PTZ Dome Network Camera

Video and Audio

Image Appearance

Increasing the **Color** level increases the color saturation. The value 100 gives maximum color saturation. The value 0 gives a black and white image.

The image **Brightness** can be adjusted in the range 0–100, where a higher value produces a brighter image.

Increasing the **Sharpness** can increase bandwidth usage. A sharper image might increase image noise especially in low light conditions. A lower setting reduces image noise, but the whole image will appear less sharp.

The **Contrast** changes the relative difference between light and dark. It can be adjusted using the sliderbar.

White Balance

White balance is used to make colors in the image appear the same regardless of the color temperature of the light source. The Axis product can be set to automatically identify the light source and compensate for its color. Alternatively, select the type of light source from the drop-down list. For a description of each available setting, see the online help [?](#).

The **white balance window** is enabled for the Automatic and Automatic outdoor options that appear in the **White balance** drop-down list. Select one of the options from the drop-down list to set the white balance window properties. Select **Automatic** to use the default settings for the Automatic and Automatic outdoor options (in the White balance drop-down list). Select **Custom** to manually set a reference window for white balance in the view area.

Wide Dynamic Range

Wide dynamic range (**Dynamic Contrast**) can improve the exposure when there is a considerable contrast between light and dark areas in the image. Enable WDR in intense backlight conditions. Disable WDR in low light conditions for optimal exposure.

Note

This setting is only possible when using automatic exposure control.

Exposure Settings

Configure the exposure settings to suit the image quality requirements in relation to lighting, frame rate and bandwidth considerations.

Exposure value – Click in the bar to fine-tune the exposure.

Enable Backlight compensation – Enable this option if a bright spot of light, for example a light bulb, causes other areas in the image to appear too dark.

Exposure zones – This settings determines which part of the image is used to calculate the exposure. For most situations, the **Auto** setting can be used. For particular requirement, select a predefined area.

Shutter & Gain

The shutter and gain settings affect the amount of motion blur and noise in the image. To adapt to different lighting, available storage space and bandwidth, it is often necessary to prioritize either low motion blur or low noise. The Axis product allows using different prioritization in normal light and in low light.

Shutter speed is related to the amount of time the shutter is opened and is measured in seconds (s). A slow shutter speed allows more light to reach the sensor and can help produce a brighter image in low light situations. On the other hand, a slow shutter speed can cause moving objects to appear blurry.

Set **Shutter** to

- **Auto** to set the shutter speed automatically. If required, use **Max shutter** to limit the shutter speed to prevent the frame rate from being reduced. For example, to get 30 fps, set Max shutter to 1/30.
- **Fixed** to use a fixed shutter speed.

AXIS P5414–E PTZ Dome Network Camera

Video and Audio

Gain, measured in decibel (dB), is the amount of amplification applied to the image. A high gain may provide a better image in low light situations but will increase the amount of image noise.

Set **Gain** to

- **Auto** to set the gain automatically. If required, use **Max gain** to limit the applied gain.
- **Fixed** to use a fixed gain.

When **Shutter** and **Gain** are both set to **Auto**, it is possible to set the **Priority** between low motion blur and low noise manually and to use a different **Priority** in **Normal Light** and in **Low Light**.

Example

Consider an area where people or vehicles move during the day, but where there should be no movements during night. To be able to, for example, recognize faces or license plates, move the normal light priority slider toward low motion blur. At nighttime, motion detection is more important than identification. Motion blur is acceptable and since low light can cause a lot of noise, move the low light priority slider toward low noise.

Example

If storage space or bandwidth is limited, try using a lower gain. This will reduce image noise and produce smaller image files.

Day/Night

The IR cut filter prevents infrared (IR) light from reaching the image sensor. In poor lighting conditions, for example at night, or when using an external IR lamp, set the IR cut filter to **Off**. This increases light sensitivity and allows the product to "see" infrared light. The image is shown in black and white when the IR cut filter is off.

If using automatic **Exposure control**, set the IR cut filter to **Auto** to automatically switch between **On** and **Off** according to the lighting conditions.

Overlay

Overlays are used to provide extra information, for example for forensic video analysis or during product installation and configuration. Overlays are superimposed over the video stream.

An overlay text can display the current date and time, or a text string. When using a text string, modifiers can be used to display information such as the current bit rate or the current frame rate. For information about available modifiers, see *File Naming & Date/Time Formats* in the online help .

It is also possible to display text when an action rule is triggered, see *Using Overlay Text in an Action Rule*.

To enable overlays:

1. Go to **Video & Audio > Video Stream** and select the **Image** tab.
2. To include an overlay image, select **Include overlay image at the coordinates**. The overlay image must first be uploaded to the Axis product, see *Overlay Image*.
3. To include date and time, select **Include date** and **Include time**.
4. To include a text string, select **Include text** and enter the text in the field. Modifiers can be used, see *File Naming & Date/Time Formats* in the online help .
5. Define text overlay characteristics in the relevant fields.
6. Click **Save**.

To modify the date and time format, go to **System Options > Date & Time**. See *Date & Time*, on page 44.

AXIS P5414–E PTZ Dome Network Camera

Video and Audio

Overlay Image

An overlay image is a static image superimposed over the video stream. The image, for example company logo, is used to provide extra information or to mask a part of the image.

Since it is static, the position and size of an overlay image will remain the same regardless of resolution and Pan/Tilt/Zoom movements. To set up a dynamic mask, which will always mask the specified part of monitored area, see *Privacy Mask*.

To use an overlay image, the image must first be uploaded to the Axis product:

1. Go to **Video & Audio > Overlay Image**.
2. Click **Browse** and browse to the file.
3. Click **Upload**.
4. Select the image to use from the **Use overlay image** list.
5. Click **Save**.

To display the overlay image:

1. Go to **Video & Audio > Video Stream** and select the **Image** tab.
2. Under **Overlay Settings**, select **Include overlay image at the coordinates** and enter the X and Y coordinates.
3. Click **Save**.

For information about supported image formats, see the online help [?](#).

Using Overlay Text in an Action Rule

Action rules, see *page 35*, can display an overlay text when the rule is triggered. The text can be used to provide information for forensic video analysis, notify surveillance operators or validate triggers and actions during product installation and configuration.

To display overlay text when an action rule is triggered, the modifier #D should be used as described below. When the rule is triggered, #D will be replaced by the text specified in the action rule.

Start by enabling overlay text in the video stream:

1. Go to **Video & Audio > Video Stream** and select the **Image** tab.
2. Under **Overlay Settings**, select **Include text**.
3. Enter the modifier #D and, optionally, additional text which will be displayed also when the action rule is not active.

Create the action rule:

1. Go to **Events > Action Rules**
2. Click **Add** to create a new rule.
3. Select a **Trigger** and, optionally, a **Schedule** and **Additional conditions**. See the online help for details.
4. From the **Actions** list, select **Overlay Text**
5. Enter the text to display in the **Text** field. This is the text that #D will be replaced by.
6. Specify the **Duration**. The text can be displayed while the rule is active or for a fixed number of seconds.

Example

To display the text "Motion detected" when motion is detected, enter #D in the **Include text** field and enter "Motion detected" in the **Text** field when setting up the action rule.

AXIS P5414–E PTZ Dome Network Camera

Video and Audio

Privacy Mask

A privacy mask is an area of solid color that prohibits users from viewing parts of the monitored area. Privacy masks cannot be bypassed via the VAPIX® Application Programming Interface (API).

The Privacy Mask List, **Video & Audio > Privacy Mask**, shows all the masks that are currently configured in the Axis product and indicates if they are enabled.

Since the Pan/Tilt/Zoom coordinates define its size and position, a privacy mask is dynamic in relation to the monitored area. This means that regardless of the angle and zoom of the lens, the same place or object will be hidden. To define at what magnification the mask should be displayed, zoom to the desired level and click **Set level**.

You can add a new mask, re-size the mask with the mouse, choose a color for the mask, and give the mask a name.

For more information, see the online help .

Important

Adding many privacy masks may affect the product's performance.

Audio Settings

The audio functionality for each video stream is enabled under **Video & Audio > Video Stream > Audio**.

Audio Modes

The Axis product supports the following audio modes:

Full duplex – Simultaneous two-way audio allowing the Axis product to transmit and receive audio at the same time. There is no echo cancellation; if feedback loops appear, try moving the microphone or the speaker.

Half-duplex – Audio can be transmitted to and from the Axis product but only in one direction at a time. To transmit audio using the Live View page, use the **Talk** and **Listen** buttons, see *AMC Audio Controls, on page 11*.

Simplex – speaker only – Audio is transmitted from a client to the Axis product and can be played by a speaker connected to the product. To transmit audio using the Live View page, the **Talk** and **Microphone** buttons must both be active, see *AMC Audio Controls, on page 11*.

Simplex – microphone only – Audio captured by the product microphone is transmitted from the Axis product to one or more clients.

To set the audio mode, go to **Video & Audio > Audio Settings** and select the desired mode from the **Audio mode** drop-down list.

Audio Input

Select **Microphone** to use an external microphone or **Line** to use a Line in device, e.g. an audio mixer for multiple microphones or a microphone with a built-in amplifier, as audio source.

Select the microphone sensitivity level (**High/Low**) depending on the sound level in the monitored area. For example, if the Axis product is installed in a noisy environment, try setting the input sensitivity to **Low**.

The **Microphone power** option provides DC power for an external microphone. Microphone power should only be used with microphones that have no battery. This setting should not be enabled when using a dynamic or battery powered microphone. Microphone power will not harm the microphone; if you are uncertain, try switching it off and on. To use a professional microphone requiring 48 V phantom power, you need an external power supply and a balanced-unbalanced converter (audio transformer) in between.

Use the **Input gain** to control the volume (dB Full Scale) of the audio input. If the sound is too low, choose a higher dB, to amplify the sound. If the sound is too high, choose a lower dB. The **Level** bar gives a visual representation of the audio signal level in dB relative to the full-scale input level.

- Green – the signal is at a good level.

AXIS P5414–E PTZ Dome Network Camera

Video and Audio

- Yellow – the signal is becoming distorted.
- Red – the signal is distorted.

Use the **Encoding** option to select digital audio encoding format.

- **AAC** requires a license for both encoding and decoding. AAC is the least complicated and most widely used codec. If achieving the best possible audio quality is a priority, AAC is the recommended codec to use. An AAC license is included in the Axis product.
- **G711** is an unlicensed standard codec that is useful when integrating audio into a VoIP system
- **G726** is an unlicensed speech codec that is most commonly used within the security industry.

The **Sample rate** defines the number of times per second the sound is sampled. A higher sample rate will provide better audio quality, but also requires a greater bandwidth.

Set the required **Bit rate** depending on the selected encoding. A higher bit rate will give better audio quality. A lower bit rate may have latency or delay, but will require less bandwidth.

For more information about these settings, please see the online help .

Audio Output

Configure the audio output settings under **Video & Audio > Audio Settings**.

Output gain – Control the volume (dB Full Scale) of the line audio output. If the sound is too low, choose a higher dB. If the sound is too high, choose a lower dB.

Audio Clips

An audio clip is a sound file that can be played when events occur or directly from the **Live View** page. The audio clip must first be uploaded to the Axis product or recorded by a microphone connected to the product.

To add, download, modify or remove audio clips, go to **Video & Audio > Audio Clips**. For more information see the online help .

To configure the Axis product to play audio clips when an event occurs, an action rule must be set up. For more information, see *Events*, on page 35.

Note

Audio clips cannot be used if the product's audio functionality is enabled. The audio functionality is enabled on the **Audio** tab under **Video & Audio > Video Stream**.

AXIS P5414–E PTZ Dome Network Camera

Live View Config

Live View Config

You can customize the Live View page and alter it to suit your requirements. It is possible to define the following features of the Live View page.

- Stream Profile. See *page 18*.
- Default Viewer for Browser. See *page 24*.
- Viewer Settings. See *page 25*.
- Action Buttons. These are the buttons described in *Controls on the Live View Page, on page 9*.
- User Defined Links. See *page 25*.
- Output Buttons. See *page 25*.

Live View Layout

Stream Profile
Stream profile: MJPEG
 Show stream profile selection

Default Viewer
Windows Internet Explorer: AMC (ActiveX)
Other Browsers: Server push
Note: QuickTime is only used with H.264. Motion JPEG will be shown with AMC in Windows Internet Explorer and with server push in other browsers.

Viewer Settings
 Show viewer toolbar
 Enable H.264 decoder installation
 Show crosshair in PTZ joystick mode*
 Use PTZ joystick mode as default*
 Enable recording button
*Not applicable to AMC (ActiveX).

Action Buttons
 Show manual trigger button for Video
 Show snapshot button
 Show audio clip section

User Defined Links
 Show custom link 1 Use as: cgi link web link
Name: Custom link 1 URL: http://
 Show custom link 2 Use as: cgi link web link
Name: Custom link 2 URL: http://
 Show custom link 3 Use as: cgi link web link
Name: Custom link 3 URL: http://
 Show custom link 4 Use as: cgi link web link
Name: Custom link 4 URL: http://

Output Buttons
No outputs are specified.

Save Reset

Default Viewer for Browsers

From Live View Config > Default Viewer select the default method for viewing video images in your browser. The product attempts to show the video images in the selected video format and viewer. If this is not possible, the product overrides the settings and selects the best available combination.

AXIS P5414–E PTZ Dome Network Camera

Live View Config

Browser	Viewer	Description
Windows Internet Explorer	AMC	Recommended viewer in Internet Explorer (H.264/Motion JPEG).
	QuickTime	H.264.
	Java applet	A slower imaging alternative to AMC (Motion JPEG). Requires one of the following installed on the client: <ul style="list-style-type: none">• JVM (J2SE) 1.4.2 or higher.• JRE (J2SE) 5.0 or higher.
	Still image	Displays still images only. Click the Refresh button in your browser to view a new image.
Other browsers	Server Push	Recommended viewer for other browsers (Motion JPEG).
	QuickTime	H.264.
	Java applet	A slower imaging alternative to Server Push (Motion JPEG only).
	Still image	Displays still images only. Click the Refresh button in your browser to view a new image.

For more information, please see the online help .

Viewer Settings

To configure options for the viewer, go to **Live View Config > Viewer Settings**.

- Select **Show viewer toolbar** to display the AXIS Media Control (AMC) or the QuickTime viewer toolbar under the video image in your browser.
- **H.264 decoder installation.** The administrator can disable installation of the H.264 decoder included with AXIS Media Control. This is used to prevent installation of unlicensed copies. Further decoder licenses can be purchased from your Axis reseller.
- Select **Show crosshair in PTZ joystick mode** to enable a cross that will indicate the center of the image in PTZ joystick mode.
- Select **Use PTZ joystick mode as default** to enable joystick mode. The mode can be changed temporarily from the PTZ control panel.
- Select **Enable recording button** to enable recording from the Live View page. This button is available when using the AMC viewer. The recordings are saved to the location specified in the AMC Control Panel. See *AXIS Media Control (AMC)*, on page 13.

User Defined Links

To display user-defined links in the Live View page, select the **Show custom link** option, give the link a name and then enter the URL to link to. When defining a web link do not remove the 'http:/' from the URL address. Custom links can be used to run scripts or activate external devices connected to the product, or they can link to a web page. Custom links defined as cgi links will run the script in the background, in a hidden frame. Defining the link as a web link will open the link in a new window.

Output Buttons

External I/O devices connected to the Axis product's output ports can be controlled directly from the Live View page.

To display output buttons in the Live View page:

1. Go to **Setup > Live View Config**.
2. Under **Output Buttons**, select the type of control to use:

AXIS P5414–E PTZ Dome Network Camera

Live View Config

- **Pulse** activates the output for a defined period of time. The pulse time can be set from 1/100 second to 60 seconds.
- **Active/Inactive** displays two buttons, one for each action.

To configure the active and inactive states, go to **System Options > Ports & Devices > I/O Ports** and set the port's **Normal state**.

For more information about I/O ports, see *I/O Ports*, on page 51.

AXIS P5414–E PTZ Dome Network Camera

PTZ (Pan Tilt Zoom)

PTZ (Pan Tilt Zoom)

Preset Positions

A preset position is a predefined view that can be used to quickly steer the camera to a specific location. Preset positions can be accessed in several ways:

- By selecting the preset from the **Preset positions** drop-down list in the Live View Page.
- When setting up action rules. See *page 35*.
- When setting up Guard Tour. See *page 28*.
- When setting up the Gatekeeper. See *page 28*

To add a preset position:

1. Go to **PTZ > Preset Positions**.
2. Use the pan, tilt and zoom controls to steer the camera view to the desired position.
3. Enter a descriptive name in the **Current position** field.
4. If required, select **Use current position as Home**.
5. Click **Add**. The camera's position and focus settings are saved as a preset position.

The **Home** position is readily accessible by clicking the **Home** button on the Live View page and in the Preset Positions setup window.

To set a customized home position, select **Use current position as Home** when adding a preset position. The user-defined home position will have (H) added, for example, Entrance (H). The default Home position, called "Home", will still be available.

The product can be configured to return to the Home position when the PTZ functionality has been inactive for a specified length of time. Enter the length of time in the **Return to home when inactive** field and click **Save**. Set the time to zero to prevent the product from automatically returning to the Home position.

To include the preset position name in the overlay text, go to **Video & Audio**, select **Include overlay text** and enter the modifier #P in the field. For more information about modifiers, see *File Naming & Date/Time Formats* in the online help .

Focus Window

The focus window makes it possible to select an area of the camera's image that focus should be applied on. This can be useful if there is a part of the image where focus is more critical, or if a part of the image should be ignored by the autofocus.

If the focus window is set from the Live View page, any change in the camera position will return the autofocus to the entire window.

If the focus window is set from the Preset Positions page, it will be included in the settings for that preset. The focus window can be redefined for the preset, but it cannot be deleted unless the preset is deleted.

AXIS P5414–E PTZ Dome Network Camera

PTZ (Pan Tilt Zoom)

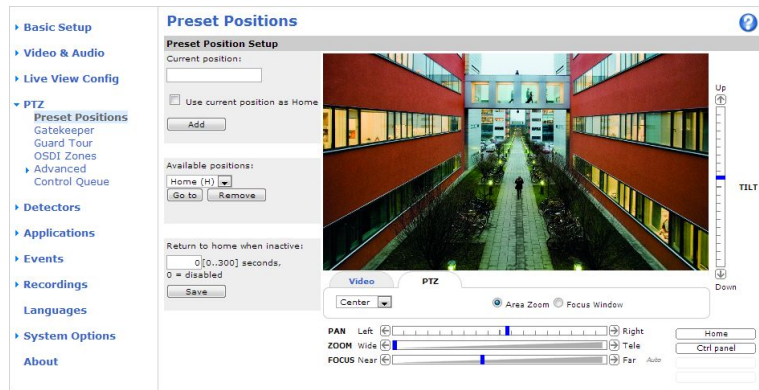

Gatekeeper

The Advanced Gatekeeper monitors an area such as an entrance gate. When motion is detected in the monitored area, the Gatekeeper will steer the camera to a selected preset position. Using a zoomed-in preset position can make it possible to, for example, read a license plate or identify a person. When motion is no longer detected, the camera returns to its Home position after a defined time.

To enable the Gatekeeper, go to **PTZ > Gatekeeper** and follow the online instructions.

It is also possible to, for example, record video or save images (take a snapshot) while the Gatekeeper is active. Go to **Events** and set up an action rule with **PTZ Preset Reached** as trigger.

Guard Tour

A guard tour displays the video stream from different preset positions, one-by-one, in a predetermined order or at random and for configurable time periods. The enabled guard tour will keep running after the user has logged off or closed the browser.

To add a guard tour:

1. Go to **PTZ > Guard Tour** and click **Add**.
2. Enter a descriptive name.
3. Specify the pause length between runs.
4. Select an available preset position and click **Apply**.
5. Specify the **Move Speed**.
6. Specify the **View Time** in seconds or minutes.
7. Specify the **View Order** or select the **Random view order** option.
8. Click **Save**.

To modify or remove guard tours, go to **PTZ > Guard Tour**, select the guard tour in the **Guard Tour List** and click **Modify/Remove**.

For more information see the online help .

OSDI Zones

On-Screen Direction Indicator (OSDI) zones can be included in the overlay text (see *Overlay, on page 20*) to aid the user to navigate the Axis product. Each OSDI zone is set up with coordinates and a descriptive name.

OSDI zones are set up under **PTZ > OSDI Zones**. The Axis product uses the coordinates of the center of the view to set the lower left and upper right zone areas. First navigate to where you would like the lowermost left point of the OSDI zone to be located.

AXIS P5414–E PTZ Dome Network Camera

PTZ (Pan Tilt Zoom)

Click **Get** to set the coordinates. Proceed to where the upper right point of zone should be located and click **Get**. Give the zone a descriptive name and click **OK**.

To include the name of the OSDI zone in the overlay text, go to **Video & Audio < Video Stream < Overlay Settings**. Check the **Include text** box and enter the modifier #L in the field. For more information about modifiers, see *File Naming & Date/Time Formats* in the online help .

Advanced

Limits

Define the pan, tilt, zoom and focus limits for the Axis product. Movements to the left and right, up and down, can be restricted to narrow the area under surveillance.

Configure the near focus limit to avoid focusing on objects too close to the camera lens.

Move speed sets the speed of the camera's pan and tilt movements. The default setting is maximum speed.

When using a joystick (or emulating one with the mouse) the **Enable proportional speed** setting can be used to reduce the maximum pan/tilt movement speed, i.e. the speed the camera view moves at when the joystick is pushed all the way out in any direction. This is useful then the view is zoomed in on an object.

See the online help  for more information.

Controls

Panel Shortcut Command Buttons can be configured to provide direct access to commands issued via the VAPIX® Application Programming Interface. The buttons will be displayed in the PTZ control panel, which is available in the Live View page through the **Ctrl panel** button, see *page 11*.

Deselect the options under **Enable/Disable controls** to disable the pan, tilt, zoom and focus controls.

Note

Disabling PTZ controls will not affect preset positions. For example, if the tilt control is disabled, the product can still move to preset positions that require a tilt movement.

Control Queue

The administrator can set up a queue for PTZ controllers from **PTZ > Control Queue**. Once set up, the **PTZ Control Queue** buttons appear in the Live View page offering one viewer exclusive control for a limited period of time. Other users will be placed in queue.

A user who belongs to a group (see *Users, on page 42*) with a higher PTZ priority can go before other users in the queue and take control of the product. The order of priority is as follows:

1. **Administrator** – An administrator takes over PTZ control regardless of who is first in queue. The administrator will be removed from the queue 60 seconds after the last PTZ control command.
2. **Event** – The Axis product can be configured to go to a preset position when triggered by an alarm (see *Events, on page 35*). The event will immediately be placed first in the queue except when an administrator is in control.
3. **Operator** – Same as administrator but with lower priority
4. **Guard Tour** – A guard tour (see *page 28*) has PTZ control for an indefinite period of time. It may be overridden by an operator, event or administrator. The guard tour will resume when higher priority groups leave the queue.
5. **Viewer** – Multiple viewers must wait for their turn. The viewer has 60 seconds PTZ control before control is passed on to the next viewer in queue.

AXIS P5414–E PTZ Dome Network Camera

PTZ (Pan Tilt Zoom)

Note

- The administrator can enable and disable PTZ controls for selected users.
- To identify different users in the viewer group, cookies must be enabled on the client.

AXIS P5414–E PTZ Dome Network Camera

Detectors

Detectors

Motion Detection

Motion detection is used to generate an alarm whenever movement starts or stops in the camera view.

Motion detection is configured by defining up to 10 Include and Exclude windows:

- **Include windows** – define areas where motion should be detected
- **Exclude windows** – define areas within an Include window that should be ignored (areas outside Include windows are automatically ignored).

For instructions, see *Set Up Motion Detection Windows, on page 31*.

To control the number of motion detection alarms, the parameters **Object Size**, **History** and **Sensitivity** can be adjusted. See *Motion Detection Parameters, on page 32*.

Once motion detection windows are configured, the Axis product can be configured to perform actions when motion is detected. Possible actions include uploading images and start recording. For more information, see *Setting Up an Action Rule, on page 36*.

Note

- Using the motion detection feature may decrease the product's overall performance.
- The position of the Motion Detection Window is relative to the orientation of the Camera. Changing the orientation of the camera will also change the position of the Motion Detection Window.



Set Up Motion Detection Windows

To set up a motion detection Include Window, follow these instructions:

1. Go to **Detectors > Motion Detection**.
2. Select the **Configure Included Windows** option and click **New**. Select the new window in the list of windows and enter a descriptive name.
3. Adjust the size (drag the bottom right-hand corner) and the position (click on the text at the top and drag to the desired position) of the window.
4. Adjust the **Object Size**, **History** and **Sensitivity** profile sliders (see *Motion Detection Parameters* for details). Any detected motion within an active window is indicated by red peaks in the **Activity** window.
5. Click **Save**.

To exclude parts of the include window, select the **Configure Excluded Windows** and position the exclude window within the include window.

To delete an include or exclude window, select the window in the list of windows and click **Del**.

AXIS P5414–E PTZ Dome Network Camera

Detectors

Motion Detection Parameters

The parameters controlling motion detection are described in the table below:

Parameter	Object Size	History	Sensitivity
Description	Object size relative to window size.	Object memory length.	Difference in luminance between background and object.
High level (100%)	Only very large objects trigger motion detection.	An object that appears in the window triggers motion detection for a long time before it is considered as non-moving.	Ordinary colored objects on ordinary backgrounds trigger motion detection.
Medium level (50%)			A large difference in luminance is required to trigger motion detection.
Low level (0%)	Even very small objects trigger motion detection.	An object that appears in the window triggers motion detection only for a very short time before it is considered as non-moving.	Only very bright objects on a dark background trigger motion detection.
Recommended values	5–15%	60–90%	75–95%
Default values	15%	90%	90%

Note

- To trigger on small objects or movements, use several small motion detection windows rather than one large window and select a low object size.
- To avoid triggering on small objects, select a high object size.
- While monitoring an area where moving objects are not expected, select a high history level. This will cause motion detection to trigger as long as the object is present in the window.
- To only detect flashing light, select a low sensitivity. In other cases high sensitivity is recommended.

Audio Detection

The Axis product can be configured to generate an alarm when audio rises above or falls below the threshold value. The threshold value can be set in the range 0–100 where 0 is the most sensitive and 100 the least sensitive.

1. Go to **Detectors > Audio Detection**.
2. Set the audio alarm level and click **Save**.
3. Go to **Events > Action Rules** and set up an action rule, see *Setting Up an Action Rule, on page 36*.

Detected audio is indicated by colored peaks in the **Activity** indicator. An event is triggered when detected audio rises above or falls below the threshold value, which is represented by the bar.

AXIS P5414–E PTZ Dome Network Camera

Applications

Applications

Third party applications can be uploaded to and installed on the Axis product. Applications add functionality to the product, for example video analytics and intelligent video capabilities such as recognition, tracking, detection and counting. For information about available applications, downloads, trials and licenses, go to www.axis.com/applications

Note

- It is recommended to run one application at a time.
- Avoid running applications when the built-in motion detection is active.

Application Licenses

Some applications need a license to run. Licenses can be installed in two ways:

- Automatic installation – requires access to the Internet
- Manual installation – obtain the license key from the application vendor and upload the key to the Axis product

To request a license, the Axis product serial number (S/N) is required. The serial number can be found on the product label and under **System Options > Support > System Overview**.

Install Application

To install and start an application:

1. Go to **Setup > Applications**.
2. Under **Upload Application**, click **Browse**. Locate the application file and click **Upload Package**.
3. Install the license (if applicable). For instructions, see the documentation provided by the application vendor.
4. Start the application. Go to page **Applications**, select the application in the list of installed applications and click **Start**.
5. Configure the application. For instructions, see the documentation provided by the application vendor.

Note

- Applications can be uploaded by product administrators.
- Applications and licenses can be installed on multiple products at the same time using AXIS Camera Management, version 3.10 and later.

To generate a log file for the application, go to **Applications**. Select the application and click **Log**.

Application Considerations

If an application is upgraded, application settings, including the license, will be removed. The license must be reinstalled and the application reconfigured.

If the Axis product's firmware is upgraded, installed applications and their settings will remain unchanged, although this is not guaranteed by Axis Communications AB. Note that the application must be supported by the new firmware. For information about firmware upgrades, see *Upgrading the Firmware*.

If the Axis product is restarted, running applications will restart automatically.

If the Axis product is restored, installed applications remain unchanged but must be restarted. To start the application, go to **Setup > Applications**. Select the application in the list of installed applications and click **Start**. For information about restoring the Axis product, see *Maintenance*.

AXIS P5414–E PTZ Dome Network Camera

Applications

If the Axis product is reset to factory default, installed applications and their settings are removed. For information about factory default, see *Reset to Factory Default Settings*.

AXIS P5414–E PTZ Dome Network Camera

Events

Events

The Axis product can be configured to perform actions when different events occur, for example, start a recording when motion is detected. The set of conditions that defines how and when the action is triggered is called an **Action Rule**.

Available Action Rule triggers and conditions include:

- **Applications** – use installed applications to trigger the rule, see *Applications, on page 33*.
- **Detectors**
 - **Audio Detection** – trigger the rule when audio is detected, see *Audio Detection, on page 32*.
 - **Day/Night Mode** – trigger the rule when the product switches between day mode (IR cut filter on) and night mode (IR cut filter off). This can for example be used to control an external infrared (IR) light connected to an output port.
 - **Live Stream Accessed** – trigger the rule when any stream is accessed and during edge storage playback. This can for example be used to send notifications.
 - **Motion Detection** – trigger the rule when motion is detected, see *Motion Detection, on page 31*.
- **Hardware**
 - **Network** – trigger the rule if network connection is lost or restored. This can for example be used to start recording to the SD card.
 - **Temperature** – trigger the rule if the temperature falls outside or inside the operating range of the product. This can for example be used to send maintenance notifications.
- **Input Signal**
 - **Digital Input Port** – trigger the rule when an I/O port receives a signal from a connected device, see *I/O Ports, on page 51*.
 - **Manual Trigger** – trigger the rule using the **Manual Trigger** button in the Live View page, see *Controls on the Live View Page, on page 9*. This can for example be used to validate actions during product installation and configuration.
 - **Virtual Inputs** – can be used by a VMS (Video Management System) to trigger actions. Virtual inputs can, for example, be connected to buttons in the VMS user interface.
- **PTZ**
 - **Error** – trigger the rule if the PTZ functionality is not working correctly. This can for example be used to send maintenance notifications.
 - **Moving** – trigger the rule when the camera view moves due to a PTZ operation. This can for example be used as an additional condition to prevent an action rule triggered by motion detection to record video while the camera view moves due to a PTZ operation.
 - **Preset Reached** – trigger the rule when the camera stops at a preset position. This can be for example be used with the Send Images action to upload images from the preset position.
 - **Ready** – trigger the rule when the PTZ functionality is ready to be used. This can for example be used to steer the camera to a specific preset position when the product is started.
- **Storage**
 - **Disruption** – trigger the rule if storage problems are detected, for example if the storage device is unavailable, removed, full, locked or if other read or write problems occur. This can for example be used to send maintenance notifications.

AXIS P5414–E PTZ Dome Network Camera

Events

- **Recording** – triggers the rule when the Axis product records to the storage device. The recording status trigger can be used to notify the operator, for example by flashing LED lights, if the product has started or stopped to record to the storage device. Note that, this trigger can be used only for edge storage recording status.
- **System**
 - **System Ready** – trigger the rule when the product has been started and all services are running. This can for example be used to send a notification when the product restarts.
- **Time**
 - **Recurrence** – trigger the rule periodically, see *Recurrences, on page 38*. This can for example be used to upload an image every 5 minutes.
 - **Use Schedule** – trigger the rule according to the selected schedule, see *Schedules, on page 38*.

Available actions include:

- **Day/Night Vision Mode** – set day mode (IR cut filter on) or night mode (IR cut filter off).
- **Output Port** – activate an I/O port to control an external device.
- **Overlay Text** – display an overlay text, see *Using Overlay Text in an Action Rule, on page 21*.
- **Play Audio Clip** – see *Audio Clips, on page 23*.
- **PTZ Control**
 - **Preset Position** – go to a preset position.
 - **Guard Tour** – start a guard tour, see *Guard Tour, on page 28*.
- **Record Video** – record video to a selected storage.
- **Send Images** – send images to a recipient.
- **Send Notifications** – send a notification message to a recipient.
- **Send Video Clip** – send a video clip to a recipient.

Setting Up an Action Rule

An action rule defines the conditions that must be met for the product to perform an action, for example record video or send an email notification. If multiple conditions are defined, all of them must be met to trigger the action.

The following example describes how to set up an action rule to record video to a network share if there is movement in the camera's field of view.

Set up motion detection and add a network share:

1. Go to **Detectors > Motion Detection** and configure a motion detection window, see *page 31*
2. Go to **System Options > Storage** and set up the network share, see *page 50*.

Set up the action rule:

1. Go to **Events > Action Rules** and click **Add**.
2. Select **Enable rule** and enter a descriptive name for the rule.
3. Select **Detectors** from the **Trigger** drop-down list.
4. Select **Motion Detection** from the drop-down list. Select the motion detection window to use.
5. Optionally, select a **Schedule** and **Additional conditions**, see below.

AXIS P5414–E PTZ Dome Network Camera

Events

6. Under **Actions**, select **Record Video** from the **Type** drop-down list.
7. Select a **Stream profile** and configure the **Duration** settings as described below.
8. Select **Network Share** from the **Storage** drop-down list.

To add additional criteria, select the **Additional conditions** option and add additional triggers. To prevent an action from being triggered repeatedly, a **Wait at least** time can be set. Enter the time in hours, minutes and seconds, during which the trigger should be ignored before the action rule can be activated again.

The recording **Duration** of some actions can be set to include time immediately before and after the event. Select **Pre-trigger time** and/or **Post-trigger time** and enter the number of seconds. When **While the rule is active** is enabled and the action is triggered again during the post-trigger time, the recording time will be extended with another post-trigger time period.

For more information, see the online help .

Fallback Action

A fallback action is started if the primary action cannot be started, for example if connection to a recipient cannot be established.

Fallback actions are typically used to send email notifications on failed actions or to upload images to a secondary recipient.

Recipients

Recipients receive media files and notification messages. The following recipients are available:

Recipient	Use with action
Email ¹	Send Images Send Notification Send Video Clip
FTP	Send Images Send Video Clip
HTTP	Send Images Send Notification Send Video Clip
HTTPS	Send Images Send Notification Send Video Clip
Network Share ²	Send Images Send Video Clip
TCP	Send Notification

1. Some email providers have security filters that prevent users from receiving or viewing large amount of attachments, from receiving scheduled emails and similar. Check the email provider's security policy to avoid delivery problems and locked email accounts.
2. A network share can also be used as a storage device for recorded video. Go **System Options > Storage** to configure a network share before setting up a continuous recording or an action rule to record video. See *Storage, on page 50* for more information about storage devices.

To add a recipient:

1. Go to **Events > Recipients** and click **Add**.

AXIS P5414–E PTZ Dome Network Camera

Events

2. Enter a descriptive name.
3. Select a recipient **Type**.
4. Enter the information needed for the recipient type.
5. Click **Test** to test the connection to the recipient.
6. Click **OK**.

Setting Up an Email Recipient

Email recipients can be configured by selecting one of the listed email providers, or by specifying the SMTP server, port and authentication used by, for example, a corporate email server.

Note

Some email providers have security filters that prevent users from receiving or viewing large amount of attachments, from receiving scheduled emails and similar. Check the email provider's security policy to avoid delivery problems and locked email accounts.

To set up an email recipient using one of the listed providers:

1. Go to **Events > Recipients** and click **Add**.
2. Enter a **Name** and select **Email** from the **Type** list.
3. Enter the email addresses to send emails to in the **To** field. Use commas to separate multiple addresses.
4. Select the email provider from the **Provider** list.
5. Enter the user ID and password for the email account.
6. Click **Test** to send a test email.

To set up an email recipient using for example a corporate email server, follow the instructions above but select **User defined as Provider**. Enter the email address to appear as sender in the **From** field. Select **Advanced settings** and specify the SMTP server address, port and authentication method. Optionally, select **Use encryption** to send emails over an encrypted connection. The server certificate can be validated using the certificates available in the Axis product. For information on how to upload certificates, see *Certificates, on page 43*.

Schedules

Schedules can be used as action rule triggers or as additional conditions, for example to record video if motion is detected outside office hours. Use one of the predefined schedules or create a new schedule as described below.

To create a new schedule:

1. Go to **Events > Schedules** and click **Add**.
2. Enter a descriptive name and the information needed for a daily, weekly, monthly or yearly schedule.
3. Click **OK**.

To use the schedule in an Action Rule, select the schedule from the **Schedule** drop-down list in the Action Rule Setup page.

Recurrences

Recurrences are used to trigger Action Rules repeatedly, for example every 5 minutes or every hour.

To set up a recurrence:

AXIS P5414–E PTZ Dome Network Camera

Events

1. Go to **Events > Recurrences** and click **Add**.
2. Enter a descriptive name and recurrence pattern.
3. Click **OK**.

To use the recurrence in an Action Rule, first select **Time** from the **Trigger** drop-down list in the Action Rule Setup page and then select the recurrence from the second drop-down list.

To modify or remove recurrences, select the recurrence in the **Recurrences List** and click **Modify** or **Remove**.

AXIS P5414–E PTZ Dome Network Camera

Recordings

Recordings

The Axis product can be configured to record video continuously or according to an action rule:

- To start a continuous recording, see *page 40*.
- To set up action rules, see *page 36*.
- To access recordings, see *Recording List, on page 40*.
- To configure camera controlled storage, see *Storage, on page 50*.

Recording List

Recorded videos are listed on the **Recordings > List** page. The list shows each recording's start date and time, duration and the event that triggered the recording.

To play or download a recording, follow these steps:

1. Go to **Recordings > List**.
2. Use the filter to narrow the list of recordings. Enter the desired filter criteria and click **Filter**. Some filters may take a long time to complete.
3. Select the recording.
4. Click **Play** to play the recording, or click **Download** to download the recording.

Multiple recordings can be downloaded at the same time. Select the recordings and click **Download**. The downloaded file is a zip file containing a minimum of three files, of which the Matroska (mkv) files are the actual recordings. The recordings are time-stamped with the date and time they were downloaded (that is, not the date the recordings were made).

Note

To play recordings in Windows Media Player, AXIS Matroska File Splitter must be installed. AXIS Matroska File Splitter can be downloaded from www.axis.com/techsup/software

For detailed recording and video information, select a recording and click **Properties**.

To remove a recording, select the recording and click **Remove**.

Continuous Recording

The Axis product can be configured to continuously save video to a storage device. See *Storage, on page 50* for more information about storage devices. To prevent the disk from becoming full, it is recommended to configure the disk to automatically remove old recordings. If a new stream profile is selected while a recording is ongoing, the recording will be stopped and saved in the recording list and a new recording with the new stream profile will start. All previous continuous recordings will remain in the recording list until they are removed manually or through automatic removal of old recordings.

To start a continuous recording, follow these steps:

1. Go to **Recordings > Continuous**.
2. Select **Enabled**.
3. Select type of storage device from the **Disk** list.
4. Select a **Stream profile** to use for continuous recordings.
5. Click **Save** to save and start the recording.

AXIS P5414–E PTZ Dome Network Camera

Languages

Languages

Multiple languages can be installed in the Axis product. All web pages including the online help will be displayed in the selected language. To switch languages, go to **Setup > Languages** and first upload the new language file. Browse and locate the file and click the **Upload Language** button. Select the new language from the list and click **Save**.

Note

- Resetting the product to factory default settings will erase any uploaded language file and reset the product language to English.
- Clicking the **Restore** button on the Maintenance page will not affect the language.
- A firmware upgrade will not affect the language used. However if you have uploaded a new language to the product and later upgrade the firmware, it may happen that the translation no longer matches the product's web pages. In this case, upload an updated language file.
- A language already installed in the product will be replaced when a current or a later version of the language file is uploaded.

AXIS P5414–E PTZ Dome Network Camera

System Options

System Options

Security

Users

User access control is enabled by default and can be configured under **System Options > Security > Users**. An administrator can set up other users by giving them user names and passwords. It is also possible to allow anonymous viewer login, which means that anybody may access the Live View page.

The user list displays authorized users and user groups (access levels):

Viewer – Access to the Live View page

Operator – Access to the Live View page and to all settings except System Options

Administrator – Unrestricted access to all settings; can add, modify and remove other users.

Under **HTTP/RTSP Password Settings**, select the type of password to allow. You may need to allow unencrypted passwords if there are viewing clients that do not support encryption, or if you upgraded the firmware and existing clients support encryption but need to log in again and be configured to use this functionality.

Under **User Settings**, select the **Enable anonymous viewer login** option to allow anonymous users access to the Live View page.

Select the **Enable anonymous PTZ control login** to allow anonymous users access to the PTZ controls.

Deselect the **Enable Basic Setup** option to hide the Basic Setup menu. Basic Setup provides quick access to settings that should be made before using the Axis product.

ONVIF

ONVIF (Open Network Video Interface Forum) is a global interface standard that makes it easier for end users, integrators, consultants, and manufacturers to take advantage of the possibilities offered by network video technology. ONVIF enables interoperability between different vendor products, increased flexibility, reduced cost and future-proof systems.

By creating a user you automatically enable ONVIF communication. Use the user name and password with all ONVIF communication with the product. For more information see www.onvif.org

IP Address Filter

IP address filtering is enabled on the **System Options > Security > IP Address Filter** page. Once enabled, the listed IP address are allowed or denied access to the Axis product. Select **Allow** or **Deny** from the list and click **Apply** to enable IP address filtering.

The administrator can add up to 256 IP address entries to the list (a single entry can contain multiple IP addresses).

HTTPS

HTTPS (HyperText Transfer Protocol over Secure Socket Layer, or HTTP over SSL) is a web protocol providing encrypted browsing. HTTPS can also be used by users and clients to verify that the correct device is being accessed. The security level provided by HTTPS is considered adequate for most commercial exchanges.

The Axis product can be configured to require HTTPS when users from different user groups (administrator, operator, viewer) connect.

To use HTTPS, an HTTPS certificate must first be installed. Go to **System Options > Security > Certificates** to install and manage certificates. See *Certificates, on page 43*.

To enable HTTPS on the Axis product:

1. Go to **System Options > Security > HTTPS**

AXIS P5414–E PTZ Dome Network Camera

System Options

2. Select an HTTPS certificate from the list of installed certificates.
3. Optionally, click **Ciphers** and select the encryption algorithms to use for SSL.
4. Set the **HTTPS Connection Policy** for the different user groups.
5. Click **Save** to enable the settings.

To access the Axis product via the desired protocol, enter `https://` or `http://` in the address field in a browser.

The HTTPS port can be changed on the **System Options > Network > TCP/IP > Advanced** page.

IEEE 802.1X

IEEE 802.1X is a standard for port-based Network Admission Control providing secure authentication of wired and wireless network devices. IEEE 802.1X is based on EAP (Extensible Authentication Protocol).

To access a network protected by IEEE 802.1X, devices must be authenticated. The authentication is performed by an authentication server, typically a **RADIUS server**, examples of which are FreeRADIUS and Microsoft Internet Authentication Service.

In Axis implementation, the Axis product and the authentication server identify themselves with digital certificates using EAP-TLS (Extensible Authentication Protocol - Transport Layer Security). The certificates are provided by a **Certification Authority (CA)**. You need:

- a CA certificate to authenticate the authentication server
- a CA-signed client certificate to authenticate the Axis product.

To create and install certificates, go to **System Options > Security > Certificates**. See *Certificates*, on page 43. Many CA certificates are preinstalled.

To allow the product to access a network protected by IEEE 802.1X:

1. Go to **System Options > Security > IEEE 802.1X**.
2. Select a **CA Certificate** and a **Client Certificate** from the lists of installed certificates.
3. Under **Settings**, select the EAPOL version and provide the EAP identity associated with the client certificate.
4. Check the box to enable IEEE 802.1X and click **Save**.

Note

For authentication to work properly, the date and time settings in the Axis product should be synchronized with an NTP server. See *Date & Time*, on page 44.

Certificates

Certificates are used to authenticate devices on a network. Typical applications include encrypted web browsing (HTTPS), network protection via IEEE 802.1X and secure upload of images and notification messages for example via email. Two types of certificates can be used with the Axis product:

Server/Client certificates – to authenticate the Axis product

CA certificates – to authenticate peer certificates, for example the certificate of an authentication server in case the Axis product is connected to an IEEE 802.1X protected network.

Note

Installed certificates, except preinstalled CA certificates, will be deleted if the product is reset to factory default. Preinstalled CA certificates that have been deleted will be reinstalled.

A **Server/Client** certificate can be self-signed or issued by a Certificate Authority (CA). A self-signed certificate offers limited protection and can be used before a CA-issued certificate has been obtained.

AXIS P5414–E PTZ Dome Network Camera

System Options

To install a self-signed certificate:

1. Go to **System Options > Security > Certificates**.
2. Click **Create self-signed certificate** and provide the requested information.

To create and install a CA-signed certificate:

1. Create a self-signed certificate as described above.
2. Go to **System Options > Security > Certificates**.
3. Click **Create certificate signing request** and provide the requested information.
4. Copy the PEM-formatted request and send to the CA of your choice.
5. When the signed certificate is returned, click **Install certificate** and upload the certificate.

Server/Client certificates can be installed as **Certificate from signing request** or as **Certificate and private key**. Select **Certificate and private key** if the private key is to be upload as a separate file or if the certificate is in PKCS#12 format.

The Axis product is shipped with several preinstalled CA certificates. If required, additional CA certificates can be installed:

1. Go to **System Options > Security > Certificates**
2. Click **Install certificate** and upload the certificate.

Audio Support

Select **Enable audio support** to allow clients to retrieve audio streams from the Axis product. For information on how to configure audio settings, see *Audio Settings, on page 22*.

Note

Deselecting this option will disable audio globally in the Axis product, for configured events and profiles with audio as well.

Date & Time

The Axis product's date and time settings are configured under **System Options > Date & Time**.

Current Server Time displays the current date and time (24h clock). The time can be displayed in 12h clock in the text overlay (see below).

To change the date and time settings, select the preferred **Time mode** under **New Server Time**:

- **Synchronize with computer time** sets date and time according to the computer's clock. With this option, date and time are set once and will not be updated automatically.
- **Synchronize with NTP Server** obtains date and time from an NTP server. With this option, date and time settings are updated continuously. For information on NTP settings, see *NTP Configuration, on page 47*.
If using a host name for the NTP server, a DNS server must be configured. See *DNS Configuration, on page 46*.
- **Set manually** allows you to manually set date and time.

If using an NTP server, select your **Time zone** from the drop-down list. If required, check **Automatically adjust for daylight saving time changes**.

The **Date & Time Format Used in Images** is the date and time format displayed as a text overlay in the video stream. Use the predefined formats or see *File Naming & Date/Time Formats* in the online help  for information on how to create custom date and time formats. To include date and time in the overlay text, go to **Video & Audio** and select **Include date** and **Include time**.

AXIS P5414–E PTZ Dome Network Camera

System Options

Network

Basic TCP/IP Settings

The Axis product supports IP version 4 and IP version 6. Both versions can be enabled simultaneously, and at least one version must always be enabled.

IPv4 Address Configuration

By default, the Axis product is set to use IPv4 (IP version 4) and to obtain the IP address automatically via DHCP. The IPv4 settings are configured under **System Options > Network > TCP/IP > Basic**.

DHCP (Dynamic Host Configuration Protocol) allows network administrators to centrally manage and automate the assignment of IP addresses. DHCP should only be enabled if using dynamic IP address notification, or if the DHCP can update a DNS server. It is then possible to access the Axis product by name (host name).

If DHCP is enabled and the product cannot be accessed, run **AXIS IP Utility** to search the network for connected Axis products, or reset the product to the factory default settings (see *page 53*) and then perform the installation again.

To use a static IP address, check **Use the following IP address** and specify the IP address, subnet mask and default router.

IPv6 Address Configuration

If IPv6 (IP version 6) is enabled, the Axis product will receive an IP address according to the configuration in the network router.

To enable IPv6, go to **System Options > Network > TCP/IP > Basic**. Other settings for IPv6 should be configured in the network router.

ARP/Ping

The product's IP address can be assigned using ARP and Ping. For instructions, see *Assign IP Address Using ARP/Ping, on page 45*.

The ARP/Ping service is enabled by default but is automatically disabled two minutes after the product is started, or as soon as an IP address is assigned. To re-assign IP address using ARP/Ping, the product must be restarted to enable ARP/Ping for an additional two minutes.

To disable the service, go to **System Options > Network > TCP/IP > Basic** and clear the option **Enable ARP/Ping setting of IP address**.

Pinging the product is still possible when the service is disabled.

Assign IP Address Using ARP/Ping

The product's IP address can be assigned using ARP/Ping. The command must be issued within 2 minutes of connecting power.

1. Acquire a free static IP address on the same network segment as the computer.
2. Locate the serial number (S/N) on the product label.
3. Open a command prompt and enter the following commands:

Linux/Unix syntax

```
arp -s <IP address> <serial number> temp  
ping -l 408 <IP address>
```

Linux/Unix example

```
arp -s 192.168.0.125 00:40:8c:18:10:00 temp  
ping -l 408 192.168.0.125
```

Windows syntax (this may require that you run the command prompt as an administrator)

```
arp -s <IP address> <serial number>
```

AXIS P5414–E PTZ Dome Network Camera

System Options

```
ping -l 408 -t <IP address>
```

Windows example (this may require that you run the command prompt as an administrator)

```
arp -s 192.168.0.125 00-40-8c-18-10-00  
ping -l 408 -t 192.168.0.125
```

4. Check that the network cable is connected and then restart the product by disconnecting and reconnecting power.
5. Close the command prompt when the product responds with `Reply from 192.168.0.125: . . .` or similar.
6. Open a browser and type `http://<IP address>` in the Location/Address field.

For other methods of assigning the IP address, see the Installation and Management Software CD or the document *Assign an IP Address and Access the Video Stream* on Axis Support web at www.axis.com/techsup

Note

- To open a command prompt in Windows, open the **Start menu** and type `cmd` in the **Run/Search** field.
- To use the ARP command in Windows 7/Windows Vista, right-click the command prompt icon and select **Run as administrator**.
- To open a command prompt in Mac OS X, open the **Terminal utility** from **Application > Utilities**.

AXIS Video Hosting System (AVHS)

AVHS used in conjunction with an AVHS service, provides easy and secure Internet access to live and recorded video accessible from any location. For more information and help to find a local AVHS Service Provider go to www.axis.com/hosting

The AVHS settings are configured under **System Options > Network > TCP/IP > Basic**. The possibility to connect to an AVHS service is enabled by default. To disable, clear the **Enable AVHS** box.

One-click enabled – Press the product's control button (see *Hardware Overview, on page 6*) to connect to an AVHS service over the Internet. Once registered, **Always** will be enabled and the Axis product stays connected to the AVHS service. If the product is not registered within 24 hours from when the button is pressed, the product will disconnect from the AVHS service.

Always – The Axis product will constantly attempt to connect to the AVHS service over the Internet. Once registered the product will stay connected to the service. This option can be used when the product is already installed and it is not convenient to use the one-click installation.

AXIS Internet Dynamic DNS Service

AXIS Internet Dynamic DNS Service assigns a host name for easy access to the product. For more information, see www.axiscam.net

To register the Axis product with AXIS Internet Dynamic DNS Service, go to **System Options > Network > TCP/IP > Basic**. Under **Services**, click the **AXIS Internet Dynamic DNS Service Settings** button (requires access to the Internet). The domain name currently registered at AXIS Internet Dynamic DNS service for the product can at any time be removed.

Advanced TCP/IP Settings

DNS Configuration

DNS (Domain Name Service) provides the translation of host names to IP addresses. The DNS settings are configured under **System Options > Network > TCP/IP > Advanced**.

Select **Obtain DNS server address via DHCP** to use the DNS settings provided by the DHCP server.

To make manual settings, select **Use the following DNS server address** and specify the following:

Domain name – Enter the domain(s) to search for the host name used by the Axis product. Multiple domains can be separated by semicolons. The host name is always the first part of a fully qualified domain name, for example, `myserver` is the host name in the fully qualified domain name `myserver.mycompany.com` where `mycompany.com` is the domain name.

AXIS P5414–E PTZ Dome Network Camera

System Options

Primary/Secondary DNS server – Enter the IP addresses of the primary and secondary DNS servers. The secondary DNS server is optional and will be used if the primary is unavailable.

NTP Configuration

NTP (Network Time Protocol) is used to synchronize the clock times of devices in a network. The NTP settings are configured under **System Options > Network > TCP/IP > Advanced**.

Select **Obtain NTP server address via DHCP** to use the NTP settings provided by the DHCP server.

To make manual settings, select **Use the following NTP server address** and enter the host name or IP address of the NTP server.

Host Name Configuration

The Axis product can be accessed using a host name instead of an IP address. The host name is usually the same as the assigned DNS name. The host name is configured under **System Options > Network > TCP/IP > Advanced**.

Select **Obtain host name via IPv4 DHCP** to use host name provided by the DHCP server running on IPv4.

Select **Use the host name** to set the host name manually.

Select **Enable dynamic DNS updates** to dynamically update local DNS servers whenever the Axis product's IP address changes.

For more information, see the online help .

Link-Local IPv4 Address

Link-Local Address is enabled by default and assigns the Axis product an additional IP address which can be used to access the product from other hosts on the same segment on the local network. The product can have a Link-Local IP and a static or DHCP-supplied IP address at the same time.

This function can be disabled under **System Options > Network > TCP/IP > Advanced**.

HTTP

The HTTP port used by the Axis product can be changed under **System Options > Network > TCP/IP > Advanced**. In addition to the default setting, which is 80, any port in the range 1024–65535 can be used.

HTTPS

The HTTPS port used by the Axis product can be changed under **System Options > Network > TCP/IP > Advanced**. In addition to the default setting, which is 443, any port in the range 1024–65535 can be used.

To enable HTTPS, go to **System Options > Security > HTTPS**. For more information, see *HTTPS*, on page 42.

NAT traversal (port mapping) for IPv4

A network router allows devices on a private network (LAN) to share a single connection to the Internet. This is done by forwarding network traffic from the private network to the "outside", that is, the Internet. Security on the private network (LAN) is increased since most routers are pre-configured to stop attempts to access the private network (LAN) from the public network (Internet).

Use **NAT traversal** when the Axis product is located on an intranet (LAN) and you wish to make it available from the other (WAN) side of a NAT router. With NAT traversal properly configured, all HTTP traffic to an external HTTP port in the NAT router is forwarded to the product.

NAT traversal is configured under **System Options > Network > TCP/IP > Advanced**.

Note

- For NAT traversal to work, this must be supported by the router. The router must also support UPnP™.
- The router has many different names: "NAT router", "Network router", "Internet Gateway", "Broadband router", "Broadband sharing device" or "Home firewall" but the essential purpose of the device is the same.

AXIS P5414–E PTZ Dome Network Camera

System Options

Enable/Disable – When enabled, the Axis product attempts to configure port mapping in a NAT router on your network, using UPnP™. Note that UPnP™ must be enabled in the product (see **System Options > Network > UPnP**).

Use manually selected NAT router – Select this option to manually select a NAT router and enter the IP address for the router in the field. If no router is specified, the product automatically searches for NAT routers on your network. If more than one router is found, the default router is selected.

Alternative HTTP port – Select this option to manually define an external HTTP port. Enter the port number in the field. If no port is entered here, a port number is automatically selected when NAT traversal is enabled.

Note

- An alternative HTTP port can be used or be active even if NAT traversal is disabled. This is useful if your NAT router does not support UPnP and you need to manually configure port forwarding in the NAT router.
- If you attempt to manually enter a port that is already in use, another available port is automatically selected.
- When the port is selected automatically it is displayed in this field. To change this, enter a new port number and click **Save**.

FTP

The FTP server running in the Axis product enables upload of new firmware, user applications, etc. The FTP server can be disabled under **System Options > Network > TCP/IP > Advanced**.

Note

This FTP server has nothing to do with the product's ability to transfer images via FTP to other locations and servers.

RTSP

The RTSP server running in the Axis product allows a connecting client to start an H.264 stream. The RTSP port number can be changed under **System Options > Network > TCP/IP > Advanced**. The default port is 554.

Note

H.264 video streams will not be available if the RTSP server is disabled.

SOCKS

SOCKS is a networking proxy protocol. The Axis product can be configured to use a SOCKS server to reach networks on the other side of a firewall or proxy server. This functionality is useful if the Axis product is located on a local network behind a firewall, and notifications, uploads, alarms, etc need to be sent to a destination outside the local network (for example the Internet).

SOCKS is configured under **System Options > Network > SOCKS**. For more information, see the online help .

QoS (Quality of Service)

QoS (Quality of Service) guarantees a certain level of a specified resource to selected traffic on a network. A QoS-aware network prioritizes network traffic and provides a greater network reliability by controlling the amount of bandwidth an application may use.

The QoS settings are configured under **System Options > Network > QoS**. Using DSCP (Differentiated Services Codepoint) values, the Axis product can mark the following types of traffic: live video, live audio, event/alarm traffic and management traffic.

Note

Live audio DSCP will be equal to live video DSCP if H.264 over RTSP is used.

SMTP (email)

To send email messages from the Axis product via SMTP (Simple Mail Transfer Protocol), an SMTP mail server must be set up. This is done under **System Options > Network > SMTP (email)**.

AXIS P5414–E PTZ Dome Network Camera

System Options

Enter the host names or IP addresses and port numbers for the primary and secondary mail servers in the fields provided. A **From email address** is also required. If the mail server requires authentication, check **Use authentication to log in to this server** and enter the necessary information.

SNMP

The Simple Network Management Protocol (SNMP) allows remote management of network devices. An SNMP community is the group of devices and management station running SNMP. Community names are used to identify groups.

The Axis product can be configured to support SNMP on the **System Options > Network > SNMP** page.

Depending on the level of security required, select the version on SNMP to use.

SNMP v1/v2 provides the lowest level of security. The community name can be specified as a password for read or read/write access to all supported SNMP devices. The default password for the **Read community** is public and the default password for the **Write community** is write.

Note

If HTTPS is enabled, SNMP v1 and SNMP v2c should be disabled.

Traps for SNMP v1/v2 are used by the Axis product to send messages to a management system on important events and status changes. Check **Enable traps** and enter the IP address where the trap message should be sent and the **Trap community** that should receive the message.

The following traps are available:

- Cold start
- Warm start
- Link up
- Authentication failed

SNMP v3 provides encryption and secure passwords. To use traps with SNMP v3, an SNMP v3 management application is required.

To use SNMP v3, HTTPS must be enabled, see *HTTPS, on page 42*. To enable SNMP v3, check the box and provide the initial user password.

Note

The initial password can only be set once. If the password is lost, the Axis product must be reset to factory default, see *Reset to Factory Default Settings, on page 53*.

UPnP™

The Axis product includes support for UPnP™. UPnP™ is enabled by default and the product is automatically detected by operating systems and clients that support this protocol.

UPnP™ can be disabled under **System Options > Network > UPnP™**.

RTP/H.264

The RTP port range and multicast settings are configured under **System Options > Network > RTP**.

The RTP port range defines the range of ports from which the video/audio ports are automatically selected. For multicast streams, only certain IP addresses and port numbers should be used.

Select **Always Multicast Video** and/or **Always Multicast Audio** to start multicast streaming without opening an RTSP session.

AXIS P5414–E PTZ Dome Network Camera

System Options

Bonjour

The Axis product includes support for Bonjour. Bonjour is enabled by default and the product is automatically detected by operating systems and clients that support this protocol.

Bonjour can be disabled under **System Options > Network > Bonjour**.

Storage

SD Card

The Axis product supports SD cards with up to 64 GB of storage. For best recording performance, use an SDHC or SDXC card with speed class 10.

NOTICE

To prevent corruption of recordings, the SD card should always be unmounted before it is ejected.

The Axis product supports SD cards with the following file systems:

- **ext4** — recommended due to its resilience against data loss if the card is ejected or if there is abrupt power loss. To access data stored on the card from the Windows operating system, a third-party ext4 driver or application is required.
- **vFAT** — most SD cards are pre-formatted with vFAT when purchased.

If required, the SD card can be manually formatted to the desired file system. To format the SD card:

1. Insert the SD card in the SD card slot.
2. Go to **System Options > Storage** and click **SD Card**.
3. Click **Format** and select the desired file system.

Note

During formatting any previous data stored on the disk will be lost.

Mounting is done automatically when the card is inserted or when the product is started. A manual mount is only required if the card has been unmounted and not ejected and re-inserted.

To unmount the SD card:

1. Go to **System Options > Storage** and click **SD Card**.
2. Click **Unmount**.
3. The card can now be removed.

The SD card is managed on the **System Options > Storage** page. Click **SD Card** to open **Storage Management**.

If the card's status shows as failed, click **Check disk** to see if the problem can be found and then try **Repair**. This option is only available for SD cards with ext4. For SD cards with vFAT, use a card reader or computer to troubleshoot the card.

To avoid filling the card, it is recommended to remove recordings continuously. Under **Recording Settings**, select **Remove recordings older than** and select the number of days or weeks.

To stop writing to the card and protect recordings from being removed, select **Lock** under **Recording Settings**.

Network Share

Network share allows you to add network storage such as a NAS (Network Attached Storage) or any server that uses CIFS (Common Internet File System) and use them for storage of recordings.

AXIS P5414–E PTZ Dome Network Camera

System Options

To add a network share:

1. Go to **System Options > Storage**.
2. Click **Network Share**.
3. Enter the IP address, DNS or Bonjour name to the host server in the **Host** field.
4. Enter the name of the share in the **Share** field. Sub folders cannot be used.
5. If required, select **The share requires login** and enter the user name and password.
6. Click **Connect**.

To clear all recordings and data from the Axis product's folder on the designated share, click **Clear** under **Storage Tools**.

To avoid filling the share, it is recommended to remove recordings continuously. Under **Recording Settings**, select **Remove recordings older than** and select the number of days or weeks.

To stop writing to the share and protect recordings from being removed, select **Lock** under **Recording Settings**.

Ports & Devices

I/O Ports

The Axis product provides four configurable input and output ports for connection of external devices. For information about how to connect external devices, see *Connectors, on page 61*.

The I/O ports are configured under **System Options > Ports & Devices > I/O Ports**. Select the port direction (**Input** or **Output**). The ports can be given descriptive names and their **Normal** states can be configured as **Open circuit** or **Grounded circuit**.

Port Status

The list on the **System Options > Ports & Devices > Port Status** page shows the status of the product's input and output ports.

Maintenance

The Axis product provides several maintenance functions. These are available under **System Options > Maintenance**.

Click **Restart** to perform a correct restart if the Axis product is not behaving as expected. This will not affect any of the current settings.

Click **Restore** to reset most settings to the factory default values. The following settings are not affected:

- the boot protocol (DHCP or static)
- the static IP address
- the default router
- the subnet mask
- the system time
- the IEEE 802.1X settings
- uploaded applications are kept but must be restarted

Click **Default** to reset all settings, including the IP address, to the factory default values. This button should be used with caution. The Axis product can also be reset to factory default using the control button, see *Reset to Factory Default Settings, on page 53*.

To test the product's PTZ mechanics, click **Test** under **PTZ Status**.

AXIS P5414–E PTZ Dome Network Camera

System Options

For information about firmware upgrade, see *Upgrading the Firmware, on page 55*.

Support

Support Overview

The **System Options > Support > Support Overview** page provides information on troubleshooting and contact information, should you require technical assistance.

See also *Troubleshooting, on page 55*.

System Overview

To get an overview of the Axis product's status and settings, go to **System Options > Support > System Overview**. Information that can be found here includes firmware version, IP address, network and security settings, event settings, image settings and recent log items. Many of the captions are links to the proper Setup page.

Logs & Reports

The **System Options > Support > Logs & Reports** page generates logs and reports useful for system analysis and troubleshooting. If contacting Axis Support, please provide a valid Server Report with your query.

System Log – Provides information about system events.

Access Log – Lists all failed attempts to access the product. The Access Log can also be configured to list all connections to the product (see below).

Server Report – Provides information about the product status in a pop-up window. The Access Log is automatically included in the Server Report.

You can view or download the server report. Downloading the server report creates a .zip file that contains a complete server report text file in UTF-8 format. Select the **Include snapshot with default image settings** option to include a snapshot of the product's Live View that also shows the settings specified under **Video Stream>Image>Image Appearance**. The server report .zip file should always be included when contacting support.

Parameter List – Shows the product's parameters and their current settings. This may prove useful when troubleshooting or when contacting Axis Support.

Connection List – Lists all clients that are currently accessing media streams.

Crash Report – Generates an archive with debugging information. The report takes several minutes to generate.

The log levels for the System Log and the Access Log are set under **System Options > Support > Logs & Reports > Configuration**. The Access Log can be configured to list all connections to the product (select Critical, Warnings & Info).

Advanced

Scripting

Scripting allows experienced users to customize and use their own scripts.

NOTICE

Improper use may cause unexpected behavior and loss of contact with the Axis product.

Axis strongly recommends that you do not use this function unless you understand the consequences. Axis Support does not provide assistance for problems with customized scripts.

AXIS P5414–E PTZ Dome Network Camera

System Options

To open the Script Editor, go to **System Options > Advanced > Scripting**. If a script causes problems, reset the product to its factory default settings, see *page 53*.

For more information, see www.axis.com/developer

File Upload

Files, for example web pages and images, can be uploaded to the Axis product and used as custom settings. To upload a file, go to **System Options > Advanced > File Upload**.

Uploaded files are accessed through `http://<ip address>/local/<user>/<file name>` where `<user>` is the selected user group (viewer, operator or administrator) for the uploaded file.

Plain Config

Plain Config is for advanced users with experience of Axis product configuration. Most parameters can be set and modified from this page. Help is available from the standard help pages.

To open Plain Config, go to **System Options > Advanced > Plain Config**. Axis Support does not provide assistance.

Reset to Factory Default Settings

Important

Reset to factory default should be used with caution. A reset to factory default will reset all settings, including the IP address, to the factory default values.

Note

The installation and management software tools are available on the CD supplied with the product and from the support pages on www.axis.com/techsup

To reset the product to the factory default settings:

1. Disconnect power from the product.
2. Press and hold the control button and reconnect power. See *Hardware Overview, on page 6*.
3. Keep the control button pressed for about 15–30 seconds until the status LED indicator flashes amber.
4. Release the control button. The process is complete when the status LED indicator turns green. The product has been reset to the factory default settings. If no DHCP server is available on the network, the default IP address is 192.168.0.90
5. Using the installation and management software tools, assign an IP address, set the password, and access the video stream.

It is also possible to reset parameters to factory default via the web interface. Go to **Setup > System Options > Maintenance**.

AXIS P5414-E PTZ Dome Network Camera

Repainting the Camera

Repainting the Camera

The covers can be repainted to match the installation environment.

The material used in the covers is ASA Geloy XTWM206. Use paint suitable for this material.

1. Remove the two top cover screws.
2. Use a thin palette knife to release the locking tabs while pulling the top cover straight upwards to remove the cover.
3. Remove the two bottom cover screws and remove the bottom cover.
4. Mask the locking tabs in the bottom cover and the three screw covers.
5. Repaint the top cover, the bottom cover, the screw covers, and the conduit cover.
6. Assemble in the reverse order.

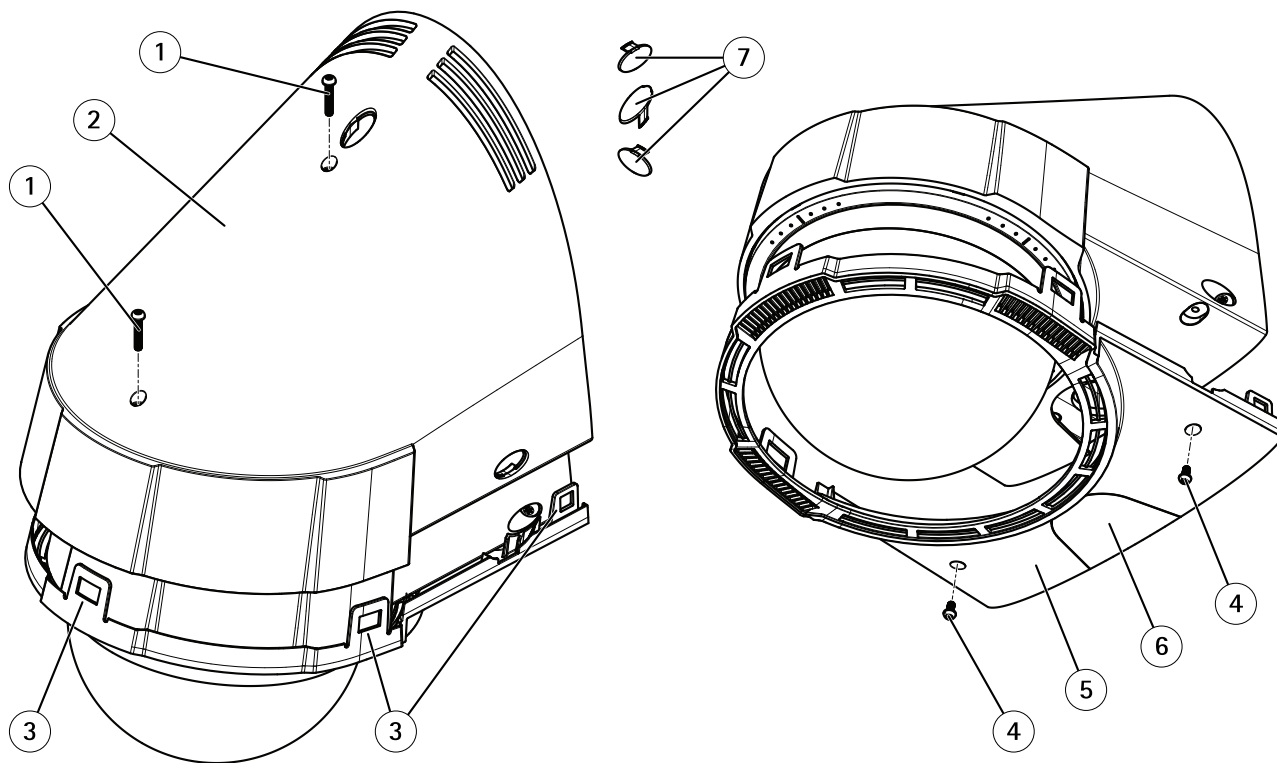

- 1 Top cover screw
- 2 Top cover
- 3 Locking tab
- 4 Bottom cover screw
- 5 Bottom cover
- 6 Conduit cover
- 7 Screw cover

AXIS P5414-E PTZ Dome Network Camera

Troubleshooting

Troubleshooting

Checking the Firmware

Firmware is software that determines the functionality of network devices. One of your first actions when troubleshooting a problem should be to check the current firmware version. The latest version may contain a correction that fixes your particular problem. The current firmware version in the Axis product is displayed in the page **Setup > Basic Setup** and in **Setup > About**.

Upgrading the Firmware

When you upgrade the > with the latest firmware from Axis website, the product receives the latest functionality available. Always read the upgrade instructions and release notes available with each new release, before upgrading the firmware.

To upgrade, follow these instructions:

1. Save the firmware file to your computer. The latest version of the firmware is available free of charge from Axis website at www.axis.com/techsup
2. Go to **Setup > System Options > Maintenance** in the product's web pages.
3. Under **Upgrade Server**, click **Browse** and locate the file on your computer. Click **Upgrade**.

After starting the upgrade process, always wait at least 5–10 minutes before restarting the product, even if you suspect the upgrade has failed.

AXIS Camera Management can be used for multiple upgrades. See www.axis.com for more information.

Note

- Your dealer reserves the right to charge for any repair attributable to faulty upgrade by the user.
- Preconfigured and customized settings are saved when the firmware is upgraded (providing the features are available in the new firmware) although this is not guaranteed by Axis Communications AB.

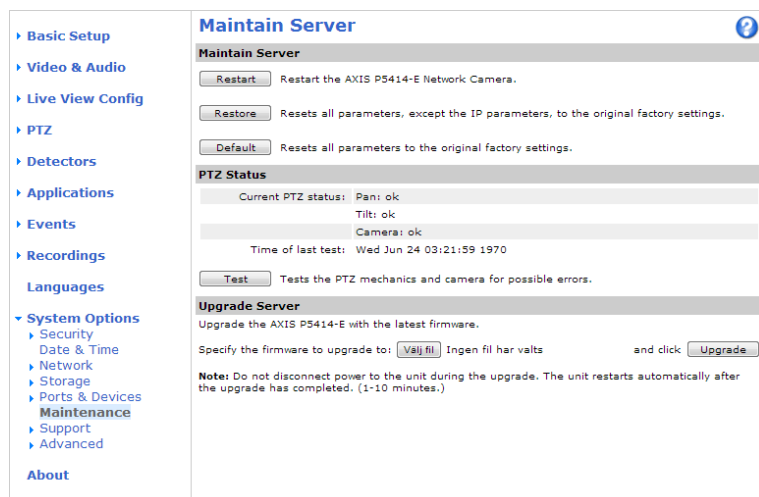

Emergency Recovery Procedure

If power or network connection is lost during the upgrade, the process fails and the product becomes unresponsive. Flashing red Status indicator indicates a failed upgrade. To recover the product, follow the steps below. The serial number is found on the product's label.

1. In UNIX/Linux, type the following from the command line:

AXIS P5414–E PTZ Dome Network Camera

Troubleshooting

```
arp -s <IP address> <serial number> temp  
ping -l 408 <IP address>
```

In **Windows**, type the following from a command/DOS prompt (this may require that you run the command prompt as an administrator):

```
arp -s <IP address> <serial number>  
ping -l 408 -t <IP address>
```

2. If the product does not reply in 30 seconds, restart it and wait for a reply. Press CTRL+C to stop Ping.
3. Open a browser and type in the product's IP address. In the page that appears, use the **Browse** button to select the upgrade file to use. Then click **Load** to restart the upgrade process.
4. After the upgrade is complete (1–10 minutes), the product automatically restarts and shows a steady green on the Status indicator.
5. Reinstall the product, referring to the Installation Guide.

If the emergency recovery procedure does not get the product up and running again, contact Axis support at www.axis.com/techsup/

Symptoms, Possible Causes and Remedial Actions

Problems setting the IP address

When using ARP/Ping	Try the installation again. The IP address must be set within two minutes after power has been applied to the product. Ensure the Ping length is set to 408. For instructions, see <i>Assign IP Address Using ARP/Ping</i> , on page 45.
The product is located on a different subnet	If the IP address intended for the product and the IP address of the computer used to access the product are located on different subnets, you will not be able to set the IP address. Contact your network administrator to obtain an IP address.
The IP address is being used by another device	Disconnect the Axis product from the network. Run the Ping command (in a Command/DOS window, type <code>ping</code> and the IP address of the product): <ul style="list-style-type: none">• If you receive: <code>Reply from <IP address>: bytes=32; time=10...</code> this means that the IP address may already be in use by another device on the network. Obtain a new IP address from the network administrator and reinstall the product.• If you receive: <code>Request timed out</code>, this means that the IP address is available for use with the Axis product. Check all cabling and reinstall the product.
Possible IP address conflict with another device on the same subnet.	The static IP address in the Axis product is used before the DHCP server sets a dynamic address. This means that if the same default static IP address is also used by another device, there may be problems accessing the product.

The product cannot be accessed from a browser

Cannot log in	When HTTPS is enabled, ensure that the correct protocol (HTTP or HTTPS) is used when attempting to log in. You may need to manually type <code>http</code> or <code>https</code> in the browser's address field. If the password for the user <code>root</code> is lost, the product must be reset to the factory default settings. See <i>Reset to Factory Default Settings</i> , on page 53.
---------------	---

AXIS P5414–E PTZ Dome Network Camera

Troubleshooting

The IP address has been changed by DHCP	IP addresses obtained from a DHCP server are dynamic and may change. If the IP address has been changed, use AXIS IP Utility or AXIS Camera Management to locate the product on the network. Identify the product using its model or serial number, or by the DNS name (if the name has been configured). If required, a static IP address can be assigned manually. For instructions, see the Installation and Management Software CD or the document <i>Assign an IP Address and Access the Video Stream</i> on Axis Support web at www.axis.com/techsup .
Certificate error when using IEEE 802.1X	For authentication to work properly, the date and time settings in the Axis product should be synchronized with an NTP server. See <i>Date & Time</i> , on page 44.

The product is accessible locally but not externally

Router configuration	To configure your router to allow incoming data traffic to the Axis product, enable the NAT-traversal feature which will attempt to automatically configure the router to allow access to the Axis product, see <i>NAT traversal (port mapping) for IPv4</i> , on page 47. The router must support UPnP™.
Firewall protection	Check the Internet firewall with your network administrator.
Default routers required	Check if you need to configure the router settings from System Options > Network > TCP/IP > Basic .

Problems with streaming H.264

Problems with AXIS Media Control (<i>Internet Explorer only</i>)	To enable the updating of video images in Internet Explorer, set the browser to allow ActiveX controls. Also, make sure that AXIS Media Control is installed on your computer.
No H.264 displayed in the client	Check that the relevant H.264 connection methods and correct interface are enabled in the AMC Control Panel (streaming tab). See <i>AXIS Media Control (AMC)</i> , on page 13. In the AMC Control Panel, select the H.264 tab and click Set to default H.264 decoder . Check that RTSP is enabled under System Options > Network > TCP/IP > Advanced .
Multicast H.264 only accessible by local clients	Check if your router supports multicasting, or if the router settings between the client and the product need to be configured. The TTL (Time To Live) value may need to be increased.
No multicast H.264 displayed in the client	Check with your network administrator that the multicast addresses used by the Axis product are valid for your network. Check with your network administrator to see if there is a firewall preventing viewing.
Installation of additional ActiveX component restricted or prohibited	Configure the Axis product to use a Java applet for updating video images in your browser. Go to Setup > Live View Config and select Java applet under Default viewer .
Poor rendering of H.264 images	Ensure that your graphics card is using the latest driver. The latest drivers can usually be downloaded from the manufacturer's website.
Color saturation is different in H.264 and Motion JPEG	Modify the settings for your graphics adapter. Refer to the adapter's documentation for more information.

AXIS P5414–E PTZ Dome Network Camera

Troubleshooting

Lower frame rate than expected	<p>See <i>Performance Considerations</i>, on page 63.</p> <p>Reduce the number of applications running on the client computer.</p> <p>Limit the number of simultaneous viewers.</p> <p>Check with the network administrator that there is enough bandwidth available.</p> <p>Check in the AMC Control Panel (H.264 tag) that video processing is NOT set to Decode only key frames.</p> <p>Lower the image resolution.</p> <p>The maximum frames per second is dependent on the utility frequency (60/50 Hz) of the Axis product. See <i>Technical Specifications</i>, on page 59.</p>
--------------------------------	---

Video and image problems, general

Image unsatisfactory	Check the video stream and camera settings under Setup > Video & Audio > Video Stream and Setup > Video & Audio > Camera Settings .
----------------------	---

Motion Detection triggers unexpectedly

Changes in luminance	Motion detection is based on changes in luminance in the image. This means that if there are sudden changes in the lighting, motion detection may trigger mistakenly. Lower the sensitivity setting to avoid problems with luminance.
----------------------	---

No audio

Incorrect setup	<p>Check the sound card in the computer. Ensure that mute is not selected and that the volume settings are correct.</p> <p>Check that Enable audio support is selected under Setup > System Options > Security > Audio Support.</p> <p>Check that the correct Audio Input source is selected under Setup > Video & Audio > Audio Settings.</p>
-----------------	---

Poor audio quality

Stuttering	Reduce the number of listeners and viewers. Decrease image resolution and compression.
Unsynchronized audio and video using H.264	Synchronize the product's date and time settings with an NTP server. Go to Setup > System Options > Date & Time .
Distorted audio	Check that the correct Audio Input source is selected under Setup > Video & Audio > Audio Settings .
Feedback loops	Feedback loops might appear in full-duplex mode. Try moving the microphone or the speaker, or use half-duplex mode instead.

Storage and disk management problems

Storage disruption	<p>A storage disruption alarm is sent if a storage device is unavailable, removed, full, locked or if other read or write problems occur. To identify the source of the problem, check the System Log under System Options > Support > Logs & Reports. Depending on the problem, it might be necessary to re-mount the storage device.</p> <p>For information on how to set up a storage disruption alarm, see <i>Events</i>, on page 35.</p>
Video cannot be recorded	Check that the SD card is not write protected (that is, read only).
SD card cannot be mounted	Reformat the SD card and then click Mount.

AXIS P5414–E PTZ Dome Network Camera

Technical Specifications

Technical Specifications

Function/group	Item	Specifications
Camera	Models	AXIS P5414–E 50 Hz AXIS P5414–E 60 Hz
	Image sensor	1/2.9" progressive scan RGB CMOS
	Lens	f=4.7 mm – 84.6 mm F1.6 – 2.8 Autofocus Automatic day and night functionality Horizontal angle of view: 59° – 4°
	Minimum illumination	Color: 0.4 lux at 30 IRE F1.6 B/W: 0.04 lux at 30 IRE F1.6
	Shutter time	1/28000 s to 2 s
	Pan/Tilt/Zoom	Pan $\pm 135^\circ$, 0.2 – 350°/s* Tilt: 0 – 90°, 0.2 – 350°/s 18x optical zoom and 12x digital zoom, total 216x zoom 100 preset positions * There is slight visual obstruction from the housing in the upper left/right corner of the image at pan end points.
	Pan/Tilt/Zoom functionalities	Guard tour, control queue, focus window, on-screen directional indicator
Video	Video compression	H.264 Main and Baseline profile (MPEG-4 Part 10/AVC) Motion JPEG
	Resolutions	1280x720 to 240x135
	Frame rate H.264	Up to 30/25 (60/50 Hz) in all resolutions
	Frame rate Motion JPEG	Up to 30/25 (60/50 Hz) in all resolutions
	Video streaming	Multiple, individually configurable streams in H.264 and Motion JPEG Controllable frame rate and bandwidth VBR/CBR H.264
	Image settings	Wide Dynamic Range (WDR), Compression, Color, Brightness, Sharpness, Contrast, White balance, Exposure control, Exposure zones, Backlight compensation, Fine tuning of behavior at low light, Text and image overlay, 20 individual 3D privacy masks
Audio	Audio streaming	Two-way
	Audio compression	AAC LC 8/16 kHz G.711 PCM 8 kHz G.726 ADPCM 8 kHz Configurable bit rate
	Audio input/output	External microphone or line input, and line output

AXIS P5414–E PTZ Dome Network Camera

Technical Specifications

Function/group	Item	Specifications
Network	Security	Password protection, IP address filtering, HTTPS encryption*, IEEE 802.1X network access control*, digest authentication, user access log *This product includes software developed by the Open SSL Project for use in the Open SSL Toolkit (www.openssl.org)
	Supported protocols	IPv4/v6, HTTP, HTTPS*, SSL/TLS*, QoS Layer 3 DiffServ, FTP, CIFS/SMB, SMTP, Bonjour, UPnP, SNMPv1/v2c/v3(MIB-II), DNS, DynDNS, NTP, RTSP, RTP, TCP, UDP, IGMP, RTCP, ICMP, DHCP, ARP, SOCKS, etc *This product includes software developed by the Open SSL Project for use in the Open SSL Toolkit (www.openssl.org)
System Integration	Application Programming Interface	Open API for software integration, including VAPIX® and AXIS Camera Application Platform from Axis Communications; specifications available at www.axis.com AXIS Video Hosting System (AVHS) with One-Click Camera Connection ONVIF Profile S, specifications available at www.onvif.org
	Intelligent video	Video motion detection, Advanced Gatekeeper, Support for AXIS Camera Application Platform enabling installation of additional applications
	Event triggers	Video motion detection, audio detection, external input, PTZ preset, temperature, memory card full
	Event actions	File upload via FTP, HTTP, network share and email Notification via email, HTTP and TCP External output activation Go to PTZ preset Run guard tour Record to local storage Play audio clip Day/night mode
	Video buffer	80 MB pre- and post alarm
	Video access from web browser	Camera live view Video recording to file (ASF) Customizable HTML pages Windows 7, Windows Vista, Windows XP, Windows Server 2008, Windows Server 2003 DirectX 9c or higher For other operating systems and browsers, see www.axis.com/techsup
	Installation, management and maintenance	AXIS Camera Management tool on CD and web-based configuration Configuration of backup and restore Firmware upgrades over HTTP or FTP, firmware available on www.axis.com

AXIS P5414–E PTZ Dome Network Camera

Technical Specifications

Function/group	Item	Specifications
General	Casing	IP66– and NEMA 4X–rated metal casing (aluminum), clear dome (PC), sunshield (ASA)
	memory	256MB RAM, 128 MB Flash
	Power	Power over Ethernet Plus (PoE+) IEEE 802.3at Type 2 Class 4, max 30W 20–28 V DC max 16 W
	Connectors	RJ-45 for 10BASE-T/100BASE-TX PoE Terminal block for DC input Terminal block for 4 configurable alarm inputs and outputs Terminal block for mic/lin input and line output
	Local storage	Supports SD cards with up to 64 GB of storage. For best recording performance, use an SDHC or SDXC card with speed class 10. (card not included) Support for recording to network share (Network Attached Storage or file server)
	Operating conditions	Temperature: –20 °C to 50 °C (–4 °F to 122 °F) Humidity 10–100% RH (condensing)
	Approvals	EN 50121–4, IEC 62236–4, EN 55022 Class B, EN 61000–6–1, EN 61000–6–2, EN 55024, FCC Part 15 Subpart B Class B, ICES–003 Class B, VCCI Class B, C–tick AS/NZS CISPR 22 Class B, KCC KN22 Class B, KN24, IEC/EN/UL 60950–1, IEC/EN/UL 60950–22, IEC 60068–2–1, IEC 60068–2–2, IEC 60068–2–6, IEC 60068–2–14, IEC 60068–2–27, IEC 60068–2–30, IEC 60068–2–78, IEC 60529 IP66, EN 50581, NEMA 250 Type 4X, ISO 4892–2
	Weight	3.5 kg (7.7 lb)
	Included accessories	Installation Guide, AVHS Authentication key, installation and management software CD, Windows decoder 1–user license
Video management software (sold separately)	Video management software (sold separately)	AXIS Camera Companion (included), AXIS Camera Station and video management software from Axis' Application Development Partners (not included). For more information, see www.axis.com/products/video/software
	Optional accessories	Smoked dome cover T8123 High PoE–30W Midspan 1–port AXIS T94P01B Corner Bracket AXIS T8310 Video Surveillance Control Board AXIS T90A Illuminators Installation Display Multi–user decoder license pack

Connectors

I/O Terminal Connector

6–pin terminal block for:

- Digital Input
- Digital Output
- Auxiliary power and ground (GND)

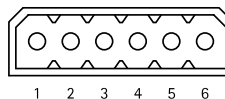

Function	Pin	Notes	Specifications
GND	1	Ground	
12 V DC Power	2	Can be used to power auxiliary equipment. Note: This pin can only be used as power out.	Max load = 50 mA

AXIS P5414-E PTZ Dome Network Camera

Technical Specifications

Configurable (Input or Output)	3-6	Digital input – Connect to GND to activate, or leave floating (unconnected) to deactivate.	0 to +30 V DC
		Digital output – Internal connection to ground when activated, floating (unconnected) when deactivated. If used with an inductive load, e.g. a relay, a diode must be connected in parallel with the load, for protection against voltage transients.	Max load = 100 mA Max voltage = +30 V DC

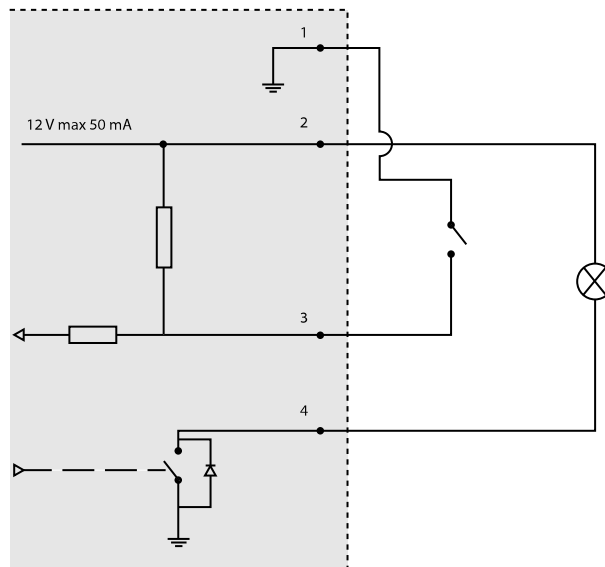

- 3. I/O configured as input
- 4. I/O configured as output

Power Connector

2-pin terminal block for power input. Use a Safety Extra Low Voltage (SELV) compliant limited power source (LPS) with either a rated output power limited to ≤ 100 W or a rated output current limited to ≤ 5 A.

DC power input

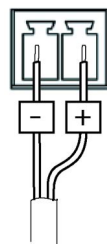

Audio Connector

4-pin terminal block for:

- Audio input
- Audio output

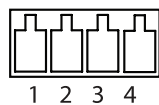

AXIS P5414–E PTZ Dome Network Camera

Technical Specifications

Function	Pin	Notes
Microphone/Line in	1	Microphone or line in (mono)
GND	2	Ground
Line out	3	Line audio out
GND	4	Ground

SD Card Slot

Supports SD cards with up to 64 GB of storage. For best recording performance, use an SDHC or SDXC card with speed class 10.

Performance Considerations

When settings up your system, it is important to consider how various settings and situations will affect performance. Some factors affect the amount of bandwidth (the bit rate) required, others can affect the frame rate, and some affect both. If the load on the CPU reaches its maximum, this will also affect the frame rate.

The following factors are among the most important to consider:

- High image resolution and/or lower compression levels result in images containing more data. Bandwidth affected.
- Access by large numbers of Motion JPEG and/or unicast H.264 clients. Bandwidth affected.
- Simultaneous viewing of different streams (resolution, compression) by different clients. Effect on frame rate and bandwidth.
- Accessing Motion JPEG and H.264 video streams simultaneously. Frame rate and bandwidth affected.
- Heavy usage of event settings affect the product's CPU load. Frame rate affected.
- Heavy network utilization due to poor infrastructure. Bandwidth affected.
- Viewing on poorly performing client computers lowers perceived performance. Frame rate affected.

User Manual
AXIS P5414-E PTZ Dome Network Camera
© Axis Communications AB, 2013

Ver. M2.2
Date: November 2013
Part No. 54724

Free Manuals Download Website

<http://myh66.com>

<http://usermanuals.us>

<http://www.somanuals.com>

<http://www.4manuals.cc>

<http://www.manual-lib.com>

<http://www.404manual.com>

<http://www.luxmanual.com>

<http://aubethermostatmanual.com>

Golf course search by state

<http://golfingnear.com>

Email search by domain

<http://emailbydomain.com>

Auto manuals search

<http://auto.somanuals.com>

TV manuals search

<http://tv.somanuals.com>