



LX60ST/LW61ST  
Digital Projector  
User Manual

# Table of contents

Important safety instructions .....	3	Adjusting the sound .....	36
Introduction .....	7	Presenting from a USB Reader.....	37
Projector features.....	7	Shutting down the projector .....	38
Shipping contents .....	8	Direct power off.....	38
Projector exterior view.....	9	Menu operation .....	39
Controls and functions .....	10	<b>Maintenance.....</b>	<b>48</b>
<b>Positioning your projector.....</b>	<b>14</b>	Care of the projector .....	48
Choosing a location.....	14	Light source information .....	49
Obtaining a preferred projected image size.....	15	<b>Troubleshooting .....</b>	<b>52</b>
<b>Connection .....</b>	<b>17</b>	<b>Specifications .....</b>	<b>53</b>
Connecting video source devices.....	18	Projector specifications.....	53
Playing sound through the projector..	18	Dimensions .....	54
<b>Operation.....</b>	<b>20</b>	Wall mount installation .....	54
Starting up the projector .....	20	Timing chart.....	57
Adjusting the projected image .....	21	<b>Warranty and Copyright information .....</b>	<b>60</b>
Using the menus.....	23		
Securing the projector .....	24		
Switching input signal .....	27		
Magnifying and searching for details ...	28		
Selecting the aspect ratio .....	28		
Optimizing the image .....	30		
Setting the presentation timer .....	33		
Remote paging operations .....	34		
Freezing the image .....	34		
Hiding the image.....	34		
Locking control keys .....	35		
Operating in a high altitude environment.....	35		
Creating your own startup screen.....	35		

# Important safety instructions

Your projector is designed and tested to meet the latest standards for safety of information technology equipment. However, to ensure safe use of this product, it is important that you follow the instructions mentioned in this manual and marked on the product.

## Safety Instructions

1. **Please read this manual before you operate your projector.** Save it for future reference.

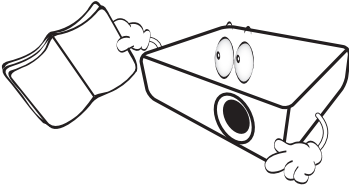

2. **Do not look straight at the projector lens during operation.** The intense light beam may damage your eyes.

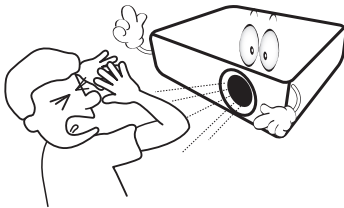

3. **Refer servicing to qualified service personnel.**

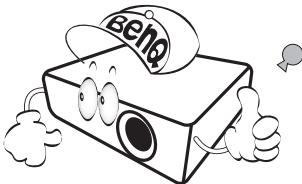

4. **Always open the lens shutter (if any) or remove the lens cap (if any) when the projector light source is on.**

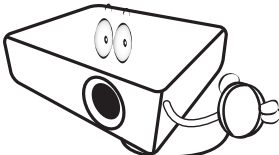

5. In some countries, the line voltage is NOT stable. This projector is designed to operate safely within a mains voltage between 100 to 240 volts AC, but could fail if power cuts or surges of  $\pm 10$  volts occur. **In areas where the mains voltage may fluctuate or cut out, it is recommended that you connect your projector through a power stabilizer, surge protector or uninterruptible power supply (UPS).**

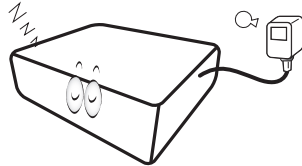

6. Do not block the projection lens with any objects when the projector is under operation as this could cause the objects to become heated and deformed or even cause a fire. To temporarily turn off the light source, press **ECO BLANK** on the projector or remote control.

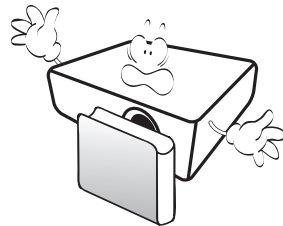

## Safety Instructions (Continued)

7. Do not operate light sources beyond the rated light source life. Excessive operation of light sources beyond the rated life could cause them to fail on rare occasions.

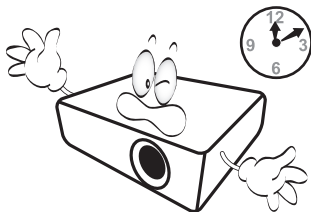

8. Do not place this product on an unstable cart, stand, or table. The product may fall, sustaining serious damage.

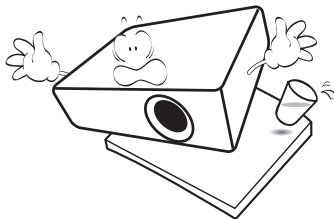

9. Do not attempt to disassemble this projector. There are dangerous high voltages inside which may cause death if you should come into contact with live parts.

Under no circumstances should you ever undo or remove any cover. Refer servicing only to suitably qualified professional service personnel.

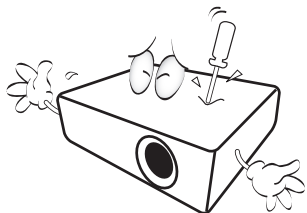

10. When the projector is under operation, you may sense some heated air and odor from its ventilation grill. It is a normal phenomenon and not a product defect.

11. Do not place this projector in any of the following environments.

- Space that is poorly ventilated or confined. Allow at least 50 cm clearance from walls and free flow of air around the projector.
- Locations where temperatures may become excessively high, such as the inside of a car with all windows rolled up.
- Locations where excessive humidity, dust, or cigarette smoke may contaminate optical components, shorten the projector's life span and darken the image.

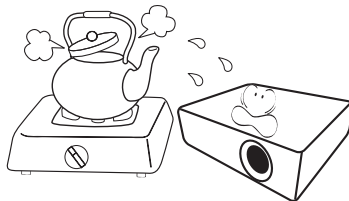

- Locations near fire alarms
- Locations with an ambient temperature above 40°C / 104°F
- Locations where the altitudes are higher than 3000 m (10000 feet).

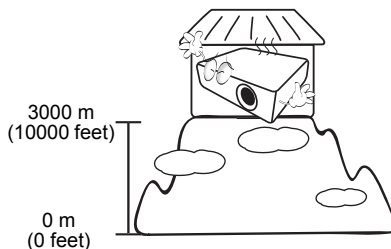

## Safety Instructions (Continued)

12. Do not block the ventilation holes.
- Do not place this projector on a blanket, bedding or any other soft surface.
  - Do not cover this projector with a cloth or any other item.
  - Do not place inflammables near the projector.

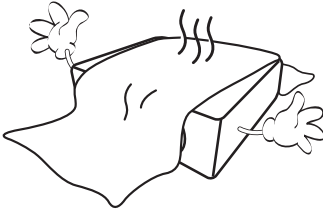

If the ventilation holes are seriously obstructed, overheating inside the projector may result in a fire.

13. Always place the projector on a level, horizontal surface during operation.
- Do not use if tilted at an angle of more than 10 degrees left to right, nor at angle of more than 15 degrees front to back. Using the projector when it is not fully horizontal may cause a malfunction of, or damage to, the light source.

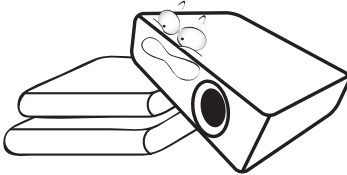

14. Do not stand the projector on end vertically. Doing so may cause the projector to fall over, causing injury or resulting in damage to the projector.

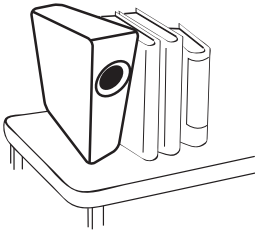

15. Do not step on the projector or place any objects upon it. Besides probable physical damage to the projector, doing so may result in accidents and possible injury.

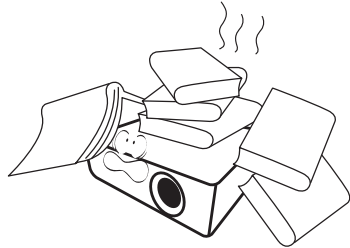

16. Do not place liquids near or on the projector. Liquids spilled into the projector may cause it to fail. If the projector does become wet, disconnect it from the power supply's power outlet and call BenQ to have the projector serviced.

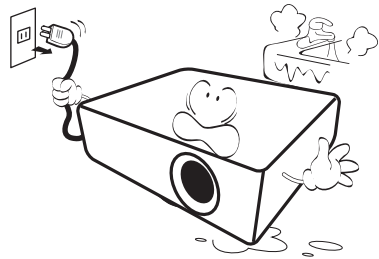

17. This product is capable of displaying inverted images for ceiling mount installation.



Use only BenQ's Ceiling Mount Kit for mounting the projector and ensure it is securely installed.

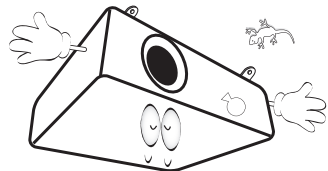

18. This apparatus must be earthed.

## Safety Instructions (Continued)



### Ceiling mounting the projector

We want you to have a pleasant experience using your BenQ projector, so we need to bring this safety matter to your attention to prevent possible damage to person and property.

If you intend to mount your projector on the ceiling, we strongly recommend that you use a proper fitting BenQ projector ceiling mount kit and that you ensure it is securely and safely installed.

If you use a non-BenQ brand projector ceiling mount kit, there is a safety risk that the projector may fall from the ceiling due to an improper attachment through the use of the wrong gauge or length screws.

You can purchase a BenQ projector ceiling mount kit from the place you purchased your BenQ projector. BenQ recommends that you also purchase a separate Kensington lock compatible security cable and attach it securely to both the Kensington lock slot on the projector and the base of the ceiling mount bracket. This will perform the secondary role of restraining the projector should its attachment to the mounting bracket become loose.

# Introduction

## Projector features

The projector integrates high-performance optical engine projection and a user-friendly design to deliver high reliability and ease of use.

The projector offers the following features.

- ECO BLANK - With technology, the Eco Blank function will save up to 90% of your light source power at the same time your image is hiding
  - Network Settings allowing management of projector status from a computer using a web browser
  - Microphone jack to output the sound through the projector speaker
  - USB MINI-B jack to display computer signal through a USB cable
  - USB TYPE-A jack to present images stored on a USB flash drive
  - 3D function to enjoy the 3D movies, videos, and sporting events in a more realistic way by presenting the depth of the images
  - Filter free design to lower maintenance and operating costs
  - Auto keystone function to correct image keystone automatically
  - Brilliant color / VID1 to provide truer, more vibrant colors in picture
  - Closed captioning to display the dialogue, narration, and sound effects of TV programs and videos
  - Variable audio output
  - Wall color correction allowing projection on surfaces of several predefined colors
  - Quick auto search speeding up the signal detecting process
  - Selectable password protected function
  - 3D color management allowing color adjustments to your liking
  - Presentation timer for better control of time during presentations
  - One-key auto-adjustment to display the best picture quality
  - Digital keystone correction to correct distorted images
  - Adjustable color balance control for data/video display
  - Ability to display 1.07 billion colors
  - Multi-language On-Screen Display (OSD) menus
  - Switchable normal and economic modes to reduce the power consumption
  - Built-in speakers providing mixed mono audio when an audio input is connected
  - Component HDTV compatibility (YPbPr)
-  • The apparent brightness of the projected image will vary depending on the ambient lighting conditions, selected input signal contrast/brightness settings, and is directly proportional to projection distance.
- The light source brightness will decline over time and may vary within the light source manufacturers specifications. This is normal and expected behavior.

# Shipping contents

Carefully unpack and verify that you have all of the items shown below. If any of these items are missing, please contact your place of purchase.

## Standard accessories

 The supplied accessories will be suitable for your region, and may differ from those illustrated.

\*The warranty card is only supplied in some specific regions. Please consult your dealer for detailed information.

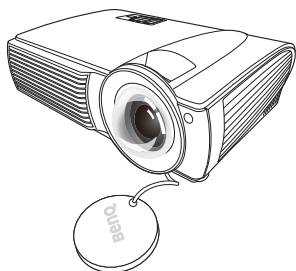

Projector

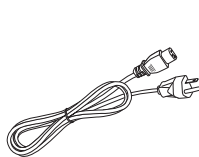

Power cord

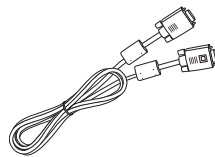

VGA cable

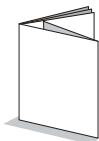

Quick start guide



User manual CD



Warranty card\*

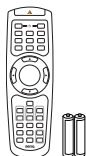

Remote control with batteries

## Optional accessories

1. Wall mount kit
2. RS232 cable
3. Soft carry bag



# Projector exterior view

## Front/upper side

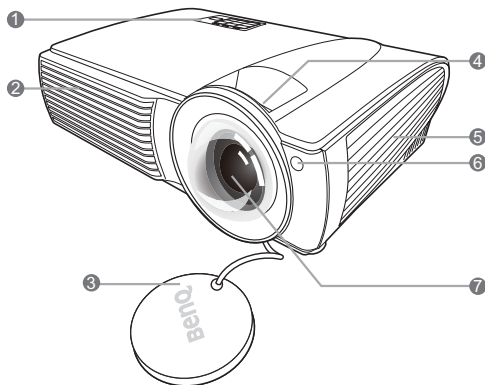

1. External control panel  
(See "[Controls and functions](#)" on page 10 for details.)
2. Vent (cool air intake)
3. Lens cover
4. Focus ring
5. Vent (heated air exhaust)
6. Front IR remote sensor
7. Projection lens
8. AC power jack
9. 12V DC output terminal  
Used to trigger external devices such as an electric screen or light control, etc. Consult your dealer for how to connect these devices.

## Rear/lower side

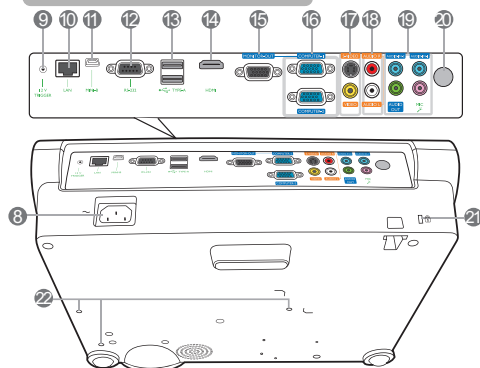

10. RJ45 LAN input jack
11. USB Mini-B port
12. RS232 control port
13. USB Type-A ports
14. HDMI-input port
15. RGB signal output jack
16. RGB (PC)/Component Video (YPbPr/YCbCr) signal input jack
17. S-Video input jack  
Video input jack
18. Audio (L/R) input jacks
19. Audio input jacks  
Audio output jack  
Microphone jack
20. Rear IR remote sensor
21. Kensington anti-theft lock slot
22. Ceiling mount holes

# Controls and functions

## Projector

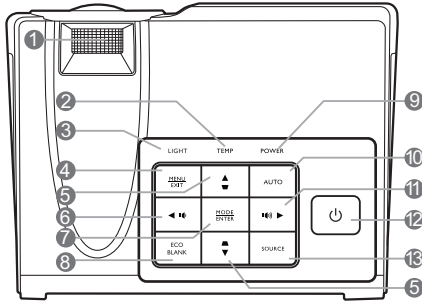

1. **Focus ring**  
Adjusts the focus of the projected image.
2. **TEMPERature warning light**  
Lights up red if the projector's temperature becomes too high.
3. **LIGHT indicator light**  
Indicates the status of the light source. Lights up or flashes when the light source has developed a problem.
4. **MENU/EXIT**  
Turns on the On-Screen Display (OSD) menu. Goes back to previous OSD menu, exits and saves menu settings.
5. **Keystone/Arrow keys** ( ▽ / ▲ Up, △ / ▼ Down)  
Manually corrects distorted images resulting from an angled projection.
6. **◀ Left/ 🔊**  
Decreases the projector volume.
7. **MODE/ENTER**  
Selects an available picture setup mode. Activates the selected On-Screen Display (OSD) menu item.
8. **ECO BLANK**  
Used to hide the screen picture.
9. **POWER indicator light**  
Lights up or flashes when the projector is under operation.
10. **AUTO**  
Automatically determines the best picture timings for the displayed image.
11. **▶ Right/ 🔊**  
Increases the projector volume. When the On-Screen Display (OSD) menu is activated, the #6, #5, and #11 keys are used as directional arrows to select the desired menu items and to make adjustments.
12. **POWER**  
Toggles the projector between standby mode and on.
13. **SOURCE**  
Displays the source selection bar.

# Remote control

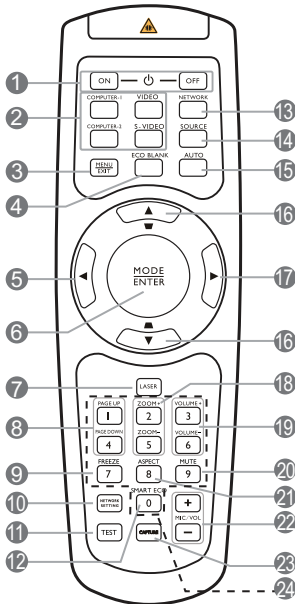

1. **ON/OFF**  
Toggles the projector between standby mode and on.
2. **Source selection buttons (COMPUTER-1, COMPUTER-2, VIDEO, S-VIDEO)**  
Selects an input source for display.
3. **MENU/EXIT**  
Turns on the On-Screen Display (OSD) menu. Goes back to previous OSD menu, exits and saves menu settings.
4. **ECO BLANK**  
Used to hide the screen image.
5. **◀ Left**  
Decreases the projected image brightness.
6. **MODE/ENTER**  
Selects an available picture setup mode.  
Activates the selected On-Screen Display (OSD) menu item.
7. **LASER**  
Emits visible laser pointer light for presentation purposes.
8. **PAGE UP/PAGE DOWN**  
Operates your display software program (on a connected PC) which responds to page up/down commands (like Microsoft PowerPoint).
9. **FREEZE**  
Freezes the projected image.
10. **NETWORK SETTING**  
Enters network setting directly.
11. **TEST**  
Displays the test pattern.
12. **SMART ECO**  
Displays the light source mode selection bar.
13. **NETWORK**  
Searches the network signal and project it within a few seconds once available.
14. **SOURCE**  
Displays the source selection bar.
15. **AUTO**  
Automatically determines the best picture timings for the displayed image.
16. **Keystone/Arrow buttons (◁ / ▲ Up, ▷ / ▼ Down)**  
Manually corrects distorted images resulting from an angled projection.
17. **▶ Right**  
Increases the projected image brightness.  
When the On-Screen Display (OSD) menu is activated, the #5, #16 and #17 buttons are used as directional arrows to select the desired menu items and to make adjustments.

## 18. ZOOM+/ZOOM-

Magnifies or reduces the projected image size.

## 19. VOLUME+/VOLUME-

Adjusts the sound level.

## 20. MUTE

Toggles projector audio between on and off.

## 21. ASPECT

Selects the display aspect ratio.

## 22. MIC/VOL +/-

Adjusts the microphone sound level.

## 23. CAPTURE

Captures the projected picture and save it as your startup screen.

## 24. Numeric buttons

Enters numbers in network settings.



Numeric buttons 1, 2, 3, 4 cannot be pressed when asked to enter password.

## Operating the LASER pointer

The Laser Pointer is a presentation aid for professionals. It emits red colored light when you press it.

The laser beam is visible. It is necessary to press and hold **LASER** for continuous output.

Avoid Exposure  
Laser radiation is emitted from this aperture



Do not look into the laser light window or shine the laser light beam on yourself or others. See the warning messages on the back of the remote control prior to using it.

The laser pointer is not a toy. Parents should be mindful of the dangers of laser energy and keep this remote control out of the reach of children.

## Remote control effective range

Infra-Red (IR) remote control sensors are located on the front and the rear of the projector. The remote control must be held at an angle within 30 degrees perpendicular to the projector's IR remote control sensors to function correctly. The distance between the remote control and the sensors should not exceed 8 meters (~ 26 feet).

Make sure that there are no obstacles between the remote control and the IR sensors on the projector that might obstruct the infra-red beam.

- **Operating the projector from the front**
- **Operating the projector from the rear**

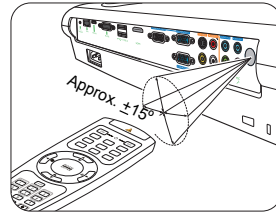
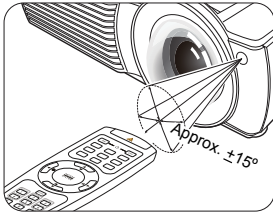

## Replacing the remote control batteries

1. To open the battery cover, turn the remote control over to view its back, push on the finger grip on the cover and slide it up in the direction of the arrow as illustrated. The cover will slide off.
2. Remove any existing batteries (if necessary) and install two AAA batteries observing the battery polarities as indicated in the base of the battery compartment. Positive (+) goes to positive and negative (-) goes to negative.
3. Refit the cover by aligning it with the base and sliding it back down into position. Stop when it clicks into place.

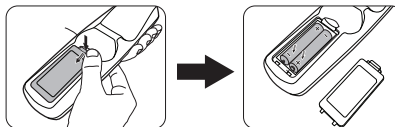

- ⚠ Avoid leaving the remote control and batteries in an excessive heat or humid environment like the kitchen, bathroom, sauna, sunroom or in a closed car.
- Replace only with the same or equivalent type recommended by the battery manufacturer.
- Dispose of the used batteries according to the manufacturer's instructions and local environment regulations for your region.
- Never throw the batteries into a fire. There may be danger of an explosion.
- If the batteries are dead or if you will not be using the remote control for an extended period of time, remove the batteries to avoid damage to the remote control from possible battery leakage.

# Positioning your projector

## Choosing a location

Your projector is designed to be installed in one of four possible installation locations:

### 1. Front Table

Select this location with the projector placed on the table in front of the screen. This is the most common way to position the projector for quick setup and portability.

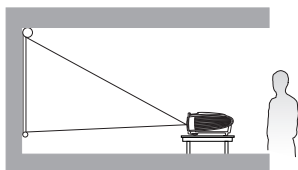

### 2. Front Ceiling

Select this location with the projector suspended upside-down from the ceiling in front of the screen.

Purchase the BenQ Projector Ceiling Mount Kit from your dealer to mount your projector on the ceiling.

Set **Front Ceiling** in the **SYSTEM SETUP: Basic > Projector Position** menu after you turn the projector on.

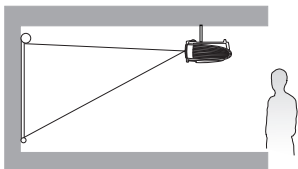

### 3. Rear Ceiling

Select this location with the projector suspended upside-down from the ceiling behind the screen.

Note that a special rear projection screen and the BenQ Projector Ceiling Mount Kit are required for this installation location.

Set **Rear Ceiling** in the **SYSTEM SETUP: Basic > Projector Position** menu after you turn the projector on.

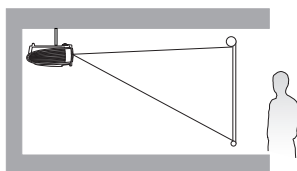

### 4. Rear Table

Select this location with the projector placed on the table behind the screen.

Note that a special rear projection screen is required.

Set **Rear Table** in the **SYSTEM SETUP: Basic > Projector Position** menu after you turn the projector on.

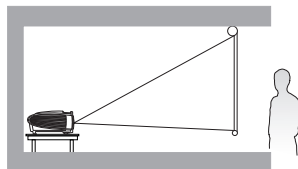

Your room layout or personal preference will dictate which installation location you select. Take into consideration the size and position of your screen, the location of a suitable power outlet, as well as the location and distance between the projector and the rest of your equipment.

# Obtaining a preferred projected image size

The distance from the projector lens to the screen, the zoom setting, and the video format each factors in the projected image size.

## Projection dimensions

Refer to ["Dimensions" on page 54](#) for the center of lens dimensions of this projector before calculating the appropriate position.

### LX60ST

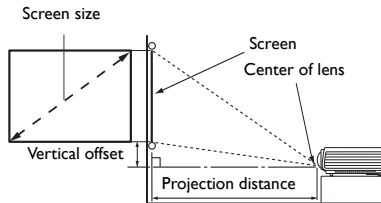

Screen size				Distance from screen (mm)	Vertical offset (mm)
Diagonal		W (mm)	H (mm)		
Inch	mm				
80	2032	1626	1219	988	183
100	2540	2032	1524	1235	229
120	3048	2438	1829	1481	274
150	3810	3048	2286	1852	343
180	4572	3658	2743	2222	411
200	5080	4064	3048	2469	457
220	5588	4470	3353	2716	503
240	6096	4877	3658	2963	549
270	6858	5486	4115	3333	617
300	7620	6096	4572	3704	686

For example, if you are using a 120-inch screen, the recommended projection distance is 1481 mm and the vertical offset is 274 mm.

If your measured projection distance is 2.0 m (2000 mm), the closest match in the ["Distance from screen \(mm\)"](#) column is 1852 mm. Looking across this row shows that a 150" (about 3.8 m) screen is required.

# LW61ST

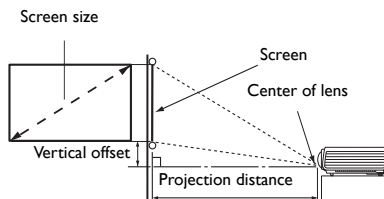

Screen size				Distance from screen (mm)	Vertical offset (mm)
Diagonal		W (mm)	H (mm)		
Inch	mm				
80	2032	1723	1077	842	53.85
100	2540	2154	1346	1053	67
120	3048	2585	1615	1263	81
150	3810	3231	2019	1579	101
180	4572	3877	2423	1895	121
200	5080	4308	2692	2105	135
220	5588	4739	2962	2316	148
240	6096	5169	3231	2526	162
270	6858	5816	3635	2842	182
300	7620	6462	4039	3158	202

For example, if you are using a 120-inch screen, the recommended projection distance is 1263 mm and the vertical offset is 81 mm.

If your measured projection distance is 1.5 m (1500 mm), the closest match in the "Distance from screen (mm)" column is 1579 mm. Looking across this row shows that a 150" (about 3.8 m) screen is required.

 All measurements are approximate and may vary from the actual sizes.

BenQ recommends that if you intend to permanently install the projector, you should physically test the projection size and distance using the actual projector in situ before you permanently install it, so as to make allowance for this projector's optical characteristics. This will help you determine the exact mounting position so that it best suits your installation location.



# Connection

When connecting a signal source to the projector, be sure to:

1. Turn all equipment off before making any connections.
2. Use the correct signal cables for each source.
3. Ensure the cables are firmly inserted.

- ☞ In the connections shown below, some cables may not be included with the projector (see "[Shipping contents](#)" on page 8). They are commercially available from electronics stores.
- The connection illustrations below are for reference only. The rear connecting jacks available on the projector vary with each projector model.

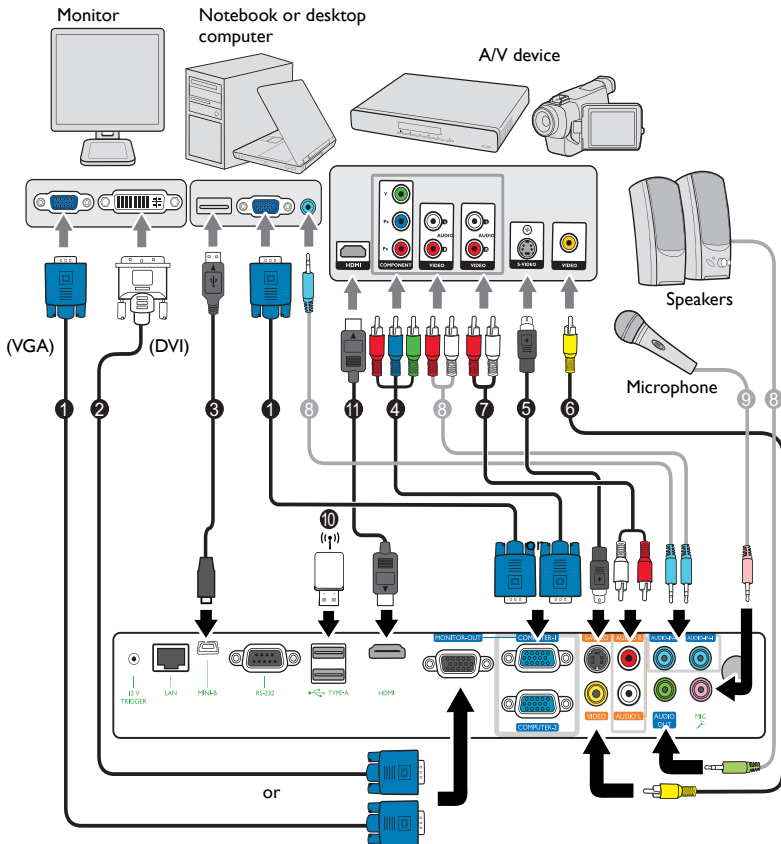









- |  |  |
|--|--|
| <ol style="list-style-type: none"> <li>1. VGA cable</li> <li>2. VGA to DVI-A cable</li> <li>3. USB cable</li> <li>4. Component Video to VGA (D-Sub) adapter cable</li> <li>5. S-Video cable</li> </ol> | <ol style="list-style-type: none"> <li>6. Video cable</li> <li>7. Audio L/R cable</li> <li>8. Audio cable</li> <li>9. Microphone</li> <li>10. USB flash drive/USB wireless dongle</li> <li>11. HDMI cable</li> </ol> |
|--|--|

-  Many notebooks do not turn on their external video ports when connected to a projector. Usually a key combo like FN + F3 or CRT/LCD key turns the external display on/off. Locate a function key labeled CRT/LCD or a function key with a monitor symbol on the notebook. Press FN and the labeled function key simultaneously. Refer to your notebook's documentation to find your notebook's key combination.
- The D-Sub output only works when an appropriate D-Sub input is made to the **COMPUTER I** jack.
- If you wish to use this connection method when the projector is in standby mode, make sure the **Monitor Out** function is turned on in the **SYSTEM SETUP: Advanced** menu. See "[Standby Settings](#)" on [page 46](#) for details.

## Connecting video source devices

You need only connect the projector to a video source device using just one of the connecting methods, however each provides a different level of video quality. The method you choose will most likely depend upon the availability of matching terminals on both the projector and the video source device as described below:

Terminal name	Terminal appearance	Picture quality
<b>HDMI</b>		 Best
<b>Component Video</b>		 Better
<b>S-Video</b>		 Good
<b>Video</b>		 Normal

### Connecting audio

The projector has two built-in mono speakers which are designed to provide basic audio functionality accompanying data presentations for business purposes only. They are not designed for, nor intended for stereo audio reproduction use as might be expected in home theater or home cinema applications. Any stereo audio input (if provided), is mixed into a common mono audio output through the projector speakers.

The built-in speakers will be muted when the **AUDIO OUT** jack is connected.

-  In the unlikely event that you connect the projector to a DVD player via the projector's **HDMI** input and the projected picture displays wrong colors, please change the color space to **YUV**. See "[Changing Color Space](#)" on [page 27](#) for details.
- The projector is only capable of playing mixed mono audio, even if a stereo audio input is connected. See "[Connecting audio](#)" on [page 18](#) for details.
- If the selected video image is not displayed after the projector is turned on and the correct video source has been selected, check that the video source device is turned on and operating correctly. Also check that the signal cables have been connected correctly.

## Playing sound through the projector

You can make use of the projector (mixed mono) speaker in your presentations, and also connect separate amplified speakers to the **AUDIO OUT** socket of the projector.

If you have a separate sound system, you will most likely want to connect the audio output of your Video source device to that sound system, instead of to the mono audio projector.

You can also use a microphone to output the sound through the projector speaker.

Once connected, the audio can be controlled by the projector On-Screen Display (OSD) menus. See "[Audio Settings](#)" on [page 45](#) for details.

The table below describes the connection methods for different devices, and where the sound is from.

Device	PC/Component Video	Video/S-Video	Microphone
Audio input port	AUDIO IN 1/AUDIO IN 2	AUDIO (L/R)	MIC 
The projector can play the sound from...	AUDIO IN 1/AUDIO IN 2/MIC	AUDIO (L/R)/MIC	<ul style="list-style-type: none"> <li>• MIC</li> <li>• AUDIO IN 1/MIC</li> <li>• AUDIO IN 2 (L/R)/MIC</li> </ul>
Audio output port	AUDIO OUT	AUDIO OUT	AUDIO OUT
The selected input signal determines which sound will be played by the projector speaker, and which sound will be output from the projector when <b>AUDIO OUT</b> is connected. If you select the <b>COMPUTER 1/YPbPr 1</b> signal, the projector can play the sound received from <b>AUDIO IN 1/MIC</b> . If you select the <b>COMPUTER 2/YPbPr 2</b> signal, the projector can play the sound received from <b>AUDIO IN 2/MIC</b> .			

 The projector can play sound if the connected RJ45 cable or USB cable carries audio signal. There is no need to connect the audio cable when the **USB Display** or **Network Display** source is selected.

### About the microphone input

- If you wish to use a microphone, connect a 3.5 mini jack cable microphone to the projector.
- You can use a wireless microphone as long as a wireless module is attached to the projector's microphone input jack and it works well with the associated devices. To ensure a quality use of the wireless microphone, it is recommended that your microphone conforms to the specifications listed in the table below.

Signal	Parameter	Min	Type	Max	
Microphone	Transducer Principle				Dynamic
	Impedance	300		1K	ohm
	Frequency response	600		16k	Hz

- There are two ways to adjust microphone volumes.
  - Directly set microphone volume levels in the **SYSTEM SETUP: Advanced > Audio Settings > Microphone Volume** menu.
  - Press **MIC/VOL** keys (+/-) on the remote control.
- To make the microphone input available when the projector is in standby mode, turn on the **SYSTEM SETUP: Advanced > Standby Settings > Microphone** menu.
- If the microphone is not working, check the volume setting and cable connection.
- You might get feedback noise from the microphone when you are too close to the speaker of the projector. Move the microphone away from the speaker of the projector. The greater volume you require, the greater distance you need to be away from the speaker to prevent the noise.

# Operation

## Starting up the projector

1. Plug the power cord into the projector and into a power outlet. Turn on the power outlet switch (where fitted). Check that the **POWER indicator light** on the projector lights orange after power has been applied.

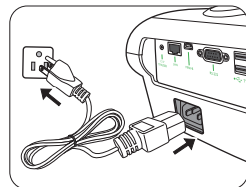

⚠ Please use the original accessories (e.g. power cord) only with the device to avoid possible dangers such as electric shock and fire.

2. Press **POWER** or **ON** to start the projector. As soon as the light source lights up, a "Power On Tone" will be heard. The **POWER indicator light** flashes green and stays green when the projector is on.

(If necessary) Rotate the focus ring to adjust the image clearness.

To turn off the ring tone, see "[Turning off the Power On/Off Ring Tone](#)" on page 36 for details.

3. If the projector is activated for the first time, select your OSD language following the on-screen instructions.
4. If you are prompted for a password, press the arrow keys to enter a six-digit password. See "[Utilizing the password function](#)" on page 24 for details.
5. Switch all of the connected equipment on.
6. The projector will start to search for input signals. The current input signal being scanned displays in the upper left corner of the screen. If

Please select language			
English	한국어	Hrvatski	हिंदी
Français	Svenska	Română	
Deutsch	Nederlands	Norsk	
Italiano	Türkçe	Dansk	
Español	Čeština	Български	
Русский	Português	suomi	
繁體中文	ไทย	Indonesian	
简体中文	Polski	Ελληνικά	
日本語	Magyar	العربية	
Press Enter to Confirm, Exit to leave			

the projector doesn't detect a valid signal, the message "No Signal" will continue displaying until an input signal is found.

You can also press **SOURCE** on the projector or remote control to select your desired input signal. See "[Switching input signal](#)" on page 27 for details.

☞ If the frequency/resolution of the input signal exceeds the projector's operating range, you will see the message "Out of Range" displayed on a blank screen. Please change to an input signal which is compatible with the projector's resolution or set the input signal to a lower setting. See "[Timing chart](#)" on page 57 for details.

# Adjusting the projected image

## Adjusting the projection angle

The projector is equipped 2 adjuster feet. These adjusters change the image height and projection angle. To adjust the projector:

Screw the adjuster feet to fine-tune the horizontal angle.

To retract the feet, screw the adjuster feet in a reverse direction.

If the projector is not placed on a flat surface or the screen and the projector are not perpendicular to each other, the projected image becomes trapezoidal. To correct this situation, see "[Correcting keystone](#)" on page 22 for details.

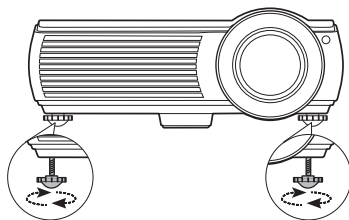

Do not look into the lens while the light source is on. The strong light from the light source may cause damage to your eyes.

Be careful when you press the quick-release button as it is close to the exhaust vent where hot air comes from.

## Auto-adjusting the image

In some cases, you may need to optimize the picture quality. To do this, press **AUTO** on the projector or remote control. Within 3 seconds, the built-in Intelligent Auto Adjustment function will re-adjust the values of Frequency and Clock to provide the best picture quality.

The current source information will be displayed in the corner of the screen for 3 seconds.

 This function is only available when PC signal (analog RGB) is selected.

## Fine-tuning the image clarity

Sharpen the image by rotating the focus ring.

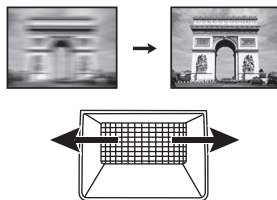

## Correcting keystone

Keystoning refers to the situation where the projected image is noticeably wider at either the top or bottom. It occurs when the projector is not perpendicular to the screen.

To correct this, besides adjusting the height of the projector, if you want the projector to automatically correct image keystoning, be sure the **Auto Keystone** function in the **DISPLAY** menu is **On**.

Or you will need to manually correct it following **ONE** of these steps.

- Using the remote control

Press  $\triangle$  /  $\nabla$  on the projector or remote control to display the Keystone correction page. Press  $\triangle$  to correct keystoning at the top of the image. Press  $\nabla$  to correct keystoning at the bottom of the image.



- Using the OSD menu

1. Press **MENU/EXIT** and then press  $\blacktriangleleft$  /  $\blacktriangleright$  until the **DISPLAY** menu is highlighted.
2. Press  $\blacktriangledown$  to highlight **Keystone** and press **MODE/ENTER**. The **Keystone** correction page is displayed.
3. Press  $\triangle$  to correct keystoning at the top of the image. Press  $\nabla$  to correct keystoning at the bottom of the image.

# Using the menus

The projector is equipped with On-Screen Display (OSD) menus for making various adjustments and settings.

Below is the overview of the OSD menu.

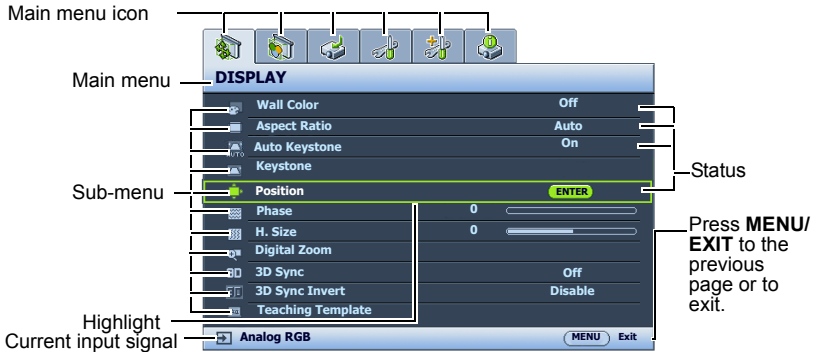

The following example describes how to set the OSD language.

1. Press **MENU/EXIT** on the projector or remote control to turn the OSD menu on.
3. Press **▼** to highlight **Language** and press **◀/▶** to select a preferred language.



2. Use **◀/▶** to highlight the **SYSTEM SETUP: Basic** menu.
4. Press **MENU/EXIT** twice\* on the projector or remote control to leave and save the settings.



\*The first press leads you back to the main menu and the second press closes the OSD menu.

# Securing the projector

## Using a security cable lock

The projector has to be installed in a safe place to prevent theft. Otherwise, purchase a lock, such as the Kensington lock, to secure the projector. You can locate a Kensington lock slot on the projector.

A Kensington security cable lock is usually a combination of key(s) and the lock. Refer to the lock's documentation for finding out how to use it.

## Utilizing the password function

For security purposes and to help prevent unauthorized use, the projector includes an option for setting up password security. The password can be set through the On-Screen Display (OSD) menu.

 **WARNING:** You will be inconvenienced if you activate the password functionality and subsequently forget the password. Print out this manual (if necessary) and write the password you used in this manual, and keep the manual in a safe place for later recall.

### Setting a password

 Once a password has been set and the power on lock is activated, the projector cannot be used unless the correct password is entered every time the projector is started.

1. Open the OSD menu and go to the **SYSTEM SETUP: Advanced > Security Settings** menu. Press **MODE/ENTER**. The **Security Settings** page is displayed.
2. Highlight **Change Security Settings** and press **MODE/ENTER**.
3. As pictured to the right, the four arrow keys (**▲**, **▶**, **▼**, **◀**) respectively represent 4 digits (1, 2, 3, 4). According to the password you desire to set, press the arrow keys to enter six digits for the password.
4. Confirm the new password by re-entering the new password.

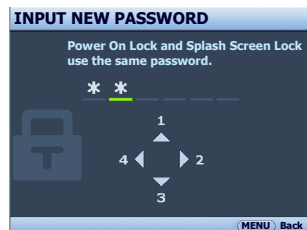

- Once the password is set, the OSD menu returns to the **Security Settings** page.
5. To activate the **Power On Lock** function, press **▲/▼** to highlight **Power On Lock** and press **◀/▶** to select **On**.
  6. To activate the **Splash Screen Lock** function, press **▲/▼** to highlight **Splash Screen Lock** and press **◀/▶** to select **On**.

When the **Splash Screen Lock** is activated, the **MyScreen** function in the **SYSTEM SETUP: Basic** menu will be password-protected.

 **IMPORTANT:** The digits being input will be displayed as asterisks on-screen. Write your selected password down here in this manual in advance or right after the password is entered so that it is available to you should you ever forget it.

Password: \_\_\_\_\_

Keep this manual in a safe place.

7. To leave the OSD menu, press **MENU/EXIT**.



## If you forget the password

If the password function is activated, you will be asked to enter the six-digit password every time you turn on the projector. If you enter the wrong password, the password error message as pictured to the right is displayed lasting for 3 seconds, and the **INPUT PASSWORD** message follows. You can retry by entering another six-digit password, or if you did not record the password in this manual, and you absolutely do not remember it, you can use the password recall procedure. See ["Entering the password recall procedure"](#) on page 25 for details.

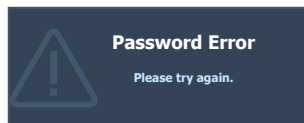

If you enter an incorrect password 5 times in succession, the projector will automatically shut down in a short time.

## Entering the password recall procedure

1. Press and hold **AUTO** on the projector or remote control for 3 seconds. The projector will display a coded number on the screen.
2. Write down the number and turn off your projector.
3. Seek help from the local BenQ service center to decode the number. You may be required to provide proof of purchase documentation to verify that you are an authorized user of the projector.

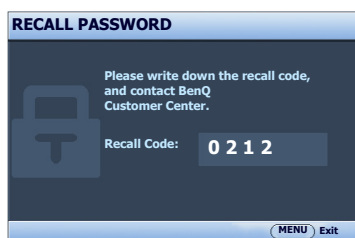

## Changing the password

1. Open the OSD menu and go to the **SYSTEM SETUP: Advanced > Security Settings > Change Password** menu.
2. Press **MODE/ENTER**. The message **"INPUT CURRENT PASSWORD"** appears.
3. Enter the old password.
  - i. If the password is correct, another message **"INPUT NEW PASSWORD"** is displayed.
  - ii. If the password is incorrect, the password error message is displayed lasting for three seconds, and the message **"INPUT CURRENT PASSWORD"** is displayed for your retry. You can press **MENU/EXIT** to cancel the change or try another password.
4. Enter a new password.

 **IMPORTANT:** The digits being input will be displayed as asterisks on-screen. Write your selected password down here in this manual in advance or right after the password is entered so that it is available to you should you ever forget it.

Password: \_\_\_\_\_

Keep this manual in a safe place.

5. Confirm the new password by re-entering the new password.
6. You have successfully assigned a new password to the projector. Remember to enter the new password next time the projector is started.
7. To leave the OSD menu, press **MENU/EXIT**.

## Disabling the password function

To disable password protection, go back to the **SYSTEM SETUP: Advanced > Security Settings > Change Security Settings** menu after opening the OSD menu system. Press **MODE/ENTER**. The message “**INPUT PASSWORD**” is displayed. Enter the current password.

- i. If the password is correct, the OSD menu returns to the **Security Settings** page.

Press **▼** to highlight **Power On Lock** and press **◀/▶** to select **Off**. You will not have to enter the password next time when turning on the projector.

Press **▼** to highlight **Splash Screen Lock** and press **◀/▶** to select **Off**. The **Splash Screen** function in the **SYSTEM SETUP: Basic** menu will be available for your change.

- ii. If the password is incorrect, the password error message is displayed lasting for three seconds, and the message “**INPUT PASSWORD**” is displayed for your retry. You can press **MENU/EXIT** to cancel the change or try another password.

 Though the password function is disabled, you need to keep the old password in hand should you ever need to re-activate the password function by entering the old password.

# Switching input signal

The projector can be connected to multiple devices at the same time. However, it can only display one full screen at a time. When starting up, the projector automatically searches for the available signals.

Be sure the **Quick Auto Search** function in the **SOURCE** menu is **On** if you want the projector to automatically search for the signals.

To select the source:

1. Press **SOURCE** on the projector or remote control. A source selection bar is displayed.
2. Press **▲/▼** until your desired signal is selected and press **MODE/ENTER**.

If available, you can also select the source by pressing one of the Source buttons on the remote control.

Once detected, the selected source information will be displayed at the corner of the screen for seconds. If there is multiple equipment connected to the projector, repeat steps 1-2 to search for another signal.

- The brightness level of the projected image will change accordingly when you switch between different input signals. Data (graphic) "PC" presentations using mostly static images are generally brighter than "Video" using mostly moving images (movies).
- For best display picture results, you should select and use an input signal which outputs at the projector's native resolution. Any other resolutions will be scaled by the projector depending upon the "aspect ratio" setting, which may cause some image distortion or loss of picture clarity. See "[Selecting the aspect ratio](#)" on page 28 for details.
- Firewall in the PC must be switched off to allow QPresenter and USB Display to work.



## Changing Color Space

In the unlikely event that you connect the projector to a DVD player via the projector's **HDMI** input and the projected picture displays wrong colors, please change the color space to **YUV**.

To do this:

1. Press **MENU/EXIT** and then press **◀/▶** until the **SOURCE** menu is highlighted.
2. Press **▼** to highlight **Color Space Conversion** and press **◀/▶** to select a suitable color space.

- This function is only available when the HDMI-input port is in use.

# Magnifying and searching for details

If you need to find the details on the projected picture, magnify the picture. Use the direction arrow keys for navigating the picture.

- Using the remote control
  1. Press **ZOOM+ZOOM-** to display the Zoom bar. Press **ZOOM+** to magnify the center of the picture. Press the key repeatedly until the picture size is suitable for your need.
  2. Use the directional arrows (**▲**, **▼**, **◀**, **▶**) on the projector or remote control to navigate the picture.
  3. To restore the picture to its original size, press **AUTO**. You can also press **ZOOM-**. When the key is pressed again, the picture is further reduced until it is restored to the original size.
- Using the OSD menu
  1. Press **MENU/EXIT** and then press **◀ / ▶** until the **DISPLAY** menu is highlighted.
  2. Press **▼** to highlight **Digital Zoom** and press **MODE/ENTER**. The Zoom bar is displayed.
  3. Press **▲** repeatedly to magnify the picture to a desired size.
  4. To navigate the picture, press **MODE/ENTER** to switch to the panning mode and press the directional arrows (**▲**, **▼**, **◀**, **▶**) on the projector or remote control to navigate the picture.
  5. To reduce size of the picture, press **MODE/ENTER** to switch back to the zoom in/out function, and press **AUTO** to restore the picture to its original size. You can also press **▼** repeatedly until it is restored to the original size.



The picture can only be navigated after it is magnified. You can further magnify the picture while searching for details.

## Selecting the aspect ratio

The “aspect ratio” is the ratio of the image width to the image height. Most analog TV and some computers are in 4:3 ratio, and digital TV and DVDs are usually in 16:9 ratio.

With the advent of digital signal processing, digital display devices like this projector can dynamically stretch and scale the image output to a different aspect than that of the image input signal.

To change the projected picture ratio (no matter what aspect the source is):

- Using the remote control
  1. Press **ASPECT** to show the current setting.
  2. Press **ASPECT** repeatedly to select an aspect ratio to suit the format of the video signal and your display requirements.
- Using the OSD menu
  1. Press **MENU/EXIT** and then press **◀ / ▶** until the **DISPLAY** menu is highlighted.
  2. Press **▼** to highlight **Aspect Ratio**.
  3. Press **◀ / ▶** to select an aspect ratio to suit the format of the video signal and your display requirements.

## About the aspect ratio

- In the pictures below, the black portions are inactive areas and the white portions are active areas.
- OSD menus can be displayed on those unused black areas.

1. **Auto:** Scales an image proportionally to fit the projector's native resolution in its horizontal or vertical width. This is suitable for the incoming image which is neither in 4:3 nor 16:9 and you want to make most use of the screen without altering the image's aspect ratio.

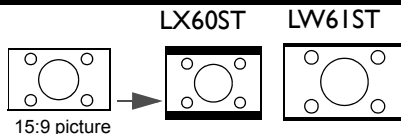

2. **Real:** The image is projected as its original resolution, and resized to fit within the display area. For input signals with lower resolutions, the projected image will display smaller than if resized to full screen. You could adjust the zoom setting or move the projector towards the screen to increase the image size if necessary. You may also need to refocus the projector after making these adjustments.

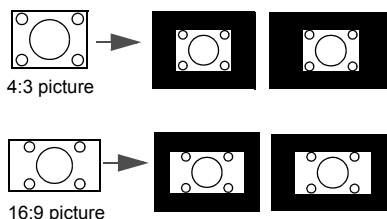

3. **4:3:** Scales an image so that it is displayed in the center of the screen with a 4:3 aspect ratio. This is most suitable for 4:3 images like some computer monitors, standard definition TV and 4:3 aspect DVD movies, as it displays them without aspect alteration.

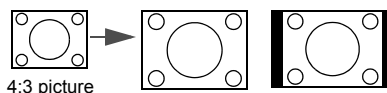

4. **16:9:** Scales an image so that it is displayed in the center of the screen with a 16:9 aspect ratio. This is most suitable for images which are already in a 16:9 aspect, like high definition TV, as it displays them without aspect alteration.

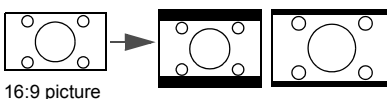

5. **16:10:** Scales an image so that it is displayed in the center of the screen with a 16:10 aspect ratio. This is most suitable for images which are already in a 16:10 aspect, as it displays them without aspect alteration.

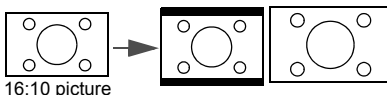

# Optimizing the image

## Using Wall Color

In the situation where you are projecting onto a colored surface such as a painted wall which may not be white, the Wall Color feature can help correct the projected picture's colors to prevent possible color difference between the source and projected pictures.

To use this function, go to the **DISPLAY > Wall Color** menu and press **◀/▶** to select a color which is closest to the color of the projection surface. There are several precalibrated colors to choose from: **Light Yellow, Pink, Light Green, Blue,** and **Blackboard**.

## Selecting a picture mode

The projector is preset with several predefined picture modes so that you can choose one to suit your operating environment and input signal picture type.

To select an operation mode that suits your need, you can follow one of the following steps.

- Press **MODE/ENTER** on the projector or remote control repeatedly until your desired mode is selected.
- Go to the **PICTURE > Picture Mode** menu and press **◀/▶** to select a desired mode.
  1. **Dynamic mode:** Maximizes the brightness of the projected image. This mode is suitable for environments where extra-high brightness is required, such as using the projector in well lit rooms.
  2. **Presentation mode:** Is designed for presentations. The brightness is emphasized in this mode to match PC and notebook coloring.
  3. **sRGB mode:** Maximizes the purity of RGB colors to provide true-to-life images regardless of brightness setting. It is most suitable for viewing photos taken with an sRGB compatible and properly calibrated camera, and for viewing PC graphic and drawing applications such as AutoCAD.
  4. **Cinema mode:** Is appropriate for playing colorful movies, video clips from digital cameras or DVs through the PC input for best viewing in a blackened (little light) environment.
  5. **User 1/User 2 mode:** Recalls the settings customized based on the current available picture modes. See "[Setting the User 1/User 2 mode](#)" on page 30 for details.

### Setting the User 1/User 2 mode

There are two user-definable modes if the current available picture modes are not suitable for your need. You can use one of the picture modes (except the **User 1/2**) as a starting point and customize the settings.

1. Press **MENU/EXIT** to open the On-Screen Display (OSD) menu.
2. Go to the **PICTURE > Picture Mode** menu.
3. Press **◀/▶** to select **User 1** or **User 2**.
4. Press **▼** to highlight **Reference Mode**.



This function is only available when **User 1** or **User 2** mode is selected up in the **Picture Mode** sub-menu item.

5. Press **◀/▶** to select a picture mode that is closest to your need.

6. Press ▼ to select a menu item to be changed and adjust the value with ◀/▶ . See "Fine-tuning the image quality in user modes" below for details.
7. When all settings have been done, highlight **Save Settings** and press **MODE/ENTER** to store the settings.
8. The confirmation message "**Setting Saved**" is displayed.

## Fine-tuning the image quality in user modes

According to the detected signal type, there are some user-definable functions available when **User 1** or **User 2** is selected. Based on your needs, you can make adjustments to these functions by highlighting them and pressing ◀/▶ on the projector or remote control.

### Adjusting **Brightness**

The higher the value, the brighter the image. And the lower the setting, the darker the image. Adjust this control so the black areas of the image appear just as black and that detail in the dark areas is visible.



### Adjusting **Contrast**

The higher the value, the greater the contrast. Use this to set the peak white level after you have previously adjusted the Brightness setting to suit your selected input and viewing environment.



### Adjusting **Color**

Lower setting produces less saturated colors. If the setting is too high, colors on the image will be overpowering, which makes the image unrealistic.

### Adjusting **Tint**

The higher the value, the more reddish the picture becomes. The lower the value, the more greenish the picture becomes.

### Adjusting **Sharpness**

The higher the value, the sharper the picture becomes. The lower the value, the softer the picture becomes.

### Adjusting **Brilliant Color**

This feature utilizes a new color-processing algorithm and system level enhancements to enable higher brightness while providing truer, more vibrant colors in picture. It enables a greater than 50% brightness increase in mid-tone images, which are common in video and natural scenes, so the projector reproduces images in realistic and true colors. If you prefer images with that quality, select **On**. If you don't need it, select **Off**.

When **Off** is selected, the **Color Temperature** function is not available.

### Selecting a color temperature

The options available for color temperature\* settings vary according to the signal type selected.

1. **Cool:** Makes images appear bluish white.
2. **Normal:** Maintains normal colorings for white.
3. **Warm:** Makes images appear reddish white.

\***About color temperatures:**

There are many different shades that are considered to be "white" for various purposes. One of the common methods of representing white color is known as the "color temperature". A white color with a low color temperature appears to be reddish white. A white color with a high color temperature appears to have more blue in it.

### 3D Color Management

In most installation situations, color management will not be necessary, such as in classroom, meeting room, or lounge room situations where lights remain on, or where building external windows allow daylight into the room.

Only in permanent installations with controlled lighting levels such as boardrooms, lecture theaters, or home theaters, should color management be considered. Color management provides fine color control adjustment to allow for more accurate color reproduction, should you require it.

Proper color management can only be achieved under controlled and reproducible viewing conditions. You will need to use a colorimeter (color light meter), and provide a set of suitable source images to measure color reproduction. These tools are not provided with the projector, however, your projector supplier should be able to provide you with suitable guidance, or even an experienced professional installer.

The Color Management provides six sets (RGBCMY) of colors to be adjusted. When you select each color, you can independently adjust its range and saturation according to your preference.

If you have purchased a test disc which contains various color test patterns and can be used to test the color presentation on monitors, TVs, projectors, etc, you can project any image from the disc on the screen and enter the **3D Color Management** menu to make adjustments.

To adjust the settings:

1. Go to the **PICTURE** menu and highlight **3D Color Management**.
2. Press **MODE/ENTER** on the projector or remote control and the **3D Color Management** page is displayed.
3. Highlight **Primary Color** and press ◀/▶ to select a color from among Red, Yellow, Green, Cyan, Blue, or Magenta.
4. Press ▼ to highlight **Hue** and press ◀/▶ to select its range. Increase in the range will include colors consisted of more proportions of its two adjacent colors.

Please refer to the illustration to the right for how the colors relate to each other.

For example, if you select Red and set its range at 0, only pure red in the projected picture will be selected. Increasing its range will include red close to yellow and red close to magenta.

5. Press ▼ to highlight **Saturation** and adjust its values to your preference by pressing ◀/▶. Every adjustment made will reflect to the image immediately.

For example, if you select Red and set its value at 0, only the saturation of pure red will be affected.

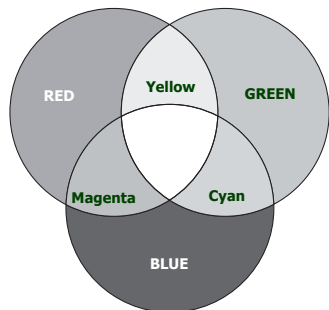



 **Saturation** is the amount of that color in a video picture. Lower settings produce less saturated colors; a setting of “0” removes that color from the image entirely. If the saturation is too high, that color will be overpowering and unrealistic.

6. Press **▼** to highlight **Gain** and adjust its values to your preference by pressing **◀/▶**. The contrast level of the primary color you select will be affected. Every adjustment made will reflect to the image immediately.
7. Repeat steps 3 to 6 for other color adjustments.
8. Make sure you have made all of the desired adjustments.
9. Press **MENU/EXIT** to exit and save the settings.

## Setting the presentation timer

Presentation timer can indicate the presentation time on the screen to help you achieve better time management when giving presentations. Follow these steps to utilize this function:

1. Go to the **SYSTEM SETUP: Basic > Presentation Timer** menu and press **MODE/ENTER** to display the **Presentation Timer** page.
2. Highlight **Timer Period** and decide the time period by pressing **◀/▶**. The length of time can be set from 1 to 5 minutes in 1-minute increments and 5 to 240 minutes in 5-minute increments.

 If the timer is already on, the timer will restart whenever the Timer Period is reset.

3. Press **▼** to highlight **Timer Display** and choose if you want the timer to show up on the screen by pressing **◀/▶**.

Selection	Description
Always	Displays the timer on screen throughout the presentation time.
1 min/2 min/3 min	Displays the timer on screen in the last 1/2/3 minute(s).
Never	Hides the timer throughout the presentation time.

4. Press **▼** to highlight **Timer Position** and set the timer position by pressing **◀/▶**.

**Top-Left → Bottom-Left → Top-Right → Bottom-Right**

5. Press **▼** to highlight **Timer Counting Direction** and select your desired counting direction by pressing **◀/▶**.

Selection	Description
Count Up	Increases from 0 to the preset time.
Count Down	Decreases from the preset time to 0.

6. Press **▼** to highlight **Sound Reminder** and decide if you want to activate sound reminder by pressing **◀/▶**. If you select **On**, a double beep sound will be heard at the last 30 seconds of counting down/up, and a triple beep sound will be produced when the timer is up.
7. To activate the presentation timer, press **▼** and press **◀/▶** to highlight **On** and press **MODE/ENTER**.
8. A confirmation message is displayed. Highlight **Yes** and press **MODE/ENTER** on the projector or remote control to confirm. You will see the message “**Timer is On**” displaying on the screen. The timer starts counting when the timer is on.

To cancel the timer, perform the following steps:

1. Go to the **SYSTEM SETUP: Basic > Presentation Timer** menu and highlight **Off**. Press **MODE/ENTER**. A confirmation message is displayed.
2. Highlight **Yes** and press **MODE/ENTER** to confirm. You will see the message “**Timer is Off**” appearing on the screen.

## Remote paging operations

Connect the projector to your PC or notebook with a USB cable prior to using the paging function. See “[Connection](#)” on page 17 for details.

You can operate your display software program (on a connected PC) which responds to page up/down commands (like Microsoft PowerPoint) by pressing **PAGE UP/PAGE DOWN** on the remote control.

If remote paging function doesn't work, check if the USB connection is correctly made and the mouse driver on your computer is updated to the latest version.

 The remote paging function cannot work with Microsoft® Windows®98 operating system. Windows®XP or higher operating systems are recommended.

## Freezing the image

Press **FREEZE** on the remote control to freeze the image. The word “**FREEZE**” will be displayed in the upper left corner of the screen. To release the function, press any key on the projector or remote control.

 If your remote control has the following keys, please note that they cannot be pressed to release the function: **LASER, #1, #4, PAGE UP/PAGE DOWN**.

Even if an image is frozen on the screen, the pictures are running on the video or other device. If the connected devices have active audio output, you will still hear the audio even though the image is frozen onscreen.

## Hiding the image

In order to draw the audience's full attention to the presenter, you can use **ECO BLANK** on the projector or remote control to hide the screen image. The word “**ECO BLANK**” appears in the corner of the screen while the image is hidden. When this function is activated with an audio input connected, the audio can still be heard.

You can set the blank time in the **SYSTEM SETUP: Basic > Operation Settings > Eco Blank Timer** menu to let the projector return the image automatically after a period of time when there is no action taken on the blank screen. The length of time can be set from 5 to 30 minutes in 5-minute increments.





If the preset time spans are not suitable for your presentation, select **Disable**.

No matter **Eco Blank Timer** is activated or not, you can press most of the keys on the projector or remote control to restore the picture.

 Do not block the projection lens from projecting as this could cause the blocking object to become heated and deformed or even cause a fire.

## Locking control keys

With the control keys on the projector locked, you can prevent your projector settings from being changed accidentally (by children, for example). When the **Panel Key Lock** is on, no control keys on the projector will operate except  **POWER**.

1. Go to the **SYSTEM SETUP: Basic > Panel Key Lock** menu, and select **On** by pressing / on the projector or remote control. A confirmation message is displayed.
  2. Highlight **Yes** and press **MODE/ENTER** to confirm.
- To release panel key lock, use the remote control to enter the **SYSTEM SETUP: Basic > Panel Key Lock** menu and press / to select **Off**.



- Keys on the remote control are still active when panel key lock is enabled.
- If you press  **POWER** to turn off the projector without disabling panel key lock, the projector will still be in locked status the next time it is turned on.





## Operating in a high altitude environment

We recommend you use the **High Altitude Mode** when your environment is between 1500 m –3000 m above sea level, and ambient temperature is between 0°C–35°C.



Do not use the **High Altitude Mode** if your altitude is between 0 m and 1500 m and ambient temperature is between 0°C and 35°C. The projector will be over cooled, if you turn the mode on under such a condition.

To activate the **High Altitude Mode**:

1. Press **MENU/EXIT** and then press / until the **SYSTEM SETUP: Advanced** menu is highlighted.
2. Press  to highlight **High Altitude Mode** and press / select **On**. A confirmation message is displayed.
3. Highlight **Yes** and press **MODE/ENTER**.

Operation under "**High Altitude Mode**" may cause a higher decibel operating noise level because of increased fan speed necessary to improve overall system cooling and performance.

If you use this projector under other extreme conditions excluding the above, it may display auto shut-down symptoms, which is designed to protect your projector from overheating. In cases like this, you should switch to High Altitude mode to solve these symptoms. However, this is not to state that this projector can operate under any and all harsh or extreme conditions.

## Creating your own startup screen

In addition to selecting the projector preset startup screen from among BenQ logo, Black or Blue screen, you can make your own startup screen that is a picture projected from your computer or video source.

To create your own startup screen, project the picture you want to use as your startup screen from either a computer or video source. The rest steps are as follows.

### • Using the remote control

1. Press **CAPTURE** on the remote control.
2. A confirmation message is displayed. Press **CAPTURE** or **MODE/ENTER** again.
3. The message '**Screen Capturing...**' is displayed while the projector is processing the picture. Please wait.

4. If the action is successful, you see the message '**Captured Succeeded**' on the screen. The captured picture is saved as **MyScreen**.
5. To view the captured picture displayed as the startup screen, set **MyScreen** in the **SYSTEM SETUP: Basic > Splash Screen** menu and restart the projector.

- **Using the OSD menu**

1. Press **MENU/EXIT** and then press ◀/▶ until the **SYSTEM SETUP: Basic** menu is highlighted.
2. Press ▼ to highlight **MyScreen** and press **MODE/ENTER**.
3. Repeat steps 2-5 in the "[Using the remote control](#)" section to capture and view the captured picture.

In the unlikely event that the capturing action fails, change your target picture.

## Adjusting the sound

The sound adjustments made as below will have an effect on the projector speakers. Be sure you have made a correct connection to the projector audio input. See "[Connection](#)" on page 17 for how the audio input is connected.

### Muting the sound

To temporarily turn off the sound:

1. Press **MENU/EXIT** and then press ◀/▶ until the **SYSTEM SETUP: Advanced** menu is highlighted.
2. Press ▼ to highlight **Audio Settings** and press **MODE/ENTER**. The **Audio Settings** page is displayed.
3. Highlight **Mute** and press ◀/▶ to select **On**.

 If available, you can also press **MUTE** on the remote control to toggle projector audio between on and off.

### Adjusting the sound level

To adjust the sound level, press **VOLUME+/VOLUME-** on the remote control, or:

1. Repeat steps 1-2 above.
2. Press ▼ to highlight **Volume** and press ◀/▶ to select a desired sound level.

### Adjusting the microphone volume

To adjust the microphone sound level, press **MIC/VOL** keys (+/-) on the remote control, or:

1. Repeat steps 1-2 above.
2. Press ▼ to highlight **Microphone Volume** and press ◀/▶ to select a desired sound level.

### Turning off the Power On/Off Ring Tone

To turn off the ring tone:

1. Repeat steps 1-2 above.
2. Press ▼ to highlight **Power On/Off Ring Tone** and press ◀/▶ to select **Off**.

 The only way to change **Power On/Off Ring Tone** is setting On or Off here. Setting the sound mute or changing the sound level will not affect the **Power On/Off Ring Tone**.

# Presenting from a USB Reader

This feature displays a slide show of images stored on a USB flash drive connected to the projector. It can eliminate the need for a computer source.

Supported image formats:

- JPEG(JPG)
- PNG
- TIFF
- BMP
- GIF
- PDF



- Not all PDF files can be displayed.
- A square box will be displayed on the filename for unidentified characters.
- Thai filename is not supported.
- Files in GIF, TIFF, PNG and BMP formats can be displayed for the file size smaller than WXGA (1280 x 800) only.
- If a folder consists of more than 200 photos, only the first 200 photos can be displayed.

To view your pictures as a slide show, follow these steps:

1. Plug the USB flash drive into the USB TYPE-A jack of the projector.
2. The projector automatically displays the thumbnails. Or you can manually select **USB Reader** from the source selection bar.

When viewing thumbnails

To	Press
open a folder	Enter
scroll through thumbnails	four arrow keys
return to a previous page	Auto
exit USB Reader	Exit
change to a different page	◀/▶
go back to the first page of that folder	Back
start a slide show	Slideshow when an image is highlighted.
adjust USB Reader settings	Setting

## During a slide show

To	Press
go to previous or next image	◀/▶
rotate the image by 90 degree clockwise/ counterclockwise	▲/▼ (Rotation is temporary; the image returns to its original orientation when you go back to thumbnails)
return to a previous page	Auto
start/stop a slide show	Enter

## Setting page

You can adjust the file order and Slideshow settings. When you are done, press OK to save the settings or press Cancel to ignore the change.

## Shutting down the projector

1. Press **POWER** or **OFF**, and a confirmation message will be displayed prompting you.  
If you don't respond in a few seconds, the message will disappear.
2. Press **POWER** or **OFF** a second time. The **POWER indicator light** flashes orange, the light source shuts down.
3. A "**Power Off Ring Tone**" will be heard. The **POWER indicator light** is a steady orange and fans stop. Disconnect the power cord from the power outlet.

- To turn off the power ring tone, see "[Turning off the Power On/Off Ring Tone](#)" on page 36 for details.
- Light source life results will vary depending on environmental conditions and usage.

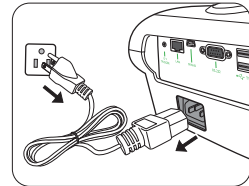

## Direct power off

The AC power cord can be pulled out right after the projector is turned off.

# Menu operation

## Menu system

Please note that the on-screen display (OSD) menus vary according to the signal type selected and the projector model you are using.

Main menu	Sub-menu	Options	
<b>1. DISPLAY</b>	Wall Color	Off/Light Yellow/Pink/Light Green/Blue/Blackboard	
	Aspect Ratio	Auto/Real/4:3/16:9/16:10	
	Auto Keystone	On/Off	
	Keystone		
	Position		
	Phase		
	H. Size		
	Digital Zoom		
	3D Sync	Off/Frame Sequential/Top-Bottom	
	3D Sync Invert	Disable/Invert	
	Teaching Template	Blackboard Whiteboard	Off/Letter Formation/Worksheet/Coordinate Chart Off/Letter Formation/Worksheet/Coordinate Chart
<b>2. PICTURE</b>	Picture Mode	Dynamic/Presentation/sRGB/Cinema/User 1/User 2	
	Reference Mode	Dynamic/Presentation/sRGB/Cinema	
	Brightness		
	Contrast		
	Color		
	Tint		
	Sharpness		
	Brilliant Color	On/Off	
	Color Temperature	Cool/Normal/Warm	
	3D Color Management	Primary Color	R/G/B/C/M/Y
		Hue	
	Saturation	Saturation	
		Gain	
Save Settings			
<b>3. SOURCE</b>	Quick Auto Search	On/Off	
	Color Space Conversion	Auto/RGB/YUV	
<b>4. SYSTEM SETUP: Basic</b>	Presentation Timer	Timer Period	1~240 minutes
		Timer Display	Always/1 min/2 min/3 min/Never
		Timer Position	Top-Left/Bottom-Left/Top-Right/Bottom-Right
		Timer Counting Direction	Count Down/Count Up
		Sound Reminder	On/Off
		On/Off	





Main menu	Sub-menu	Options	
<b>4. SYSTEM SETUP: Basic</b>	<b>Language</b>	English/Français/Deutsch Italiano/Español/Русский 繁體中文/简体中文/日本語/한국어/ Svenska/Nederlands/Türkçe/ Čeština/Português/ ལྷོ / Polski/ Magyar/Hrvatski/Română/ Norsk/Dansk/Български/ Suomi/Indonesian/Ελληνικά/ العربية / हिन्दी	
	<b>Projector Position</b>	<b>Front Table/Rear Table/Rear Ceiling/Front Ceiling</b>	
	<b>Menu Settings</b>	<b>Menu Display Time</b>	5 sec/10 sec/15 sec/20 sec/25 sec/30 sec
		<b>Menu Position</b>	Center/Top-Left/Top-Right/Bottom-Right/Bottom-Left
		<b>Reminder Message</b>	<b>On/Off</b>
	<b>Operation Settings</b>	<b>Direct Power On</b>	<b>On/Off</b>
		<b>Signal Power On</b>	<b>On/Off</b>
		<b>Auto Power Off</b>	<b>Disable/5 min/10 min/15 min/20 min/25 min/30 min</b>
		<b>Eco Blank Timer</b>	<b>Disable/5 min/10 min/15 min/20 min/25 min/30 min</b>
		<b>Sleep Timer</b>	<b>Disable/30 min/1 hr/2 hr/3 hr/4 hr/8 hr/12 hr</b>
	<b>Remote Receiver</b>	<b>Front+Rear/Front/Rear</b>	
	<b>Panel Key Lock</b>	<b>On/Off</b>	
	<b>Background Color</b>	<b>BenQ/Black/Blue/Purple</b>	
	<b>Splash Screen</b>	<b>BenQ/Black/Blue//MyScreen</b>	
<b>MyScreen</b>			
<b>5. SYSTEM SETUP: Advanced</b>	<b>High Altitude Mode</b>	<b>On/Off</b>	
	<b>Audio Settings</b>	<b>Mute</b>	<b>On/Off</b>
		<b>Volume</b>	
		<b>Microphone Volume</b>	
		<b>Power On/Off</b>	<b>On/Off</b>
		<b>Ring Tone</b>	
	<b>Light Source Adjustments</b>	<b>Light Source Mode Selection</b>	<b>Normal/Economic/SMART ECO/Manual</b>
		<b>Reset Light Source Timer</b>	
		<b>Equivalent Light Source Hour</b>	
	<b>Security Settings</b>	<b>Change Password</b>	
		<b>Change Security Settings</b>	<b>Power On Lock</b>
<b>Splash Screen Lock</b>			
<b>Web Control Lock</b>			







Main menu	Sub-menu	Options	
<b>5. SYSTEM SETUP: Advanced</b>	<b>Baud Rate</b>	2400/4800/9600/14400/19200/ 38400/57600/115200	
	<b>Test Pattern</b>	<b>On/Off</b>	
	<b>Closed Caption</b>	<b>Closed Caption Enable</b>	<b>On/Off</b>
		<b>Caption Version</b>	CC1/CC2/CC3/CC4
	<b>Standby Settings</b>	<b>Network</b>	<b>On/Off</b>
		<b>Microphone</b>	<b>On/Off</b>
		<b>Monitor Out</b>	<b>On/Off</b>
		<b>Audio Pass Through</b>	<b>Off/Computer1/Computer2/ Video,S-Video/HDMI/Network display/USB display</b>
	<b>Network Settings</b>	<b>Wired LAN</b>	<b>Status</b>
			<b>DHCP</b>
			<b>IP Address</b>
			<b>Subnet Mask</b>
			<b>Default Gateway</b>
			<b>DNS Server</b>
			<b>Apply</b>
		<b>Wireless LAN</b>	<b>Status</b>
			<b>SSID</b>
			<b>SSID Display</b>
			<b>Connection Mode</b>
			<b>Apply</b>
		<b>Remote Desktop</b>	<b>Account</b>
			<b>Password</b>
		<b>Connect</b>	
<b>Broadcasting</b>	<b>On/Off</b>		
<b>Projection Log In Code</b>	<b>On/Off</b>		
<b>AMX Device Discovery</b>	<b>On/Off</b>		
<b>Mac Address</b>			
	<b>Reset All Settings</b>		
<b>6. INFORMATION</b>	<b>Current System Status</b>	<ul style="list-style-type: none"> <li>• <b>Source</b></li> <li>• <b>Picture Mode</b></li> <li>• <b>Resolution</b></li> <li>• <b>Color System</b></li> <li>• <b>Equivalent Light Source</b></li> </ul> <b>Hour</b> <ul style="list-style-type: none"> <li>• <b>Firmware Version</b></li> </ul>	



Note that the menu items are available when the projector detects at least one valid signal. If there is no equipment connected to the projector or no signal detected, limited menu items are accessible.

# Description of each menu



Function	Description
<b>I. DISPLAY menu</b>	<p><b>Wall Color</b></p> <p>Corrects the projected picture's color when the projection surface is not white. See <a href="#">"Using Wall Color" on page 30</a> for details.</p>
	<p><b>Aspect Ratio</b></p> <p>There are several options to set the image's aspect ratio depending on your input signal source. See <a href="#">"Selecting the aspect ratio" on page 28</a> for details.</p>
	<p><b>Auto Keystone</b></p> <p>Automatically corrects any keystone of the image. See <a href="#">"Correcting keystone" on page 22</a> for details.</p>
	<p><b>Keystone</b></p> <p>Corrects any keystone of the image. See <a href="#">"Correcting keystone" on page 22</a> for details.</p>
	<p><b>Position</b></p> <p>Displays the position adjustment page. To move the projected image, use the directional arrow keys. The values shown on the lower position of the page change with every key press you made until they reach their maximum or minimum.</p> <p> This function is only available when a PC signal (analog RGB) is selected.</p>
	<p><b>Phase</b></p> <p>Adjusts the clock phase to reduce image distortion.</p> <p> This function is only available when a PC signal (analog RGB) is selected.</p> 
	<p><b>H. Size</b></p> <p>Adjusts the horizontal width of the image.</p> <p> This function is only available when a PC signal (analog RGB) is selected.</p>
	<p><b>Digital Zoom</b></p> <p>Magnifies or reduces the projected image. See <a href="#">"Magnifying and searching for details" on page 28</a> for details.</p>
	<p><b>3D Sync</b></p> <p>This projector features a 3D function which enables you to enjoy the 3D movies, videos, and sporting events in a more realistic way by presenting the depth of the images. You need to wear a pair of 3D glasses to view the 3D images.</p> <p>Video timing: 480i</p> <p>PC timing: up to 1280x800@120Hz for <b>Frame Sequential</b></p> <p>PC timing: up to 1280x800@60Hz for <b>Frame Sequential</b></p> <p>PC timing: up to SXGA+@60Hz for <b>Top-Bottom</b></p> <p> When the <b>3D Sync</b> function is <b>On</b>:</p> <ul style="list-style-type: none"> <li>• The brightness level of the projected image will decrease.</li> <li>• The <b>Picture Mode</b> cannot be adjusted.</li> <li>• The <b>Keystone</b> can only be adjusted within limited degrees.</li> </ul>
	<p><b>3D Sync Invert</b></p> <p>When you discover the inversion of the image depth, enable this function to correct the problem.</p>

Function	Description
<b>I. DISPLAY menu</b>  <b>Teaching Template</b>	<p>Provides several preset patterns for various teaching purposes.</p> <p>Choose <b>Blackboard</b> or <b>Whiteboard</b> first by pressing ▲/ ▼ and press ◀/ ▶ to choose the pattern you need. Press <b>MODE/ENTER</b> to display the selected pattern.</p>
<b>2. PICTURE menu</b>	<b>Picture Mode</b> Pre-defined picture modes are provided so you can optimize your projector image set-up to suit your program type. See " <a href="#">Selecting a picture mode</a> " on page 30 for details.
	<b>Reference Mode</b> Selects a picture mode that best suits your need for the image quality and further fine-tune the image based on the selections listed on the same page below. See " <a href="#">Setting the User 1/User 2 mode</a> " on page 30 for details.
	<b>Brightness</b> Adjusts the brightness of the image. See " <a href="#">Adjusting Brightness</a> " on page 31 for details.
	<b>Contrast</b> Adjusts the degree of difference between dark and light in the image. See " <a href="#">Adjusting Contrast</a> " on page 31 for details.
	<b>Color</b> Adjusts the color saturation level -- the amount of each color in a video image. See " <a href="#">Adjusting Color</a> " on page 31 for details.  This function is only available when a Video, S-Video or Component Video signal is selected.
	<b>Tint</b> Adjusts the red and green color tones of the image. See " <a href="#">Adjusting Tint</a> " on page 31 for details.  This function is only available when a Video or S-Video signal is selected and the system format is NTSC.
	<b>Sharpness</b> Adjusts the image to make it look sharper or softer. See " <a href="#">Adjusting Sharpness</a> " on page 31 for details.  This function is only available when a Video, S-Video or Component Video signal is selected.
	<b>Brilliant Color</b> See " <a href="#">Adjusting Brilliant Color</a> " on page 31 for details.
	<b>Color Temperature</b> There are four color temperature settings available. See " <a href="#">Selecting a color temperature</a> " on page 31 for details.
	<b>3D Color Management</b> See " <a href="#">3D Color Management</a> " on page 32 for details.
<b>Save Settings</b> Saves the settings made for <b>User 1</b> or <b>User 2</b> mode.	

	Function	Description	
<b>3. SOURCE</b>	<b>Quick Auto Search</b>	See <a href="#">"Switching input signal" on page 27</a> for details.	
	<b>Color Space Conversion</b>	See <a href="#">"Changing Color Space" on page 27</a> for details.	
<b>4. SYSTEM SETUP: Basic</b>	<b>Presentation Timer</b>	Reminds the presenter to finish the presentation within a certain time frame. See <a href="#">"Setting the presentation timer" on page 33</a> for details.	
	<b>Language</b>	Sets the language for the On-Screen Display (OSD) menus. See <a href="#">"Using the menus" on page 23</a> for details.	
	<b>Projector Position</b>	The projector can be installed on a ceiling or behind a screen, or with one or more mirrors. See <a href="#">"Choosing a location" on page 14</a> for details.	
	<b>Menu Settings</b>	<b>Menu Display Time</b>	Sets the length of time the OSD will remain active after your last key press.
		<b>Menu Position</b>	Sets the On-Screen Display (OSD) menu position.
<b>Reminder Message</b>		Sets the reminder messages on or off.	
<b>Operation Settings</b>	<p><b>Direct Power On</b> Allows the projector to turn on automatically once the power is fed through the power cord.</p> <p><b>Signal Power On</b> Sets whether to turn the projector directly on without pressing  <b>POWER</b> or  <b>ON</b> when the projector is in standby mode and the signal is feed through the VGA cable.</p> <p><b>Auto Power Off</b> Allows the projector to turn off automatically if no input signal is detected after a set period of time. See <a href="#">"Setting Auto Power Off" on page 49</a> for details.</p> <p><b>Eco Blank Timer</b> Sets the image blank time when the Blank feature is activated, once elapsed the image will return to the screen. See <a href="#">"Hiding the image" on page 34</a> for details.</p> <p><b>Sleep Timer</b> Sets the auto-shutdown timer.</p>		

	Function	Description
4. SYSTEM SETUP: Basic menu	<b>Remote Receiver</b>	Allows you to enable all the remote receivers or one specific remote receiver on the projector.
	<b>Panel Key Lock</b>	Disables or enables all panel key functions except  <b>POWER</b> on the projector and keys on the remote control. See <a href="#">"Locking control keys" on page 35</a> for details.
	<b>Background Color</b>	Sets the background color for the projector.
	<b>Splash Screen</b>	Allows you to select which logo screen will display during projector start-up.
	<b>MyScreen</b>	Captures and stores the projected picture as My Screen. See <a href="#">"Creating your own startup screen" on page 35</a> for details.   In the unlikely event that the capturing action fails, change your target picture.
5. SYSTEM SETUP: Advanced menu	<b>High Altitude Mode</b>	A mode for operation in high altitude areas. See <a href="#">"Operating in a high altitude environment" on page 35</a> for details.
	<b>Audio Settings</b>	<b>Mute</b> <b>Volume</b> <b>Microphone Volume</b> <b>Power On/Off Ring Tone</b> See <a href="#">"Adjusting the sound" on page 36</a> for details.
	<b>Light Source Adjustments</b>	<b>Light Source Mode Selection</b> See <a href="#">"Setting Light Source Mode Selection as Economic" on page 49</a> for details.  <b>Reset Light Source Timer</b> Please consult your dealer on when and how to reset the light source timer.  <b>Equivalent Light Source Hour</b> See <a href="#">"Getting to know the light source hour" on page 49</a> for details on how the total light source hour is calculated.
	<b>Security Settings</b>	<b>Change Password</b> You will be asked to enter the current password before changing to a new one. See <a href="#">"Utilizing the password function" on page 24</a> for details.  <b>Change Security Settings</b> <b>Power On Lock</b> <b>Splash Screen Lock</b> See <a href="#">"Utilizing the password function" on page 24</a> for details.  <b>Web Control Lock</b> See <a href="#">BenQ Network Projector Operation Guide</a> for details.

Function	Description
5. SYSTEM SETUP: Advanced menu	<p><b>Baud Rate</b></p> <p>Selects a baud rate that is identical with your computer's so that you can connect the projector using a suitable RS-232 cable and update or download the projector's firmware. This function is intended for qualified service personnel.</p>
	<p><b>Test Pattern</b></p> <p>Selecting <b>On</b> enables the function and the projector displays the grid test pattern. It helps you adjust the image size and focus and check that the projected image is free from distortion.</p>
	<p><b>Closed Caption</b></p> <p><b>Closed Caption Enable</b> Activates the function by selecting <b>On</b> when the selected input signal carries closed captions.</p> <ul style="list-style-type: none"> <li>• Captions: An on-screen display of the dialogue, narration, and sound effects of TV programs and videos that are closed captioned (usually marked as "CC" in TV listings).</li> </ul> <p><b>Caption Version</b> Selects a preferred closed captioning mode. To view captions, select CC1, CC2, CC3, or CC4 (CC1 displays captions in the primary language in your area).</p>
	<p><b>Standby Settings</b></p> <p><b>Network</b> Selecting <b>On</b> enables the function. The projector is able to provide the network function when it is in standby mode.</p> <p><b>Microphone</b> Selecting <b>On</b> enables the function. The projector can output the microphone signal when it is in standby mode and all the necessary equipment is correctly connected. See "<a href="#">Playing sound through the projector</a>" on page 18 for details.</p> <p><b>Monitor Out</b> Selecting <b>On</b> enables the function. The projector can output a VGA signal when it is in standby mode and the <b>COMPUTER 1</b> jack is correctly connected to devices. See "<a href="#">Connection</a>" on page 17 for how to make the connection.</p> <p><b>Audio Pass Through</b> The projector can play sound when it is in standby mode and the corresponding jacks are correctly connected to devices. Press ◀/▶ to choose the source that you wish to use.</p> <p>See "<a href="#">Connection</a>" on page 17 for how to make the connection.</p> <p> Enabling this function slightly increases the standby power consumption.</p>

Function	Description
SYSTEM SETUP: Advanced menu	<p><b>Network Settings</b></p> <p><b>Wired LAN</b>  <b>Wireless LAN</b>  <b>Remote Desktop</b>  <b>Broadcasting</b>  <b>Projection Log In Code</b>  See <a href="#">BenQ Network Projector Operation Guide</a> for details.</p> <p><b>AMX Device Discovery</b>  When <b>AMX Device Discovery</b> is <b>On</b>, the projector can be detected by AMX controller.</p> <p><b>Mac Address</b>  Displays the mac address for this projector.</p> <p> The System limitation of I:I audio is Intel Pentium 4, 3.0G CPU, 1G RAM.</p>
	<p><b>Reset All Settings</b></p> <p>Returns all settings to the factory preset values.</p> <p> The following settings will still remain: <b>Phase, H. Size, User 1, User 2, Color Space Conversion, Language, Projector Position, High Altitude Mode, Security Settings, DHCP, SSID, Remote Desktop and Baud Rate.</b></p>
6. INFORMATION menu	<p><b>Current System Status</b></p> <p><b>Source</b>  Shows the current signal source.</p> <p><b>Picture Mode</b>  Shows the selected mode in the <b>PICTURE</b> menu.</p> <p><b>Resolution</b>  Shows the native resolution of the input signal.</p> <p><b>Color System</b>  Shows input system format: NTSC, PAL, SECAM, YUV, or RGB.</p> <p><b>Equivalent Light Source Hour</b>  Displays the number of hours the light source has been used.</p> <p><b>Firmware Version</b>  Shows the firmware version of your projector.</p>

# Maintenance

## Care of the projector

Your projector needs little maintenance. The only thing you need to do on a regular basis is to keep the lens and case clean.

Never remove any parts of the projector. Contact your dealer if any part needs replacing.

### Cleaning the lens

Clean the lens whenever you notice dirt or dust on the surface.

- Use a canister of compressed air to remove dust.
- If there is dirt or smears, use lens-cleaning paper or moisten a soft cloth with lens cleaner and gently wipe the lens surface.
- Never use any type of abrasive pad, alkaline/acid cleaner, scouring powder, or volatile solvent, such as alcohol, benzene, thinner or insecticide. Using such materials or maintaining prolonged contact with rubber or vinyl materials may result in damage to the projector surface and cabinet material.

### Cleaning the projector case

Before you clean the case, turn the projector off using the proper shutdown procedure as described in "[Shutting down the projector](#)" on page 38 and unplug the power cord.

- To remove dirt or dust, wipe the case with a soft, lint-free cloth.
- To remove stubborn dirt or stains, moisten a soft cloth with water and a neutral pH detergent. Then wipe the case.

 Never use wax, alcohol, benzene, thinner or other chemical detergents. These can damage the case.

### Storing the projector

If you need to store the projector for an extended time, please follow the instructions below:

- Make sure the temperature and humidity of the storage area are within the recommended range for the projector. Please refer to "[Specifications](#)" on page 53 or consult your dealer about the range.
- Retract the adjuster feet.
- Remove the batteries from the remote control.
- Pack the projector in its original packing or equivalent.

### Transporting the projector

It is recommended that you ship the projector with its original packing or equivalent. When you carry the projector yourself, please use the original box or equivalent.



# Light source information

## Getting to know the light source hour

When the projector is in operation, the duration (in hours) of light source usage is automatically calculated by the built-in timer.

 See "[Setting Light Source Mode Selection as Economic](#)" below for more information on **Economic** mode.

To obtain the light source hour information:

1. Press **MENU/EXIT** and then press **◀/▶** to highlight the **SYSTEM SETUP: Advanced** menu.
2. Press **▼** to highlight **Light Source Adjustments** and press **MODE/ENTER**. The **Light Source Adjustments** page is displayed.
3. You will see the **Equivalent Light Source Hour** information appearing on the menu.
4. To leave the menu, press **MENU/EXIT**.

You can also get the light source hour information on the **INFORMATION** menu.

## Extending light source life

The light source is a consumable item that normally can last up to 10000-20000 hours with proper usage. To keep the light source life as long as possible, you can do the following settings via the OSD menu.

- **Setting Light Source Mode Selection as Economic**

Using **Economic** mode reduces system noise and power consumption by 20%. If the **Economic** mode is selected, the light output will be reduced and result in darker projected pictures.

Setting the projector in **Economic** mode also extends the light source operation life. To set **Economic** mode, go into the **SYSTEM SETUP: Advanced > Light Source Adjustments > Light Source Mode Selection** menu and press **◀/▶**.

- **Setting Auto Power Off**

This function allows the projector to turn off automatically if no input signal is detected after a set period of time to prevent unnecessary waste of light source life.

To set **Auto Power Off**, go into the **SYSTEM SETUP: Basic > Operation Settings > Auto Power Off** menu and press **◀/▶**. The time period can be set from 5 to 30 minutes in 5-minute increments. If the preset time lengths are not suitable for your presentation, select **Disable**. The projector will not automatically shut down in a certain time period.

## Timing of replacing the light source

When the **Light indicator** lights up red or a message appears suggesting it is time to replace the light source, please consult your dealer.

The following light source warning displays will remind you to change the light source.

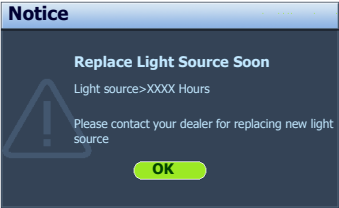
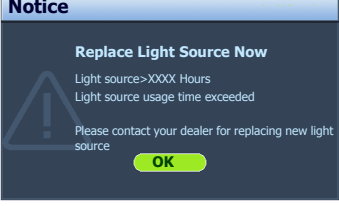
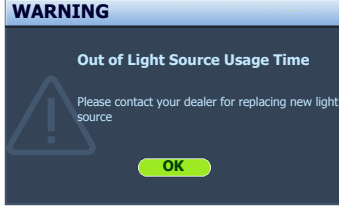
Status	Message
<p>Install a new light source for optimal performance. If the projector is normally run with <b>Economic</b> selected (See "<a href="#">Getting to know the light source hour</a>" on page 49), you may continue to operate the projector until the next hour light source warning appears.</p> <p>Press <b>ENTER</b> to dismiss the message.</p>	 <p><b>Notice</b></p> <p><b>Order Replacement Light Source</b> Light source&gt;XXXX Hours</p> <p>Please contact your dealer for replacing new light source</p> <p><b>OK</b></p>
<p>It is strongly recommended that you replace the light source at this age. The light source is a consumable item. The light source brightness diminishes with use. This is normal light source behavior. You can replace the light source whenever you notice that the brightness level has significantly diminished.</p> <p>Press <b>ENTER</b> to dismiss the message.</p>	 <p><b>Notice</b></p> <p><b>Replace Light Source Soon</b> Light source&gt;XXXX Hours</p> <p>Please contact your dealer for replacing new light source</p> <p><b>OK</b></p>  <p><b>Notice</b></p> <p><b>Replace Light Source Now</b> Light source&gt;XXXX Hours Light source usage time exceeded</p> <p>Please contact your dealer for replacing new light source</p> <p><b>OK</b></p>
<p>The light source <b>MUST</b> be replaced before the projector will operate normally.</p> <p>Press <b>ENTER</b> to dismiss the message.</p>	 <p><b>WARNING</b></p> <p><b>Out of Light Source Usage Time</b></p> <p>Please contact your dealer for replacing new light source</p> <p><b>OK</b></p>

 "XXXX" shown in the above messages are numbers that vary depending on different models.

## Replacing the light source

 **Do not replace the light source by yourself. Please contact your dealer.**

# Indicators

Light			Status & Description
LIGHT	TEMP	POWER	
<b>Power events</b>			
<b>Off</b>	<b>Off</b>	<b>Orange</b>	Stand-by mode.
<b>Off</b>	<b>Off</b>	<b>Green Flashing</b>	Powering up.
<b>Off</b>	<b>Off</b>	<b>Green</b>	Normal operation.
<b>Off</b>	<b>Off</b>	<b>Orange Flashing</b>	<ul style="list-style-type: none"> <li>The projector needs to cool for 5 seconds after the power is turned off.</li> <li>The projector has shut down automatically. If you try to re-start the projector, it will shut down again. Please contact your dealer for assistance.</li> </ul>
<b>Thermal events</b>			
<b>Off</b>	<b>Red</b>	<b>Off</b>	The projector has shut down automatically. If you try to re-start the projector, it will shut down again. Please contact your dealer for assistance.
<b>Red</b>	<b>Red</b>	<b>Off</b>	
<b>Green</b>	<b>Red</b>	<b>Off</b>	
<b>Orange</b>	<b>Red</b>	<b>Off</b>	
<b>Red</b>	<b>Red</b>	<b>Orange</b>	
<b>Green</b>	<b>Red</b>	<b>Orange</b>	
<b>Red</b>	<b>Red</b>	<b>Red</b>	
<b>Green</b>	<b>Red</b>	<b>Red</b>	
<b>Red</b>	<b>Red</b>	<b>Green</b>	
<b>Green</b>	<b>Red</b>	<b>Green</b>	
<b>Red</b>	<b>Green</b>	<b>Off</b>	
<b>Orange</b>	<b>Green</b>	<b>Off</b>	
<b>Red</b>	<b>Orange</b>	<b>Off</b>	

# Troubleshooting

## ? The projector does not turn on.

Cause	Remedy
There is no power from the power cord.	Plug the power cord into the AC power jack on the projector, and plug the power cord into the power outlet. If the power outlet has a switch, make sure that it is switched on.

## ? No picture

Cause	Remedy
The video source is not turned on or connected correctly.	Turn the video source on and check that the signal cable is connected correctly.
The projector is not correctly connected to the input signal device.	Check the connection.
The input signal has not been correctly selected.	Select the correct input signal with the <b>SOURCE</b> key on the projector or remote control.
The lens cover is still closed.	Open the lens cover.

## ? Blurred image

Cause	Remedy
The projection lens is not correctly focused.	Adjust the focus of the lens using the focus ring.
The projector and the screen are not aligned properly.	Adjust the projection angle and direction as well as the height of the projector if necessary.
The lens cover is still closed.	Open the lens cover.

## ? Remote control does not work

Cause	Remedy
The batteries are out of power.	Replace the batteries with new ones.
There is an obstacle between the remote control and the projector.	Remove the obstacle.
You are too far away from the projector.	Stand within 8 meters (26 feet) of the projector.

## ? The password is incorrect

Cause	Remedy
You do not remember the password.	Please see <a href="#">"Entering the password recall procedure" on page 25</a> for details.

# Specifications

## Projector specifications

 All specifications are subject to change without notice.

### Optical

Resolution  
(LX60ST)  
1024 x 768 XGA  
(LW61ST)  
1280 x 800 WXGA  
Display system  
1-CHIP DMD  
Lens F/Number  
F = 2.59  
Light source  
Blue Laser Diode x 24

### Electrical

Power supply  
AC100–240V, 2.22 A, 50-60 Hz (Automatic)  
Power consumption  
270 W (Max); < 0.5 W (Standby)

### Mechanical

Weight  
11.24 lbs (5.1 Kg)

### Output terminals

RGB output  
D-Sub 15-pin (female) x 1  
Speaker  
(Stereo) 10 watt x 2  
Audio signal output  
PC audio jack x 1

### Control

RS-232 serial control  
9 pin x 1  
LAN control  
RJ45 x 1  
IR receiver x 2  
12V trigger x 1 (Max. 1A)

### Input terminals

Computer input  
RGB input  
D-Sub 15-pin (female) x 2  
Video signal input  
S-VIDEO  
Mini DIN 4-pin port x 1  
VIDEO  
RCA jack x 1  
SD/HDTV signal input  
Analog - Component RCA jack x 3  
(through RGB input)  
Digital - HDMI V1.3 x 1  
Audio signal input  
Audio in  
PC audio jack x 2  
RCA audio jack (L/R) x 2  
Microphone x 1  
USB ports (Type-A x 2; Mini-B x 1)

### Environmental Requirements

Operating temperature  
0°C–40°C at sea level  
Operating relative humidity  
10%–90% (without condensation)  
Operating altitude  
0–1499 m at 0°C–35°C  
1500–3000 m at 0°C–30°C (with  
High Altitude Mode on)

# Dimensions

393 mm (W) x 117 mm (H) x 298 mm (D)

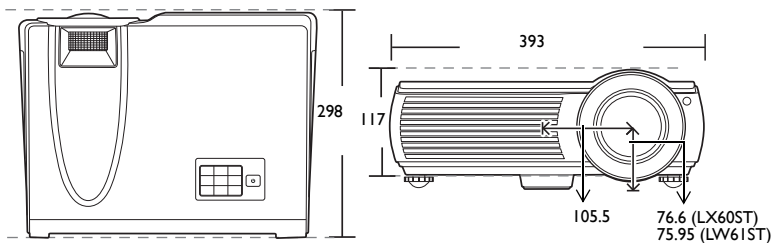

## Wall mount installation

### Minimum installation requirements

#### LX60ST

Computer Resolution: XGA Image Resolution: XGA	Diagram Reference	SMART Board 660	SMART Board 680	Promethean ActivBoard 164	Promethean ActivBoard 178	RM CkassBiard2 77.5	Hitachi StarBoard FX-63	StarBoard FX-77
Image Diagonal (inches)	D	64	77	64	78	77.5	63	77
Image Height (mm)	H	975	1173	975	1189	1881	960	1173
Image Width (mm)	W	1300	1565	1300	1585	1575	1280	1565
Distance from floor to bottom of image (mm)	f	900	900	900	900	900	900	900
Distance from screen surface to projector lens (mm)	a	790	951	790	963	957	778	951
Distance from top case to the top of image (mm)	b	78.6	108.6	78.6	110.6	109.6	76.6	108.6

Distance from top of wall mount to ceiling (mm)	c	50	50	50	50	50	50	50
Minimum Ceiling Height (mm)	e	2337.6	2565.6	2337.6	2583.6	3274.6	2320.6	2565.6

## LW61ST

Computer Resolution: WXGA Image Resolution: WXGA	Diagram Reference	SMART Board 685	Promethean ActivBoard 387	Hitachi FX-TRIO-88W	Hitachi FX-DUO-88W
Image Diagonal (inches)	D	87	87	88	88
Image Height (mm)	H	1171	1171	1185	1185
Image Width (mm)	W	1874	1874	1898	1895
Distance from floor to bottom of image (mm)	f	900	900	900	900
Distance from screen surface to projector lens (mm)	a	916	916	926	926
Distance from top case to the top of image(mm)	b	-9.49	-9.49	-8.82	-8.82
Distance from top of wall mount to ceiling (mm)	c	50	50	50	50
Minimum Ceiling Height (mm)	e	2445.5	2445.5	2460.2	2460.2

$$\text{Minimum Ceiling Height (mm)} = f + H + b + 60 + 274 + c$$

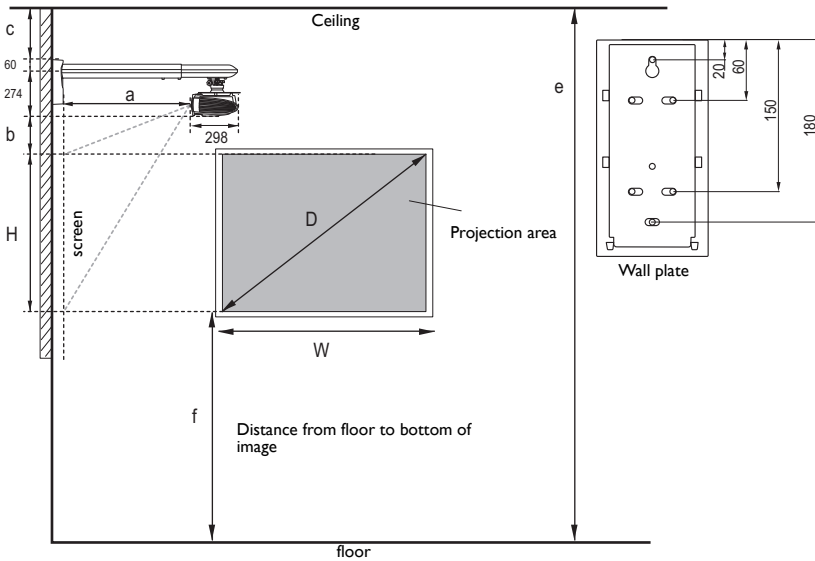

- The dimensions are based on the BenQ wall mount (P/N: 5JJ4R10.001).
- All measurements are approximate and may vary from the actual sizes. BenQ recommends that if you intend to permanently install the projector, you should physically test the projection size and distance using the actual projector in situ before you permanently install it, so as to make allowance for this projector's optical characteristics. This will help you determine the exact mounting position so that it best suits your installation location.
- The dimensions supplied are offered as a guide only and may differ depending on several factors relating to any specific installation.
- The dimensions are based on the projector being configured with zero keystone correction.
- The dimensions assume that the wall mount arm is positioned 90° from the bottom case of projector and screen surface.

### Ceiling mount screw:

M4 x 8 (Max L = 8 mm)

Unit: mm

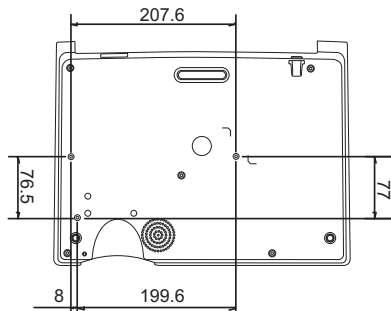



# Timing chart

## Supported timing for PC input

Resolution	Mode	Vertical Frequency (Hz)	Horizontal Frequency (kHz)	Pixel Frequency (MHz)
640 x 480	VGA_60	59.940	31.469	25.175
	VGA_72	72.809	37.861	31.500
	VGA_75	75.000	37.500	31.500
	VGA_85	85.008	43.269	36.000
720 x 400	720 x 400_70	70.087	31.469	28.3221
800 x 600	SVGA_60*	60.317	37.879	40.000
	SVGA_72	72.188	48.077	50.000
	SVGA_75	75.000	46.875	49.500
	SVGA_85	85.061	53.674	56.250
	SVGA_120** (Reduce Blanking)	119.854	77.425	83.000
1024 x 768	XGA_60*	60.004	48.363	65.000
	XGA_70	70.069	56.476	75.000
	XGA_75	75.029	60.023	78.750
	XGA_85	84.997	68.667	94.500
	XGA_120** (Reduce Blanking)	119.989	97.551	115.5
1152 x 864	1152 x 864_75	75	67.5	108
1280 x 720	1280 x 720_60*	60	45.000	74.250
1280 x 768	1280 x 768_60*	59.87	47.776	79.5
1024 x 576	BenQ Notebook Timing	60.0	35.820	46.966
1024 x 600	BenQ Notebook Timing	64.995	41.467	51.419
1280 x 800	WXGA_60*	59.810	49.702	83.500
	WXGA_75	74.934	62.795	106.500
	WXGA_85	84.880	71.554	122.500
	WXGA_120** (Reduce Blanking)	119.909	101.563	146.25
1280 x 1024	SXGA_60***	60.020	63.981	108.000
	SXGA_75	75.025	79.976	135.000
	SXGA_85	85.024	91.146	157.500
1280 x 960	1280 x 960_60***	60.000	60.000	108
	1280 x 960_85	85.002	85.938	148.500
1360 x 768	1360 x 768_60***	60.015	47.712	85.500
1440 x 900	WXGA+_60***	59.887	55.935	106.500
1400 x 1050	SXGA+_60***	59.978	65.317	121.750
1600 x 1200	UXGA	60.000	75.000	162.000
1680 x 1050	1680x1050_60	59.954	65.29	146.25
640 x 480@67Hz	MAC13	66.667	35.000	30.240
832 x 624@75Hz	MAC16	74.546	49.722	57.280
1024 x 768@75Hz	MAC19	75.020	60.241	80.000
1152 x 870@75Hz	MAC21	75.06	68.68	100.00

 \*Supported timing for non-3D and 3D signal with **Frame Sequential** and **Top-Bottom** format.

\*\*Supported timing for non-3D and 3D signal with **Frame Sequential** format.

\*\*\*Supported timing for non-3D and 3D signal with **Top-Bottom** format.

## Supported timing for HDMI (HDCP) input

Resolution	Mode	Vertical Frequency (Hz)	Horizontal Frequency (kHz)	Pixel Frequency (MHz)
640 x 480	VGA_60	59.940	31.469	25.175
	VGA_72	72.809	37.861	31.500
	VGA_75	75.000	37.500	31.500
	VGA_85	85.008	43.269	36.000
720 x 400	720 x 400_70	70.087	31.469	28.3221
800 x 600	SVGA_60*	60.317	37.879	40.000
	SVGA_72	72.188	48.077	50.000
	SVGA_75	75.000	46.875	49.500
	SVGA_85	85.061	53.674	56.250
	SVGA_120** (Reduce Blanking)	119.854	77.425	83.000
1024 x 768	XGA_60*	60.004	48.363	65.000
	XGA_70	70.069	56.476	75.000
	XGA_75	75.029	60.023	78.750
	XGA_85	84.997	68.667	94.500
	XGA_120** (Reduce Blanking)	119.989	97.551	115.5
1152 x 864	1152 x 864_75	75	67.5	108
1280 x 768	1280 x 768_60	59.87	47.776	79.5
1024 x 576@60Hz	BenQ Notebook Timing	60.00	35.820	46.996
1024 x 600@65Hz	BenQ Notebook Timing	64.995	41.467	51.419
1280 x 720	1280 x 720_60*	60	45.000	74.250
1280 x 768	1280 x 768_60*	59.870	47.776	79.5
1280 x 800	WXGA_60*	59.810	49.702	83.500
	WXGA_75	74.934	62.795	106.500
	WXGA_85	84.880	71.554	122.500
	WXGA_120** (Reduce Blanking)	119.909	101.563	146.25
1280 x 1024	SXGA_60***	60.020	63.981	108.000
	SXGA_75	75.025	79.976	135.000
	SXGA_85	85.024	91.146	157.500
1280 x 960	1280 x 960_60***	60.000	60.000	108
	1280 x 960_85	85.002	85.938	148.500
1360 x 768	1360 x 768_60***	60.015	47.712	85.500
1440 x 900	WXGA+ 60***	59.887	55.935	106.500
1400 x 1050	SXGA+ 60***	59.978	65.317	121.750
1600 x 1200	UXGA	60.000	75.000	162.000
1680 x 1050	1680x1050_60	59.954	65.290	146.250
640 x 480@67Hz	MAC13	66.667	35.000	30.240
832 x 624@75Hz	MAC16	74.546	49.722	57.280
1024 x 768@75Hz	MAC19	75.020	60.241	80.000
1152 x 870@75Hz	MAC21	75.06	68.68	100.00

 \*Supported timing for non-3D and 3D signal with **Frame Sequential** and **Top-Bottom** format.

\*\*Supported timing for non-3D and 3D signal with **Frame Sequential** format.

\*\*\*Supported timing for non-3D and 3D signal with **Top-Bottom** format.

Timing	Resolution	Vertical Frequency (Hz)	Horizontal Frequency (kHz)	Pixel Frequency (MHz)	Remark
480i**	720 x 480	59.94	15.73	27	HDMI only
480p	720 x 480	59.94	31.47	27	HDMI only
576i	720 x 576	50	15.63	27	HDMI/DVI
576p	720 x 576	50	31.25	27	HDMI/DVI
720/50p	1280 x 720	50	37.5	74.25	HDMI/DVI
720/60p	1280 x 720	60	45.00	74.25	HDMI/DVI
1080/50i	1920 x 1080	50	28.13	74.25	HDMI/DVI
1080/60i	1920 x 1080	60	33.75	74.25	HDMI/DVI
1080/24P	1920 x 1080	24	27	74.25	HDMI/DVI
1080/25P	1920 x 1080	25	28.13	74.25	HDMI/DVI
1080/30P	1920 x 1080	30	33.75	74.25	HDMI/DVI
1080/50P	1920 x 1080	50	56.25	148.5	HDMI/DVI
1080/60P	1920 x 1080	60	67.5	148.5	HDMI/DVI

☞ Displaying a 1080i(1125i)@60Hz or 1080i(1125i)@50Hz signal may result in slight image vibration.

\*\*Supported timing for non-3D and 3D signal with **Frame Sequential** format.

## Supported timing for Component-YPbPr input

Timing	Resolution	Vertical Frequency (Hz)	Horizontal Frequency (kHz)	Pixel Frequency (MHz)
480i**	720 x 480	59.94	15.73	13.5
480p	720 x 480	59.94	31.47	27
576i	720 x 576	50	15.63	13.5
576p	720 x 576	50	31.25	27
720/50p	1280 x 720	50	37.5	74.25
720/60p	1280 x 720	60	45.00	74.25
1080/50i	1920 x 1080	50	28.13	74.25
1080/60i	1920 x 1080	60	33.75	74.25
1080/24P	1920 x 1080	24	27	74.25
1080/25P	1920 x 1080	25	28.13	74.25
1080/30P	1920 x 1080	30	33.75	74.25
1080/50P	1920 x 1080	50	56.25	148.5
1080/60P	1920 x 1080	60	67.5	148.5

☞ Displaying a 1080i(1125i)@60Hz or 1080i(1125i)@50Hz signal may result in slight image vibration.

\*\*Supported timing for non-3D and 3D signal with **Frame Sequential** format.

## Supported timing for Video and S-Video inputs

Video mode	Horizontal Frequency (kHz)	Vertical Frequency (Hz)	Color sub-carrier Frequency (MHz)
NTSC**	15.73	60	3.58
PAL	15.63	50	4.43
SECAM	15.63	50	4.25 or 4.41
PAL-M	15.73	60	3.58
PAL-N	15.63	50	3.58
PAL-60	15.73	60	4.43
NTSC4.43	15.73	60	4.43

☞ \*\*Supported timing for non-3D and 3D signal with **Frame Sequential** format.

# Warranty and Copyright information

## Limited warranty

BenQ warrants this product against any defects in material and workmanship, under normal usage and storage.

Proof of purchase date will be required with any warranty claim. In the event this product is found to be defective within the warranty period, BenQ's only obligation and your exclusive remedy shall be replacement of any defective parts (labor included). To obtain warranty service, immediately notify the dealer from which you purchased the product of any defects.

Important: The above warranty shall be void if the customer fails to operate the product in accordance with BenQ's written instructions, especially the ambient humidity must be in-between 10% and 90%, temperature in-between 0°C and 35°C, altitude lower than 4920 feet, and avoiding to operate the projector in a dusty environment. This warranty gives you specific legal rights, and you may have other rights which vary from country to country.

For other information, please visit [www.BenQ.com](http://www.BenQ.com).

## Copyright

Copyright 2011 by BenQ Corporation. All rights reserved. No part of this publication may be reproduced, transcribed, stored in a retrieval system or translated into any language or computer language, in any form or by any means, electronic, mechanical, magnetic, optical, chemical, manual or otherwise, without the prior written permission of BenQ Corporation.

## Disclaimer

BenQ Corporation makes no representations or warranties, either expressed or implied, with respect to the contents hereof and specifically disclaims any warranties, merchantability or fitness for any particular purpose. Further, BenQ Corporation reserves the right to revise this publication and to make changes from time to time in the contents hereof without obligation to notify any person of such revision or changes.

\*DLP, Digital Micromirror Device and DMD are trademarks of Texas Instruments. Others are copyrights of their respective companies or organizations.

## Patents

This BenQ projector is covered by the following patents:

U.S. patents 6,837,608; 7,181,318. TW patents 202690; I259932.

China patents ( 中国发明专利 ) ZL01143168.7; ZL200510051609.2

## Free Manuals Download Website

<http://myh66.com>

<http://usermanuals.us>

<http://www.somanuals.com>

<http://www.4manuals.cc>

<http://www.manual-lib.com>

<http://www.404manual.com>

<http://www.luxmanual.com>

<http://aubethermostatmanual.com>

Golf course search by state

<http://golfingnear.com>

Email search by domain

<http://emailbydomain.com>

Auto manuals search

<http://auto.somanuals.com>

TV manuals search

<http://tv.somanuals.com>