



# BILLY GOAT KV VACUUM

## Owner's Manual

KV600SP, KV650SPH, TKV650SPH

### Accessories

<p><b>ON BOARD VACUUM HOSE KIT</b></p>	<p><b>FELT DEBRIS BAG</b></p>	<p><b>NOZZLE WEAR GUARD KIT</b></p>	<p><b>CASTER KIT</b></p>	<p><b>SHREDDER KIT</b></p>	<p><b>KV LINER KIT</b></p>
<p>4"(102mm) x 7' (2.13m) For vacuuming in hard to reach areas.</p>	<p>For use in leaves and grass in dusty conditions.</p>	<p>For use in increasing the life of your nozzle by protecting it from damage</p>	<p>To allow for easy rolling and maneuverability on smooth surfaces.</p>	<p>Shreds leaves, reducing total volume.</p>	<p>Increases the life of the housing by protecting it from damage.</p>
<p><b>P/N 891125</b></p>	<p><b>P/N 891126</b></p>	<p><b>P/N 891127</b></p>	<p><b>P/N 891128</b></p>	<p><b>P/N 890209</b></p>	<p><b>P/N 891134</b></p>



**ABOUT THIS MANUAL**

**THANK YOU** for purchasing a BILLY GOAT® *KV Vacuum*. Your new machine has been carefully designed and manufactured to provide years of reliable and productive service. This manual provides complete operating and maintenance instructions that will help to maintain your machine in top running order. Read this manual carefully before assembling, operating, or servicing your equipment.

**CONTENTS**

SERIAL PLATE DATA AND SPECIFICATIONS _____	3
GENERAL SAFETY _____	4-5
SOUND AND VIBRATION _____	6
INSTRUCTION LABELS _____	7
PACKING CHECKLIST & ASSEMBLY _____	8
OPERATION _____	9-10
MAINTENANCE _____	11
TROUBLESHOOTING AND WARRANTY PROCEDURE _____	12
MAINTENANCE RECORD _____	13
ILLUSTRATED PARTS & PARTS LISTS _____	14-15



**SERIAL PLATE DATA**

Record the model number, serial number, date of purchase, and where purchased.

Purchase Date: \_\_\_\_\_

Purchased From: \_\_\_\_\_

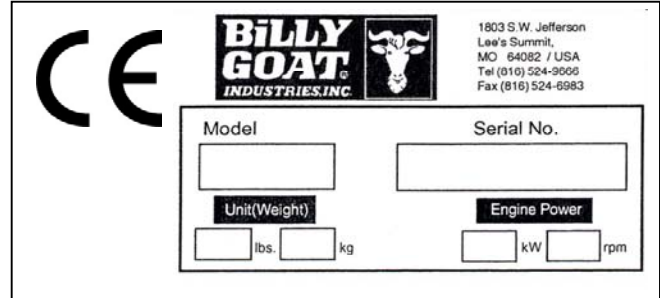

**Specifications**

	<b>KV600SP</b>	<b>KV650SPH</b>	<b>TKV650SPH</b>
Engine: HP	6.0 (4.47kW)	6.5 (4.85kW)	6.5 (4.85 kW)
Engine: Type	B&S Quantum	HONDA	HONDA
Engine: Model	112K020124E1	GSV190AN1L	GSV190AN1L
Engine: Fuel Capacity	1.5 qt. (1.4 L)	1.6 qt. (1.5 L)	1.6 qt. (1.5 L)
Engine: Oil Capacity	0.63 qt. (0.6 L)	0.58 qt (0.54L)	0.58 qt (0.54L)
Total Unit Weight:	#129 (58.5 kg)	#132 (58.9 kg)	141# (64 kg)
Overall Length	59" (1.5m)	59" (1.5m)	59" (1.5 m)
Overall Width	25.5" (.6 m)	25.5" (.6 m)	25.5" (.6 m)
Overall Height	42.75" (1.1m)	42.75" (1.1m)	42.75" (1.1 m)
Max. operating slope	20 <sup>0</sup>	20 <sup>0</sup>	20 <sup>0</sup>
Sound in accordance with 2000/14/EEC standards	109 dBa	109 dBa	112 dBa
Sound at operator's ear	88 dBa	89 dBa	91 dBa
Vibration at operator position	0.71 g (6.96m/s <sup>2</sup> )	0.32 g (3.16m/s <sup>2</sup> )	0.43 g (4.25m/s <sup>2</sup> )

**GENERAL SAFETY INSTRUCTIONS and SYMBOLS**

The safety symbols shown below are used throughout this manual. You should become familiar with them before assembling, operating, or servicing this equipment.



**WARNING:** This symbol indicates important information that will prevent injury to yourself or others.



This symbol indicates ear protection is recommended when operating this equipment.



This symbol indicates eye protection is recommended when operating this equipment.



This symbol indicates gloves should be worn when servicing this equipment.



This symbol indicates that this manual and the engine manufacturer's manual should be read carefully before assembling, operation, or servicing this equipment.



**CAUTION:** This symbol indicates important information that will prevent damage to your BILLY GOAT® KV Vacuum.



This symbol indicates the engine oil level should be checked before operating this equipment.

Read and make sure you thoroughly understand the following safety precautions before assembling, operating or servicing this equipment:



**READ** this manual and the engine manufacturer's manual carefully before assembling, operating, or servicing this equipment.



**EAR PROTECTION** is recommended when operating this equipment.



**EYE PROTECTION** is recommended when operating this equipment.



**BREATHING PROTECTION** is recommended when operating this equipment.



**WARNING:** **EXHAUST** from this product contains chemicals known to the State of California to cause cancer, birth defects or other reproductive harm.

**DO NOT** operate this equipment on any unimproved forested, brushy, or grass covered land unless a spark arrester is installed on the muffler as required by Section 4442 of the California Public Resources Code. The arrester must be maintained in good working order. Other states may have similar laws. Federal laws apply on federal lands.



















**DO NOT** run engine in an enclosed area. Exhaust gases contain carbon monoxide, an odorless and possibly fatal poison.



## KVSP/TKVSP Owner's Manual



**WARNING:**

-  **DO NOT** run this equipment indoors or in any poorly ventilated area. Refueling outdoors is recommended.
  -  **DO NOT** refuel this equipment while the engine is running. Allow engine to cool for at least two minutes before refueling.
  -  **DO NOT** store gasoline near an open flame.
  -  **DO NOT** remove gas cap while engine is running.
  -  **DO NOT** start or operate engine if strong odor of gasoline is present.
  -  **DO NOT** start or operate engine if gasoline is spilled. Move equipment away from spill until gasoline has completely evaporated.
  -  **DO NOT** smoke while filling the fuel tank.
  -  **DO NOT** check for spark with spark plug or spark plug wire removed. Use an approved spark tester.
  -  **DO NOT** operate engine without a muffler. Inspect muffler periodically and replace if necessary. If equipped with muffler deflector, inspect deflector periodically and replace if necessary.
  -  **DO NOT** operate engine with grass, leaves or other combustible material near the muffler.
  -  **DO NOT** touch muffler, cylinder, or cooling fins when hot. Contact with hot surfaces may cause severe burns.
  -  **DO NOT** leave equipment unattended while in operation.
  -  **DO NOT** park equipment on a steep grade or slope.
  -  **DO NOT** operate equipment with bystanders in or near the work area.
  -  **DO NOT** allow children to operate this equipment.
  -  **DO NOT** operate equipment with guards removed.
  -  **DO NOT** operate equipment near hot or burning debris or any toxic or explosive materials.
  -  **DO NOT** operate equipment on slopes greater than specified in Specifications section of this manual.
  -  **DO NOT** place hands or feet underneath unit, or near any moving parts.
- ALWAYS** remove spark plug wire when servicing equipment to prevent accidental starting.
- ALWAYS** check fuel lines and fittings frequently for cracks or leaks. Replace if necessary.
- ALWAYS** keep hands and feet away from moving or rotating parts.
- ALWAYS** store fuel in approved safety containers.



**WARNING: Important**

Remove all rocks, wire, string, plastic, etc. that can present a hazard during work prior to starting.



**DO** identify and mark all fixed objects to be avoided during work such as sprinkler heads, water valves, buried cables, or clothes line anchors, etc.



**SOUND**



SOUND LEVEL 92 dB(a) at Operator Position

Sound tests were conducted in accordance with 2000/14/EEC, and were performed on 7-25-07 under the conditions listed below.

**⚠** Sound power level listed is the highest value for any model covered in this manual. Please refer to serial plate on the unit for the sound power level for your model.

General Conditions:	Sunny
Temperature:	88°F (31.1°C)
Wind Speed:	2 mph (3.8 kmh)
Wind Direction:	South South East
Humidity:	44%
Barometric Pressure:	30.07"Hg (764 mm Hg)

**VIBRATION DATA**

VIBRATION LEVEL 0.34g (3.29m/s<sup>2</sup>)

Vibration levels at the operator's handles were measured in the vertical, lateral and longitudinal directions using calibrated vibration test equipment. Tests were performed on 12-19-2007 under the conditions listed below.

General Conditions:	Sunny
Temperature:	50°F (10°C)
Wind Speed:	4 mph (6.4kph)
Wind Direction:	South Southeast
Humidity:	68%
Barometric Pressure:	30 Hg (101.6kpa)

**INTENDED USE**

**INTENDED USE:** This machine is designed for vacuuming leaves, grass clippings and other types of organic litter.

Debris mixed with cans, bottles and small amounts of sand can be vacuumed; however, it is not this machine's primary purpose. Vacuuming cans, bottles and sand will affect the longevity of your machine.

Do not operate if excessive vibration occurs. If excessive vibration occurs, shut engine off immediately and check for damaged or worn impeller, loose impeller bolt, loose impeller key, loose engine or lodged foreign objects.

Note: See parts list for proper impeller bolt torque specifications. (See trouble shooting section on page 12).

**INSTRUCTION LABELS**

The labels shown below were installed on your BILLY GOAT® KV Vacuum. If any labels are damaged or missing, replace them before operating this equipment. Item numbers from the Illustrated Parts List and part numbers are provided for convenience in ordering replacement labels. The correct position for each label may be determined by referring to the Figure and Item numbers shown.



**LABEL DANGER KEEP HANDS AND FEET AWAY**  
ITEM #18 P/N 400424



**LABEL EAR EYE BREATHING ITEM #20**  
P/N 890254



**DANGER FLYING DEBRIS**  
ITEM # 19 P/N 810736



**LABEL READ MANUAL**  
ITEM #17 P/N 890301

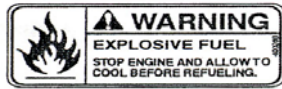

**LABEL EXPLOSIVE FUEL**  
ITEM # 16 P/N 400268



**CHIPPER WARNING LABEL**  
ITEM #82 P/N 890152 (TKV ONLY)



**LABEL DANGER GUARD**  
ITEM #39 P/N 900327

**BAG ENCLOSURE INSTRUCTION:**  
NOTE: IT IS IDEAL TO DO THIS PROCEDURE WITH THE BAG ON THE GROUND WITH BOTTOM PAD FACING UP.

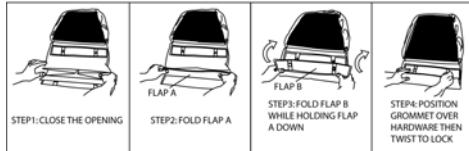

**BAG FOLDING INSTRUCTIONS**  
LOCATED ON BAG

**ENGINE LABELS**

**HONDA**

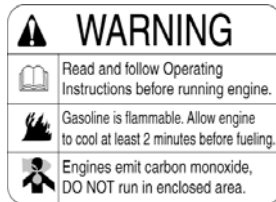
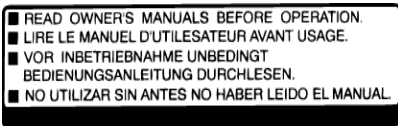

**BRIGGS & STRATTON**

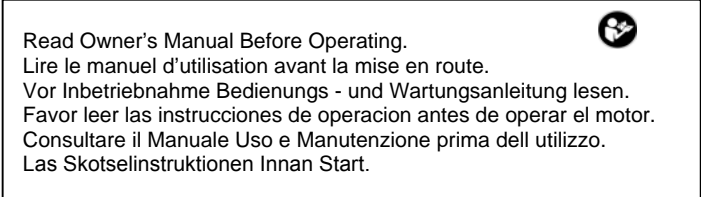

**ENGINE and Transmission CONTROLS**



**Honda Throttle Control**

Part No 891058



**Briggs Throttle Control**

7

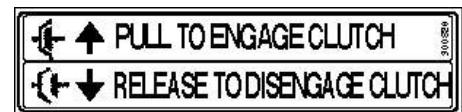

**Bail Drive Engage/Disengage label**

Form No F042508A



## PACKING CHECKLIST

Your Billy Goat KV Vacuum is shipped from the factory in one carton, completely assembled except for the upper handle, debris bag, and bag quick disconnect.



**READ** all safety instructions before assembling unit.

**TAKE CAUTION** when removing the unit from the box the Handle Assembly is attached by cables and folded over



**PUT OIL IN ENGINE BEFORE STARTING**

## PARTS BAG & LITERATURE ASSY

Warranty card P/N- 400972, Owner's Manual P/N-891058, Declaration of Conformity P/N-891057.

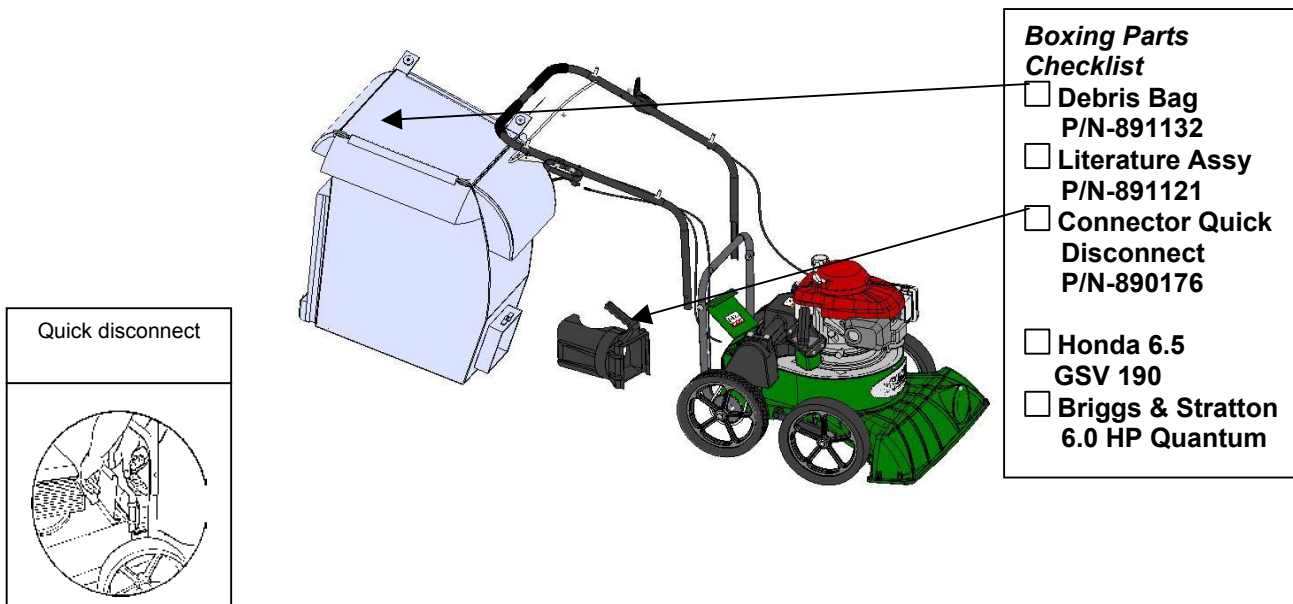

Fig. 2

## ASSEMBLY

1. **ASSEMBLE** Lift upper handle (item 11), remove items 49, 50, & 51 from lower handle (item 10). Attach and secure upper handle as shown using same hardware.
2. **UNFOLD** the debris bag (item 21) and fasten bag neck to bag quick disconnect (item 12). Attach firmly to housing exhaust (item 1) see fig. 2.
3. **ATTACH** bag to four posts (item 13), preassembled to upper handle.
4. **CONNECT** spark plug wire.





## OPERATION

 Like all mechanical tools, reasonable care must be used when operating machine. **Inspect machine work area and machine before operating. Make sure that all operators of this equipment are trained in general machine use and safety.**

 **PUT OIL IN ENGINE BEFORE STARTING**

### STARTING

 **ENGINE:** See engine manufacturer's instructions for type and amount of oil and gasoline used. Engine must be level when checking and filling oil and gasoline.

**ENGINE SPEED:** Controlled by throttle lever on the engine. Under normal conditions, operate at minimum throttle to accomplish your current cleaning task.

**FUEL VALVE:** Move fuel valve to "ON" position (when provided on engine).

**CHOKE:** Briggs-Located on engine and must be controlled manually.  
Honda-Place remote throttle in choke position

**PRIMER:** Push primer per engine instructions (B&S only).

**THROTTLE:** Move throttle to fast/choke position. Located on handle.

**TRANSMISSION:** Engaged by pulling the clutch bail towards handle.

### **IF YOUR UNIT FAILS TO START:**

See Troubleshooting on page 12.

### **HANDLING & TRANSPORTING:**

 This unit requires two people to lift it. Lift holding the lower handle and front wheels. Secure the machine in place during transport. See page 3 for weight specifications

 Never lift the machine while the engine is running.

### **STORAGE**

 Never store engine indoors or in enclosed poorly ventilated areas with fuel in tank, where fuel fumes may reach an open flame, spark or pilot light, as on a furnace, water heater, clothes dryer or other gas appliance.

**If engine is to be unused for 30 days or more, prepare as follows:**

 Remove all gasoline from carburetor and fuel tank to prevent gum deposits from forming on these parts and causing possible malfunction of engine. Drain fuel outdoors, into an approved container, away from open flame. Be sure engine is cool. Do not smoke. Run engine until fuel tank is empty and engine runs out of gasoline.

**OPERATION**

**VACUUMING OPERATION**

**VACUUM NOZZLE HEIGHT ADJUSTMENT:** is raised and lowered by pushing slightly downward on handle to reduce tension on the adjuster, and then pulling height adjust trigger on the handle (item 23) up at right rear of machine. Then select the desired height that fits the task.

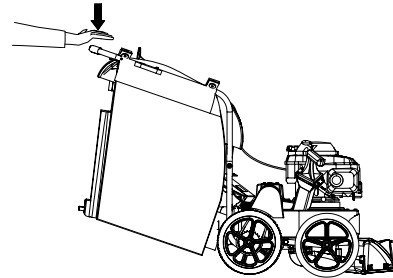

**FOR MAXIMUM PICKUP:** Adjust nozzle close to debris, but without blocking airflow into the nozzle. *NOTE:* Never bury nozzle into debris.

**CLEARING A CLOGGED NOZZLE & EXHAUST:** Turn engine off and wait for impeller to stop completely and disconnect spark plug wire. Wearing durable gloves, remove clog. **Danger**, the clog may contain sharp materials. Reconnect spark plug wire.



**BAG ENCLOSURE INSTRUCTION:**

*NOTE:* IT IS IDEAL TO DO THIS PROCEDURE WITH THE BAG ON THE GROUND WITH BOTTOM PAD FACING UP.

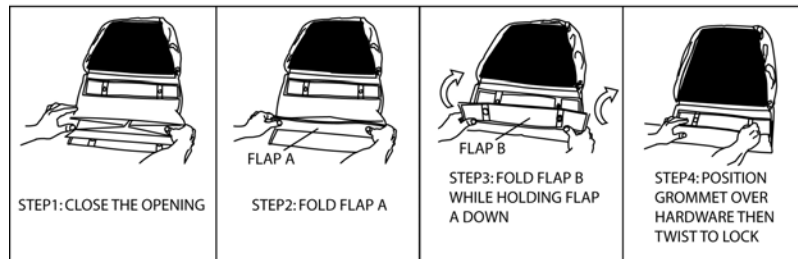

**DEBRIS BAG**

**Debris bags are normal replaceable wear items.**

*Note:* Frequently empty debris to prevent bag overloading with more weight than you can lift.

An optional felt bag is available for use where debris will be vacuumed in dusty conditions (see **Optional Accessories shown on page 1**).

**DO NOT** place bag on or near hot surface, such as engine. Be sure engine has come to a complete stop before removing or emptying bag.

**This vacuum is designed for picking up trash, organic material and other similar debris** (see Safety Warnings page 4-5).

However, many vacuums are used where dust is mixed with trash. Your unit can intermittently vacuum in dusty areas. Dust is the greatest cause of lost vacuum performance. However, following these rules will help maintain your machine's ability to vacuum in dusty conditions:

- Run machine at idle to quarter throttle.
- The debris bag must be cleaned more frequently. A vacuum with a clean, pillow soft bag will have good pickup performance. One with a dirty, tight bag will have poor pickup performance. If dirty, empty debris and vigorously shake bag free of dust.
- Pressure-wash debris bag if normal cleaning does not fully clean bag. Bag should be thoroughly dry before use.

**NOTE:** Having one or more spare debris bags is a good way to reduce down time while dirty bags are being cleaned.

**DO NOT** leave debris in bag while in storage.



### **COMPOST**

Vacuumed leaves, grass and other organic material from your own yard can be emptied into a pile or composter to provide enriched soil for later use as fertilizer in gardens and flower beds

**NOTE:** Allow green chips to dry before spreading around living plants.

### **MULCH**

Wood chips made from branches in your own yard make excellent mulch. A thick blanket of wood chips around plants and flowers to keeps weeds out and moisture in.

### **CHIPPER OPERATION (TKV only)**

Your **TKV** chipper is designed to process tree branches and limbs up to 2" (50.8mm) diameter.

Several small branches can be grouped together and fed together into the chipper (see figure right).

When feeding forked branches, squeeze forks together and feed into chipper entrance (DO NOT overload). If forks are too large, use a pair of loppers to trim forks down to size. A lopper storage bracket is provided on every unit (loppers are not included)

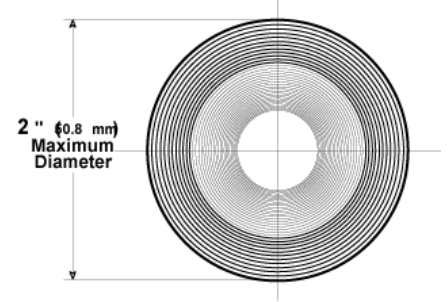

### **Clearing a clogged chipper (TKV only)**

**Under normal circumstances, allow time for machine to clear all wood from chipper hopper before stopping engine. Otherwise, remaining pieces of wood will jam inside of chipper when engine stops. (See Tamper below).**

Disconnect spark plug wire.

 Remove debris bag quick disconnect from debris outlet on machine. Wearing durable gloves, access impeller through debris outlet on fan housing and rotate impeller counter clock wise to dislodge and remove jam and remove debris from hopper with tongs or equivalent. Reconnect debris bag quick disconnect to machine. Reconnect spark plug wire.

### **TAMPER (TKV only)**

Before turning machine off, use the Tamper to slowly push remaining pieces of wood through the chipper. This can prevent any remaining wood from jamming in the chipper when machine is turned off.

Do not leave tamper on the ground, store tamper in the chipper hopper.





**MAINTENANCE**

**PERIODIC MAINTENANCE**

Periodic maintenance should be performed at the following intervals:

Maintenance Operation	Every Use (daily)	Every 5 hrs (daily)	Every 25 Hours
Inspect for loose, worn or damaged parts.		•	
Clean Debris bag	•		
Check bag strap tightness	•		
Engine (See Engine Manual)			
Check for excessive vibration		•	

**IMPELLER REMOVAL**

1. Wait for engine to cool and disconnect spark plug.
2. Drain fuel and oil from the engine.
3. Remove bag, quick release and upper handle. Do not kink, stretch, or break control cables, control housings, or end fittings while removing handles.
4. Remove the transmission cover, idler pulley, transmission and the belt from the transmission.
5. Remove the transmission plate and the housing top plate by removing bolts around outside of housing.
6. Leaving engine fastened to top plate; turn it upside down so the impeller is on top.
7. Remove impeller bolt and lock washer.
8. Lift impeller upward. If impeller slides freely, proceed to (step 10).
9. If the impeller does not loosen, obtain a 3/4-16x3" (Billy Goat part #440192) or longer bolt. Thread bolt by hand into nut until bolt rests against the shaft. Tighten the bolt slowly, which will pull the impeller away from the shaft, remove impeller from shaft. *Using a penetrating oil can help loosen a stuck impeller.*
10. Using a new impeller bolt and lockwasher, reinstall new impeller in reverse order.
11. Tighten impeller bolt. Torque impeller bolt to 33-38 Ft. Lbs. (44-51 N.m) (see item 45 on page 15).
12. Reinstall engine onto housing in reverse order of removal make sure the belt is inside the two fingers on the belt plate and that the belt is on the transmission pulley before securing the transmission.
13. Gas and oil.
14. Reconnect spark plug wire.

**DRIVE CHAIN REPLACEMENT AND ALIGNMENT**

1. Wait for engine to cool and disconnect spark plug.
2. To replace a chain, first prop up the rear of the machine with small blocks to get the rear wheels off of the ground.
3. Remove the transmission cover, and the belt from the transmission.
4. Remove the bolts on both sides of the transmission holding the flange bearings; this should give enough slack to slip the chain off.
4. Replace the old chain with a new one.
5. Once the chain is on, put the bolts back into the flange bearings and tighten.
6. Finally, make sure the wheels rotate freely. If not, loosen the bearings and shift them to get the chain running straight up and down.
7. Reassemble the transmission components removed in steps 1-3 in reverse order.

**BELT TENSION ADJUSTMENT****DO NOT ADJUST WHILE THE MACHINE IS RUNNING!**

1. Wait for engine to cool and disconnect spark plug.
2. Remove the transmission cover
3. Using two ½" wrenches loosen the two nuts on the cable that connects to the idler arm.
4. The setting of the tension on the belt is controlled by the distance on the threads of the cable. To loosen tension, move the position towards the end of the threads and in the opposite direction to tighten.
5. Check the travel of the idler arm by engaging the bail, which the drive should start to engage when the bail is 2 ½ inches away from the handle. The spring, at a relaxed state should be 1.5 inches long on the coil, and when the bail is in contact with the handle it should be 1.75 inches long. If the belt is too tight it can cause premature failure and if it is too loose it can come off of the pulley.
6. When satisfied with the position, place the transmission cover back into place and secure. Then run the machine to make sure the transmission is engaging properly. If the drive will not engage or will not disengage repeat the previous steps.

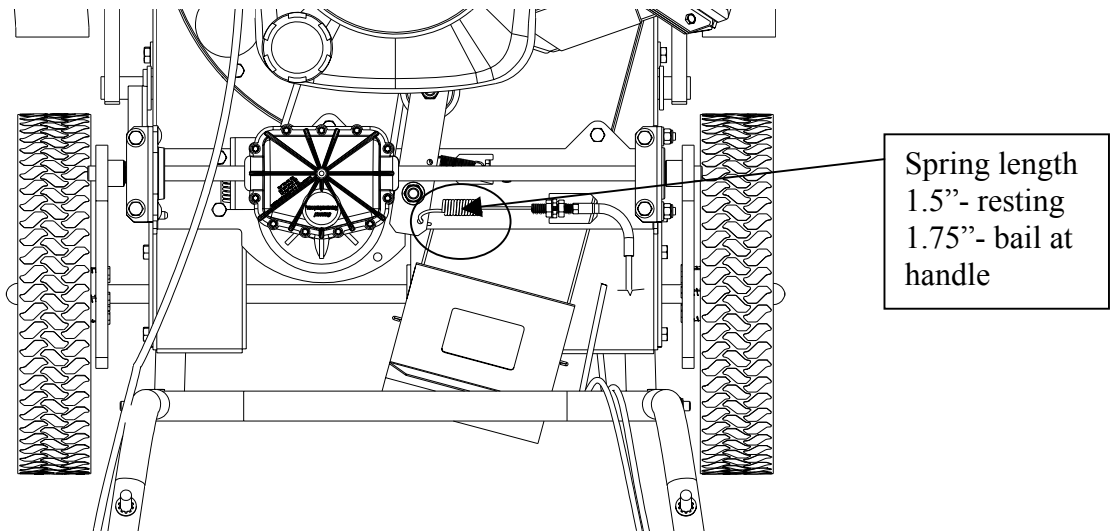
**BELT REPLACEMENT**

1. Wait for engine to cool and disconnect spark plug.
2. Drain fuel and oil from the engine.
3. Remove bag, quick release and upper handle. Do not kink, stretch, or break control cables, control housings, or end fittings while removing handles.
4. Remove the transmission cover, idler pulley, transmission and the belt from the transmission.
5. Remove the transmission plate and the housing top plate by removing bolts around outside of housing.
6. Leaving engine fastened to top plate, turn it upside down so the impeller is on top.
7. Remove impeller bolt and lock washer.
8. Lift impeller upward. If impeller slides freely, proceed to (step 10).
9. If the impeller does not loosen, obtain a 3/4-16x3" (Billy Goat part #440192) or longer bolt. Thread bolt by hand into nut until bolt rests against the shaft. Tighten the bolt slowly, which will pull the impeller away from the shaft, remove impeller from shaft. *Using a penetrating oil can help loosen a stuck impeller.*
10. Place the new belt on the shaft.
11. Using a new impeller bolt and lockwasher, reinstall new impeller in reverse order.
12. Tighten impeller bolt. Torque impeller bolt to 33-40 Ft. Lbs. (44-54 N.m) (see item 45 on page 15).
13. Make sure the belt is in the groove on the impeller and feed it through the hole in the top plate.
14. Reinstall engine onto housing in reverse order of removal make sure the belt is inside the two fingers on the belt plate and that the belt is on the transmission pulley before securing the transmission.
15. Gas and oil.
16. Reconnect spark plug wire.

**CHIPPER BLADE REMOVAL AND SHARPENING (TKV ONLY)**

Chipper blades are normal replaceable wear items.

**⚠ DANGER** Chipper blade is sharp. Replace any damaged blade.

*Depending on the type and amount of wood being chipped, the chipper blade will eventually get dull, losing its cutting ability. Evidence of a dull blade is a noticeably reduced chipping ability or a rough cut on end of branch.*

**Note:** The chipper blade gap is factory set and should be checked each time impeller is removed from engine crankshaft and reset if required. If reassembly requires a different quantity of shim washers, Billy Goat® shim washer must be used.

1. Follow the steps 1-6 on the impeller removal instructions.
2. Using a 3/16" Allen wrench and 1/2" open end wrench, remove chipper blade from impeller.
3. Sharpen blade by lightly grinding the cutting edge of the blade at **40 degrees** (see figure below). It is not necessary to remove all nicks from the cutting edge. **CAUTION:** Be careful to avoid heat buildup in the blade during sharpening. This will reduce its heat-treated hardness properties and will reduce blade life. Evidence of too much heat build-up is a change of color along sharpened edge.
4. The same chipper blade can be sharpened several times. However, blade replacement is required when blade no longer overhangs the chip relief hole in impeller back plate or if increased vibration occurs (see fig below).
5. Chipper blade installation is in reverse order of removal.

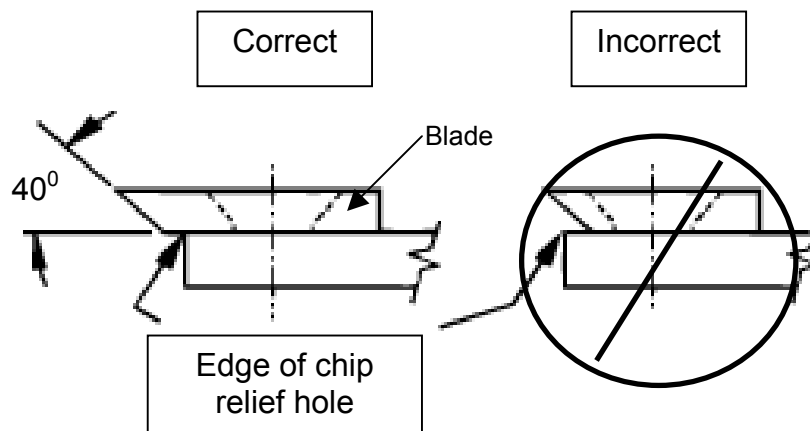





**Troubleshooting**

Problem	Possible Cause	Solution
Abnormal vibration.	· Loose or out of balance impeller or loose engine	· Check impeller and replace if required. Check engine
Will not vacuum or has poor vacuum performance	· dirty debris bag. Hose kit cap missing. · Clogged nozzle or exhaust. Excessive quantity of debris. · Improper nozzle height	· Clean debris bag. Shake bag clean or wash. Check for hose kit cap. Unclog nozzle or exhaust. Allow air to feed with debris · Adjust nozzle height so that it is closer to the debris
Engine will not start.	· Throttle in off position. Engine not in full choke position. Out of gasoline. Bad or old gasoline. Sparkplug wire disconnected. Dirty air cleaner	· Check stop switches, throttle, choke position and gasoline. Connect spark plug wire. Clean or replace air filter. Or contact a qualified service person.
Engine is locked, will not pull over.	· Debris locked in impeller. Engine problem.	· See page 5. Contact a engine service dealer for engine problems
Nozzle scrapes ground in lowest height setting.	Nozzle height out of adjustment	Adjust nozzle height (See Nozzle height fine adjustment for hard surfaces on page 5)
No self-propelling	· Drive bail not engaged · Drive belt worn or broken · Drive clutch cable out of adjustment or broken. · Drive chain off the sprocket.	· Engage the drive bail. · Check the drive belt. · Check the drive clutch cable (see page 12). · Check the drive chain (see page 12).
Self propelled drive will not release	· Improper drive clutch cable adjustment or cable is kinked.	· Check the drive clutch cable (see page 13).
Noisy or broken chain	· No chain lubrication. · Chain misalignment or tension.	· Lubricate chain. · Check the drive chain (see page 12).
Unit does not free-wheel backwards	· None	· Push the unit slightly forward then the unit will free-wheel
Too much dust coming from bag.	· Vacuuming very dry, brittle or small debris	· Switch to felt bag (see page 1 accessories)

When servicing engine refer to specific manufacturers engine owner's manual. Engine warranty is covered by the specific engine manufacturer. If your engine requires warranty or other repair work contact your local servicing engine dealer. When contacting a dealer for service it is a good idea to have your engine model number available for reference (See table page 3). If you cannot locate a servicing dealer in your area you can contact the manufacturers national service organization. To reach:

**American Honda:** 800-426-7701  
**Briggs & Stratton:** 800-233-3723

**WARRANTY CLAIM PROCEDURE**

Should a BILLY GOAT<sup>®</sup> machine fail due to a defect in material and/or workmanship, the owner should make a warranty claim as follows:

- The machine must be taken to the dealer from whom it was purchased or to an authorized Servicing BILLY GOAT Dealer.
- The owner must present the remaining half of the Warranty Registration Card, or, if this is not available, the invoice or receipt.
- The Warranty Claim will be completed by the authorized BILLY GOAT Dealer and submitted to their respective BILLY GOAT Distributor for their territory Attention: Service Manager. Any parts replaced under warranty must be tagged and retained for 90 days. The model number and serial number of the unit must be stated in the Warranty Claim.
- The distributor service manager will sign off on the claim and submit it to BILLY GOAT for consideration.
- The Technical Service Department at BILLY GOAT will study the claim and may request parts to be returned for examination. BILLY GOAT will notify their conclusions to the distributor service manager from whom the claim was received.
- The decision by the Technical Service Department at BILLY GOAT to approve or reject a Warranty Claim is final and binding.

For online product registration go to [www.billygoat.com](http://www.billygoat.com)



**PARTS DRAWING KVSP/TKVSP**

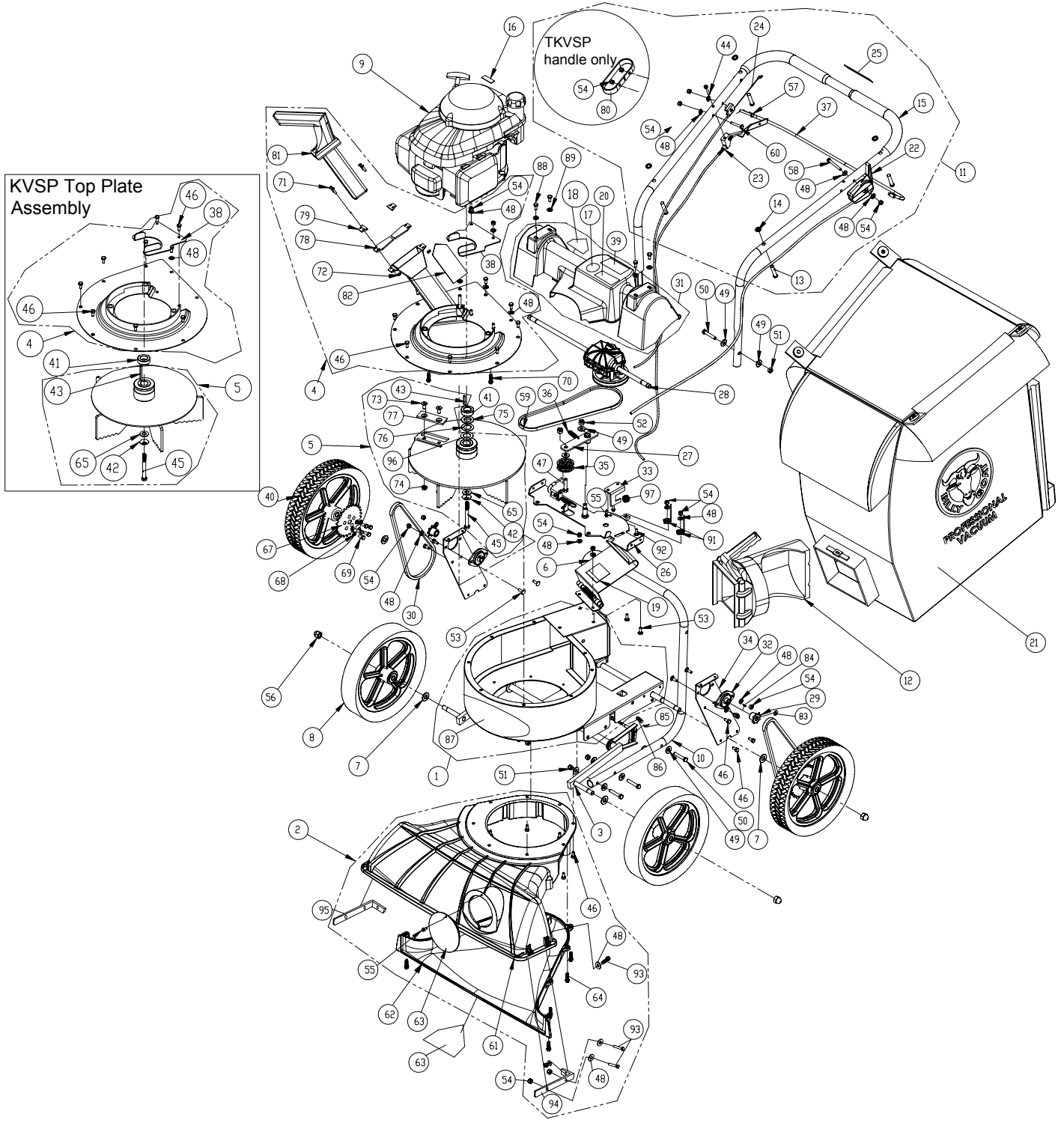



# KVSP/TKVSP Owner's Manual

## PARTS LIST KVSP/TKVSP

\* Denotes standard hardware item that may be purchased locally.

ITEM NO.	Description	KV600SP PART	QTY	KV650SPH PART	QTY	TKV650SPH PART	QTY
1	MAIN FRAME HOUSING KV	891100-S	1	891100-S	1	891100-S	1
2	NOZZLE ASSEMBLY TKV	891110-S	1	891110-S	1	891110-S	1
3	AXLE FRONT WA KV	891103	1	891103	1	891103	1
4	PLATE TOP WA KVSP	891101-S	1	891101-S	1	891101-S	1
5	IMPELLER SERRATED 14.25 WA KVSP	891104-S	1	891104-S	1	891104-S	1
6	DOOR EXHAUST ASSY RAW	890148-01	1	890148-01	1	890148-01	1
7	WASHER 1/2" SAE Z/P	8172011	4	8172011	4	8172011	4
8	WHEEL ASSY 12" X 2.5" TREAD	900509	4	900509	2	900509	2
9	ENGINE 6.5 HP HONDA GSV190AN1L	-	-	840069	1	840069	1
	ENGINE & BRIGGSAND STRATTON	890622	1	-	-	-	-
10	LOWER HANDLE KV	891050	1	891050	1	891050	1
11	HANDLE UPPER KVSP	891054-S	1	891054-S	1	891054-S	1
12	QUICK DISCONNECT	890176	1	890176	1	890176	1
13	PIN CLEVIS 3/8" X 2.125" LONG	520120	4	520120	4	520120	4
14	RETAINER	360279	4	360279	4	360279	4
15	GRIP HANDLE 1" X 9.5" LG	430342	2	430342	2	430342	2
16	LABEL HOT ENGINE	400268	1	400268	1	400268	1
17	LABEL READ	890301	1	890301	1	890301	1
18	LABEL WARNING DANGER	400424	2	400424	2	400424	2
19	LABEL DANGER FLYING DEBRIS	810736	1	810736	1	810736	1
20	LABEL EAR EYE BREATHING	890254	1	890254	1	890254	1
21	BAG DEBRIS NO ZIPPER KV	891132	1	891132	1	891132	1
22	CABLE THROTTLE ASSY 42" W/CHOKE	891036	1	891027	1	891027	1
23	CABLE HGT ADJ TRIGGER KV	891001	1	891001	1	891001	1
24	CABLE CLUTCH DRIVE ASSY 40" KVSP	891032	1	891032	1	891032	1
25	LABEL CLUTCH VQ	900328	1	900328	1	900328	1
26	BRACKET TRANS MOUNT WA KV	891106	1	891106	1	891106	1
27	ARM IDLER DRIVE WA KV	891105	1	891105	1	891105	1
28	TRANS SINGLE SPEED W/DIFF	891020	1	891020	1	891020	1
29	SPROCKET 8 TOOTH #43 OR #65	891022	2	891022	2	891022	2
30	CHAIN #43 X 58 PITCHES	891023	2	891023	2	891023	2
31	GUARD DRIVE KV	891004-S	1	891004-S	1	891004-S	1
32	BEARING 1/2" PRESSED STEEL HOUSING	891025	2	891025	2	891025	2
33	BRACKET TRANS FIX KV	891012	1	891012	1	891012	1
34	PLATE CHAIN REINFORCE KV	891014	2	891014	2	891014	2
35	PULLEY IDLER 2" OD X 3/8" ID	840087	1	840087	1	840087	1
36	SPRING TENSION	800242	1	800242	1	800242	1
37	BAIL CLUTCH WA KVSP	891102	1	891102	1	891102	1
38	BRACKET IDLER BELT FINGER KV	891028	1	891028	1	891028	1
39	LABEL DANGER GUARD	900327	1	900327	1	900327	1
40	WHEEL ASSY SP 26T SPROCKET	890242	2	890242	2	890242	2
41	SPACER 1.50OD X .890ID X .5 THK	-	-	840083	1	840083	1
42	WASHER LOCK 3/8 TWISTED TOOTH	400502	1	400502	1	400502	1
43	SQ KEY 2.125 X .187	9201087	1	9201087	1	9201087	1
44	SCREW MACHINE #10-16 X 1 1/2" HWF ZP	891042	1	891042	1	891042	1
45	SCREWCAP 3/8-24 X 3 1/2 GR. 8 W/PATCH	440151	1	440151	1	440151	1
46	SCREWCAP 1/4 - 20 X 5/8 HWH	890359	28	890359	28	890359	28
47	BOLT IDLER 3/8-16 X 1 1/2	800888	1	800888	1	800888	1
48	WASHER 1/4" SAE ZP	8172007	17	8172007	17	8172007	17
49	WASHER 5/16 FLATWASHER Z/P	8171003	17	8171003	17	8171003	17
50	SCREWCAP 5/16-18 X 1.75 ZP	8041031	8	8041031	8	8041031	8
51	NUT LOCK 5/16-18	8160002	8	8160002	8	8160002	8
52	NYLON INSERT LOCKNUT, 3/8-16 UNC	8160003	2	8160003	2	8160003	2
53	SCREWCAP 1/4-20 X 3/4"	8041004	6	8041004	6	8041004	6
54	NYLON INSERT LOCKNUT, 1/4-20 UNC	8160001	15	8160001	15	8160001	15
55	SCREWCAP #10-14 X 3/4" HWH ZP	891043	3	891043	3	891043	3
56	1/2-13 CAP NUT NP W/PATCH	890530	4	890530	4	890530	4
57	SCREWCAP 1/4-20 X 1 3/4 HCS ZP	8041009	1	8041009	1	8041009	1
58	SCREWCAP 1/4-20X2.25X0.75-N	8041011	1	8041011	1	8041011	1
59	BELT 3L310	891026	1	891026	1	891026	1
60	SCREWCAP 1/4" - 20 X 1 1/2" HCS ZP	-	-	-	-	8041008	1
61	NOZZLE TOP HALF KV	891002	1	891002	1	891002	1
62	NOZZLE BOTTOM HALF KV	891003	1	891003	1	891003	1
63	PLUG HOUSING KD LB	900146-01	1	900146-01	1	900146-01	1
64	SCREW PLASTIC 1/4-20 X 1	891039	8	891039	8	891039	8
65	WASHER 1.5 OD X .453 ID X .25 THK	440153	1	440153	1	440153	1
66	SCREW SELF TAP 10-24 X 1/2	8123086	1	8123086	1	8123086	1
67	SPROCKET 65A26 26 TOOTH	890238	1	890238	1	890238	1
68	WASHER LOCK 1/4" EXTERNAL TOOTH	8181007	5	8181007	5	8181007	5
69	SCREW SELF TAP 1/4 X 0.75	900505	5	900505	5	900505	5
70	SCREW TAPTITE 3/8 X 1 1/2	900564	3	900564	3	900564	3
71	SCREWCAP #10-24 X 5/8"	-	-	-	-	8059135	4
72	NYLON INSERT LOCKNUT 10-32 UNF ZINC	-	-	-	-	8164005	4
73	SCREW SOCKET HD 5/16-18 X 3/4 GR. 8	-	-	-	-	890103	2
74	NUT KEPS 5/16-18	-	-	-	-	890104	2
75	WASHER SHIM 0.875 ID X 0.060	-	-	-	-	891040	1
76	WASHER SHIM 0.875 ID X 0.020	-	-	-	-	891041	0-3
77	BLADE CHIPPER KD501	-	-	-	-	890101	1
78	GUARD FLAPPER	-	-	-	-	890119	2
79	PLATE FLAPPER ENTRANCE	-	-	-	-	890127	2
80	BRACKET LOPPER LOOP	-	-	-	-	890167	1
81	TAMPER CHIPPER	-	-	-	-	890229	1
82	LABEL DANGER CHIPPER	-	-	-	-	890152	1
83	CLIP 1/2"	350146	4	350146	4	350146	4
84	WOODRUFF KEY 1/8 X 1/2	510180	2	510180	2	510180	2
85	HAIR PIN COTTER 1/4	900471	1	900471	1	900471	1
86	SPRING COMPRESSION KD HGT	900136	1	900136	1	900136	1
87	LABEL DECAL KV/TKV	891046	1	891046	1	891047	1
88	SCREW SM 1/4 X 3/4 DRILL PT	510208	4	510208	4	510208	4
89	WASHER 1/4" SAE BLACK OXIDE	510193	4	510193	4	510193	4
91	BELT FINGER GUIDE	891063	2	891063	2	891063	2
92	CARRIAGE BOLT 1/4"-20 X 3/4"	8024021	2	8024021	2	8024021	2
93	SCREWCAP 1/4-20 X 1" HCS ZP	8041006	6	8041006	6	8041006	6
94	KV REINFORCEMENT NOZZLE BRACKET LFT	891062	1	891062	1	891062	1
95	KV REINFORCEMENT NOZZLE BRACKET RT	891064	1	891064	1	891064	1
96	WASHER SHIM 0.060	-	-	-	-	891065	1
97	SPRING LEVER GZ	610429	1	610429	1	610429	1

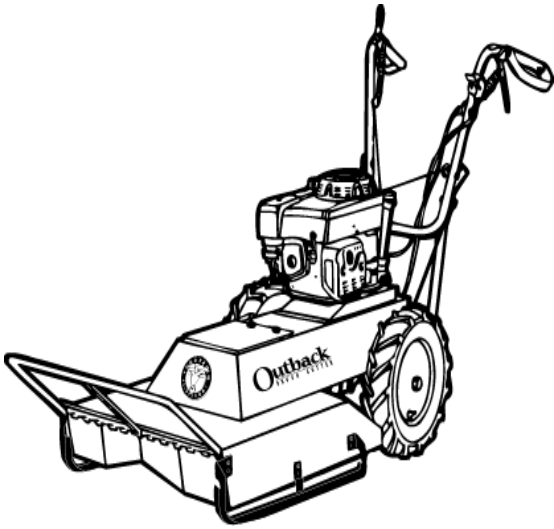
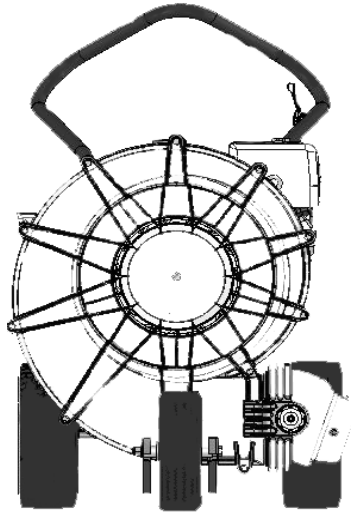
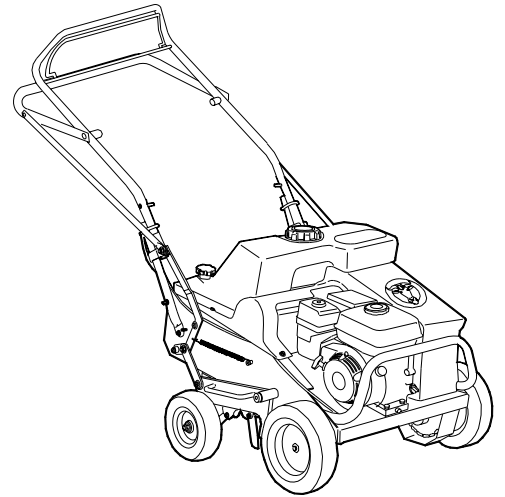

**BRUSH CUTTER****FORCE BLOWER****AERATOR**

If you liked this product please feel free to view our full line of quality lawn care, renovation, and debris removal products at [www.billygoat.com](http://www.billygoat.com)

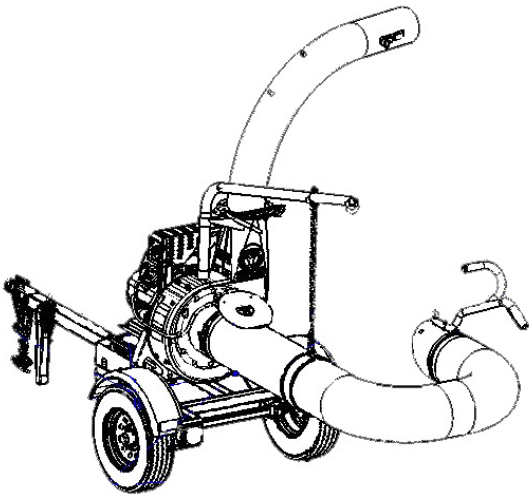
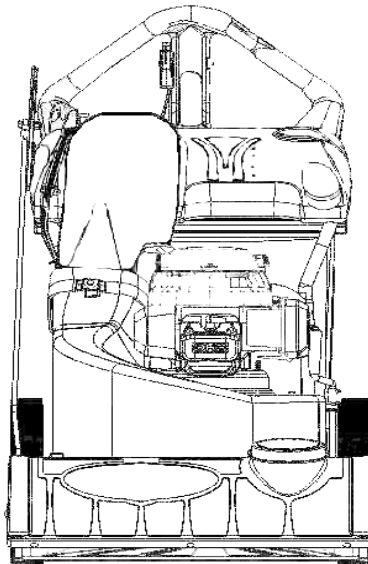
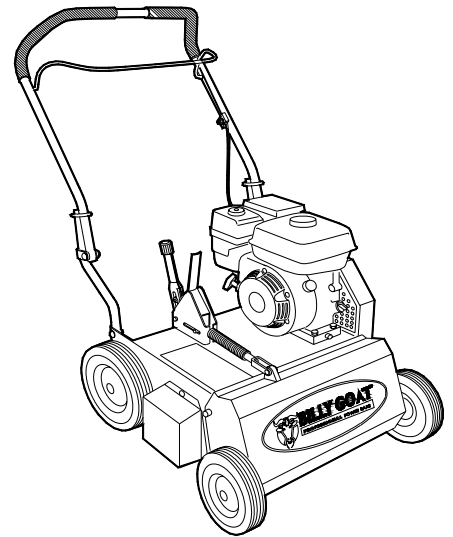
**DL VACUUM****MULTI VACUUM****POWER RAKE**



## Free Manuals Download Website

<http://myh66.com>

<http://usermanuals.us>

<http://www.somanuals.com>

<http://www.4manuals.cc>

<http://www.manual-lib.com>

<http://www.404manual.com>

<http://www.luxmanual.com>

<http://aubethermostatmanual.com>

Golf course search by state

<http://golfingnear.com>

Email search by domain

<http://emailbydomain.com>

Auto manuals search

<http://auto.somanuals.com>

TV manuals search

<http://tv.somanuals.com>