

**BUILT-UNDER OVEN  
FOUR ENCASTRABLE**

**BIO 7443**

**Gebrauchsanleitung**

**Blomberg**



## **Please read this manual first.**

Dear Customer,

We would like you to obtain best performance with your product that has been manufactured in modern facilities and passed through strict quality control procedures.

Therefore, we advise you to read through this User Manual carefully before using your product and keep it for future reference. If you hand over the product to someone else, deliver the User Manual as well.

## **The User Manual will help you use the product in a fast and safe way.**

- Read the User Manual before installing and operating the product.
- You must strictly observe the safety instructions.
- Keep this User Manual within easy reach for future reference.
- Also read other documents supplied with the product.  
Remember that this User Manual may also be applicable for several other models.  
Differences between models are explicitly identified in the manual.

## **Explanation of symbols**

Throughout this User Manual the following symbols are used:

 Important information or useful hints about usage.

 Warning for hazardous situations with regard to life and property.

 Warning for electric shock.

 Warning for risk of fire.

 Warning for hot surfaces.



**Arçelik A.Ş.**  
Karaağaç caddesi No:2-6  
34445 Sütlüce/İstanbul/TURKEY  
Made in TURKEY

# Table of Contents

---

<b>1</b>	<b>General information</b> .....	<b>4</b>	Initial heating .....	17
	Overview .....	4		
	Technical specifications .....	5		
	Accessories .....	5		
<b>2</b>	<b>Important safety instructions</b> 7		<b>5</b>	<b>How to operate the oven</b> .... <b>18</b>
	General safety.....	7		General information on baking, roasting and grilling .....
	Intended use .....	8		18
	Safety for children.....	8		How to operate the electric oven.....
	Safety when working with electricity .8			19
<b>3</b>	<b>Installation</b> .....	<b>9</b>		Operating modes.....
	Before installation .....	9		19
	Installation and connection.....	11		Using the oven clock.....
	Disposal .....	14		21
	Disposing of packaging material .....	14		Using the keylock.....
	Future Transportation .....	14		22
	Disposing of the old product .....	14		Using the clock as an alarm .....
<b>4</b>	<b>Preparation</b> .....	<b>16</b>		23
	Tips for saving energy .....	16		Cooking times table .....
	Initial use.....	16		24
	Initial time setting.....	16		How to operate the grill .....
	First cleaning of the appliance.....	17		26
				Cooking times table for grilling .....
				26
<b>6</b>	<b>Maintenance and care</b> .....	<b>27</b>	<b>6</b>	<b>Maintenance and care</b> .....
	General information .....	27		27
	Cleaning the control panel.....	27		General information .....
	Cleaning the oven .....	27		27
	Removing the oven door.....	28		Cleaning the oven .....
	Removing the door inner glass .....	28		27
	Replacing the oven lamp .....	29		Removing the oven door.....
<b>7</b>	<b>Troubleshooting</b> .....	<b>31</b>		28
				Removing the door inner glass .....
				28
				Replacing the oven lamp .....
				29

# 1 General information

## Overview

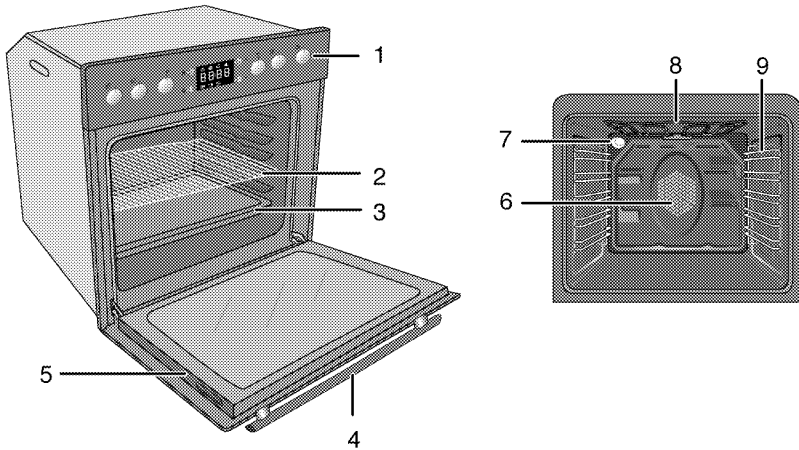

- |   |               |   |                                |
|---|---------------|---|--------------------------------|
| 1 | Control panel | 6 | Fan motor (behind steel plate) |
| 2 | Wire shelf    | 7 | Lamp                           |
| 3 | Tray          | 8 | Top heating element            |
| 4 | Handle        | 9 | Shelf positions                |
| 5 | Door          |   |                                |

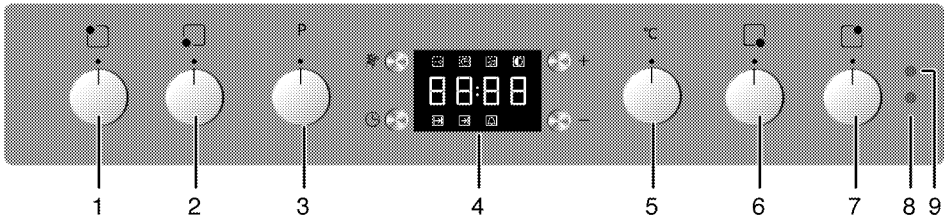

- |   |   |   |  |
|---|---|---|--|
| 1 | Single-circuit cooking plate Rear left  | 6 | Single-circuit cooking plate Front right |
| 2 | Single-circuit cooking plate Front left | 7 | Single-circuit cooking plate Rear right  |
| 3 | Function knob                           | 8 | Thermostat lamp                          |
| 4 | Digital timer                           | 9 | Warning lamp                             |
| 5 | Thermostat knob                         |   |  |

## Technical specifications

Voltage / frequency	220- 240 V~/380-415 V 3N ~ 50 Hz
Total power consumption	max. 9.5 kW
Fuse	min. 40 A
Cable type / section	H05VV-FG 3 x 4.0 mm <sup>2</sup> (220-240 V) / 5 x 2.5 mm <sup>2</sup> (380-415 V)
Cable length	max. 2 m
External dimensions (height / width / depth)	595 mm/594 mm/567 mm
Installation dimensions (height / width / depth)	**590 or 600 mm/560 mm/min. 550 mm
Main oven	<b>Multifunction oven</b>
Energy efficiency class <sup>#</sup>	A
Inner lamp	15/25 W
Grill power consumption	2.2 kW

<sup>#</sup> Basics: Information on the energy label of electrical ovens is given in accordance with the EN 50304 standard. Those values are determined under standard load with bottom-top heater or fan assisted heating (if any) functions.

Energy efficiency class is determined in accordance with the following prioritization depending on whether the relevant functions exist on the product or not. 1-Cooking with eco-fan, 2- Turbo slow cooking, 3- Turbo cooking, 4- Fan assisted bottom/top heating, 5-Top and bottom heating.

\*\* See. *Installation, page 9.*

 Important  
Technical specifications may be changed without prior notice to improve the quality of the product.

 Important  
Figures in this manual are schematic and may not exactly match your product.

 Important  
Values stated on the product labels or in the documentation accompanying it are obtained in laboratory conditions in accordance with relevant standards. Depending on operational and environmental conditions of the product, these values may vary.

## Accessories

 Important  
Accessories supplied can vary depending on the product model. Not every accessory described in the user manual may exist on your product.

### Oven tray

Used for pastries, frozen foods and big roasts.

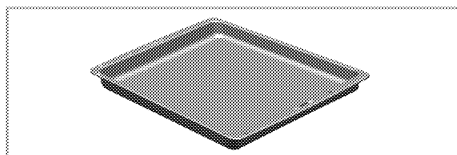

### Deep tray

Used for pastries, large roasts, juicy dishes, and for collecting the fat while grilling.

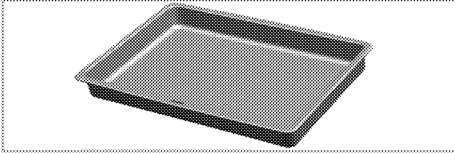

### Cake tray

Used for pastries such as cookies and biscuits.

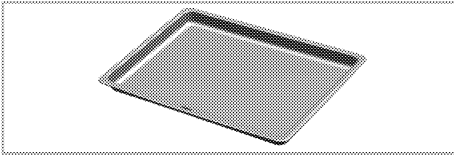

### Small oven tray

Used for small portions. This oven tray is placed onto the wire shelf.

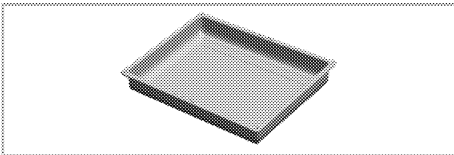

### Wire Shelf

Used for roasting and for placing the food to be baked, roasted or cooked in casserole dishes to the desired rack.

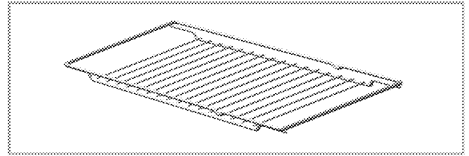
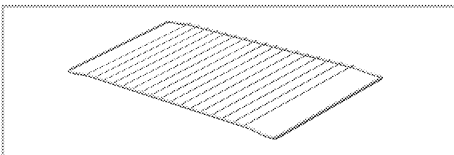

### Placing the wire shelf and tray onto the telescopic racks properly

Telescopic racks allow you to install and remove the trays and wire shelf easily.

When using the tray and wire shelf with telescopic racks, make sure that the pins at the rear section of the telescopic rack stands against the edges of the wire shelf and tray.

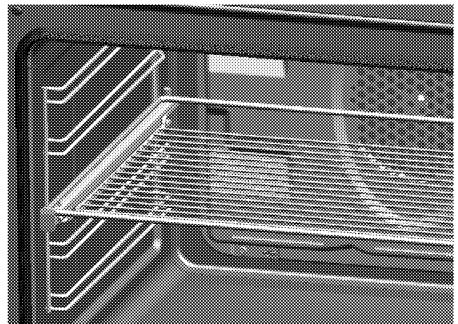
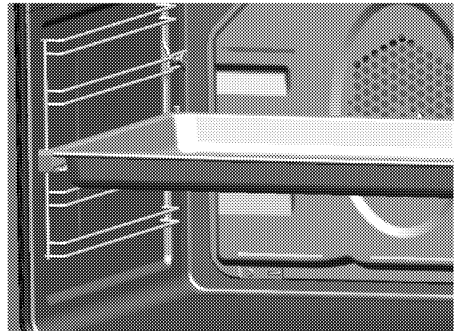

## 2 Important safety instructions

---

This section contains safety instructions that will help you avoid risk of injury and damage. All warranties will become void if you do not follow these instructions.

### General safety

- This product is not intended to be used by persons with physical, sensory or mental disorders or unlearned or inexperienced people (including children) unless they are attended by a person who will be responsible for their safety or who will instruct them accordingly for use of the product.  
Children must be supervised to prevent them from tampering with the product.
  - Connect the product to an earthed outlet/line protected by a fuse of suitable capacity as stated in the "Technical specifications" table. Have the earthing installation made by a qualified electrician while using the product with or without a transformer. Our company shall not be liable for any problems arising due to the product not being earthed in accordance with the local regulations.
  - If the supply cord is damaged, it must be replaced by the manufacturer, its service agent or similar qualified persons in order to avoid a hazard.
  - Do not operate the product if it is defective or has any visible damage.
  - Do not carry out any repairs or modifications on the product.
- However, you may remedy some troubles that do not require any repairs or modifications. See *Troubleshooting, page 31*.
- Never wash down the product with water! There is the risk of electric shock!
  - Never use the product when your judgment or coordination is impaired by the use of alcohol and/or drugs.
  - Product must be disconnected from the mains during installation, maintenance, cleaning and repair procedures.
  - Be careful when using alcoholic drinks in your dishes. Alcohol evaporates at high temperatures and may cause fire since it can ignite when it comes into contact with hot surfaces.
  - Do not heat closed tins and glass jars in the oven. The pressure that would build-up in the tin/jar may cause it to burst.
  - Do not place any flammable materials close to the product as the sides may become hot during use.
  - Do not place baking trays, dishes or aluminium foil directly onto the bottom of the oven. The heat accumulation might damage the bottom of the oven.
  - Keep all ventilation slots clear of obstructions.
  - Product may be hot when it is in use. Never touch the hot burners, inner sections of the oven, heaters and etc.



- Always use heat resistant oven gloves when putting in or removing dishes into/from the hot oven.
- Do not use the product with front door glass removed or cracked.
- Rear surface of the oven gets hot when it is in use. Make sure that the gas/electrical connection does not contact the rear surface; otherwise, connections can get damaged.
- Do not trap the mains cable between the oven door and frame and do not route it over hot surfaces. Otherwise, cable insulation may melt and cause fire as a result of short circuit.
- Make sure that the product function knobs are switched off after every use.

### Intended use

This product is designed for domestic use. Commercial use will void the guarantee.

"CAUTION: This appliance is for cooking purposes only. It must not be used for other purposes, for example room heating."

This product should not be used for warming the plates under the grill, drying towels, dish cloths etc. by hanging them on the oven door handles. This product should also not be used for room heating purposes. The manufacturer shall not be liable for any damage caused by improper use or handling errors.

The oven can be used for defrosting, baking, roasting and grilling food.

## SAVE THESE INSTRUCTIONS

### Safety for children

- Electrical and/or gas products are dangerous to children. Keep children away from the product when it is operating and do not allow them to play with the product.
- Accessible parts of the appliance will become hot whilst the appliance is in use. Children should be kept away until the product has cooled down.
- "**CAUTION:** Accessible parts may be hot when the grill is in use. Young children should be kept away."
- Do not place any items above the appliance that children may reach for.
- When the door is open, do **not** load any heavy object on it and do **not** allow children to sit on it. It may overturn or door hinges may get damaged.
- The packaging materials will be dangerous for children. Keep the packaging materials away from children. Please dispose of all parts of the packaging according to environmental standards.

### Safety when working with electricity

Defective electric equipment is one of the major causes of house fires.

- Any work on electrical equipment and systems should only be carried out by authorized and qualified persons.
- In case of any damage, switch off the product and disconnect it from the mains. To do this, turn off the fuse at home.
- Make sure that fuse rating is compatible with the product.

### 3 Installation

---

Product must be installed by a qualified person in accordance with the regulations in force. The manufacturer shall not be held responsible for damages arising from procedures carried out by unauthorized persons which may also void the warranty.

---

 Important  
Preparation of location and electrical and gas installation for the product is under customer's responsibility.

---

 DANGER

The product must be installed in accordance with all local gas and/or electrical regulations.

---

 DANGER  
Prior to installation, visually check if the product has any defects on it. If so, do not have it installed.  
Damaged products cause risks for your safety.

---

#### Before installation

The appliances are intended for installation in commercially available kitchen cabinets. A safety distance must be left between the appliance and the kitchen walls and furniture. See figure (values in mm).

- It can also be used in a free standing position. Allow a

minimum distance of 750 mm above the hob surface.

- (\*) If a cooker hood is to be installed above the cooker, refer to cooker hood manufacturer' instructions regarding installation height (min 650 mm).
- Remove packaging materials and transport locks.
- Surfaces, synthetic laminates and adhesives used must be heat resistant (100 °C minimum).
- Power to the hob is supplied from the oven. Both appliances must be installed on top of each other.
- Cut aperture for the hob in worktop as per installation dimensions.
- Seal cut edges and bordering edges.
- Worktop and kitchen cabinets must be set level and fixed.
- The hob may be installed with only **one** edge next the higher cabinets, appliances or walls.
- Some space must remain between the oven's rear wall and the kitchen wall for air to circulate.
- If there is a drawer beneath the oven, a shelf must be installed between oven and drawer.
- Carry the appliance with at least two persons.



### Important

Do not install the appliance next to refrigerators or freezers. The heat emitted by the appliance will lead to an increased energy consumption of cooling appliances.



### NOTICE

If the appliance has wire handles, push the handles back into the side walls after moving the appliance.



### NOTICE

The door and/or handle must not be used for lifting or moving the appliance.

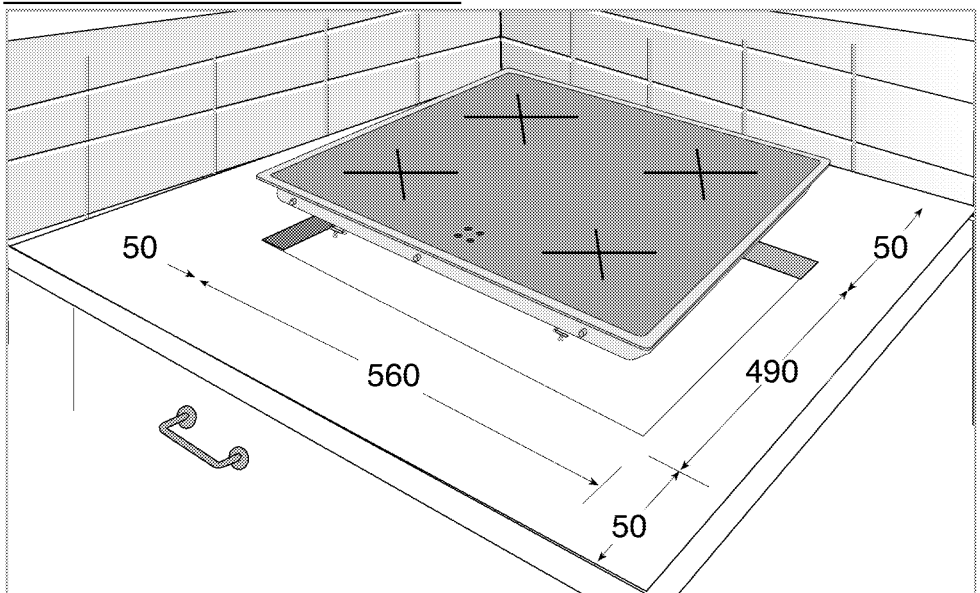

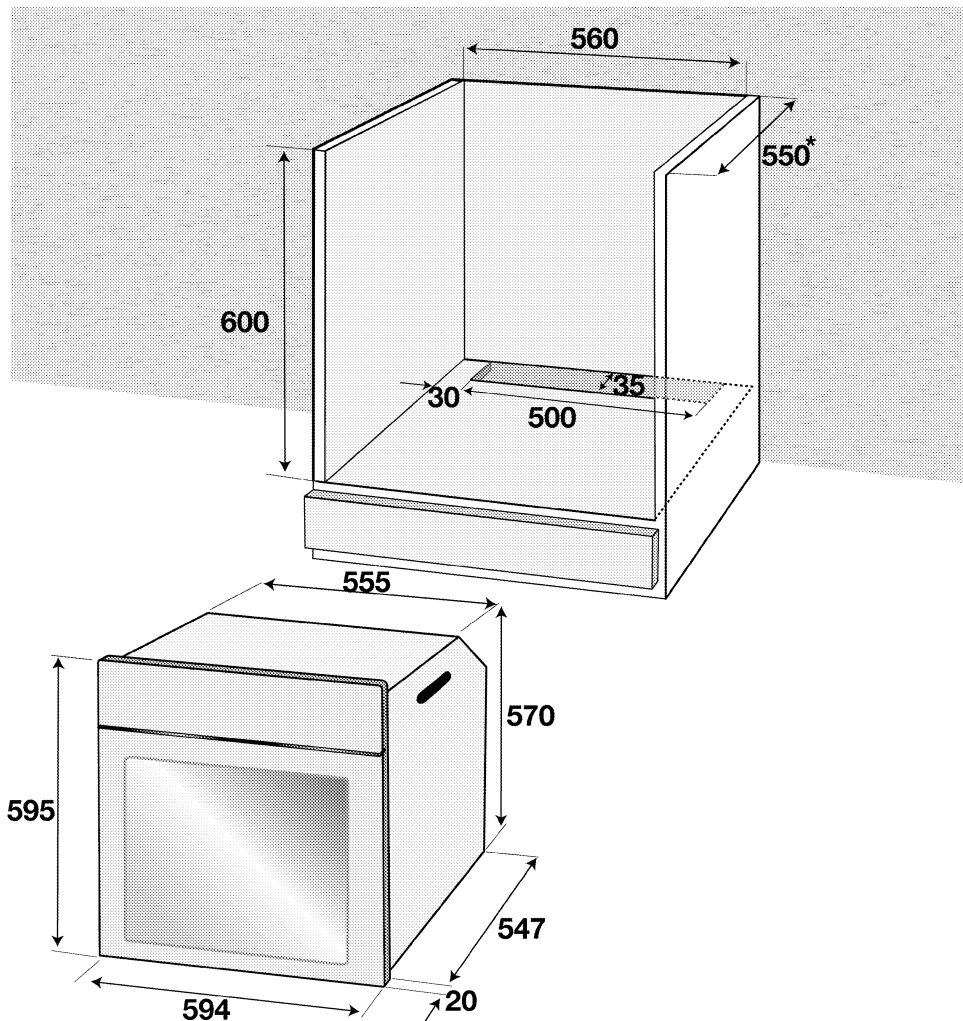

\* min.

## Installation and connection

- The product must be installed in accordance with all local gas and electrical regulations.

### Electrical connection

Connect the product to a grounded outlet/line protected by a fuse of

suitable capacity as stated in the "Technical specifications" table. Have the grounding installation made by a qualified electrician while using the product with or without a transformer. Our company shall not be liable for any damages that will arise due to using the product without a grounding installation in accordance with the local regulations.



**DANGER**

Risk of electric shock, short circuit or fire by unprofessional installation!

The appliance may be connected to the mains supply only by an authorized qualified person and the appliance is only guaranteed after correct installation.

---



**DANGER**

Risk of electric shock, short circuit or fire by damage of the mains lead!

The mains lead must not be clamped, bent or trapped or come into contact with hot parts of the appliance.

If the mains lead is damaged, it must be replaced by a qualified electrician.

---

- Connection must comply with national regulations.
  - The mains supply data must correspond to the data specified on the type label of the product. Open the front door to see the type label.
  - Power cable of your product must comply with the values in "Technical specifications" table.
- 



**DANGER**

Risk of electric shock!  
Before starting any work on the electrical installation, please disconnect the appliance from the mains supply.

---

## Connecting the power cable

1. **If a power cable is not supplied together with your product**, a power cable that you would select from the table (*Technical specifications, page 5*) in accordance with the electrical installation at your home must be connected to your product by following the instructions in cable diagram.

If it is not possible to disconnect all poles in the supply power, a disconnection unit with at least 3 mm contact clearance (fuses, line safety switches, contactors) must be connected and all the poles of this disconnection unit must be adjacent to (not above) the product in accordance with IEE directives. Failure to obey this instruction may cause operational problems and invalidate the product warranty.

---



**NOTICE**

Additional protection by a residual current circuit breaker is recommended.

---

2. Open the terminal block cover with a screwdriver.
3. Insert the power cable through the cable clamp below the terminal and secure it to the main body with the integrated screw on cable clamping component.
4. Connect the cables according to the supplied diagram.

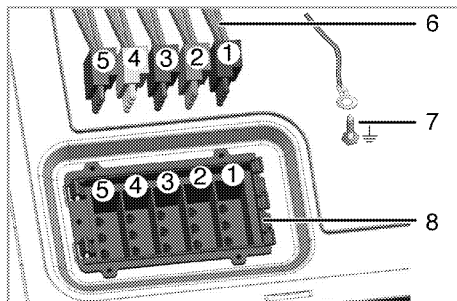
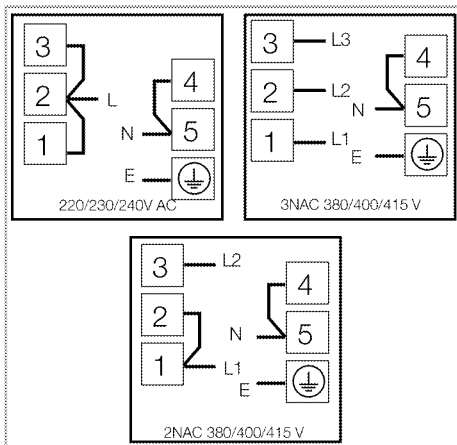

5. After completing the wire connections, close the terminal block cover.
6. Route the power cable so that it will not contact the product and get squeezed between the product and the wall.



#### NOTICE

Power cable must not be longer than 2 m because of safety reasons.

- 1 Red
  - 2 Black
  - 3 White
  - 4 Blue
  - 5 Green
  - 6 Cables coming from the hob
  - 7 Grounding cable connection (Green/Yellow)
  - 8 Oven cable connection inputs (terminal)
5. Slide the oven into the cabinet, align and secure it while making sure that the power cable is not broken and/or trapped.

### Installing the products

1. Fix the hob.
2. Make oven connections.
3. Slide the oven into the cabinet until half way.
4. Connect the hob to the oven.

### Installing the product

1. Slide the oven into the cabinet, align and secure it while making sure that the power cable is not broken and/or trapped.

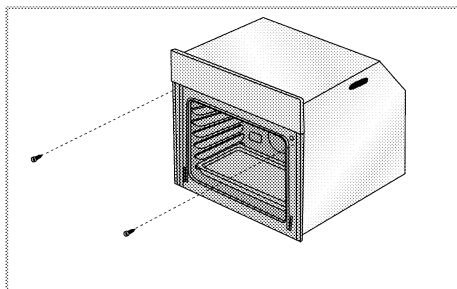

Secure the oven with 2 screws as illustrated.

## For products with cooling fan

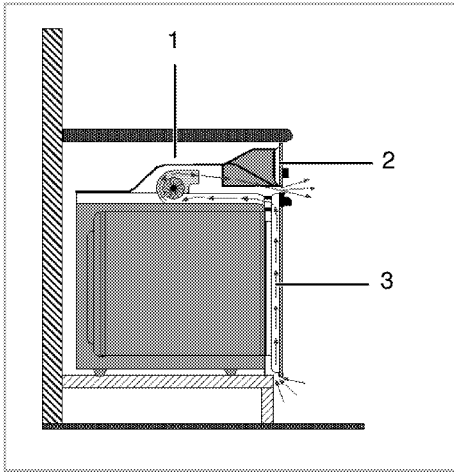

- 1 Cooling fan
- 2 Control panel
- 3 Door

The built-in cooling fan cools both the built-in cabinet and the front of the product.

- 
- NOTICE**  
Cooling fan continues to operate for about 20-30 minutes after the oven is switched off.

## Final check

1. Plug in the power cable and switch on the product's fuse.
2. Check the functions.

## Disposal

### Disposing of packaging material

Packaging materials are dangerous to children. Keep packaging materials in a safe place out of reach of children. Packaging materials of the product are manufactured from recyclable materials. Dispose of them properly and sort in accordance with recycled

waste instructions. Do not dispose of them with normal domestic waste.

## Future Transportation

- Keep the product's original carton and transport the product in it. Follow the instructions on the carton. If you do not have the original carton, pack the product in bubble wrap or thick cardboard and tape it securely.
- To prevent the wire grill and tray inside the oven from damaging the oven door, place a strip of cardboard onto the inside of the oven door that lines up with the position of the trays. Tape the oven door to the side walls.
- Do not use the door or handle to lift or move the product.

- 
- NOTICE**  
Do not place other items on the top of the appliance. The appliance must be transported upright.

- 
- Important**  
Check the general appearance of your product for any damages that might have occurred during transportation.

## Disposing of the old product



Dispose of the old product in an environmentally friendly manner. This equipment bears the selective sorting symbol for waste electrical and electronic equipment (WEEE). This means that this equipment must be

handled pursuant to European Directive 2002/96/EC in order to be recycled or dismantled to minimize its impact on the environment. For further information, please contact local or regional authorities.

Refer to your local dealer or solid waste collection centre in your area to learn how to dispose of your product. Before disposing of the product, cut off the power cable plug and make the door lock (if any) unusable to avoid dangerous conditions to children.



## 4 Preparation

### Tips for saving energy

The following information will help you to use your appliance in an ecological way, and to save energy:

- Use dark coloured or enamel coated cookware in the oven since the heat transmission will be better.
- While cooking your dishes, perform a preheating operation if it is advised in the user manual or cooking instructions.
- Do not open the door of the oven frequently during cooking.
- Try to cook more than one dish in the oven at the same time whenever possible. You can cook by placing two cooking vessels onto the wire shelf.
- Cook more than one dish one after another. The oven will already be hot.
- You can save energy by switching off your oven a few minutes before the end of the cooking time. Do not open the oven door.
- Defrost frozen dishes before cooking them.

### Initial use

#### Initial time setting

 Important  
Before using the oven the clock time must be set. If the clock time is not set, the oven will not work.

 NOTICE  
While making any adjustment, related symbols on the clock will flash.

Press (5) or (6) keys to set the time after the oven is energized for the first time.

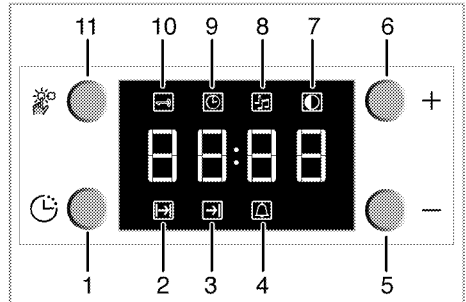

- 1 Program key
- 2 Cooking time
- 3 End of cooking time
- 4 Alarm
- 5 Minus key
- 6 Plus key
- 7 Screen brightness setting
- 8 Alarm volume
- 9 Current time
- 10 Keylock
- 11 Adjustment key

After setting the time, you can start and end the cooking by selecting the desired position with temperature button and function button.

 Important  
If the current time is not set, time setting will start increasing/moving up from **12:00**. Clock symbol '9' will be displayed to indicate that the current time has not been set. This symbol will disappear once the time is set.

 Important  
Current time settings are cancelled in case of power failure. It needs to be readjusted.

To change the time of the day you have previously set:

1. Press (11) key to activate current time symbol '9'.
2. Press (5) or (6) keys to set the current time.

### Changing screen brightness adjustment

1. Press (11) key to activate screen brightness symbol '7' for screen brightness adjustment.
  2. Press (5) or (6) keys to set the desired brightness.
- » Selected brightness level will appear as **d-01**, **d-02** or **d-03** on the display.

### First cleaning of the appliance

#### NOTICE

The surface may get damaged by some detergents or cleaning materials.

Do not use aggressive detergents, cleaning powder/cream or any sharp objects.

1. Remove all packaging materials.
2. Wipe the surfaces of the appliance with a damp cloth or sponge and dry with a cloth.

### Initial heating

Heat up the product for about 30 minutes and then switch it off. Thus, any production residues or layers will be burnt off and removed.

---

#### WARNING

Hot surfaces may cause burns!  
Do not touch the hot surfaces of the appliance. Use oven gloves.  
Keep children away from the appliance.

---

### Electric oven

1. Take all baking trays and the wire grill out of the oven.
2. Close the oven door.
3. Select Static position.
4. Select the highest grill power; See *How to operate the electric oven, page 19*.
5. Operate the oven for about 30 minutes.
6. Turn off your oven; See *How to operate the electric oven, page 19*

### Grill oven

1. Take all baking trays and the wire grill out of the oven.
  2. Close the oven door.
  3. Select the highest grill power; see *How to operate the grill, page 26*.
  4. Operate the oven about 30 minutes.
  5. Turn off your grill; see *How to operate the grill, page 26*
- 

#### Important

Smell and smoke may emit during first heating. Ensure that the room is well ventilated.

---

## 5 How to operate the oven

---

### General information on baking, roasting and grilling

---

 **DANGER**  
Risk of scalding by hot steam!  
Take care when opening the oven door as steam may escape.

---

#### Tips for baking

- Use non-sticky coated appropriate metal plates or aluminum vessels or heat-resistant silicone molds.
- Make best use of the space on the rack.
- Place the baking mold in the middle of the shelf.
- Select the correct rack position before turning the oven or grill on. Do not change the rack position when the oven is hot.
- Keep the oven door closed.

#### Tips for roasting

- Treating whole chicken, turkey and big-piece meats with dressings such as lemon juice and black pepper before cooking will increase the cooking performance.
- It lasts about 15 to 30 minutes longer to roast the meat with bones when compared to roasting the same size of meat without bones.
- Each centimeter of the meat thickness requires approximately 4 to 5 minutes of cooking time.
- Let meat rest in the oven for about 10 minutes after the cooking time is over. The juice is better distributed all over the roast and

does not run out when the meat is cut.

- Fish should be placed on the middle or lower rack in a heat-resistant plate.

#### Tips for grilling

When meat, fish and poultry are grilled, they quickly get brown, have a nice crust and do not get dry. Flat pieces, meat skewers and sausages are particularly suited for grilling as are vegetables with high water content such as tomatoes and onions.

- Distribute the pieces to be grilled on the wire shelf or in the baking tray with wire shelf in such a way that the space covered does not exceed the size of the heater.
- Slide the wire shelf or baking tray with grill into the desired level in the oven. If you are grilling on the wire shelf, slide the baking tray to the lower rack to collect fats. Add some water in the tray for easy cleaning.

---

 **NOTICE**  
**Fire danger due to food which is unsuitable for grilling!**

Only use food for grilling which is suitable for intensive grilling heat. Do not place the food too far in the back of the grill. This is the hottest area and fat food may catch fire.

---

## How to operate the electric oven

### Important

Before using the oven the clock time must be set. If the clock time is not set, the oven will not work.

### Select temperature and operating mode



- 1 Function knob
- 2 Thermostat knob

Your oven is equipped with pop-out knobs that protrude when you press them.

1. Press inwards to protrude the knob and then turn it to make the desired setting.

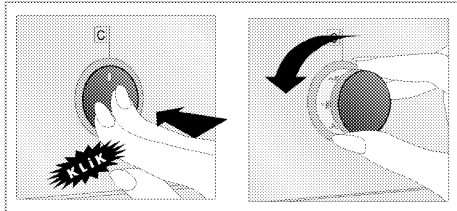

2. When the cooking process is finished, turn the knob to off (upper) position and press it inwards.

1. Set the Temperature knob to the desired temperature.
2. Set the Function knob to the desired operating mode.

» Oven heats up to the adjusted temperature and maintains it. During heating, temperature lamp stays on.

### Switching off the electric oven

Turn the function knob and temperature knob to off (upper) position.

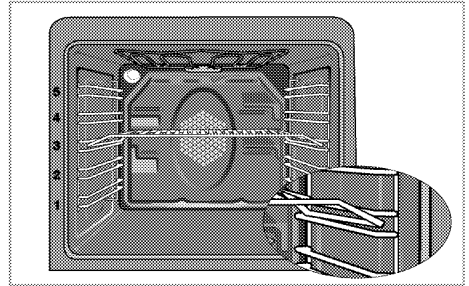

### Rack positions (For models with wire shelf)

It is important to place the wire shelf onto the side rack correctly. Wire shelf must be inserted between the side racks as illustrated in the figure. Do not let the wire shelf stand against the rear wall of the oven. Slide your wire shelf to the front section of the rack and settle it with the help of the door in order to obtain a good grill performance.

### Operating modes

The order of operating modes shown here may be different from the arrangement on your product.

### Top and bottom heating



Top and bottom heating are in operation. Food is heated simultaneously from the top and bottom. For example, it is suitable for cakes, cookies and casseroles in baking trays. Cook with one tray only.

### Bottom heating



Only bottom heating is in operation. It is suitable for pizza and for subsequent browning of food from the bottom.

### Fan supported bottom/top heating



Top heating, bottom heating plus fan (in the rear wall) are in operation. Hot air is evenly distributed throughout the oven rapidly by means of the fan. Cook with one tray only.

### Operating with fan



The oven is not heated. Only the fan (in the rear wall) is in operation. Frozen granular food is thawed slowly at room temperature and cooked food is cooled down.

### Fan Heating



Fan assisted heating (in the rear wall) is in operation. Hot air is evenly distributed throughout the oven rapidly by means of the fan. In most cases, preheating is not required. Suitable for cooking your food in different rack levels. Suitable for cooking with multi trays.

### "3D" function



Top heating, bottom heating and fan assisted heating (in the rear wall) are in operation. Food is cooked evenly and quickly all around. Cook with one tray only.

### Full grill



Large grill at the ceiling of the oven is in operation. It is suitable for grilling large amount of meat.

- Put big or medium-sized portions in correct rack position under the grill heater for grilling.
- Set the temperature to maximum level.
- Turn the food after half of the grilling time.

### Grill+Fan



Grilling effect is not as strong as in Full Grill

- Put small or medium-sized portions in correct shelf position under the grill heater for grilling.
- Set the desired temperature.
- Turn the food after half of the grilling time.

## Using the oven clock

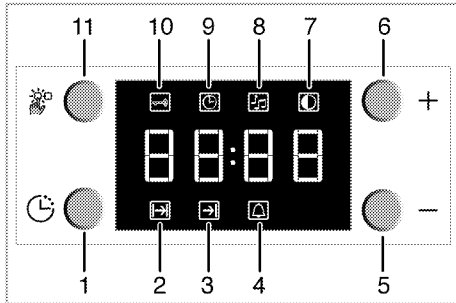

- 1 Program key
- 2 Cooking time
- 3 End of cooking time
- 4 Alarm
- 5 Minus key
- 6 Plus key
- 7 Screen brightness setting
- 8 Alarm volume
- 9 Current time
- 10 Keylock
- 11 Adjustment key

**Important**  
The maximum time to be set for the end of the cooking process is 23 hours and 59 minutes. In case of power cut, program will be canceled. Reprogram is needed.

**NOTICE**  
While making any adjustments, related symbols will flash on the display. You must wait for a short time for the settings to take effect.

**Important**  
If semi-automatic or full automatic operation mode is, time of the day cannot be adjusted.

**NOTICE**  
Cooking time will be displayed once the cooking starts.

## Activating semi-automatic operation mode

In this operation mode you may adjust how long the oven will automatically operate (cooking time) and the time it will be automatically turned off (end of cooking time).

1. To adjust the cooking time, press Program key (1) and activate the Cooking Time symbol **(2)**.
2. Adjust the cooking time with Minus (5) and Plus (6) keys.
  - » Cooking Time symbol remains lit (displayed continuously) after setting the cooking time.
3. To set the End of Cooking Time, Press Program key (1) and activate the Cooking Time symbol (3).
4. Press - (5) and + (6) keys to set the end of cooking time.
  - » Once the End of Cooking Time is set, End of Cooking symbol and Cooking symbol remain lit (displayed continuously). The End of Cooking Time symbol (3) will disappear as soon as the cooking starts.
5. Put your dish into the oven.
6. Select operation mode and temperature.
  - » Oven timer automatically calculates the startup time for cooking by using

the end of cooking time and the cooking period you have set. Selected operation mode is activated when the startup time of cooking has come and the oven is heated up to the set temperature. It maintains this temperature until the end of cooking time.

7. After the cooking process is completed, **"End"** appears on the displayed and the alarm will sound.
8. Alarm signal will sound for 2 minutes. To stop the alarm signal, just press any key. Alarm will be silenced and current time will be displayed.

---

**i** Important  
If you mute the alarm by pressing any key, the oven will restart operating.  
If you press any button at the end of the alarm period, the oven will restart operating.

---

9. Turn off the oven with the Temperature knob and Function knob.

### Switch on semi-automatic operation

In this operation mode, you may adjust the time period during which the oven will operate (cooking time).

1. To adjust the cooking time, Press Program key (1) and activate the Cooking Time symbol (2).
2. Press - (5) and + (6) keys to set the cooking time.

» Cooking Time symbol remains lit (displayed continuously) after setting the cooking time.

3. Put your dish into the oven.
4. Select operation mode and temperature.

» The oven will be heated up to the preset temperature and will maintain this temperature until the end of the cooking time you selected.

5. After the cooking process is completed, **"End"** appears on the displayed and the alarm will sound.
6. Alarm signal will sound for 2 minutes. To stop the alarm signal, just press any key.

Alarm will be silenced and current time will be displayed.

---

**i** Important  
If you mute the alarm by pressing any key, the oven will restart operating.  
If you press any button at the end of the alarm period, the oven will restart operating.

---

7. Turn off the oven with the Temperature knob and Function knob.

## Using the keylock

### Activating the keylock

You can prevent oven from being used by activating the Keylock function.

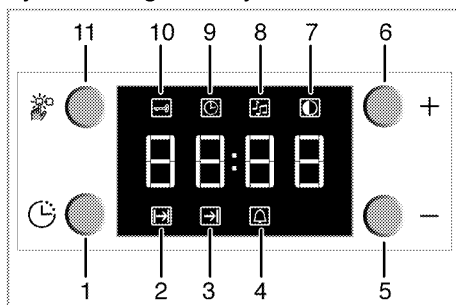

- 1 Program key
- 2 Cooking time
- 3 End of cooking time
- 4 Alarm
- 5 Minus key

- 6 Plus key
- 7 Screen brightness setting
- 8 Alarm volume
- 9 Current time
- 10 Keylock
- 11 Adjustment key

1. Press the key (11) to activate Keylock symbol (10).
  - » **"OFF"** will appear on the display.
2. Press Plus key (6) to activate the keylock.
  - » Once the keylock is activated, **"On"** appears on the display and the Keylock symbol (10) remains lit.

**NOTICE**

When the Keylock function is activated, control panel buttons except for the key (11) cannot be used.

### Deactivating the keylock

1. Press Adjustment key (11) to activate Keylock symbol (10).
  - » **"On"** will appear on the display.
2. Press Minus key (5) to deactivate the keylock.
  - » **"OFF"** will be displayed once the keylock is deactivated.

### Using the clock as an alarm

You can use the clock of the product for any warning or reminder apart from the cooking programme.

The alarm clock has no influence on the functions of the oven. It is only used as a warning. For example, this is useful when you want to turn food in the oven at a certain point of time.

Alarm clock will give a signal once the time you set is over.

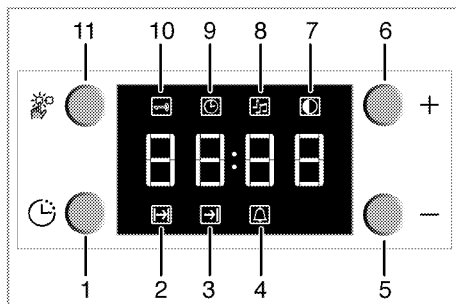

- 1 Program key
- 2 Cooking time
- 3 End of cooking time
- 4 Alarm
- 5 Minus key
- 6 Plus key
- 7 Screen brightness setting
- 8 Alarm volume
- 9 Current time
- 10 Keylock
- 11 Adjustment key

### Setting the alarm clock

1. Press Program key (1) to activate the alarm time symbol (4).



**Important**

The maximum alarm time can be 23 hours and 59 minutes.

2. Adjust the alarm time using Minus (5) and Plus (6) keys.
  - » Alarm symbol will remain lit and the alarm time will appear on the display once the alarm time is set.
3. At the end of the alarm time, Alarm Time symbol (4) will start flashing and the alarm signal is heard.

### Turning off the alarm

1. To stop the alarm, just press any key.



» Alarm will be silenced and current time will be displayed.

### If you want to cancel the alarm:

1. To reset the alarm time, press Program key (1) to activate the alarm time symbol (4).
2. Press and hold the Minus (5) key until "00:00" is displayed.

 Important  
Alarm time will be displayed. If the alarm time and cooking time are set concurrently, shortest time will be displayed.

### Changing alarm tone

1. Press Setting key (11) to activate the Alarm Tone symbol (8).

2. Adjust the desired tone using Minus (5) and Plus (6) keys.























» Selected alarm tone will appear as "b-01", "b-02" or "b-03" on the display.









### Cooking times table

 Important  
The values indicated in the table below are data indicative. They may vary according to the type of food as well as your preferences of cooking.

### Baking and roasting

 Important  
Level 1 is the **bottom** level in the oven.

Dish	Cooking level number		Rack position	Temperature (°C)	Cooking time (approx. in min.)
Cakes in tray*	One level		3	175	25 ... 30
Cakes in mould*	One level		2	180	40 ... 50
Cakes in cooking paper*	One level		3	175	25 ... 30
	2 levels		1 - 5	175	30 ... 40
	3 levels		1 - 3 - 5	180	45 ... 55
Sponge cake*	One level		3	200	5 ... 10
	2 levels		1 - 5	175	20 ... 30
Cookies*	One level		3	175	25 ... 30
	2 levels		1 - 5	170 ... 190	30 ... 40
	3 levels		1 - 3 - 5	175	35 ... 45
Dough pastry*	One level		2	200	30 ... 40
	2 levels		1 - 5	200	45 ... 55
	3 levels		1 - 3 - 5	200	55 ... 65
Rich pastry*	One level		2	200	25 ... 35
	2 levels		1 - 5	200	35 ... 45
	3 levels		1 - 3 - 5	190	45 ... 55
Leaven*	One level		2	200	35 ... 45
	2 levels		1 - 3	190	35 ... 45
Lasagna*	One level		2 - 3	200	30 ... 40
Pizza*	One level		2	200 ... 220	15 ... 20
Beef steak (whole) / Roast	One level		3	25 min. 250/max, then 180 ... 190	100 ... 120

Dish	Cooking level number		Rack position	Temperature (°C)	Cooking time (approx. in min.)
Leg of Lamb (casserole)	One level		3	25 min. 250/max, then 190	70 ... 90
	One level		3	25 min. 250/max, then 190	60 ... 80
Roasted chicken	One level		2	15 min. 250/max, then 180 ... 190	55 ... 65
	One level		2	15 min. 250/max, then 180 ... 190	55 ... 65
Turkey (5.5 kg)	One level		1	25 min. 250/max, then 180 ... 190	150 ... 210
	One level		1	25 min. 250/max, then 180 ... 190	150 ... 210
Fish	One level		3	200	20 ... 30
	One level		3	200	20 ... 30
When cooking with 2 trays at the same time, place the deeper tray on the upper rack and the other one on the lower rack. * It is suggested to perform preheating for all foods.					

In a cooking that requires preheating, preheat at the beginning of cooking until the thermostat lamp turns off.

### Tips for baking cake

- If the cake is too dry, increase the temperature by 10 and decrease the cooking time.
- If the cake is wet, use less liquid or lower the temperature by 10°C.
- If the cake is too dark on top, place it on a lower rack, lower the temperature and increase the cooking time.
- If cooked well on the inside but sticky on the outside use less liquid, lower the temperature and increase the cooking time.

### Tips for baking pastry

- If the pastry is too dry, increase the temperature by 10 and decrease the cooking time. Dampen the layers of dough with a

sauce composed of milk, oil, egg and yoghurt.

- If the pastry takes too long to bake, pay care that the thickness of the pastry you have prepared does not exceed the depth of the tray.
- If the upper side of the pastry gets browned, but the lower part is not cooked, make sure that the amount of sauce you have used for the pastry is not too much at the bottom of the pastry. Try to scatter the sauce equally between the dough layers and on the top of pastry for an even browning.



Important

Cook the pastry in accordance with the mode and temperature given in the cooking table. If the bottom part is still not browned enough, place it on one lower rack next time.

## Tips for cooking vegetables

- If the vegetable dish runs out of juice and gets too dry, cook it in a pan with a lid instead of a tray. Closed vessels will preserve the juice of the dish.
- If a vegetable dish does not get cooked, boil the vegetables beforehand or prepare them like canned food and put in the oven.

## How to operate the grill



Important

Before using the oven the clock time must be set. If the clock time is not set, the oven will not work.



**WARNING**

Hot surfaces may cause burns!

**Close oven door during grilling.**

## Switching on the grill

1. Turn the Function knob to the desired grill symbol.
  2. Then, select the desired grilling temperature.
  3. If required, perform a preheating of about 5 minutes.
- » Temperature light turns on.

## Switching off the grill

1. Turn the Function knob to Off (top) position.

## Grilling with electric grill

Food	Insertion level	Grilling time (approx.)
Fish	4...5	20...25 min. #
Sliced chicken	4...5	25...35 min.
Lamb chops	4...5	20...25 min.
Roast beef	4...5	25...30 min. #
Veal chops	4...5	25...30 min. #
Toast bread	4	1...2 min.

# depending on thickness

## Rack positions

Grill performance will decrease if the wire grill stands against rear part of the oven. Slide your wire grill to the front section of the rack and settle it with the help of the door in order to obtain the best grill performance.

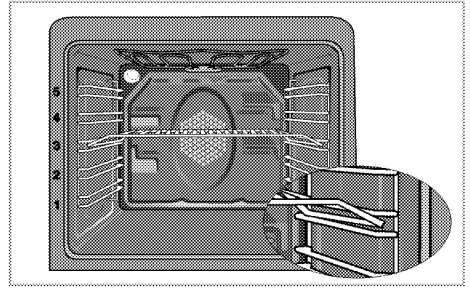

**NOTICE**

Do not use the upper level for grilling.



**NOTICE**

**Fire danger due to food which is unsuitable for grilling!**

Only use food for grilling which is suitable for intensive grilling heat. Do not place the food too far in the back of the grill. This is the hottest area and fat food may catch fire.

## Cooking times table for grilling

## 6 Maintenance and care

### General information

Service life of the product will extend and the possibility of problems will decrease if the product is cleaned at regular intervals.

**⚠ DANGER**  
Risk of electric shock!  
Switch off the electricity before cleaning appliance to avoid an electric shock.

**⚠ DANGER**  
Hot surfaces may cause burns!  
Allow the appliance to cool down before you clean it.

- Clean the product thoroughly after each use. In this way it will be possible to remove cooking residues more easily, thus avoiding these from burning the next time the appliance is used.
- No special cleaning agents are required for cleaning the product. Use warm water with washing liquid, a soft cloth or sponge to clean the product and wipe it with a dry cloth.
- Always ensure any excess liquid is thoroughly wiped off after cleaning and any spillage is immediately wiped dry.
- Do not use cleaning agents that contain acid or chloride to clean the stainless or inox surfaces and the handle. Use a soft cloth with a liquid detergent (not abrasive) to wipe those parts clean, paying attention to sweep in one direction.

**ℹ NOTICE**  
The surface may get damaged by some detergents or cleaning materials.  
Do not use aggressive detergents, cleaning powder/cream or any sharp objects.

**ℹ Important**  
Do not use steam cleaners for cleaning.

### Cleaning the control panel

Clean the control panel and control knobs with a damp cloth and wipe them dry.

**ℹ NOTICE**  
Damage of the control panel!  
Do not remove the control knobs for control panel cleaning.

### Cleaning the oven

#### To clean the side wall

1. Remove the front section of the side rack by pulling it in the opposite direction of the side wall.
2. Remove the side rack completely by pulling it towards you.

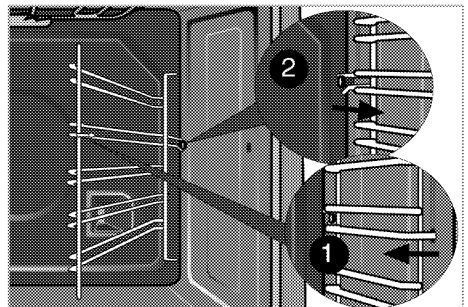

## Clean oven door

To clean the oven door, use warm water with washing liquid, a soft cloth or sponge to clean the product and wipe it with a dry cloth.

### Important

Don't use any harsh abrasive cleaners or sharp metal scrapers for cleaning the oven door. They could scratch the surface and destroy the glass.

## Removing the oven door

1. Open the front door (1).
2. Open the clips at the hinge housing (2) on the right and left hand sides of the front door by pressing them down as illustrated in the figure.

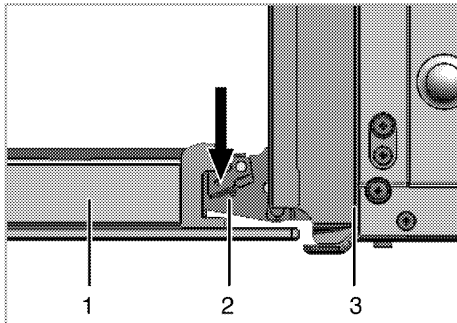

- 1 Front door
- 2 Hinge
- 3 Oven

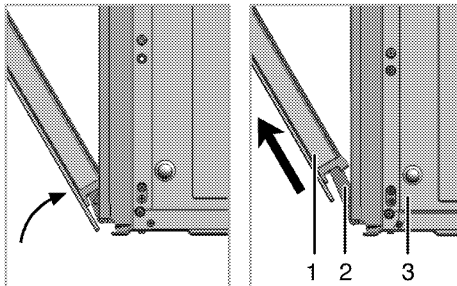

3. Move the front door to half-way.

4. Remove the front door by pulling it upwards to release it from the right and left hinges.

### NOTICE

Steps carried out during removing process should be performed in reverse order to install the door. Do not forget to close the clips at the hinge housing when reinstalling the door.

## Removing the door inner glass

The inner glass panel of the oven door can be removed for cleaning.

Open the oven door.

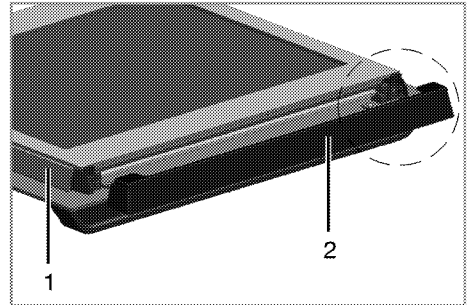

- 1 Frame
- 2 Plastic part

Pull towards yourself and remove the plastic part installed to upper section of the front door.

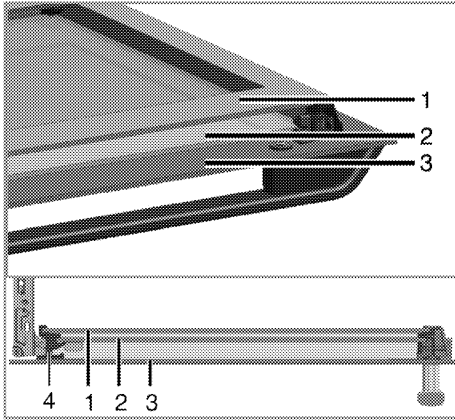

- 1 Innermost glass panel
- 2 Inner glass panel
- 3 Outer glass panel
- 4 Plastic glass panel slot-Lower

As illustrated in figure, raise the innermost glass panel (1) slightly in direction **A** and pull it out in direction **B**. Repeat the same procedure to remove the inner glass panel (2).

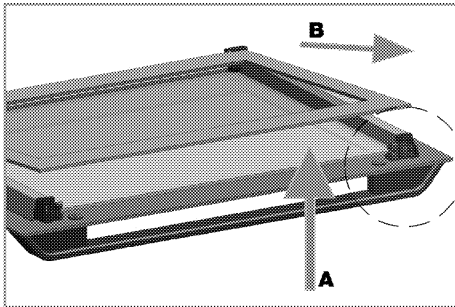

The first step to regroup the door is reinstalling inner glass panel (2). As illustrated in figure, place the chamfered corner of the glass panel so that it will rest in the chamfered corner of the plastic slot.

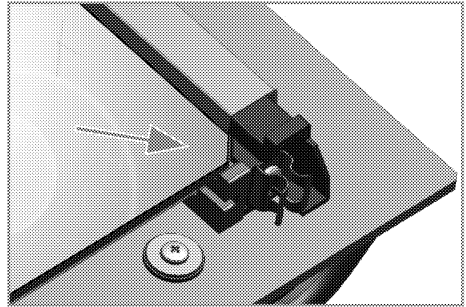

Inner glass panel (2) must be installed into the plastic slot close the innermost glass panel (1).

When installing the innermost glass panel (1), make sure that the printed side of the panel faces towards the inner glass panel.

It is important to seat lower corner of inner glass panel into the lower plastic slot.

Push the plastic part towards the frame until you hear a "click".

## Replacing the oven lamp

**⚠ DANGER**  
Hot surfaces may cause burns!  
Make sure that the appliance is switched off and cooled down in order to avoid the risk of an electrical shock.

**i Important**  
The oven lamp is a special electric light bulb that can resist up to 300 °C. See *Technical specifications, page 5* for details. Oven lamps can be obtained from Authorised Service Agents.



**NOTICE**

Position of lamp might vary from the figure.

---

**If your oven is equipped with a round lamp:**

1. Disconnect the product from mains.
2. Turn the glass cover counter clockwise to remove it.
3. Remove the oven lamp by turning it counter clockwise and replace it with the new one.
4. Install the glass cover.

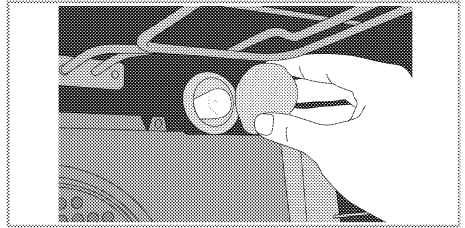

## 7 Troubleshooting

### Oven emits steam when it is in use.



Important

It is normal that steam escapes during operation. This is not a fault.

### Product emits metal noises while heating and cooling.



Important

When the metal parts are heated, they may expand and cause noise. This is not a fault.

### Product does not operate.

- The mains fuse is defective or has tripped. >>> *Check fuses in the fuse box. If necessary, replace or reset them.*
- Product is not plugged into the (grounded) socket. >>> *Check the plug connection.*
- Buttons/knobs/keys on the control panel do not function. >>> *Keylock may be enabled. Please disable it. (See. Using the keylock, page 22 )*

### Oven light does not work.

- Oven lamp is defective. >>> *Replace oven lamp.*
- Power is cut. >>> *Check if there is power. Check the fuses in the fuse box. If necessary, replace or reset the fuses.*

### Oven does not heat.

- Function and/or Temperature are not set. >>> *Set the function and the temperature with the Function and/or Temperature knob/key.*
- In models equipped with a timer, the timer is not adjusted. >>> *Adjust the time.*  
(In products with microwave oven, timer controls only microwave oven.)
- Power is cut. >>> *Check if there is power. Check the fuses in the fuse box. If necessary, replace or reset the fuses.*

### (In models with timer) Clock display is blinking or clock symbol is on.

- A previous power outage has occurred. >>> *Adjust the time / Switch of the product and switch it on again.*



Important

Consult the Authorised Service Agent or the dealer where you have purchased the product if you can not remedy the trouble although you have implemented the instructions in this section. Never attempt to repair a defective product yourself.



## Free Manuals Download Website

<http://myh66.com>

<http://usermanuals.us>

<http://www.somanuals.com>

<http://www.4manuals.cc>

<http://www.manual-lib.com>

<http://www.404manual.com>

<http://www.luxmanual.com>

<http://aubethermostatmanual.com>

Golf course search by state

<http://golfingnear.com>

Email search by domain

<http://emailbydomain.com>

Auto manuals search

<http://auto.somanuals.com>

TV manuals search

<http://tv.somanuals.com>