

LTC 8500 Series



Security Systems

EN

**Instruction Manual
Allegiant Microprocessor-
based Video Switcher/
Control Systems**

BOSCH

Important Safeguards

1. **Read, Follow, and Retain Instructions** - All safety and operating instructions should be read and followed before operating the unit. Retain instructions for future reference.
2. **Heed Warnings** - Adhere to all warnings on the unit and in the operating instructions.
3. **Attachments** - Attachments not recommended by the product manufacturer should not be used, as they may cause hazards.
4. **Installation Cautions** - Do not place this unit on an unstable stand, tripod, bracket, or mount. The unit may fall, causing serious injury to a person and serious damage to the unit. Use only manufacturer-recommended accessories, or those sold with the product. Mount the unit per the manufacturer's instructions. Appliance and cart combination should be moved with care. Quick stops, excessive force, or uneven surfaces may cause the appliance and cart combination to overturn.
5. **Cleaning** - Unplug the unit from the outlet before cleaning. Follow any instructions provided with the unit. Generally, using a damp cloth for cleaning is sufficient. Do not use liquid cleaners or aerosol cleaners.
6. **Servicing** - Do not attempt to service this unit yourself. Opening or removing covers may expose you to dangerous voltage or other hazards. Refer all servicing to qualified service personnel.
7. **Damage Requiring Service** - Unplug the unit from the main AC power source and refer servicing to qualified service personnel under the following conditions:
 - When the power supply cord or plug is damaged.
 - If liquid has been spilled or an object has fallen into the unit.
 - If the unit has been exposed to water and/or inclement weather (rain, snow, etc.).
 - If the unit does not operate normally, when following the operating instructions. Adjust only those controls specified in the operating instructions. Improper adjustment of other controls may result in damage, and require extensive work by a qualified technician to restore the unit to normal operation.
 - If the unit has been dropped or the cabinet damaged.
 - If the unit exhibits a distinct change in performance, this indicates that service is needed.
8. **Replacement Parts** - When replacement parts are required, the service technician should use replacement parts specified by the manufacturer or that have the same characteristics as the original part. Unauthorized substitutions may result in fire, electrical shock or other hazards.
9. **Safety Check** - Upon completion of servicing or repairs to the unit, ask the service technician to perform safety checks to ensure proper operating condition.
10. **Power Sources** - Operate the unit only from the type of power source indicated on the label. If unsure of the type of power supply to use, contact your dealer or local power company.
 - For units intended to operate from battery power, refer to the operating instructions.
 - For units intended to operate **with External Power Supplies**, use only the recommended approved power supplies.
 - For units intended to operate with a limited power source, this power source must comply with EN60950. Substitutions may damage the unit or cause fire or shock.
 - For units intended to operate at 24VAC, normal input voltage is **24VAC**. Voltage applied to the unit's power input should not exceed 30VAC. User-supplied wiring, from the 24VAC supply to unit, must be in compliance with electrical codes (Class 2 power levels). Do not ground the 24VAC supply at the terminals or at the unit's power supply terminals.
11. **Coax Grounding** - If an outside cable system is connected to the unit, ensure that the cable system is grounded. U.S.A. models only - Section 810 of the National Electrical Code, ANSI/NFPA No.70, provides information regarding proper grounding of the mount and supporting structure, grounding of the coax to a discharge unit, size of grounding conductors, location of discharge unit, connection to grounding electrodes, and requirements for the grounding electrode.
12. **Grounding** - This unit may be equipped with a 3-wire grounding plug (a plug with a third pin, for grounding). This safety feature allows the plug to fit into a grounding power outlet only. If unable to insert the plug into the outlet, contact an electrician to arrange replacement of the obsolete outlet. Do not defeat the safety purpose of the grounding plug.
 - Outdoor equipment should only be connected to the unit's inputs after this unit has had its grounding plug connected to a grounded outlet or its ground terminal properly connected to a ground source.
 - The unit's input connectors must be disconnected from outdoor equipment before disconnecting the grounding plug or grounding terminal.
 - Proper safety precautions such as grounding should be followed for any outdoor device connected to this unit.
13. **Lightning** - For added protection during a lightning storm, or when this unit is left unattended and unused for long periods of time, unplug the unit from the wall outlet and disconnect the cable system. This will prevent damage to the unit due to lightning and power line surges.

For Indoor Product

1. **Water and Moisture** - Do not use this unit near water - for example, in a wet basement, in an unprotected outdoor installation or in any area classified as a wet location.
2. **Object and Liquid Entry** - Never push objects of any kind into this unit through openings, as they might touch dangerous voltage points or create short circuits, resulting in a fire or electrical shock. Never spill liquid of any kind on the unit.
3. **Power Cord and Power Cord Protection** - For units intended to operate with 230VAC, 50Hz, the input and output power cord must comply with the latest versions of IEC Publication 227 or IEC Publication 245.
Power supply cords should be routed so they are not likely to be walked on or pinched. Pay particular attention to location of cords and plugs, convenience receptacles, and the point of exit from the appliance.
4. **Overloading** - Do not overload outlets and extension cords; this can result in a risk of fire or electrical shock.

For Outdoor Product

Power Lines - An outdoor system should not be located in the vicinity of overhead power lines, electric lights or power circuits, or where it may contact such power lines or circuits. When installing an outdoor system, extreme care should be taken to keep from touching power lines or circuits, as this contact might be fatal. U.S.A. models only - refer to the National Electrical Code Article 820 regarding installation of CATV systems.

For Rack-mount Product

1. **Ventilation** - Do not place this equipment in a built-in installation or rack, unless proper ventilation is provided, or the manufacturer's instructions were followed. The equipment must not exceed its maximum operating temperature requirements.
2. **Mechanical Loading** - When rack-mounting the equipment, ensure that a hazardous condition is not created by uneven mechanical loading.

Safety Precautions



CAUTION

RISK OF ELECTRIC SHOCK. DO NOT OPEN!



CAUTION: TO REDUCE THE RISK OF ELECTRIC SHOCK, DO NOT REMOVE COVER (OR BACK). NO USER SERVICEABLE PARTS INSIDE. REFER SERVICING TO QUALIFIED SERVICE PERSONNEL.



This symbol indicates the presence of uninsulated "dangerous voltage" within the product's enclosure that can cause an electric shock.



This symbol indicates the presence of important operating and maintenance (servicing) instructions in the literature accompanying the appliance.



Installation should be performed by qualified service personnel only in accordance with the National Electrical Code or applicable local codes.



Power Disconnect. Units with or without ON-OFF switches have power supplied to the unit whenever the power cord is inserted into the power source; however, the unit is operational only when the ON-OFF switch is in the ON position. The power cord is the main power disconnect for all units.

FCC & ICES INFORMATION

(U.S.A. and Canadian Models Only)

This device complies with part 15 of the FCC Rules. Operation is subject to the following two conditions:

- (1) This device may not cause harmful interference, and
- (2) This device must accept any interference received, including interference that may cause undesired operation.

NOTE: This equipment has been tested and found to comply with the limits for a Class B digital device, pursuant to Part 15 of the FCC Rules and ICES-003 of Industry Canada. These limits are designed to provide reasonable protection against harmful interference when the equipment is operated in a residential installation. This equipment generates, uses and can radiate radio frequency energy, and if not installed and used in accordance with the instructions, may cause harmful interference to radio communications. However, there is no guarantee that interference will not occur in a particular installation. If this equipment does cause harmful interference to radio or television reception, which can be determined by turning the equipment off and on, the user is encouraged to try to correct the interference by one or more of the following measures:

- Reorient or relocate the receiving antenna.
- Increase the separation between the equipment and receiver.
- Connect the equipment into an outlet on a circuit different from that to which the receiver is connected.
- Consult the dealer, or an experienced radio/TV technician for help.

Intentional or unintentional changes or modifications, not expressly approved by the party responsible for compliance, shall not be made. Any such changes or modifications could void the user's authority to operate the equipment. The user may find the following booklet, prepared by the Federal Communications Commission, helpful: [How to Identify and Resolve Radio-TV Interference Problems](#). This booklet is available from the U.S. Government Printing Office, Washington, DC 20402, Stock No. 004-000-00345-4.







Sécurité

	ATTENTION RISQUE D'ÉLECTROCUTION. NE PAS OUVRIR !	
ATTENTION : POUR ÉVITER TOUT RISQUE D'ÉLECTROCUTION, N'ESSAYEZ PAS DE RETIRER LE CAPOT (OU LE PANNEAU ARRIÈRE). CET APPAREIL NE CONTIENT AUCUN COMPOSANT SUSCEPTIBLE D'ÊTRE RÉPARÉ PAR L'UTILISATEUR. CONFIEZ LA RÉPARATION DE L'APPAREIL À DU PERSONNEL QUALIFIÉ.		
	Ce symbole signale que le produit renferme une « tension potentiellement dangereuse » non isolée susceptible de provoquer une électrocution.	
	Ce symbole invite l'utilisateur à consulter les instructions d'utilisation et d'entretien (dépannage) reprises dans la documentation qui accompagne l'appareil.	
	Attention : l'installation doit exclusivement être réalisée par du personnel qualifié, conformément au code national d'électricité américain (NEC) ou au code d'électricité local en vigueur.	
	Coupure de l'alimentation. Qu'ils soient pourvus ou non d'un commutateur ON/OFF, tous les appareils reçoivent de l'énergie une fois le cordon branché sur la source d'alimentation. Toutefois, l'appareil ne fonctionne réellement que lorsque le commutateur est réglé sur ON. Le débranchement du cordon d'alimentation permet de couper l'alimentation des appareils.	

Sicherheitshinweise

	VORSICHT ELEKTRISCHE SPANNUNG. NICHT ÖFFNEN!	
VORSICHT: UM EINEN ELEKTRISCHEN SCHLAG ZU VERMEIDEN, IST DIE ABDECKUNG (ODER RÜCKSEITE) NICHT ZU ENTFERNEN. ES BEFINDEN SICH KEINE TEILE IN DIESEM BEREICH, DIE VOM BENUTZER GEWARTET WERDEN KÖNNEN. LASSEN SIE WARTUNGSARBEITEN NUR VON QUALIFIZIERTEM WARTUNGSPERSONAL AUSFÜHREN.		
	Das Symbol macht auf nicht isolierte „gefährliche Spannung“ im Gehäuse aufmerksam. Dies kann zu einem elektrischen Schlag führen.	
	Der Benutzer sollte sich ausführlich über Anweisungen für die Bedienung und Instandhaltung (Wartung) in den begleitenden Unterlagen informieren.	
	Achtung! Die Installation sollte nur von qualifiziertem Kundendienstpersonal gemäß jeweils zutreffender Elektrovorschriften ausgeführt werden.	
	Unterbrechung des Netzanschlusses. Geräte mit oder ohne Netzschalter haben Spannung am Gerät anliegen, sobald der Netzstecker in die Steckdose gesteckt wird. Das Gerät ist jedoch nur betriebsbereit, wenn der Netzschalter (EIN/AUS) auf EIN steht. Wenn das Netzkabel aus der Steckdose gezogen wird, ist die Spannungszuführung zum Gerät vollkommen unterbrochen.	

Precauciones de Seguridad

	ATTENZIONE PERICOLO DI SCOSSA ELETTRICA. NON APRIRE.	
PRECAUCIÓN: PARA DISMINUIR EL RIESGO DE DESCARGA ELÉCTRICA, NO RETIRE LA CUBIERTA (NI LA PARTE POSTERIOR). NO EXISTEN PIEZAS DE RECAMBIO EN EL INTERIOR DEL EQUIPO. EL PERSONAL DE SERVICIO CUALIFICADO SE ENCARGA DE REALIZAR LAS REPARACIONES.		
	Este símbolo indica que existen puntos de tensión peligrosos sin aislamiento dentro de la cubierta de la unidad. Estos puntos pueden constituir un riesgo de descarga eléctrica.	
	El usuario debe consultar las instrucciones de funcionamiento y mantenimiento (reparación) en la documentación que se suministra con el aparato.	
	Atención: la instalación la debe realizar únicamente personal cualificado de conformidad con el National Electric Code o las normas aplicables en su país.	
	Desconexión de la alimentación. Las unidades con o sin interruptores de encendido/apagado reciben alimentación eléctrica siempre que el cable de alimentación esté conectado a la fuente de alimentación. Sin embargo, la unidad sólo funciona cuando el interruptor está en la posición de encendido. El cable de alimentación es la principal fuente de desconexión de todas las unidades.	

Veiligheidsmaatregelen

	VOORZICHTIG GEVAAR VOOR ELEKTRISCHE SCHOK. NIET OPENEN!	
<p>VOORZICHTIG: OPEN DE BEHUIZING OF DE ACHTERKANT VAN HET APPARAAT NIET. ZO VERMINDERT U HET RISICO OP ELEKTRISCHE SCHOKKEN. IN HET APPARAAT BEVINDEN ZICH GEEN ONDERDELEN DIE U ZELF KUNT REPAREREN. LAAT SERVICE EN ONDERHOUD UITVOEREN DOOR GEKWALIFICEERD PERSONEEL.</p>		
	<p>Dit symbool geeft aan dat er binnen in het apparaat ongeïsoleerde, gevaarlijke spanning aanwezig is die mogelijk elektrische schokken kan veroorzaken.</p>	
	<p>De gebruiker dient de bedienings- en onderhoudsvoorschriften te raadplegen in de documentatie die werd meegeleverd met het apparaat.</p>	
	<p>Attentie: het apparaat mag alleen door gekwalificeerd personeel worden geïnstalleerd. De installatie dient in overeenstemming met de nationale elektrische richtlijnen of de van toepassing zijnde lokale richtlijnen te worden uitgevoerd.</p>	
	<p>Spanning uitschakelen. Apparatuur met of zonder aan-uitschakelaar staat onder spanning zolang de stekker is aangesloten op de wandcontactdoos. De apparatuur is uitsluitend in werking als de aan-uitschakelaar aan staat. Het netsnoer is de "hoofdschakelaar" voor alle apparatuur.</p>	

Sicurezza

	ATTENZIONE PERICOLO DI SCOSSA ELETTRICA. NON APRIRE.	
<p>ATTENZIONE: PER RIDURRE IL RISCHIO DI SCOSSE ELETTRICHE NON RIMUOVERE LA COPERTURA (O IL PANNELLO POSTERIORE). L'UNITÀ NON CONTIENE COMPONENTI INTERNI RIPARABILI DALL'UTENTE. PER QUALSIASI INTERVENTO, RIVOLGERSI A PERSONALE TECNICO QUALIFICATO.</p>		
	<p>Questo simbolo indica la presenza di "tensione pericolosa" non isolata all'interno del contenitore del prodotto. Ciò comporta un potenziale rischio di scosse elettriche.</p>	
	<p>Si consiglia di consultare le istruzioni operative e di manutenzione (interventi tecnici) contenute nella documentazione fornita con il dispositivo.</p>	
	<p>Attenzione: l'installazione deve essere effettuata esclusivamente da personale tecnico qualificato in conformità con il National Electrical Code o con le normative locali vigenti.</p>	
	<p>Scollegamento dell'alimentazione. Le unità dotate o sprovviste di interruttori ON-OFF vengono alimentate quando si inserisce il cavo nella presa dell'alimentazione. L'unità è tuttavia in funzione solo quando l'interruttore ON-OFF si trova nella posizione ON. Il cavo di alimentazione costituisce il dispositivo di scollegamento dell'alimentazione principale per tutte le unità.</p>	

Medidas de Segurança

	CUIDADO RISCO DE CHOQUE ELÉCTRICO. NÃO ABRIR!	
<p>CUIDADO: PARA REDUZIR O RISCO DE CHOQUE ELÉCTRICO, NÃO RETIRE A TAMPA (OU A PARTE POSTERIOR). NO INTERIOR, NÃO EXISTEM PEÇAS QUE POSSAM SER REPARADAS PELO UTILIZADOR. REMETA A ASSISTÊNCIA PARA OS TÉCNICOS QUALIFICADOS.</p>		
	<p>Este símbolo indica a presença de "tensão perigosa" não isolada dentro da estrutura do produto, o que pode constituir risco de choque eléctrico.</p>	
	<p>O utilizador deve consultar as instruções de funcionamento e manutenção (assistência) nos documentos que acompanham o aparelho.</p>	
	<p>Atenção: a instalação deve ser executada apenas por técnicos qualificados da assistência, de acordo com o código eléctrico nacional ou os códigos locais aplicáveis.</p>	
	<p>Corte de corrente. As unidades com ou sem interruptores ON-OFF (ligar/desligar) recebem corrente sempre que o fio de alimentação está introduzido na fonte de alimentação; contudo, a unidade apenas está operacional quando o interruptor ON-OFF está na posição ON. O fio de alimentação destina-se a desligar a corrente em todas as unidades.</p>	

安全预防措施

	CAUTION RISK OF ELECTRIC SHOCK. DO NOT OPEN!	
<p>注意：为避免受到电击，不要拆除机盖（或后盖）。用户不得擅自维修里面的部件。有关维修事项，请咨询合格的维修人员。</p>		
	<p>此符号表示产品机壳内存在未绝缘的“危险电压”。这可能导致电击。</p>	
	<p>用户应参照设备附带的操作和维护（维修）说明。</p>	
	<p>注意：安装须由合格的维修人员遵照美国国家电工标准或相关电气规则进行。</p>	
	<p>断开电源。在电源线插入电源时，配备或未配备 ON-OFF 开关的设备都已通电；但设备只有在 ON-OFF 开关处于 ON 位置时才能工作。对于所有设备，电源线是断开电源的主要方式。</p>	

1. Unpacking	1
1.1 Parts List	1
2. Service	2
3. Description	3
4. Allegiant Feature Summary Table	5
5. System Components	7
5.1 LTC 8501 Series Systems	7
6. System Accessory Components	8
6.1 LTC 8540/00 Alarm Interface Unit	8
6.2 LTC 8568 and LTC 8768 Signal Distribution Units	8
6.3 IntuiKey Series KBD-Universal Keyboard.....	8
6.4 KBD-Rack Keyboard Mounting Kit.....	8
6.5 LTC 8555 Series Keyboards	9
6.6 LTC 8558/00 Keyboard Extension Cable.....	9
6.7 LTC 8557 Series Keyboard Extension Kits.....	9
6.8 LTC 8560 and LTC 8561 Series Receiver/Driver Units	9
6.9 AutoDome Series.....	9
6.10 LTC 8569, LTC 8570, LTC 8571, LTC 8572 Series Code Merger Units	10
6.11 LTC 8770 Switcher Follower Series.....	10
6.12 LTC 8712 Series Console Port Expander Units	10
6.13 LTC 8713 Alarm Port Expander Units.....	10
6.14 LTC 8780 Series Data Converter Units.....	11
6.15 LTC 8781 Series Data Converter Units.....	11
6.16 LTC 8016/90 Bilinx™ Data Interface Unit.....	11
6.17 LTC 8785 Series Code Converters	11
6.18 LTC 8782 Series Code Translator Units	11
6.19 LTC 8059/00 Master Control Software	12
6.20 LTC 8850/00 Windows Based Graphical User Interface Software	12
6.21 SFT-INTSRV Allegiant Integration Software	12
6.21.1 Integration Server.....	12
6.21.2 Virtual Allegiant Satellite Application Software	12
6.21.3 Allegiant Satellite Software Development Kit.....	13
6.22 LTC 8506/00 PC-to-Console Port RS-232 Cable	13
6.23 Logging Printer	14
7. Installation Procedure	16
7.1 Main CPU Bay Installation	16
7.2 Video Input Modules.....	16
7.3 Video Output Modules.....	17
7.4 CPU Module.....	17
7.5 Camera and Monitor Video Connections	18
7.6 Termination Practices	18
7.6.1 LTC 8500 Series Video Terminations	18
7.6.2 Monitor Output Video Connections.....	18
8. Optional Accessories Installation	19
8.1 General Accessory Installation.....	19
8.2 Logging Printer Option Installation	19
8.3 Computer Interface Installation.....	20

9. Satellite Configuration Installations	21
9.1 Satellite Site “Trunk Line” Monitor Outputs	21
9.2 Main Site “Trunk Line” Video Inputs	22
9.3 Control Data Lines in Satellite Systems	22
9.4 Satellite Site Programming Requirements	22
9.5 Main Site Programming Requirements.....	23
9.6 Special Programming for “Cascaded” Satellite System Configurations	25
9.7 Alarm Inputs in Satellite Systems	26
10. Feature Selection	27
11. Main Power Connections.....	28
12. Video Monitor Display	29
12.1 Time / Date.....	29
12.2 Monitor Title/System Status Display	29
12.2.1 Monitor Message	29
12.2.2 System Status Display	30
13. Factory Default Settings.....	33
13.1 User Selectable DIP Switch Settings for Main CPU Bay.....	33
13.1.1 Upper CPU DIP Switch S1001.....	33
13.1.2 Lower CPU DIP Switch S1002.....	34
14. User Information	38
14.1 User Priority Levels.....	38
14.2 User Priority Access Table	39
15. Alarm Information	40
15.1 General	40
15.2 Basic Alarm Response Mode	40
15.3 Auto Build Alarm Response Mode	40
15.4 Sequence and Display Alarm Response Mode	40
15.5 Alarm Activated Pre-position.....	41
15.6 Sample Alarm Responses	41
15.7 Alarm Relay Response	43
16. Keyboard Operation	44
16.1 General	44
16.2 System Commands.....	44
16.2.1 Keyboard Log-in Procedure.....	44
16.2.2 Keyboard Log-off Procedure.....	45
16.3 Switcher Commands	45
16.4 Controlling Camera Movement.....	45
16.4.1 General	45
16.4.2 Focus and Iris Lens Control.....	45
16.4.3 Lock or Unlock Control of a Camera.....	45
16.4.4 Lock or Unlock Control of a Monitor	46
16.4.5 Recording a Camera Pre-position Scene	46
16.4.6 Recalling a Camera Pre-position Scene	46
16.4.7 Activate/Deactivate Auxiliary Function	46
16.5 Alarm Commands	47
16.5.1 Arm/Disarm Individual Alarms	47
16.5.2 Arm/Disarm All Alarms.....	48

16.5.3	Arm/Disarm Monitor	48
16.5.4	Alarms Acknowledgement	48
16.6	Sequence Control	48
16.6.1	Load/Clear a Sequence	48
16.6.2	Run a Sequence	49
16.6.3	Stop a Running Sequence	49
16.6.4	Controlling Sequence Direction	49
16.7	Sequence Programming	50
16.7.1	Programming a Simple Camera Sequence	50
16.7.2	Programming a SalvoSwitching Camera Sequence	52
17.	Keyboard User Functions	53
17.1	General Information	53
17.1.1	User Function 1 - Local Keyboard Test	55
17.1.2	User Function 2 - Show Keyboard Port Number	56
17.1.3	User Function 3 - Select Keyboard Beeper ON/OFF	56
17.1.4	User Function 4 - Adjust Position of Monitor Overlay	56
17.1.5	User Function 5 - Monitor Display Brightness / Status Selection	56
17.1.6	User Function 6 - Select Monitor Display Option	56
17.1.7	User Function 7 - Set Time	57
17.1.8	User Function 8 - Set Date	57
17.1.9	User Function 9 - Set Camera ID	57
17.1.10	User Function 10 - Change USER Password	57
17.1.11	User Function 11 - Select Time / Date Format	58
17.1.12	User Function 12 - Default All Monitor Overlays	58
17.1.13	User Function 13 - Print System Configuration Tables	58
17.1.14	User Function 14 - Reserved Function	58
17.1.15	User Function 15 - System Reset	58
17.1.16	User Function 16 - Time Event Enable/Disable	58
17.1.17	User Function 17 - Set Monitor ID	58
17.1.18	User Function 18 - Print Sequence	59
17.1.19	User Function 19 - Select Alarm Response	59
17.1.20	User Function 20 - Select Printer Verbosity	59
17.1.21	User Function 21 - Designate Alarm Monitor Type	59
17.1.22	User Function 22 - Select Control Code Format	59
17.1.23	User Function 23 - Display CPU Software Version Number	60
17.1.24	User Function 24 - Set Positions on All Monitor Displays	60
17.1.25	User Function 25 - Set Brightness on All Monitor Displays	60
17.1.26	User Function 26 - Set Display Option On All Monitors	60
17.1.27	User Function 27 - Select Keyboard Log-in	60
17.1.28	User Function 28 - Select Console Log-in	61
17.1.29	User Function 29 - Reset RS-232 Parameters to Default	61
17.1.30	User Function 30 - Set Console RS-232 Parameters	61
17.1.31	User Function 31 - Set Printer RS-232 Parameters	61
17.1.32	User Function 32 - Set Alarm RS-232 Parameters	61
17.1.33	User Function 33 - Display User Number and Priority	61
17.1.34	User Function 34 - Camera Indicator	62
17.1.35	User Function 35 - Controllable Cameras	62
17.1.36	User Function 36 - Select Crosspoint Data	62
17.1.37	User Function 37 - R/D Address Mode	62
17.1.38	User Function 38 - Printer Port Mode	62
17.1.39	User Function 39 - Select DIU Interface Port	62
17.1.40	User Function 40 - Reserved Function	62
17.1.41	User Function 41 - Set Satellite Communication Format	62

17.1.42	User Function 42 - Keyboard Log-in Auto-off Mode.....	64
17.1.43	User Function 43 - CPU Battery Status	64
17.1.44	User Function 99 - User Function Index	64
18.	Maintenance Information.....	65
18.1	Cleaning the Keyboard.....	65
18.2	AC Line Voltage Input Selection	65
18.3	AC Line Fuse Replacement	66
18.4	Power Supply Fuse Replacement	66
18.5	Replacement of Memory Backup Batteries.....	66
19.	Character ROM Tables for LTC 8500.....	68
20.	Error Messages.....	70
21.	Troubleshooting Guide	73
21.1	Main Bay Checkout	73
21.2	Keyboard Checkout	73
21.3	Video Monitor Display Checkout	74
21.4	Remote Receiver/Driver Functions Inoperative.....	74
21.5	No Alarm Response	74
21.6	CPU Software Version Numbers.....	75
22.	Glossary of Terms.....	76
Appendix A	Satellite Systems	78
Appendix B	Installation Checklists	85
Appendix C	Quick Reference Cable Interconnections	86
Appendix D	Main Bay Rear Panel Connector Pin-outs and Cable Pin-out	88

1 Unpacking

This equipment should be unpacked and handled with care. If an item appears to have been damaged in shipment, notify the shipper. Verify that all parts shown in the Parts List have been included. If any items are missing, notify your Bosch Security Systems Sales or Customer Service Representative.

The original packing carton is the safest container in which to transport the unit. Save it for possible future use.

1.1 Parts List

The following table lists the components:

Qty	Item
1	LTC 8501 Series Main CPU card cage
1	LTC 8511/00 CPU module
1	LTC 8505 Series Power Supply
1	AC power cord (either for 120 VAC or 220 - 240 VAC)
1	Fuse kit
1	This installation manual

2 Service

If the unit needs repair, contact the nearest Bosch Security Systems Service Center for authorization to return and shipping instructions.

Service Centers

- **USA**
 - Phone: 800-366-2283 or 717-735-6638
 - Fax: 800-366-1329 or 717-735-6639
- **CCTV Spare Parts**
 - Phone: 800-894-5215 or 408-956-3853 or 3854
 - Fax: 408-957-3198
 - E-mail: BoschCCTVparts@ca.slr.com
- **Canada**
 - Phone: 514-738-2434
- **Europe, Middle East & Asia Pacific Region**
 - Phone: 32-1-440-0711

For additional information, see www.boschsecurity.com.

3 Description

This Allegiant video switcher/control system combines both switching and computer technology to provide powerful performance and unique system features for the security user. Offering full matrix switching capability, this system can be programmed to display the video from any camera on any monitor, either manually or via independent automatic switching sequences.

The LTC 8500 Series Allegiant system can handle up to 64 cameras and eight (8) monitors in a full crosspoint configuration. It can also accommodate 128 alarm points, up to eight (8) system keyboards, a computer system console port, and a logging printer port.

This system can be programmed with up to 60 sequences that can be run independently of each other, in either a forward or reverse direction. Any of the sequences can utilize the SalvoSwitching capability where any number of system monitors may be selected to switch as a synchronized group. Using the optional LTC 8059/00 Master Control Software (MCS) package or the LTC 8850/00 Bosch Graphical User Interface (GUI), sequences can be made to activate and deactivate automatically, based upon the time of day and the day of week.

The series supports variable speed control and full programming functions of AutoDome[®] Series dome cameras. In addition, support for on-site receiver/driver units provide operators with control of pan, tilt, zoom, multiple pre-positions, four auxiliaries, autopan, and random scan using conventional camera/lens/housings.

With the addition of an external LTC 8540/00 Alarm Interface unit, an external contact closure or logic level can be used to automatically display any camera. Any monitor or group of monitors can be set to display cameras under alarm conditions. The base system contains three (3) built-in alarm response modes: basic, auto-build, and sequence and display. In addition to these three (3) modes, the PC based software packages offer the ability to combine any or all three (3) standard modes. Alarm video may be selected to reset either manually or automatically. In addition, a 16-character alarm title can be selected to appear instead of the camera title during alarm conditions.

System operation and programming is accomplished using a full-function, ergonomically designed keyboard. Multiple keyboards may be used in the system. Built-in operator priority levels and the ability to restrict certain operators from controlling designated functions provide maximum flexibility.

This system includes a 48-character on-screen display for time-date, camera number, camera ID (16 characters), and monitor (12 characters) or status information. When programming camera ID and monitor titles, 256 different characters are available.

Enhanced programming and switching features can be obtained by utilizing a standard Windows[®] equipped PC and the optional LTC 8059/00 MCS package or the LTC 8850/00 GUI Software. A user friendly spreadsheet format provides the ability to enter camera titles, enter operator names, schedule up to 64 timed events, change system parameters, program camera sequences, install lockouts, and access the advanced alarm handling screens with speed and efficiency. The programmed information may then be transferred into the Allegiant system, stored on disk, or printed from a PC.

The LTC 8850/00 Bosch GUI Software is designed around an intuitive graphic-based interface. This software provides high performance programming, control,

and monitoring of all system functions by using on-screen icons to reflect real time status of the devices controlled by the system.

The LTC 8850/00 GUI Software also provides the ability to monitor system status events. System alarms, switching functions, sequence events, and keyboard actions can be viewed in real time on the PC screen and, if desired, logged to the PC hard drive. The LTC 8850/00 GUI Software can also be used to enable a special on-screen icon for identifying controllable cameras.

The CPU inside these matrix switchers supports powerful macro capabilities. The macros can be activated using system keyboards, system time event functions, alarm activations, and via special function icons in the LTC 8850/00 GUI Software.

This system can serve as the master switcher in a SatelliteSwitch configuration. This innovative feature enables a single master Allegiant system to communicate with remotely located "Satellite" systems. Any Allegiant system model can serve as a remote Satellite switcher. This powerful feature permits the design of a distributed matrix video switching system with control at one central location and individual control at the local sites. The main control site can view/control local cameras plus cameras located at any of the remotely distributed Satellite sites. The Satellite sites can view/control only cameras associated with their own site. When these models are used in this type of configuration, the main system can access up to 256 cameras located anywhere in the system.

4 Allegiant Feature Summary Table

This Allegiant Series system is available in two (2) operating configurations: a base system and the base system with an optional PC based software package. The base system includes features required for most switching/controller systems.

The addition of the optional LTC 8059/00 MCS or optional LTC 8850/00 GUI Software package enables the user to customize the system's configuration using a menu driven program run on any personal computer using Microsoft® Windows 98 SE, Windows ME, Windows NT®, Windows 2000, or Windows XP.

The following table lists available features.

Feature	Base System	With Optional Allegiant PC-Based Software
1. Full camera switching/control on all monitors	Y	Y
2. Up to eight (8) system keyboards	Y	Y
3. Up to 64 alarm inputs	Y	Y
4. Three (3) user-selectable pre-defined alarm response modes	Y	Y
5. Full control of on-site receiver/drivers	Y	Y
6. SalvoSwitching feature	Y	Y
7. 60 Programmable sequences	Y	Y
8. Alarm call-up of pre-position scenes	Y	Y
9. RS-232 Interface ports for computer, logging printer, etc.	Y	Y
10. Keyboard log-on/log-off function	Y	Y
11. User-selectable password security	Y	Y
12. 16-Character camera titles and 12-character monitor titles	Y	Y
13. Format selection time/date format	Y	Y
14. Local keyboard test function	Y	Y
15. Table and Sequence printout feature	Y	Y
16. Parameter designation for RS-232 communication	Y	Y
17. Satellite configurations	N	Y
18. Restrict user/keyboard access to cameras	N	Y
19. Restrict user/keyboard access to receiver/drivers	N	Y
20. Restrict user access to keyboard	N	Y
21. Restrict user/keyboard access to monitors	N	Y
22. Designate user name and ID number	N	Y
23. Designate zoned alarm call-ups	N	Y
24. Powerful alarm response features	N	Y
25. Designate displayed camera number	N	Y
26. Designate receiver/driver functions on alarm	N	Y
27. Program 64 time activated events	N	Y
28. Designate receiver/driver functions in sequences	N	Y
29. Broadcast monitor messages	N	Y
30. Alarm title designation	N	Y
31. Personal computer displayed monitoring of system status	N	Y

In addition, this system provides the capability to control on-site receiver/driver units and the AutoDome Series of integral pan/tilt/zoom/cameras.

The LTC 8500 Series system contains a logging printer output port, so an inexpensive RS-232 serial printer or some other form of logging software can be used to capture log data. This provides a permanent record showing time and date of changes to system status, such as:

- Incoming alarms
- Acknowledgment of alarms by users
- Loading sequences
- User log-on to keyboard or console port
- Console broadcast message
- Console transfer of system tables
- Activation of time event functions
- Power up reset message

The printer may also be used to provide a hard copy of all system configuration Tables and Sequences.

5 System Components

5.1 LTC 8501 Series Systems

- **LTC 8501 Series Main CPU Bay**

A modular equipment bay which contains the system's microprocessor module (LTC 8511/00), the power supply module (LTC 8505 Series), and combinations of video input and video output modules (see below).

- **LTC 8521/00 Video Input Module**

Individual cards placed in LTC 8501 Series bays to accept inputs from cameras and other video sources. Each card provides eight (8) video input channels with switch selectable terminations.

- **LTC 8532/00 Video Output Modules**

Individual cards placed in LTC 8501 Series bays to provide video outputs to monitors and DVRs. Each card provides two (2) video output channels.

- **LTC 8501 Series System Capacities**

Up to eight (8) video input modules; eight (8) inputs per module.

Up to four (4) video output modules; two (2) outputs per module.

Total: 64 inputs and eight (8) outputs.

Satellite configuration input capacity: 320.

6 System Accessory Components

The Allegiant Series accessory products provide many optional features to the base system. A brief description of accessory products is provided below. Complete specification information can be found in respective product data sheets. Applicable accessories are designed to be compatible throughout the Allegiant Series.

6.1 LTC 8540/00 Alarm Interface Unit

The LTC 8540/00 is an alarm gathering unit which accepts up to 64 dry contact closures or logic level inputs from remote sensing devices such as door contacts, PIRs, etc. and then reports this alarm information to the main CPU bay. Alarm inputs may be configured in groups of 32 to accept either normally open or normally closed contacts. This unit provides eight (8) relay outputs which can be used to drive external alerting devices, DVR's, and other devices.

6.2 LTC 8568 and LTC 8768 Signal Distribution Units

The signal distribution is a main site control code distribution and line driver units are available for communicating to receiver/drivers, switcher followers, and Allegiant Satellite systems. The LTC 8568/00 Signal Distribution Unit provides 32 separate outputs for driving up to 256 remote devices. Either "star" or "daisy chain" wiring configurations may be used. The LTC 8768/00 Signal Distribution unit is similar to the LTC 8568/00, except that it provides 64 separate outputs for driving up to 512 remote devices.

6.3 IntuiKey Series KBD-Universal Keyboard

The IntuiKey KBD-UNIVERSAL is a full function keyboard used for control and programming of the Allegiant Series matrix switchers. Backlit LCD screens provide a multi-language display of softkey menus and status information. Integral variable speed joystick and zoom lens controls are standard for operating fixed or variable speed pan/tilt/zoom equipped cameras. Both Allegiant RS-485 and Allegiant RS-232 keyboard protocols are supported.

In addition to the Allegiant Series, the KBD-UNIVERSAL model IntuiKey can be used to simultaneously control Divar Series DVRs, System4 Series multiplexers, and access ADIM based DVR control screens.

6.4 KBD-Rack Keyboard Mounting Kit

Rack-mounting kit designed to provide vertical, horizontal, or inclined mounting for IntuiKey keyboards.

6.5 LTC 8555 Series Keyboards

The LTC 8555 Series keyboards are compact, full function keyboards for use with Allegiant Series matrix switchers. LED readouts display real time system status information. Includes variable speed joystick and zoom lens controls for operating fixed or variable speed pan/tilt/zoom equipped cameras. The keyboards are available in the following configurations:

Model Number	Top Bezel Graphics	Communication Protocol
LTC 8555/00	English	RS-485
LTC 8555/01	Icons	RS-485
LTC 8555/02	English	RS-232
LTC 8555/03	Icons	RS-232

The RS-232 model keyboards connect to an Allegiant's console port or to a port provided by an LTC 8712 Console Expander accessory unit. Up to four (4) may be connected to a single LTC 8712 unit. When used with dial-up type phone modems, these keyboards provide rudimentary dialing capability.

6.6 LTC 8558/00 Keyboard Extension Cable

The LTC 8558/00 keyboard extension cable has a six-conductor extension cable that carries data/power for remote keyboards up to 30 m (100 ft) away from the main CPU bay.

6.7 LTC 8557 Series Keyboard Extension Kits

The LTC 8557 Series keyboard extension cable is an interface kit used to remote the IntuiKey Series or LTC 8555 Series keyboards up to 1.5 km (5000 ft) away from the main CPU bay. Customer supplied 0.5 mm² (24 AWG) shielded-twisted pair (Belden 9841 or equivalent) required between the main CPU bay site and keyboard site. Kit provides two (2) junction boxes, interface cable, and appropriate keyboard power supply.

6.8 LTC 8560 and LTC 8561 Series Receiver/Driver Units

These series of on-site receiver/drivers are designed to receive biphasic control code and convert this data into signals for controlling conventional pan/tilt, zoom lenses, and auxiliary functions. Supplied in an environmentally rated enclosure, these series of receiver/drivers are available in both basic and full-featured models. This unit contains integral local test feature, autopan or random scanning, and is available in several input and output drive voltage versions.

6.9 AutoDome Series

The AutoDome Series comprise an integral camera, a high speed pan/tilt mechanism, a zoom lens, and a receiver/driver system in a compact dome enclosure. Various enclosure mounting options are available for indoor and outdoor applications.

6.10 LTC 8569, LTC 8570, LTC 8571, LTC 8572 Series Code Merger Units

These series are control code merger and line driver units used to combine Allegiant biphasic control code from two (up to four with LTC 8570 and LTC 8572 versions) systems for communicating to AutoDome Series cameras, receiver/drivers, switcher/followers, and Allegiant Satellite systems.

The LTC 8569, LTC 8570 Series provides 32 separate outputs capable of driving up to 256 remote devices. The LTC 8571, LTC 8572 Series provides 64 separate outputs capable of driving up to 512 remote devices. Either “star” or “daisy chain” wiring configurations may be used. The unit will accept signal input either from an Allegiant main CPU bay, LTC 8568/00 output, LTC 8780 biphasic output, or an output from another LTC 8569, LTC 8570 Series or LTC 8571, LTC 8572 Series unit. Multiple units may be cascaded to obtain additional outputs.

6.11 LTC 8770 Switcher Follower Series

The LTC 8770 Series is an accessory unit which provides relay contact closures corresponding to cameras displayed on system monitors. The LTC 8770 may be configured to follow manual activations, non-alarmed video, alarmed video, or both. Each unit provides 24 relay contact outputs. In addition, six (6) functional operating modes are available, including one user activated test mode.

6.12 LTC 8712 Series Console Port Expander Units

The LTC 8712 Series “expands” an Allegiant system's console port to permit up to four (4) external computing devices to communicate with the system via RS-232 protocol. Any computing device that can normally communicate directly with an Allegiant via its RS-232 console port can be used with this port expander. The external devices may consist of PCs running the Allegiant system's MCS package, the Allegiant GUI, access control systems, Allegiant RS-232 protocol keyboards, or other devices utilizing the Allegiant system's Command Console Language (CCL).

6.13 LTC 8713 Alarm Port Expander Units

The LTC 8713 Series interfaces to the alarm port of an Allegiant system to permit additional LTC 8540/00 Alarm Interface units to be connected. In a LTC 8500 system, two (2) LTC 8540/00 units can be connected to a LTC 8713 Series unit providing up to 128 alarm inputs. In LTC 8600 systems, up to eight (8) LTC 8540 Series units can be connected to three (3) LTC 8713 Series unit providing up to 512 alarm inputs. In LTC 8800 systems, up to sixteen LTC 8540 Series units can be connected to five (5) LTC 8713 Series unit providing up to 1024 alarm inputs.

6.14 LTC 8780 Series Data Converter Units

The LTC 8780 Series are accessory units that convert the Allegiant system's biphasic control code into RS-232, or converts RS-232 back to biphasic code. This provides the capability of transmitting the control code over conventional RS-232 transmission mediums such as phone modems, fiber optics, microwaves, etc. The unit will accept the Biphasic control code generated by an Allegiant main CPU bay, an LTC 8568/00 Signal Distribution unit, or an output from an LTC 8569, an LTC 8570, an LTC 8571, or an LTC 8572 Series Code Merger unit.

6.15 LTC 8781 Series Data Converter Units

The LTC 8781 Series are accessory units that decode the Allegiant system's encoded time/date information generated on the biphasic control code line and convert it into an RS-422 GPS format. This time/date information can be used to interface into external time/date inserter products (such as the Kalatel KTS-53-16), which are designed to be synchronized via a GPS signal.

6.16 LTC 8016/90 Bilinx™ Data Interface Unit

The LTC 8016/90 Allegiant Bilinx Data Interface unit is an accessory used for communicating over-the-coax, with up to 16 Bilinx-capable AutoDome and/or Dinion™ Series cameras. The LTC 8016 provides complete control of pan/tilt/zoom, auxiliaries, and pre-position functions of Bilinx enabled AutoDome Series cameras. In addition, complete programming of Dinion Series cameras and AutoDomes via their on-screen menus is supported. Bilinx technology also supports camera-generated event reporting to the Allegiant. This connection allows remote alarm inputs and motion event data to be sent by the camera to the Allegiant without the need for additional wiring between the camera site and the main control location. The LTC 8016 can also be used to transmit Bilinx communications over a number of video transmission systems. Example devices include fiber optic links and external balun devices that use CAT5 twisted pair cables for video communication.

6.17 LTC 8785 Series Code Converters

The LTC 8785 Series code converter units are designed for use in older Allegiant systems that have been upgraded to support 'variable speed' control code protocol. The LTC 8785 units are used to provide a source of 'fixed speed' control code when the system is generating the newer 'variable speed' control code preferred by the AutoDome Series of PTZ cameras. The LTC 8785 would receive the variable speed control code from the Allegiant via its LTC 8568/00 Signal Distribution unit and convert it into the appropriate fixed speed control code. The 'fixed speed' control code outputs from the LTC 8785 Series connect to the older TC8561 Series receiver/drivers using the existing field cabling.

6.18 LTC 8782 Series Code Translator Units

The LTC 8782 Series Code Translators are accessory units that convert biphasic code to other manufacturers' control codes, or convert other manufacturers' codes to

biphase. Many of the most popular protocol codes are supported, including Pelco[®], Vicon[®], American Dynamics[®], Sensormatic[®], Kalatel[®], Diamond Electronics[®], and Javelin[®]. Fixed and variable speed codes are supported where applicable.

6.19 LTC 8059/00 Master Control Software

The Allegiant LTC 8059/00 MCS brings the familiarity of the personal computer to those who supervise closed circuit television systems. Running on a Windows based compatible computer, this software is the human interface that makes it quick and easy to configure an entire Allegiant system.

With the MCS package, users can set and change an Allegiant's system parameters; program camera sequences; lock cameras, monitors, remotes, and keyboards from certain users; and perform many other system control features. Users can also view system activity with real time monitoring of the system status, and if desired, log this information to a file stored on the hard drive.

6.20 LTC 8850/00 Windows Based Graphical User Interface Software

The Allegiant LTC 8850/00 GUI Software is a PC-based program designed for complete control and programming of the Allegiant Series of matrix switchers. With a mouse click on an icon, operators can easily take control of system hardware devices, including cameras, monitors, and alarms. Jumping from one map to another is easily accomplished using special link icons. System Administrators can easily call-up the included Allegiant LTC 8059/00 MCS module for entering the Allegiant system's camera titles, sequences, alarm responses, and many other configuration features. Communication between the GUI workstations and an Allegiant system can be made using an RS-232 link, or via a Windows based-PC network.

6.21 SFT-INTSRV Allegiant Integration Software

The SFT-INTSRV software CD contains three (3) distinct software packages that can be used to integrate external devices with an Allegiant system matrix switcher. Please refer to the following sections for details:

Integration Server

The Integration Server is a versatile software package used to integrate multiple systems that are not ordinarily compatible with each other. This system can include video switchers, point of sale systems, fire/burglar alarms, Access Control, or HVAC systems. Devices can be interfaced using any of the following three (3) methods: serial RS-232 connection, digital I/O card, or directly to an Allegiant Switcher via the LTC 8059 MCS program. The Integration Server software is programmed to recognize events as they occur in real time from one or more systems, based upon one of the three (3) integration methods mentioned above. It then reacts to those events by sending commands to another system or systems.

Virtual Allegiant Satellite Application Software

The Virtual Allegiant Satellite Application (VASA) is Bosch's strategic product that allows existing Allegiant customers to transition gradually to pure IP technologies rather than a total and instantaneous replacement. VASA acts as the integration

bridge between an existing Allegiant and the new digital based CCTV system (the 'satellite') that uses digital video encoders and decoders. With VASA, the new IP technology is totally transparent to the existing Allegiant users who continue to use their Intuikey CCTV keyboards for video switching and PTZ control on classic analog monitors.

VASA supports the Allegiant LTC 8100 through the LTC 8900 Series matrix switchers. In addition to PTZ control, VASA provides auxiliary and preposition control of the IP-based cameras. VASA improves the ROI on existing capital assets, removes the need for training, and reduces the risk for adopting new technology by incrementally adding to the system. The integration is seamless and the transition is designed to be imperceptible.

Allegiant Satellite Software Development Kit

The Allegiant Satellite Software Development Kit (SDK) is a fully supported set of libraries, documentation, and samples targeted at PC-based application software that is used to control 3rd party CCTV matrix systems or manage IP-based digital video networks. Since the SDK can be used to create customized solutions for unique, specific problems, customers looking to integrate an Allegiant matrix system with products offered by other manufacturers is readily accomplished. For the thousands of existing Allegiant customers, it also provides a bridge to integrate or expand their systems with IP based products gradually rather than a total and instantaneous replacement.

When operating in an Allegiant satellite system configuration, an Allegiant master generates switching and PTZ data that is typically used to control a remote Allegiant satellite matrix. Using the SDK, the video switching commands and PTZ data from the master system are converted into an ActiveX interface allowing developers to easily translate this information into formats used to control other original equipment manufacturer's (OEM) systems. The SDK also supports an ability to translate repetitive type Allegiant PTZ commands to their indefinite equivalents, resulting in reduced interface traffic and lower bandwidth demands when controlling IP based networks.

The level of integration available with the SDK results in a robust interface that provides transparent operation to the existing Allegiant operators. Operators continue to use their existing CCTV keyboards for selecting video and control of PTZ devices on the Allegiant monitors. This type of solution improves the return of investment on existing capital assets, removes the need for training, and reduces the risk for adopting new technology by incrementally adding to the system.

The SDK is compatible with all models of the Allegiant Series switchers. In addition to video switching commands and PTZ control, auxiliaries and prepositions are also supported. The SDK is supplied with five sample applications. Three (3) applications use C++ to demonstrate incorporating the SDK in a console, an ATL, and an MFC application. In addition, samples using Visual Basic[®], and Microsoft's .NET Framework are included.

6.22 LTC 8506/00 PC-to-Console Port RS-232 Cable

The LTC 8506/00 is an RS-232 grade cable with 9-pin D-connectors on each end that is used to connect an Allegiant's system's console port to a standard PC COM port. This cable is included in the Allegiant LTC 8059 MCS and the LTC 8850 Allegiant GUI packages. Length is approximately 3 m (10 ft).

6.23 Logging Printer

An optional RS-232 serial printer may be connected to this system to provide a permanent record of significant system status changes. Time and date is printed for system events such as alarms, start-up after power failure, sequence loading, operator log-on/log-off to keyboards, and download of information from the optional MCS. The printer may also be used to obtain hard copies of all system tables and sequences.

NOTE The printer port does not provide a standardized pin-out connection. If desired, a cable can be made up at installation, by following the cable pin-out information provided at the end of this manual.

LTC 8500 Series Video Switching Configuration

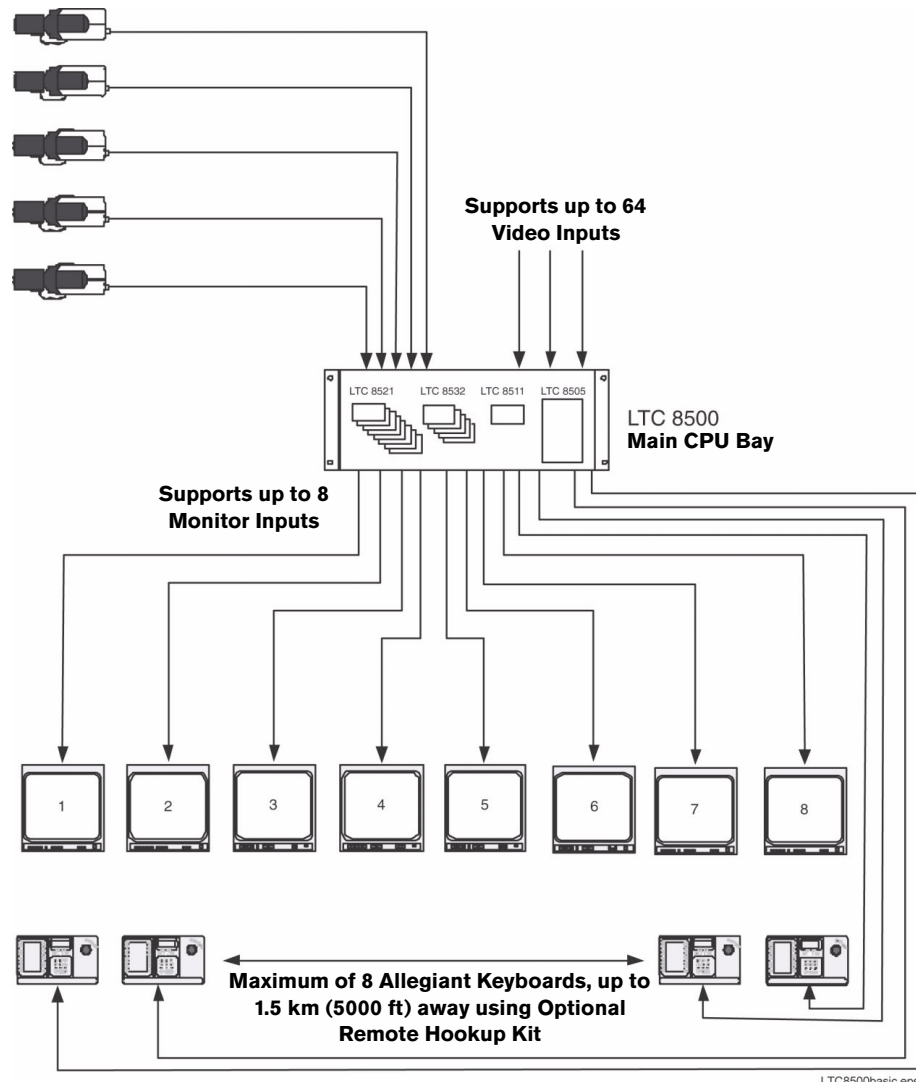

Figure 1: LTC 8500 Series Basic Video Switching Configuration

LTC 8500 Series Full Capacity Video Switching Configuration

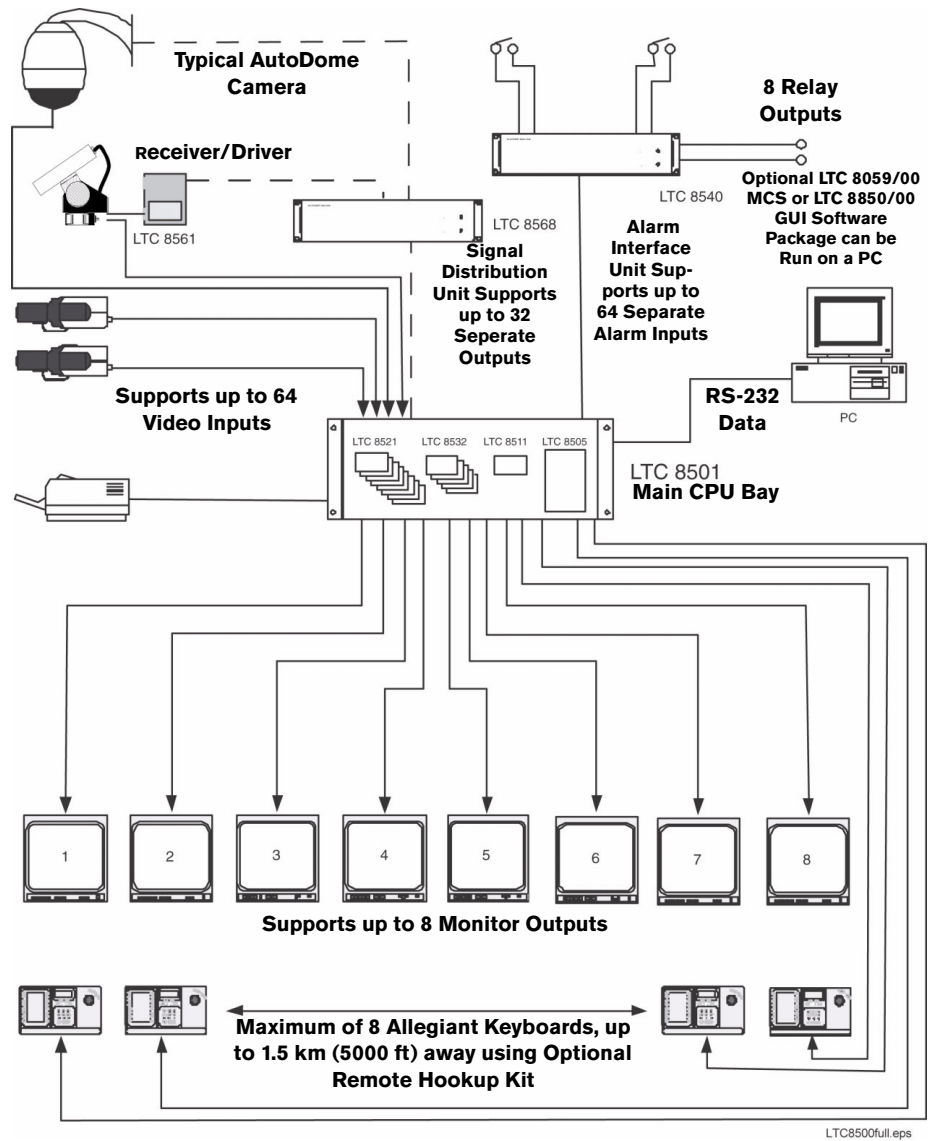

Figure 2: LTC 8500 Series Full Capacity Video Switching Configuration

7 Installation Procedure

7.1 Main CPU Bay Installation

Before discarding the shipping cartons, verify that the various pieces of equipment have no evidence of carrier damage.

CAUTION Do not apply power to the equipment until instructed to do so.

1. Remove the front panel of the main CPU bay by loosening the four (4) corner fasteners.
2. Install the power supply in far right position of the main CPU bay insuring proper alignment and seating of the module into the rear mating connector. Verify that the power supply ON/OFF switch is in the OFF position.
3. Install the four (4) screws and star washers (supplied) on the rear panel of the bay(s) surrounding the power supply line cord to fasten the power supply securely in place.

CAUTION If the Allegiant card cage is to be transported, the main power supply should be removed to prevent possible damage to the bay's internal parts.

4. If the bay(s) are to be installed into a standard 19-inch EIA rack, remove the four (4) rubber bumper foot pads found on the bottom of the bay before installing the unit in the rack. Four (4) holes are provided for mounting the bay(s) in the rack.

7.2 Video Input Modules

Termination switches on the Video Input Modules (VIM) must be set to the correct position prior to installation. If necessary, see Section 7.6 "Termination Practices," on page 18 prior to actually installing the VIM on this system.

The appropriate number of VIMs should be installed in the main bay starting with the left most slot. If less than full capacity is being used, the modules should be inserted in a left-to-right manner so that the lower camera numbers are used first.

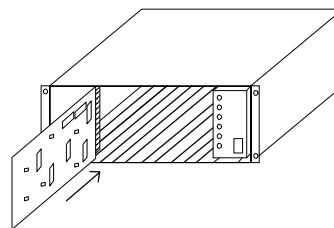

Figure 3: Typical Video Input Module Insertion

The VIMs are identical and are interchangeable within the designated VIM slots without having to make any changes to the module.

7.3 Video Output Modules

Counting from left to right beginning with slot 9, install the appropriate number of Video Output Modules (VOM) into these slots. If fewer than the maximum number of VIMs are installed, there will be empty slots between the Input and the Output Modules, so make sure that the Output Modules are inserted into the correct slots.

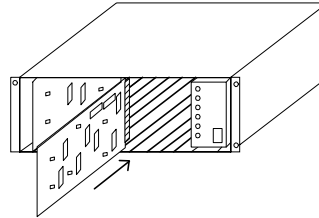

Figure 4: Typical Video Output Module Insertion

All VOMs are identical and are interchangeable within the designated VOM slots.

7.4 CPU Module

The slot to the left of the power supply in the main CPU bay is reserved for the system CPU module.

NOTE The CPU module contains two (2) lithium batteries mounted on the component side of the printed circuit board. A red rectangular insulating tag may be installed in between the top of the batteries and the battery holder clip. This tag prevents battery drainage during stocking. Remove tag if so equipped.

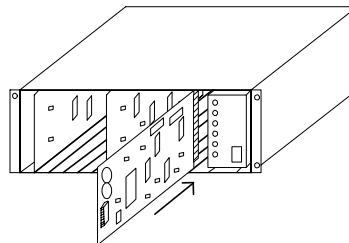

Figure 5: Typical CPU Module Insertion

Install the main bay CPU at this time.

The circuit board contains two (2) 8-position DIP switches for system configuration options. The DIP switches can be used to modify certain system operating conditions. Review the Factory Default Settings Section to determine if it is necessary to change the DIP switches from the factory default positions. For reference, the factory default settings are:

DIP Switch S1001	All OFF
DIP Switch S1002	Switch 5 ON, 7 ON, and 8 ON; All others OFF

7.5 Camera and Monitor Video Connections

Refer to Figure 10 on page 28 for the next series of steps.

Connect the system cameras to the appropriate video inputs, but as a minimum connect one known operating camera to video input #1 on the rear of the main CPU bay. Use only those inputs that correspond to an installed VIM. Also connect desired monitors to the rear of the main CPU bay, ensuring to connect at least one monitor to video output #1. The video outputs are the left-most column of BNC connectors on the rear of the bay. Use only those outputs that correspond to an installed VOM.

7.6 Termination Practices

Video from every video input signal must be “terminated” with a 75 ohm resistance. Each video line should be terminated exactly once. If video from a given camera is going to several different devices, only the last piece of equipment on the video line should be terminated. The following sections detail the ways that various Allegiant systems terminate video inputs.

LTC 8500 Series Video Terminations

Each LTC 8521/00 VIM card has an 8-position DIP switch for selecting the termination of each individual video line. To terminate an input line, make sure that the appropriate DIP switch on the VIM card is ON. If non-terminated operation is required for looping purposes, turn the switch OFF (Switch 1 corresponds to the first video input channel of the card).

The LTC 8500 Series main bays do not directly support video input looping connections. To attach video signals to inputs that will be looped on this system, a short piece of coax connected to a BNC "T" connector that has three (3) female ends is required.

Monitor Output Video Connections

Identical to camera inputs, monitor outputs on the Allegiant system are designed to be terminated. Each monitor output expects to be connected to a 75 ohm load. This is the regular load typically provided by a normal monitor. If a monitor output line is "looped" through several monitors or other equipment, the system installer should make sure that only the last unit on the line is terminated.

8 Optional Accessories Installation

8.1 General Accessory Installation

There are many accessory products available for the Allegiant Series, including keyboards, alarm interface units, control code signal distribution units, etc. If applicable, these products can be installed at the same time as the main CPU bay installation, or postponed until later. In some cases, products are designed to be racked in close proximity to the main CPU bay, so appropriate rack space should be reserved.

Please refer to the instructions supplied with the specific accessory product for complete installation details.

8.2 Logging Printer Option Installation

NOTE Although the exact installation procedure for each printer varies, the following steps are generally required. Be sure to save the printer reference manual for procedures not covered.

1. Switch the main power OFF to the printer.
2. Install the ribbon cartridge and paper if necessary.
3. Set any configuration switches for your particular printer to match the format provided by the Allegiant system. Note that the system communication protocol can be changed using the Keyboard User Functions (described later in this manual) with the optional Allegiant LTC 8059 MCS package. The factory default values are as follows:

Baud rate --	19,200
Stop bits --	1
Data bits --	8
Parity --	None

NOTE The required interconnect cable utilizes a custom pinout. Refer to the Appendix Section of this manual for wiring details.

4. Attach the 25-pin male D-type connector side of the RS-232 cable to the connector on the printer.
5. Attach the 9-pin male connector side of the cable to the Allegiant CPU bay connector marked "PRINTER".
6. Apply power to the printer.
7. Verify logging printer action by 'loading' a previously stored sequence into a monitor, activating an alarm, or performing a system reset. Any of these actions should cause printouts to occur.

8.3 Computer Interface Installation

NOTE Although the exact installation procedure for each computer varies, the following steps are generally required. Be sure to save the computer reference manual for procedures not covered here. Switch the main power OFF to the computer.

1. If using an Allegiant software package, attach the PC security key provided with the software to an available port on the computer.

The supplied interconnect cable utilizes a custom pinout. If it ever becomes necessary to replace the cable, it can be ordered separately using part number: LTC 8506/00. Alternatively, a cable can be configured using the information found in the Appendix Section of this manual.

2. Attach one end of the supplied RS-232 interface cable to the main Allegiant CPU bay connector marked Console (or another port that has been configured to operate as a console port).
3. Attach the other end of the cable to an available serial port (COMM PORT 1 or COMM PORT 2) on the rear of the computer.
4. Apply power to the computer and allow it to boot up its operating system before inserting the software disc.
5. Refer to the applicable Allegiant software manual for complete programming instructions.

9 Satellite Configuration Installations

Due to the many variations possible, only general guidelines can be covered for installing satellite systems. Refer to the Appendix Section of this manual, the LTC 8850/00 GUI Software manual, or the LTC 8059/00 MCS package manual for additional configuration and programming information on satellite systems.

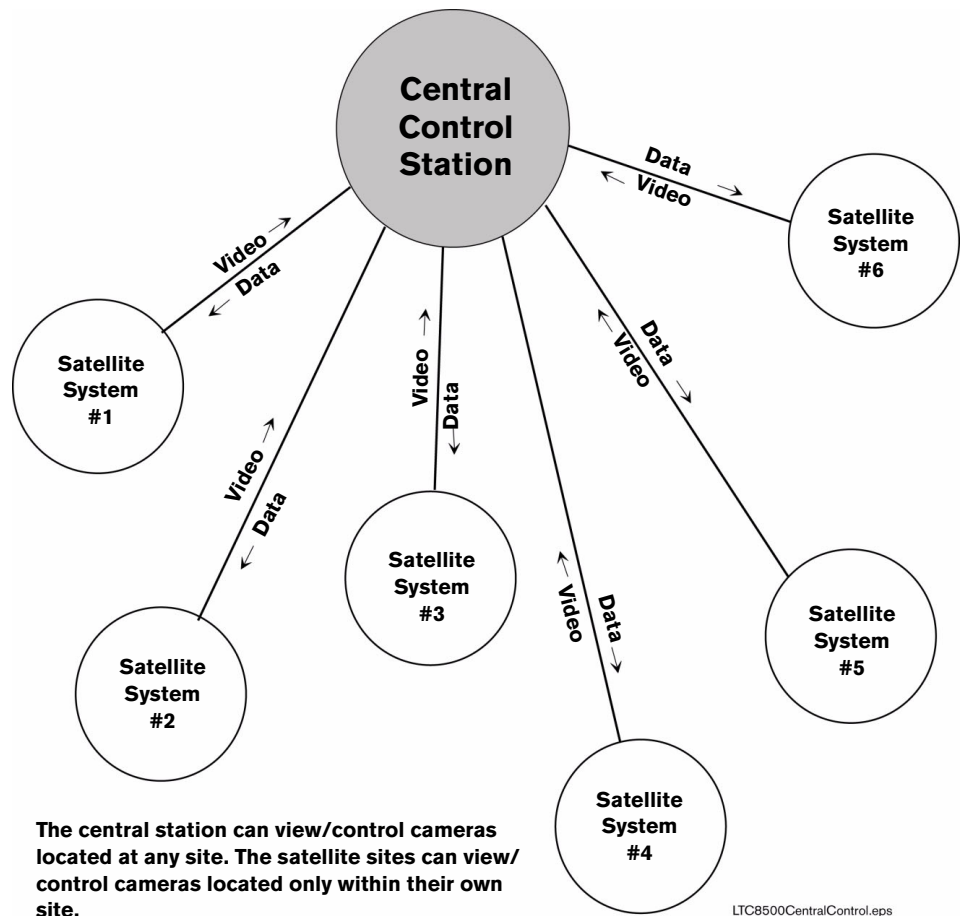

Figure 6: Satellite Concept Configuration

9.1 Satellite Site “Trunk Line” Monitor Outputs

At each of the remote satellite sites, a desired number of monitor outputs from the switcher must be assigned as trunk lines. The number of trunk lines can range from 1 to the maximum number of monitor outputs provided by the switcher. Note that the number of trunk lines coming from a satellite site determines the maximum number of cameras from that site which may be viewed simultaneously at the main site. If operators will be stationed at the satellite site, they should be prevented from accessing the monitor outputs designated as trunk lines. This prevention can be accomplished via the Monitor Lockout Tables in either the LTC 8059/00 MCS or the LTC 8850/00 GUI Software (see below).

9.2 Main Site “Trunk Line” Video Inputs

At the main site, video trunk line connections coming from each of the remote site(s) should be connected (and properly terminated) using an available video input at the main bay. There are no programming restrictions concerning their connections, but a sense of order can be maintained if a group of video inputs are used at the upper end of the system’s designed capacity. This technique allows the main system to be more easily expanded in the future with additional local cameras or trunk lines. As an example, assume there are a total of eight trunk lines coming from all satellite sites which are connected to a main site system designed for 32 inputs. Inputs 25 to 32 can be reserved for the trunk lines, leaving inputs 1 to 24 for local camera connections. If there will be no local camera inputs, the trunk lines can start at the first video input.

9.3 Control Data Lines in Satellite Systems

Each satellite site must be provided with an Allegiant biphasic control data line coming from the Signal Distribution located at the main site. This data line carries all pan/tilt/zoom control commands, in addition to the switching commands generated by the main site switcher. The control data line should be connected to a LTC 8780 Series Data Converter unit, which provides address decoding functions for the satellite site. An LTC 8780 Series is required for each satellite site, and must be given a unique site address number. If operators stationed at the satellite site are permitted to control pan/tilt/zoom-equipped cameras, an LTC 8569 Series Code Merger unit must be installed at the satellite site. In order for each site to have control over pan/tilt/zoom-equipped cameras, the Code Merger combines code generated by the main and satellite sites. The LTC 8780 Series can then be connected to one of the data outputs of the LTC 8569 Series unit.

9.4 Satellite Site Programming Requirements

The optional LTC 8059/00 MCS or the optional LTC 8850/00 GUI Software is required to properly program a satellite system.

Programming the satellite sites is usually limited to designating their logical camera numbers to appropriate values via the Camera ID Table of the MCS or GUI Software. Note that no duplicate logical camera numbers are permitted anywhere in the system. Allegiant logical camera designations can be renumbered to any four-digit number on all Allegiant Series systems, except the LTC 8500 Series, which is limited to three (3) digits. Few other restrictions exist. These camera numbers are the numbers entered at both the satellite and the main site keyboards when camera selections are made. On any AutoDome Series camera or conventional pan/tilt/zoom-equipped camera, this logical number must also be entered as the receiver/driver's site address number.

The screenshot shows a window titled "Bosch Master Control Software For Windows - [Sat_Sample.alg]". The window has a menu bar with "File", "Edit", "Transfer", "On-Line", "Window", and "Help". Below the menu bar is a toolbar with various icons. The main area contains a tabbed interface with tabs for "Camera", "Monitor", "Alarm", "User", "Sequence", "Lockout", "Time Event", "Keyboard", "Parameter", "Command Script", and "Bilink Actions". The "Camera" tab is active, displaying a table with the following data:

Input	Camera Number	Camera Title	Installation	Bay Number	Monitor Number	Controllable
1	51	Main Entrance	Local			<input type="checkbox"/>
2	52	Lobby	Local			<input type="checkbox"/>
3	53	Hall 1	Local			<input type="checkbox"/>
4	54	Hall 2	Local			<input type="checkbox"/>
5	55	Loading Dock	Local			<input type="checkbox"/>
6	56	Parking Lot 1	Local			<input type="checkbox"/>
7	57	Parking Lot 2	Local			<input type="checkbox"/>

Figure 7: Satellite Site Sample Program Showing Logical Camera Numbers and Titles

To maintain a sense of order, it is preferable to program a satellite for a range of camera numbers. For example, in a three (3) Allegiant type satellite system, the first satellite can be programmed for camera numbers 51 to 100. Satellite two can be programmed for camera numbers 101 to 131, and satellite three can use numbers 151 to 185.

If necessary, the Keyboard-to-Monitor Lockout Table in the LTC 8059/00 MCS or the LTC 8850/00 GUI Software can be programmed in the satellite switcher to prevent any local operators from inadvertently accessing the satellite's monitor outputs being used as trunk lines.

If operators will be stationed at the satellite site, camera titles should be entered into the switcher. If desired, these titles can be selected (explained below) to appear at the main site.

The only other requirement is to ensure that the console ports of all Allegiant type satellites have been set to the correct baud rate and the handshake option is disabled (CTS = off). This is done via a system keyboard (see Keyboard User Function 30), the Parameters-System screen of the LTC 8059/00 MCS or the LTC 8850/00 GUI Software (make sure the CPU dip switch S1002-8 is set to the ON position).

9.5 Main Site Programming Requirements

At the main site, the Camera ID Table must be programmed to ensure proper satellite operation. It is easiest to start with the trunk line inputs. For each trunk line, the satellite's monitor output number and its bay address must be entered (same number as the satellite's LTC 8780 address).

Camera numbers should be programmed next. No duplicate logical camera numbers are allowed anywhere in the entire system. If the system will include many local cameras, it is recommended to designate remote cameras (i.e., those located at satellite sites) using numbers above the main bay's physical video inputs (9+ on LTC 8100 Series, 17+ on LTC 8200 Series, 33+ on LTC 8300 Series, 65+ on LTC 8500, 129+ on LTC 8600, 257+ on LTC 8800 Series, 4097+ on LTC 8900 Series). Enter the desired camera number, (the satellite bay that it is actually connected to), and select if either a local title will be used, or if the remotely generated title will be used.

For satellite camera entries, only those numbers representing actual cameras need to be entered. For example, all 16 cameras associated with a LTC 8200 switcher do not need to be entered if only five cameras are actually connected to the switcher. If

desired, a few extra camera number lines in the table may be reserved at this time for future expansion. If a local title is specified, the camera's title can also be entered at this time. Designate any local camera numbers appropriately, and enter their corresponding titles.

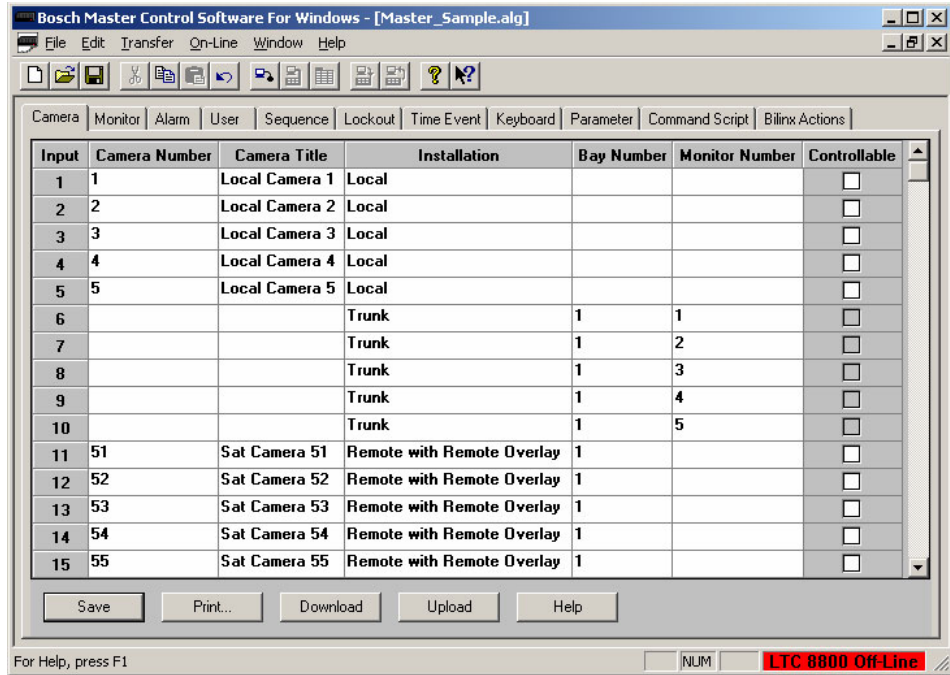

Figure 8: Main Site Sample Program Showing Local Cameras, Trunk Lines and Remote Cameras

NOTE Either a local camera, or a remote camera programmed with a local title, will need to be selected to view certain on-screen prompts or data during programming of the main site via a system keyboard.

Once the system is programmed and configured, any unused monitor outputs located at the main site should be selected to display a local camera via the system keyboard. This prevents unused monitor outputs from using up trunk lines which may result in some confusing operational responses.

The “Start-up” camera numbers listed in the Monitor Table of the LTC 8059/00 software should be programmed to specify locally connected cameras or a local unused input (i.e., the raster generator will be displayed when called up). This table defines the camera numbers that will automatically be switched to an operator's monitor in the event the trunk line being used to display their original satellite camera is 'stolen' by an operator with a higher priority.

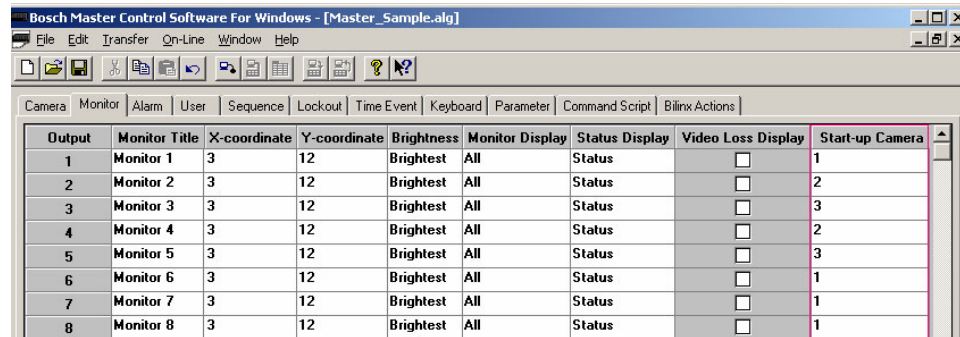

Figure 9: Main Site Sample Program Showing Monitor Start-Up Camera Numbers

9.6 Special Programming for “Cascaded” Satellite System Configurations

In a 3-tier cascaded satellite system, it is highly recommended for the system design to have more trunk lines between the intermediate master/satellite system and the 3rd level satellite system than there are between the top level master system and the intermediate system. In systems where this is not the case, it is likely that operators at top level master and the intermediate master/satellite will end up fighting for trunk lines coming from the 3rd level satellite system.

There are two user configuration options available (starting in CPU firmware version 8.70) to eliminate or at least significantly reduce conflicts between operators when this type of system is being used.

Option 1: Using Factory default settings, previously selected satellite cameras remain on trunk lines even after the operator switches back to a local camera view. Although this mode of operation is more desirable in standard systems because it minimizes delays when previous satellite cameras are reselected, it is not advantageous to use in cascaded systems. In cascaded systems, all available trunk lines coming from the 3rd level satellite system may become used up, making them unavailable to the operators at the intermediate system.

In this situation, keyboard User Function 41 should be set to the NO REM CAM CACHE option at the master site location. In this mode, after the top level operator selects a locally connected camera, the trunk line between the top level and the intermediate level system will immediately be reset to its Start-up camera (as defined in the Monitor Table of the LTC 8059/00 MCS). This action frees the trunk line between the intermediate level system and the 3rd level system so it will be available if needed by an operator at the intermediate level system.

For the monitors being used as trunk lines in the intermediate system, it is important for the “Start-up” camera numbers listed in the Monitor Table of the LTC 8059/00 software to be programmed to specify cameras connected locally or a local unused input (i.e., the raster generator will be displayed when called up). This action ensures that no trunk line is used when a monitor switches to the Start-up camera.

Option 2: If the top level master system and intermediate level system in a cascade configuration can or will be set to operate as “Dual Master” systems, a priority based satellite camera feature can be configured.

In default cascaded satellite system configurations, satellite switching commands are not associated with a user priority level. When a switching command sent from a master site is received by a satellite, the switch selection can immediately be overridden by operators at the satellite location who have any priority level. This situation is more likely to be encountered in 3-tier Satellite systems that do not have a good distribution of trunk lines (i.e., more between the top level system and the intermediate level system than there are between the intermediate system and the 3rd tier satellite).

Since dual master configurations support bi-directional communications, it is possible to set keyboard User Function 41 to use the SAT nnn PRIORITY option for both the top level and intermediate level master systems. The satellite number assigned to the system that is currently being programmed must be specified here. This feature will enable use of the operator’s user priority to determine if access to a desired satellite camera is provided or not. For instance, if no trunk lines are available and

an operator requesting a satellite camera has a higher priority than at least 1 of the existing operators, the requested camera will be switched. If the operator does not have sufficient priority, they will receive an error message (i.e., error 81) via the satellite communication path, and their camera will switch to the Start-up camera specified in the Monitor Table.

9.7 Alarm Inputs in Satellite Systems

Any alarm inputs to the main site, which have been programmed to activate cameras located at satellites, will operate normally except when limited by the number of trunk lines available. The software automatically determines trunk usage depending on the priority level of operators currently viewing satellite cameras. Alarm inputs applied at a satellite site will not activate the alarm video at the main site. If the application requires alarms located at a satellite to activate video at the main site, the remote alarms must be brought back to the main site. If necessary, the main site's LTC 8540/00 Alarm Interface unit can be remotely located via an RS-232 link. Since the Alarm Interface capability is an integral part of the LTC 8100, LTC 8200, and LTC 8300 Series, this is not possible if an LTC 8100, LTC 8200, or LTC 8300 Series system is being used as the main site system. If more than one satellite site contains alarms, multiple LTC 8540/00 Alarm Interfaces can be remotely located. The number of alarm interfaces which can be remoted is limited only by the capacity of the main site system to support this capability.

10 Feature Selection

Certain user-selectable features can provide enhanced Allegiant system operation capabilities. Any desired changes can be made now or delayed until specific system requirements become more apparent. Refer to the Factory Default Settings Section for a full description of these features and selection instructions.

11 Main Power Connections

1. Verify that the power supply is configured for the desired voltage input. Attach the supplied AC power cord between the bay and appropriate AC power source. If necessary, instructions for changing the input voltage selection can be found in the Maintenance Section of this manual (See Chapter 18, "Maintenance Information," on page 65) Switch power ON to the bay(s).

NOTE The system may require several seconds to fully initialize after a power-up reset. This time can vary based on the activity and general size of the system.

2. Verify that the LEDs associated with the fuses are lit on all of the applicable power supplies.

Installations having cameras powered from an AC phase different than that of the Allegiant system may utilize the built in EXTERNAL SYNC input or vertical PHASE ADJUST.

NOTE All cameras should be phased properly with each other before the EXTERNAL SYNC or PHASE ADJUST feature is implemented.

The EXTERNAL SYNC input will accept composite video, composite sync, or output from a Master Sync generator. Any one of the phased cameras may be used as a master sync source to the system using the EXTERNAL SYNC input. To implement this feature, simply connect the incoming video source (using a BNC "T" connector) to both the appropriate camera BNC input and the EXTERNAL SYNC input which is found on the rear of the Allegiant CPU bay. The front panel illuminates the EXT SYNC LED. Alternatively, the PHASE ADJ on the front panel of the power supply may be adjusted until the vertical interval switching is achieved. The PHASE ADJUST has a range of about 130 degrees.

3. Reattach the front panel(s) to the bay(s).

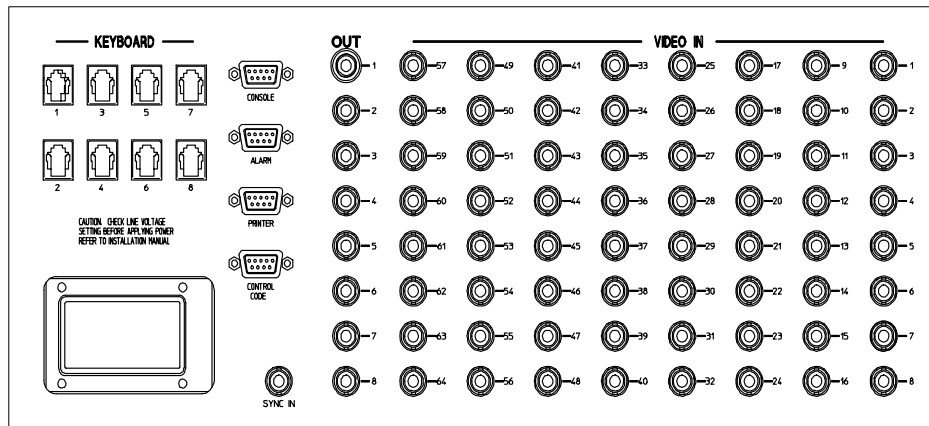
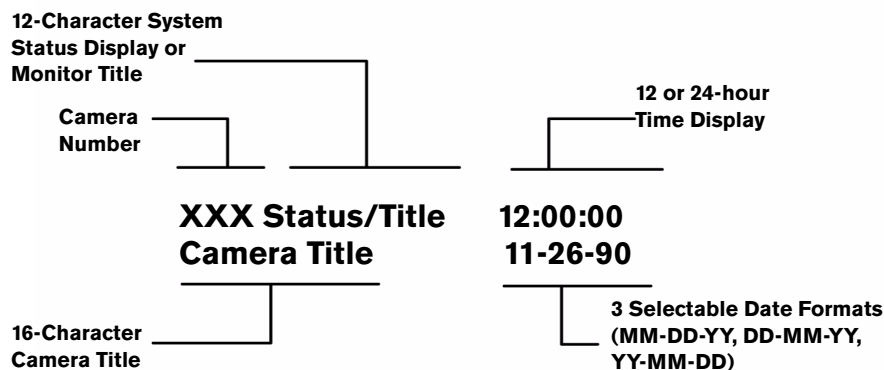

Figure 10: LTC 8501 Series Rear Panel

12 Video Monitor Display

The Allegiant Series system features an integral text overlay with two (2) rows of 24 characters each. There are a total of 256 different characters that the system can display. See Chapter 19, “Character ROM Tables for LTC 8500,” on page 68.

The display is broken down into five (5) areas as shown in the figure below:



LTC8500overlay.eps

Figure 11: Monitor Overlay Display

12.1 Time / Date

The time/date display is generated by the system CPU microprocessor module. It is crystal controlled and battery protected for one year (minimum) without power. The display is updated once per second and all monitors update simultaneously. The time/date message is always on the right side of the video display with the time on the top line. Time displays hours, minutes, and seconds, and can be set to either 12-hour or 24-hour operation. The date is available in three (3) user-selectable formats:

1. U.S. Format - The order for the American date display is: MM/DD/YY. (Default for 120 VAC systems)
2. International Format - The order for the international date display is: DD/MM/YY (Default for 220-240 VAC systems)
3. Asian Format - The order for the Asian date display is: YY/MM/DD

12.2 Monitor Title/System Status Display

The monitor title/system status display area is a 12-column display to the right of the camera number. It is unique on each of the monitors. It has different uses, some of which may be selected by the user at a keyboard location. The various uses are described below.

Monitor Message

The monitor message is a stationary 12-character title which may be placed on a monitor instead of the system status display. A specific monitor message can be programmed using the keyboard (see User Function 17), the optional LTC 8059/00 MCS package, or the optional LTC 8850/00 GUI Software package.

System Status Display

If this display is selected (factory default), it allows the Allegiant system to dynamically inform the user of the system status. The 12-column display is divided into smaller message columns (see figure below), in which special characters inform the user of the following:

- if the switcher is running or stopped
- the switcher's direction
- if a monitor or remote camera is locked
- the alarm status of the camera and monitor

1	2	3	4	5	6	7	8	9	10	11	12
A	A	A	M	C	E	R	M	A	S	S	S
l	l	l	o	a	r	e	o	b	e	e	e
a	a	a	n	m	r	m	n	s	q	q	q
r	r	r			o			/			
m	m	m	A	A	r	L	L	R	N	N	S
			r	r	/	o	o	e	u	u	t
			m	m	D	c	c	l	m	m	a
					l	k	k				
					R						

Format of Monitor Overlay's System Status Display

- **Locations 1, 2, and 3 - Alarm Indication**

When the monitor overlay is in the status display mode, locations 1 through 3 indicate if a camera on the monitor is in the alarm mode. If the on-screen camera is currently in alarm mode, an ALM message will flash in a box at this location mode. If no cameras are currently in alarm mode on this monitor, these spaces are blank. Note that when a monitor has cameras in alarm mode, pressing [NEXT], [RUN], or [PREVIOUS] on the keyboard will move you through the alarm sequencer rather than the regular camera sequencer. The alarm switcher status will be displayed in location 6 using described symbols.

- **Location 4 - Monitor Arm Status Indication**

In the MONITOR ARMED location, the characters S_M or D_M will appear if the monitor is armed for alarm. S_M means that the monitor is a "step" or "sequence" monitor, and will automatically step through multiple alarm videos. D_M indicates that the monitor is a "display" or "review" monitor, which will collect alarm videos from one or more step monitors.

When an alarm occurs, the alarmed camera's video will replace the current display of the monitor. If the monitor is not armed, this location will be blank.

- **Location 5 - Camera Arm Status Indication**

In the CAMERA ARMED location characters C_A are displayed if the camera being viewed is armed for alarm on that monitor. If the alarm signal associated with this camera becomes active, the camera will be displayed on the appropriate armed monitors.

- **Location 6 - Error Indication**

This location is used to indicate an error on the part of the user. When a user error occurs, this location will display an ERR symbol. The specific error number will appear in locations 7 and 8. The error number will also appear in the Camera Number Display field on the keyboard. The display will return to normal after a few seconds have passed, or if the user presses [Enter] on the keyboard.

Location 6 is also used to indicate the sequencing direction when alarms occur. One of four of the following character combinations will be displayed:

- \hat{R} indicates the alarms are sequencing in a forward direction.
- $\overset{R}{V}$ indicates the alarms are sequencing in a reverse direction.
- \hat{S} indicates the sequencing of alarms has stopped, but if started again would sequence in a forward direction.
- $\overset{S}{V}$ indicates the sequencing of alarms has stopped, but if started again would sequence in a reverse direction.

Location 6 can also be used to display a symbol to indicate pan/tilt/zoom equipped cameras. Using the keyboard (see User Function 35), or the optional LTC 8059/00 MCS, controllable cameras can be individually selected to display a “◁▷” symbol in location 6 whenever they are viewed on a system monitor.

- **Location 7 - Remote Lock Indication**

This location will display characters $\overset{R}{L}$ to indicate that control over the movements of the camera being viewed have been “locked” by a user. Control over this camera is now possible only by the user who locked the camera or by a user with higher priority. If the camera is not locked, the icon will not be displayed. If a user error has occurred, this location will temporarily hold part of the error number.

- **Location 8 - Monitor Lock Indication**

This location will display characters $\overset{M}{L}$ to indicate that the monitor has been “locked” by a user. The camera currently being viewed can not be changed except by the user who locked the monitor or one with higher priority. If the monitor is not locked, the icon will not be displayed. If a user error has occurred, this location will temporarily hold part of the error number.

- **Location 9 - Sequence Type Indication**

This location is used to display the type of sequence currently “loaded” on the monitor. An “absolute sequence” is indicated by the characters $\overset{A}{S}$ which means that the monitors programmed in the sequence program refer to the exact monitor(s) from which the sequence may be run. Sequences created using the system keyboards are always of this type, so absolute sequences are the only type possible in a base system. Sequences designated as “relative sequences” are designated by the characters $\overset{R}{S}$ in this location. These sequences run on any monitor or group of monitors and can be programmed only using the optional LTC 8059/00 MCS package or the optional LTC 8850/00 GUI Software package with a personal computer.

- **Locations 10 and 11 - Sequence Number**

The sequence number currently active for the monitor is displayed in these two (2) locations. This number is between 1 and 60, or 00 to indicate that no sequence is loaded.

- **Location 12 - Sequence Status Indication**

This location indicates the status of the sequence “active” in the monitor. There are four possible character combinations:

- a. \hat{R} indicates the current sequence is sequencing in a forward direction.
- b. $\overset{R}{V}$ indicates the current sequence is sequencing in a reverse direction.
- c. \hat{S} indicates the sequence is stopped, but if started again would sequence in a forward direction.
- d. $\overset{S}{V}$ indicates the sequence is stopped, but if started again would sequence in a reverse direction.

- **Broadcast Message**

The operator of the personal computer can send a message using the optional LTC 8059/00 MCS package or the optional LTC 8850/00 GUI Software package to all monitors in the system. This message may be up to 12 characters long and can be used to notify all users at all monitor locations of important information. The message, along with its beginning and ending time and date, is also printed out on the logging printer, if one is connected; and any acknowledgment from users is also recorded. The broadcast duration may be set for 1 to 60 seconds. The message temporarily overwrites the 12-character monitor title/system status display.

- **Program Prompts**

During entry of sequence programming using the keyboard, the Allegiant system prompts the user on the monitor his keyboard is currently “controlling”. The display will return to its previous form when the user leaves the programming mode.

- **Camera Number**

The left-most display on the top line shows the camera number. This number is generated by the system and is always displayed. Each number is unique and identifies this camera when using the keyboard for video call-ups.

In base systems, this number is the same as the numbered BNC connector that the camera is plugged into on the rear of the bay (physical camera number). However, the optional LTC 8059/00 MCS package or the optional LTC 8850/00 GUI Software package can be used to change this number to any unique number between 1 and 999.

- **Camera Title**

The camera identification display is the first 16 characters of the lower line. These 16 characters label each camera with its own title, and is displayed whenever that camera is called-up. The characters can be entered from the keyboard (see User Function 9) or may be entered from the personal computer keyboard. There are a total of 256 different characters that can be displayed. See Chapter 19, “Character ROM Tables for LTC 8500,” on page 68.

13 Factory Default Settings

As the Allegiant system is shipped from the factory, certain features are placed in a default configuration. The installer can select some of these features at the time of system installation/configuration. Generally the default configuration represents the simplest mode of operation, allowing the user to become familiar with the system before any advanced features are selected. The default settings are described in the sections below.

13.1 User Selectable DIP Switch Settings for Main CPU Bay

NOTE After changing any of the following switches, the system must either be powered OFF and ON or reset using the keyboard (see User Function 15).

Upper CPU DIP Switch S1001

System CPU modules contain two (2) 8-position DIP switches. The settings of the upper DIP switch do not need to be changed from their factory default positions except when using a Console Port Expander accessory unit or if a problem is encountered when downloading new firmware into the CPU. For reference, the functions are as follows:

DIP Switch Number	Factory Default Setting	“Upper” S1001 DIP Switch Function
1	OFF	Not Used
2	OFF	Not Used
3	OFF	Console Expander Use
4	OFF	Console Expander Mode
5	OFF	Boot Mode
6	OFF	Boot Mode Handshake
7	OFF	Boot Mode Baud Rate
8	OFF	Boot Mode Baud Rate

- **Switch 1 and 2 of S1001**

These switches are not used in these systems and should be left OFF.

- **Switch 3 of S1001**

This switch should be set to ON if an LTC 8712 Series Console Port Expander is connected to the Allegiant’s console port. This selection can also be set using either the MCS or the PC-based GUI Software package.

- **Switch 4 of S1001**

This switch is used to set the communication baud rate which the Allegiant will use when connected to a LTC 8712 Series Console Port Expander. It is only applicable when DIP switch 3 is in the ON position. When set to ON, the baud rate will be 57,600 bps (recommended setting). When OFF, the baud rate follows the setting determined via DIP switch 8 of the lower CPU DIP switch. If switch 8 of the lower DIP switch is OFF, the baud rate defaults to 19,200 bps. If switch 8 of the lower DIP switch is ON, the user programmed baud setting is used, but the user setting must be 19,200 baud or higher in order to operate.

- **Switch 5 of S1001**

In the ON position, this switch is used to force the CPU into a “boot” mode so it is ready to accept a download of an operating system program via its console port. This setting should not be changed unless a problem has been encountered while attempting to download a new operating system program.

- **Switch 6 of S1001**

This switch selects the handshake setting of the console port when switch 5 (described above) is in the ON position. When ON, the handshake is enabled (recommended position).

- **Switch 7 and Switch 8 of S1001**

These switches are used to set the baud rate when downloading a new operating system program. It is recommended to use the fastest rate possible.

Switch 7	Switch 8	Switch Rate	Baud
OFF	OFF	38400	
OFF	OFF	19200	
ON	OFF	9600	
ON	OFF	OFF	1200

Lower CPU DIP Switch S1002

The lower DIP switch provides several user-selectable options. These options are as follows:

DIP Switch Number	Factory Default Setting	“Lower” S1002 DIP Switch Function
1	OFF	Reserved
2	OFF	Alarm Port Mode
3	OFF	Old Keyboard Modes
4	OFF	Printer Port Mode
5	ON	Security Feature
6	OFF	Not Used
7	ON	Keyboard Protocol Mode
8	ON	Communication Parameters

- **Switch 1 of S1002**

This switch is not used in these systems and should be left OFF.

- **Switch 2 of S1002**

This switch allows the alarm port on the rear of the main Allegiant bay to configure as an auxiliary console port when switch 2 is turned ON. This auxiliary port allows the alarm port (in addition to the regular console port) to communicate with the optional LTC 8059/00 MCS package or the optional LTC 8850/00 GUI Software package.

The port can also be used to control the Allegiant system via the Console Command Language (documented in the optional CCL manual). The normal console port and the alarm port (when switch 2 is ON) may be used to control the Allegiant system simultaneously. Communications parameters (baud & handshake) for the alarm port can be set using the keyboard (see User Function 32), with the optional LTC 8059/00 MCS package or with the optional LTC 8850/00 GUI Software package.

Note that the pin-out of the alarm port differs from that of the console port, so the cable supplied with the optional LTC 8059/00 MCS package or with the optional LTC 8850/00 GUI Software package can not be used when interfacing with the alarm port. If necessary, see Section 23 “Main Bay Rear Panel Connector Pin-outs and Cable Pin-out,” on page 88 for the alarm port pin-outs.

- **Switch 3 of S1002**

This switch setting is ignored if DIP switch 7 (described below) is set to ON. Current systems utilize a “variable speed” keyboard communication protocol. Older systems and keyboards were limited to using “fixed speed” keyboard communication protocols. In addition, there were two types of fixed speed protocols available. By default, newer CPUs are set to operate using “six poll byte” variable speed mode, but if a newer CPU is installed into an older system, the existing keyboards would not operate with this format. This option switch is provided to support backward compatibility with the older style keyboards.

When this switch is set to OFF, the CPU communicates with the system keyboards using a “four poll byte” protocol. When it is ON, the keyboard communication uses an “eight poll byte” protocol.

This option is a global system setting that determines the communication protocol that will be used for all keyboards connected to the system.

For reference, the following table lists the Allegiant Series keyboard models and the protocol supported by each:

Keyboard model	Supported protocols
TC8550KB	4 poll byte
TC8550KB-8	8 poll byte
TC8550	4 or 8 poll byte
TC8550A, TC8551A, TC8553	4, 6, or 8 poll byte
TC8554, TC8555	4, 6, or 8 poll byte
LTC 8553 Series	4, 6, or 8 poll byte
LTC 8555 Series	4, 6, or 8 poll byte
IntuiKey KBD-Universal	6 poll byte

- **Switch 4 of S1002**

This switch allows the printer port on the rear of the main Allegiant bay to be configured as an auxiliary console port when it is turned ON. See the description above regarding switch 2 for information on using an auxiliary console port. The printer port has the same pin-out as the normal console port, so the console cable supplied with the optional LTC 8059/00 MCS package or with the optional LTC 8850/00 GUI Software package may be used to interface with the printer port when switch 4 is ON. Communication parameters (baud & handshake) for the printer port can be set using a keyboard (see User Function 31), or with the optional LTC 8059/00 MCS package or with the optional LTC 8850/00 GUI Software package.

NOTE This feature can also be implemented via the PRT2CON CCL command using an external PC, dumb terminal or other computing device. Refer to the Allegiant Command Console Language (CCL) manual for complete information about using CCL commands.

- **Switch 5 of S1002**

This switch controls the system security modes. When this switch is set to ON, the system log-in features can be controlled using keyboard User Function 27 and User Function 28 (refer to the section on Keyboard User Functions for complete information). Users with Priority 1 can access keyboard User Function 27 to select if the system keyboard log-in feature is enabled or disabled. When enabled, the system keyboards require each user to log into the system and to log-off the system. All users are required to enter a user number and the correct password before the system permits interaction.

Users with Priority 1 can also access User Function 28 to select if the console port log-in feature is enabled or disabled. When enabled, any external PC or other computing device is required to log into the system and to log-off the system. All users are required to enter a user number and the correct password before the system permits interaction.

If this switch is turned OFF or if the features are disabled using User Functions 27 and 28, the system keyboards and the console port are always online with the system.

NOTE When changing from the no 'log-on' mode to the 'log-on' mode, all system keyboards are initially 'logged-off'.

- **Switch 6 of S1002**

This switch is currently not used and should be left OFF.

- **Switch 7 of S1002**

This switch controls the system keyboard polling mode. When switch 7 is ON (factory default), the CPU communicates with all system keyboards via a “6 poll byte” communication protocol. This format provides variable speed pan/tilt control for AutoDome-equipped camera sites. Refer to the information for Switch 3, above, for more details.

NOTE The variable speed mode is not compatible with the pre-1996TC 8561 receiver/drivers without using an LTC 8785 Series Code Converter unit.

Dip switch 7 can be turned OFF (usually at system installation) to allow operation with the older fixed speed-only type keyboards that are able to communicate only using the older format. In this mode, the system can communicate with the older TC8561 Series of receiver/drivers without using the LTC 8785 Code Converter unit. Note that the fixed speed keyboard mode allows access to only the first 63 auxiliary and pre-position functions. This is not an issue on older receiver/driver versions, but may pose a problem if the system must be expected to access all functions available in the AutoDome Series of pan/tilt/zoom dome cameras or the higher preposition numbers in current versions of Allegiant receiver/drivers.

- **Switch 8 of S1002**

This switch controls the protocol settings of the external RS-232 port which connect to the Console, Printer, and Alarm.

If the switch is turned OFF, the system uses the factory default settings for the RS-232 data communication protocols as listed below.

With switch 8 ON, any RS-232 port protocols changed using the keyboard (see User Function 30), the optional LTC 8059/00 MCS package, or the optional LTC 8850/00 GUI Software package are active.

User Selectable DIP Switch Settings for Main CPU Bay

Users with Priority Level 1 can also use the keyboard (see User Function 29) to reset any changed protocols back to the default settings (see below).

Switch 8 also controls the activation of a “boot screen” Command Script program previously downloaded into the CPU's memory. Command Scripts are user-defined programs designed to provide special system functions or features at system startup or reset. If the switch setting is OFF, any existing boot screen function will not be activated.

The default (DIP switch 8 OFF or after activation of Keyboard User Function 29) data communication settings for the Allegiant system are listed below.

Settings	Console Port	Printer Port	Alarm Port	Keyboard Ports
Baud Rate	19,200	19,200	19,200	9600
Stop Bits	1	1	1	--
Data Bits	8	8	8	--
Parity	None	None	None	--
Handshake	Yes	No	No	--

14 User Information

14.1 User Priority Levels

There are eight (8) levels of user priority in the Allegiant system. Each of the 32 users in the Allegiant system has a default priority level assignment. These user levels determine access to various system functions and provide a means to prioritize user control of monitors and pan/tilt/zoom equipped camera sites. Generally, users with higher priority (highest = 1) can regain control over monitors or pan/tilt/zoom cameras 'locked' by another user.

User Number	Default Password	Priority Level	Default Keyboard
1	1	1	1
2	2	2	2
3	3	2	3
4	4	2	4
5	5	8	5
6	6	8	6
7	7	8	7
8	8	2	8
9	9	2	--
10	10	2	--
11	11	2	--
12	12	2	--
13	13	2	--
14	14	2	--
15	15	2	--
16	16	2	--
17	17	2	--
18	18	2	--
19	19	2	--
20	20	2	--
21	21	8	--
22	22	8	--
23	23	8	--
24	24	8	--
25	25	8	--
26	26	8	--
27	27	8	--
28	28	8	--
29	29	8	--
30	30	8	--
31	31	8	--
32	32	8	--

The table above shows the default values of a base system. The 8 priority level user assignments can be changed using the optional LTC 8059/00 MCS package or the optional LTC 8850/00 GUI Software package. Note that in base systems where the keyboard log-in feature has not been selected, a user number is automatically assigned to a specific keyboard port. In this mode, setting the priority of the default user essentially determines the priority level of the keyboard during operation. Also shown in the table is the default user passwords assigned to each user as the system

is shipped from the factory. Once a user is logged into the system, the password can be changed using the keyboard (see User Function number 10). Refer to the specific section of the operation instructions for exact procedures of using keyboard User Functions. Although the table indicates 32 possible users, only eight (8) keyboards are supported in LTC 8500 Series systems.

14.2 User Priority Access Table

The following table shows system function access as it applies to the eight (8) levels of users.

System Function	Priority Level		
	1	2 to 7	8
Switch video on monitors	Yes	Yes	Yes
Control pan/tilt/zoom camera	Yes	Yes	Yes
Lock monitor	Yes	Yes	Yes
Lock pan/tilt/zoom camera	Yes	Yes	Yes
Acknowledge alarms	Yes	Yes	Yes
Perform keyboard test	Yes	Yes	Yes
Show keyboard number	Yes	Yes	Yes
Activate keyboard beeper	Yes	Yes	Yes
Change user password	Yes	Yes	Yes
Program sequences	Yes	Yes	No
Position video overlay display	Yes	Yes	No
Set overlay display brightness	Yes	Yes	No
Select overlay display type	Yes	Yes	No
Set system time/date	Yes	Yes	No
Program pre-positions	Yes	Yes	No
Set time/date format	Yes	No	No
Set camera and monitor titles	Yes	No	No
Enable time events	Yes	No	No
Reset system	Yes	No	No
Printout tables and sequences	Yes	No	No
Default monitor overlay	Yes	No	No
Select alarm response mode	Yes	No	No
Select printer mode	Yes	No	No
Designate alarm monitor type	Yes	No	No
Select keyboard log-in	Yes	No	No
Select console log-in	Yes	No	No
Configure/reset RS-232 ports	Yes	No	No

15 Alarm Information

15.1 General

The ability to automatically switch video in response to an external signal (usually a contact closure) is a necessary feature in any video switching system. The Allegiant system permits users with Priority Level 1 to select any 1 of 3 predefined alarm response modes (via keyboard User Function 19). A description of these three (3) modes appears below. Pictorial examples of the three (3) alarm responses are also shown on the following pages.

The system can also be programmed with a wide variety of alarm response characteristics using the optional LTC 8059/00 MCS package or the optional LTC 8850/00 GUI Software package.

15.2 Basic Alarm Response Mode

In the Basic alarm response mode, any or all of the monitors can be selected as alarm display monitors. Each alarm can then be armed to display its camera(s) on any set of armed monitors. Multiple alarms, on the same monitor, will sequence at a 2 second rate. Note that monitors and alarms can be armed and disarmed individually as required. Alarmed video automatically clears when the alarm input signal is reset.

15.3 Auto Build Alarm Response Mode

This mode uses a set of monitors as alarm display monitors. All system monitors may be armed if desired. Each triggered alarm will display its alarm video on a different monitor, starting with the lowest numbered armed monitor. If all the armed monitors are already displaying alarm video, subsequent alarms will build on the existing alarmed monitors; and each monitor will sequence through its alarm videos at a 2 second rate. Note that monitors and alarms can be armed and disarmed individually as required. Alarmed video will automatically clear when the alarm input signal is reset.

15.4 Sequence and Display Alarm Response Mode

This mode designates two monitors as alarm response monitors. Monitor #1 is the DISPLAY monitor (also called a REVIEW monitor) and monitor #2 is the SEQUENCE (or STEP) monitor. The first alarm appears on both monitors and additional alarms begin to sequence at a 2 second rate on the SEQUENCE monitor. The DISPLAY monitor holds the first alarmed camera video until manually acknowledged through the keyboard. When the first video is cleared from the DISPLAY monitor, the next alarmed video ("next" meaning the camera that enters an alarmed state second) is displayed until cleared; operation continues in this manner. Note that alarms can be armed and disarmed individually as required. Note also that all alarms must be manually cleared; the presence of alarm video is not dependent upon the duration of the alarm input signal to the system.

15.5 Alarm Activated Pre-position

Alarm activated pre-position capability exists in each of the three (3) alarm response modes. This enables a pan/tilt/zoom equipped camera to automatically position itself to a preprogrammed scene as a result of an alarm signal. When using conventional pan/tilt equipped devices and zoom lenses, they must have the necessary options for pre-position control. The system default is to activate **pre-position #16** of the system camera receiving an alarm. Using the optional LTC 8059/00 MCS package or the optional LTC 8850/00 GUI Software package, the user can configure a response to alarms as required.

15.6 Sample Alarm Responses

Basic Mode

In the Basic alarm response mode, cameras are individually armed for each alarm monitor.

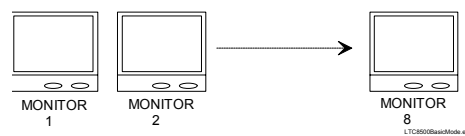

Auto-Build Mode

In the Auto-Build alarm response mode, alarms “build-up” on armed monitors as new alarms are received.

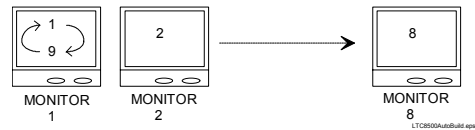

Alarm Status	Alarm Station Display
1st Alarm	Video associated with 1st alarm is displayed on any or all appropriately armed monitors.
2nd Alarm	Video associated with 2nd alarm is displayed on any or all appropriately armed monitors.
3rd Alarm	Video associated with 3rd alarm is displayed on any or all appropriately armed monitors.

Monitors and their respectively armed cameras are programmed individually.

Multiple alarms on monitors are sequenced automatically.

Alarmed video remains on monitors for duration of alarm input signal.

Alarm Status	Alarm Station Display
1st Alarm	Video associated with 1st alarm is displayed on monitor # 1 (if armed).
2nd Alarm	Video associated with 2nd alarm is displayed on monitor # 2 (if armed).
3rd Alarm	Video associated with 3rd alarm is displayed on monitor # 3 (if armed).
.	
.	
.	
8th Alarm	Video associated with 8th alarm is displayed on monitor # 8 (if armed).
9th Alarm	Video associated with 9th alarm is sequenced with video of 1st alarm on monitor # 1.

Any number of monitors may be armed.

Multiple alarms on monitors are sequenced automatically. Alarm video remains on monitors for duration of alarm input signal.

Sequence & Display Mode

In the Sequence & Display mode alarm response mode, a monitor pair is used to display alarmed video.

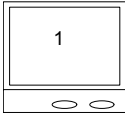
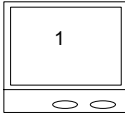
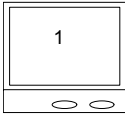
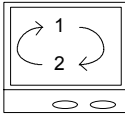
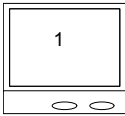
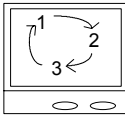
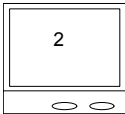
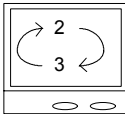
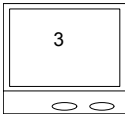
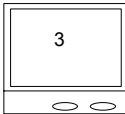
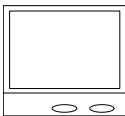
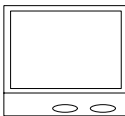
	Display Monitor	Sequence Monitor	Monitor Actions	Keyboard Operator Action
1st Alarm Occurs			D = Video associated with 1st alarm is displayed. S = Video associated with 1st alarm is displayed.	NONE
2nd Alarm Occurs			D = Video associated with 1st alarm is displayed. S = Video associated with 1st and 2nd alarm is displayed.	NONE
3rd Alarm Occurs			D = Video associated with 1st alarm is displayed. S = Video associated with 1st, 2nd and 3rd alarm is displayed.	NONE
			D = 1st alarm video is removed. 2nd alarm video is now displayed. S = Video associated with 2nd and 3rd alarms continue to sequence.	1st Alarm Acknowledged
			D = 2nd alarm video is removed. 3rd alarm video is now displayed. S = Only video associated with 2nd alarm remains.	2nd Alarm Acknowledged
			Since all alarms have been acknowledged, both monitors return to normal operator control.	3rd Alarm Acknowledged

15.7 Alarm Relay Response

Allegiant alarm responses include the ability to trigger isolated alarm relay outputs from an LTC 8540/00 Alarm Interface unit. An alarm output is typically used to activate the alarm input of a security Digital Video Recorder (DVR) or other alerting device. In this type of scenario, a DVR is programmed to change recording speeds from a slower rate to a faster rate upon alarm activation. Operation of the relay outputs from the LTC 8540 Alarm Interface unit depends on the system configuration for responding to alarm events. The alarm output relays behave according to the following conditions:

1. Relay 1 activates if the system uses the Basic alarm response mode and an alarm occurs on any system monitor. Relay 1 deactivates after all alarms have been removed from the inputs. Relay 1 also deactivates if the system (monitor or alarms) is disarmed by an operator via the keyboard. Pressing [Acknowledge] on the system keyboard does not deactivate Relay 1 since the alarm video follows the contact applied to the unit in this alarm response mode. Other relays are not used in this mode.
2. Relay 1 activates if the base system is set to use the Sequence & Display alarm response mode and an alarm occurs on any system monitor. Relay 1 deactivates after all alarm videos have been acknowledged (by pressing the [Acknowledge] key) via system operator(s) from all system monitors. Relay 1 also deactivates if the system is disarmed (either the monitor or the alarm(s)) by an operator via the keyboard. Removal of the alarm input does not deactivate Relay 1 since the alarm video(s) are not dependent on duration of the contact applied to the unit in this alarm response mode. Other relays are not used in this mode.
3. If the base system uses the Autobuild alarm response mode and an alarm occurs on system monitors, the relay corresponding to the monitor number activates for the duration that the corresponding alarm input is applied to the unit. The relay deactivates if the monitor associated with the relay or if the alarm(s) being displayed on the monitor is disarmed by an operator via the keyboard. Pressing [Acknowledge] on the system keyboard does not deactivate the relays since the alarm video follows the contact applied to the unit in this alarm response mode.
4. If the Alarm Group table screen, in the PC-based LTC 8059/00 MCS package or the LTC 8850/00 GUI Software, contains an alarm group that includes monitors and the monitor option has been selected in the Relay Action column, the corresponding relay activates for the duration the alarm video remains on the monitor. The relay deactivates if the associated monitor (or the alarm(s) being displayed on the monitor) is disarmed by an operator via the keyboard. Pressing [Acknowledge] on the system keyboard does not deactivate the relay unless this feature has been selected for the associated alarm group. If the Monitor option has been set to 1 in the group table, only Relay 1 activates when monitors in that alarm group become alarmed.

16 Keyboard Operation

16.1 General

Primary operation of an Allegiant switcher is controlled via the system keyboard. The two types of keyboards currently available are:

- Conventional LTC 8555 Series (incorporates LEDs and pushbuttons).
- IntuiKey model (uses dynamic LCD menu screens).

General operation steps for both keyboard models follows. Refer to the individual instruction manuals supplied with the keyboard for additional information.

As the system is supplied from the factory, various user selectable features are set to a default state. See Chapter 13, “Factory Default Settings,” on page 33 for complete feature descriptions. Since these features are user selectable and can have a significant effect on the operation of the system, it is important to take note of any changes that may be in effect.

16.2 System Commands

Keyboard Log-in Procedure

Keyboard modes:

- Factory default, a keyboard is ready for use as soon as power is applied to the system.
- System operator must log-on to a keyboard to access the system. When a system is configured to use the keyboard log-on, operators must be pre-assigned a user number and password. Up to 32 user numbers are available, each having default priority level. User specific priority levels can be changed only via the optional PC-based LTC 8059/00 MCS package or the LTC 8850/00 GUI Software. Refer to the software manual for complete details.

If the log-on feature is enabled and an operator is not logged-in, LED keyboards show flashing dashes in their display. IntuiKey keyboards prompt for entry of a user number when attempting to enter the main Allegiant softscreen menu.

Enter your assigned user number via the numeric keypad and press [Enter]. When prompted, enter the password. Invalid passwords cause the keyboard to revert to its initial state. Once the log-in is successful, the keyboard will show camera and monitor numbers in its display.

Upon logging in, the monitor controlled by the keyboard may automatically switch to a pre-assigned camera number. This function is only applicable if enabled by the system administrator (via the optional MCS package) and may not function if the monitor is running a sequence and/or in an alarm condition.

NOTE The information below applies to both IntuiKey keyboards and the LTC 8555 Series keyboards. Where applicable, button designations specific to IntuiKey keyboards are shown in plain text. Equivalent button designations that apply to the LTC 8555 Series keyboards are placed in brackets ([]) immediately after the IntuiKey button text.

Keyboard Log-off Procedure

If the log-in feature has not been enabled, this action is not applicable. If the feature has been enabled, press: User Log-off [User, then OFF].

Any priority based remote control or monitor locks made by the user will automatically be released at time of log-off.

16.3 Switcher Commands

- Camera Selection: Enter a camera number for viewing and press [Enter]. (The keyboard default mode is the camera mode).
- Monitor Selection: Press MON [Monitor], enter a monitor number and press [Enter].

16.4 Controlling Camera Movement

General

Camera positioning is controlled via an eight-way joystick on the right-hand side of the keyboard. This joystick controls the camera pan/tilt (if equipped), moves the camera up, down, left, right, or diagonally. Moving the joystick up and to the right simultaneously moves the camera in a diagonal direction.

Rotate the joystick knob to control the zoom lens in or out. The direction of its response depends on the camera/lens model and certain system configuration settings that are determined at installation. Up to four pan/tilt/zoom commands may be sent to a remote camera site at a time (Example - Zoom In, Focus Far, Pan Left, and Tilt Down). All three (3) zoom lens functions can also be sent simultaneously (Example - Zoom Out, Focus Near, Iris Open).

Focus and Iris Lens Control

The lens control buttons are on the right side of the keyboard. The camera's zoom lens (if equipped) is controlled to focus near or far, and open or close the iris (if the lens supports manual iris operation).

Lock or Unlock Control of a Camera

When using IntuiKey keyboards, press [Device Lockout], located on the main Allegiant menu screen to enter a menu screen for these options. With the LTC 8555 Series keyboards, press [Lock], then [ON] to lock a camera. To unlock a camera, press [OFF]. If the camera to be locked is not the one currently being viewed, enter the camera number via the numeric keyboard (but do not press [Enter]) before pressing [Lock].

If the Status option is enabled, the section of the onscreen overlay between the camera number and the time shows R_L , indicating the camera is locked. Activating a camera lock immediately prevents other operators (unless they have a higher priority) from controlling the locked pan/tilt/zoom camera. Remember to unlock the camera when finished so other operators can access it.

Lock or Unlock Control of a Monitor

- When using IntuiKey keyboards, press [Device Lockout], located on the main Allegiant menu screen for these options.
- With LTC 8555 Series keyboards, press [Monitor], [Lock], then [ON] to lock a monitor or [OFF] to unlock the monitor. If the monitor to be unlocked is not the one currently being controlled by the keyboard, enter the monitor number (but do not press [Enter]) after you press [Monitor].

If the Status option is enabled, the section of the on-screen overlay between the camera number and the time shows M_L indicating the monitor is locked. This status prevents other operators from changing the video on the monitor being used (unless they have a higher priority). Remember to unlock the monitor when finished so other operators can access it. If an operator with a higher priority accesses a locked monitor and switches to a different camera, the lock is automatically removed.

Recording a Camera Pre-position Scene

Select a camera with pan/tilt/zoom control and with preposition options. Using the joystick and lens controls, adjust the camera to view the scene you wish to store. When using IntuiKey keyboards, press [Camera Control], located on the main Allegiant menu screen to enter a menu screen with this option. Press Set Shot [Set], then select the scene number via the numeric keypad, and press [Enter]. The camera position is stored for recall later.

If an AutoDome Series camera is being used, certain pre-position commands are also used to activate operational features/functions. Refer to the AutoDome operation manual for complete information.

If an Allegiant conventional receiver/driver is being controlled, the pan/tilt and zoom lens must have the necessary options for pre-position operation. On certain models of AutoDomes and Allegiant Receiver/Driver Series, it is possible to disable a previously stored pre-position, or remove it from a pre-position tour, by pressing Set Shot [Set], the digit 9, followed by the 2-digit pre-position number. Refer to information supplied with the device to determine if it supports this feature.

NOTE Alarm activations are defaulted to call preposition scene 16.

Recalling a Camera Pre-position Scene

Select the camera to be activated. Press Shot, enter a previously stored camera position number via the numeric keypad, then press [Enter]. The camera automatically returns to the previously stored position. If a second pre-position is called prior to the completion of the first, the camera will move directly to the second shot.

If the AutoDome Series camera is being used, certain pre-position commands are also used to activate operational features/functions. Refer to the AutoDome operation manual for complete information.

Activate/Deactivate Auxiliary Function

When using IntuiKey keyboards, press [Camera Control], on the main Allegiant menu screen to enter a menu containing these options. To turn on an auxiliary function of a remote camera device, press Aux ON [ON], enter the number of the auxiliary you would like to activate and then press [Enter]. Holding the [Enter] key down causes the auxiliary function to be sent repeatedly. This capability is useful when the auxiliary is activating a housing window washer function, or a temporary light source.

To turn OFF an auxiliary function of a remote camera device, press Aux OFF [OFF], enter the number of the auxiliary you would like to deactivate and then press [Enter].

With the AutoDome Series of cameras, auxiliary commands are used to activate/deactivate certain operational features/functions. Refer to the AutoDome camera manual for complete information on features supported by the model.

In the Allegiant Receiver/Driver Series, the first four auxiliaries correspond to relay outputs. Option switches in the receiver/driver can configure these to operate as either latching or momentary type functions. If configured for the latching type, the auxiliary stays on once it is activated until it is turned OFF. If configured as momentary, the auxiliary remains on only as long as the [Enter] key is pressed. Auxiliary outputs 2 through 4 can also be configured as a contact closure, 24 VAC, or as line voltage. Auxiliary number 5 controls the DITHER function, detailed below. Auxiliary number 6 corresponds to an internal receiver/driver AUTOPANNING feature, previously enabled by an option switch inside the receiver/driver.

DITHER is a legacy Allegiant receiver/driver feature designed to extend the life of tube-based low-light level cameras. Its function was to prevent bright lights in the scene from burning a spot on the camera imager. When this feature is active and the pan/tilt is not moved for a period of about two minutes, the receiver/driver automatically pans right for approximately 0.5 seconds. Two minutes later, a pan left occurs, and the cycle continues until disabled. The feature is enabled by an option switch in the receiver/driver, and is controlled by the auxiliary 5 function. To activate the DITHER function, turn [ON] auxiliary 5. To deactivate the feature, turn OFF auxiliary 5. When first enabled, the pan/tilt unit makes one short left/right cycle to indicate that the DITHER function has been activated. Note that a camera in the DITHER mode will accumulate a viewing error if left unattended for a long period of time, so occasionally a manual adjustment of the pan/tilt may be required.

16.5 Alarm Commands

Arm/Disarm Individual Alarms

Alarm commands control the system's automatic video switching capabilities, in response to alarm signals.

When using IntuiKey keyboards, press [Alarm Control], located on the main Allegiant menu screen, to enter a menu screen with these options. To arm an individual alarm on the monitor currently controlled by the IntuiKey, press [Arm Alarm], enter the alarm number to be armed via the numeric keypad, then press [Enter]. To disarm an individual alarm when using the IntuiKey, press [Disarm Alarm], enter the alarm number to be disarmed via the numeric keypad, then press [Enter].

To arm/disarm an individual alarm when using an LTC 8555 Series keyboard, press [Alarm], enter the alarm number to be armed via the numeric keypad, then press [ON] to arm the alarm, or [OFF] to disarm it. The camera number activated by an alarm, by default, is the same as the alarm number, although this relationship can be changed via the optional Allegiant PC-based MCS package. When the alarm number does not match the camera number, it is important to specify the alarm number when using this command. The monitor status display (if enabled) shows C_A (camera/alarm armed) whenever an armed camera is selected.

Arm/Disarm All Alarms

Press [Alarm Control], located on the main Allegiant menu screen to enter the menu screen containing these options. When using the IntuiKey keyboard:

- To arm all alarms currently controlled on the monitor, press [Arm All Alarms].
- To disarm all alarms, press [Disarm All Alarms].

When using the LTC 8555 Series keyboard:

- To arm all alarms, press [User]. Then, press [Alarm] and then press [ON].
- To disarm all alarms, press [OFF].

Arm/Disarm Monitor

When using the IntuiKey keyboard:

- Press [Alarm Control], located on the main Allegiant menu screen to enter the screen with these options.
- To arm the monitor currently controlled, press [Arm Monitor].
- To disarm the monitor, press [Disarm Monitor].

When using the LTC 8555 Series keyboard:

- To arm the monitor, press [User]. Then, press [Monitor] and then press [ON] to arm all alarms.
- To disarm all alarms, press [OFF].

NOTE Alarm video appears on a monitor only if the monitor is armed and the alarm is armed for that monitor. The monitor status display (if enabled) will show M_A (monitor armed).

Alarms Acknowledgement

Bell [Ack] is provided so system operators can respond to alarms from the keyboard. Press Bell [Ack] when the keyboard is beeping (due to an alarm condition) to silence the beeper. Depending on alarm configuration programming, subsequent pressing of Bell [Ack] either clears an alarm video from the monitors or has no effect.

16.6 Sequence Control

Load/Clear a Sequence

To load a previously programmed sequence to run on your monitor, press Load Sequence [Seq], enter the desired sequence number (1 to 60), then press [Enter]. Note that loading a sequence does not automatically start the sequence running. Since sequences may be programmed to use more than one monitor, all required monitors must be available. If a sequence is already on a monitor, the operator who loaded it originally (or an operator with a higher priority) is permitted to load a new sequence on the monitor(s). Others will receive an error message.

To clear a monitor sequence, press Load sequence [Seq], then press [Enter]. Only the operator who originally loaded it (or an operator with a higher priority) is permitted to clear a monitor sequence. Others will receive an error message. If enabled, the status display area of the monitor indicates the sequence number in the appropriate location. If no sequence is currently loaded, 00 is displayed.

Run a Sequence

To run a sequence currently loaded on a monitor, press Start Sequence [Run]. If the sequence is stopped, the command starts sequencing. Direction of the sequencing is indicated in the monitor status display (if enabled), by a directional arrow and the letter R to the right of the sequence number. If Start Sequence [Run] is pressed while a sequence is already running, the switcher goes immediately to the next step in the sequence. Holding down Start Sequence [Run] produces a quick-scan effect. If Start Sequence [Run] is depressed when no sequence is loaded, an error results. If the monitor is in alarm, Start Sequence [Run] controls switching of alarm video rather than a loaded sequence.

Stop a Running Sequence

To stop a sequence that is currently running, press Hold Sequence [Hold]. The monitor status display shows a S to the right of the sequence number. If the sequence is already stopped, pressing Hold Sequence [Hold] has no effect. If no sequence is currently loaded, pressing Hold Sequence [Hold] results in an error condition. If the monitor is in alarm, Hold Sequence [Hold] stops the alarm switcher rather than a loaded sequence.

Controlling Sequence Direction

The direction of a sequence can be set to run either forward or reverse. It is also possible to manually step forward or reverse through a stopped sequence.

These actions work as follows:

If Next Sequence Step [Next] is pressed with the sequence in the stop state, the sequence switches forward and remains stopped. If the sequence is running when Next Sequence Step [Next] is pressed, it immediately goes to the next step and continues to run. The same is true for the Previous Sequence Step [Prev] button, but in the reverse direction. If either Next Sequence Step [Next] or Previous Sequence Step [Prev] is held down, quick-scan switching at a rate of approximately two steps per second will take place. When sequences are first loaded, their direction defaults to forward.

If Previous Sequence Step [Prev] is pressed while a camera sequence is running, it reverses the sequence. If Previous Sequence Step [Prev] is pushed while in a hold mode, and the display is showing the forward prompt, the first push changes the direction only, and a second push then switches to the previous step.

The same is true for Next Sequence Step [Next] in the opposite direction. The monitor status display shows an arrow pointing either up or down to indicate the sequence direction. The arrow will be to the right of the sequence number, either above or below the sequence run R or stopped S indicator. If the monitor is in alarm, Previous Sequence Step [Prev] and Next Sequence Step [Next] control the alarm switcher rather than the loaded sequence.

If no sequence is loaded, pressing Next Sequence Step [Next] or Previous Sequence Step [Prev] automatically steps the switcher through the camera numbers in numerical order.

16.7 Sequence Programming

Programming a Simple Camera Sequence

The Allegiant system has powerful sequencing capabilities. Using a system keyboard, it is possible to enter sequences to run on a single or on multiple monitors. As long as valid camera and monitor numbers are used, they can be entered into a sequence randomly. More powerful features are available when sequences are programmed via the PC-based LTC 8059 MCS, including receiver/driver activation as part of a sequence step.

Sequence programming is limited only by the amount of CPU memory reserved for storing the sequence steps.

The current limit for this Allegiant model is 3000 steps. Comparing a sequence to a spreadsheet, a simple sequence would consist of three (3) columns as follows:

CAMERA	MONITOR	DWELL
1	1	2
2	1	2
3	1	2
4	1	2
5	1	2

Sequence programming is best described by going through the above example. To enter the programming mode, press Program Sequence [Prog]. Enter an available sequence number (1 to 60 for this Allegiant model), then press [Enter]. The on-screen monitor display changes to the following format:

1st Line = Camera(Ignore) S0001 L0001 Time(Ignore)

2nd Line = >C0001< M001 D02 Date(Ignore)

The top line of the display always indicates the current step being viewed in the S0001 section. The total length of the sequence is displayed in the L0001 section. When programming a new sequence, the camera number that was being viewed before entering the programming mode is automatically placed between the >< prompts, as in the example C0001 above. Now enter the 1st camera of the sequence into this position. If the camera number is correct, no action is necessary. If not, enter the desired camera number via the keypad and press [Enter].

Using the joystick, move RIGHT one step. The prompts will shift over to the monitor number shown in the example M001. The monitor that was being controlled by the keyboard before entering the programming mode is defaulted to this position. If correct, no action is necessary. If not, enter the desired monitor number via the keypad, and press [Enter].

Move RIGHT again. The prompts now shift over to the dwell time shown in the example D02. The default dwell time for a new sequence is always two (2) seconds. If a different dwell period is desired, change the value to any number between 1 and 60. One line is now complete. Press Next Step [Next] to add a second line. The camera number increments automatically, while the monitor number and dwell remain the same as the first line. Since this line is correct, no change is necessary and Next Step [Next] may be pressed three (3) more times until line five (5) is reached. The joystick can be used to move around within the spreadsheet, but only the Next Step [Next] key can add new lines.

Continue entering camera, monitor, and dwell times in this fashion until finished. If you only want to store the sequence for future use and then exit the programming mode, press Exit / Save [Prog]. Press Exit / Run [Run], to exit the programming mode, store the sequence into memory, and start the sequence running. The switcher steps through the five (5) steps in the order shown, and repeats the sequence when it reaches the last step.

To program a sequence to run once through all its steps and then stop, enter the value 62 for the dwell time in the last step and press [Enter]. The dwell display will change to STP, meaning stop. To program a sequence to run once through all its steps and then unload itself, enter the value 63 for the dwell time in the last step, and press [Enter]. The dwell display will change to ULD, meaning unload.

To edit an existing sequence, press Program Sequence [Prog], enter the existing sequence number, then press [Enter]. You can insert a line into a sequence by navigating down to the line where inserting a new line, and press Insert Step [ON]. A new line identical to the one you are on is added to the next step. To delete a step, navigate to the line to be deleted, and press Delete Current Step [OFF]. To delete all steps below the line you are viewing, press Delete From Here To End [Lock]. (Be careful with this feature!)

It is also possible to erase a sequence: Press Delete From Here To End [Lock] while on the first line of the sequence. Then press Delete Current Step [OFF]. The sequence will be erased, and the programming mode is automatically exited.

Sequence Function Summary

All programming key functions for the LTC 8555 Series are summarized in the following table:

Key	Description
PROG	Selects or terminates program mode
CLEAR	Clears current entry
ENTER	Stores current entry
PREV	Stores entry and move up one step
NEXT	Stores entry and move down one step; add new step if necessary
ON	Insert step before current step
OFF	Delete current step
UP	Move up one step
DOWN	Move down one step, if step already exists
LEFT	Move prompt left one cell
RIGHT	Move prompt right one cell
LOCK	Erase all steps after current step
RUN	Exit, store, load, and run current sequence

Programming a SalvoSwitching Camera Sequence

A SalvoSwitching sequence can be used to switch a group of monitors simultaneously as a synchronized group. To program a Salvo sequence, enter the programming mode as described above for a simple camera sequence. By definition, Salvo sequencing involves more than one monitor. An example of a simple Salvo sequence that switches cameras on three (3) monitors simultaneously is shown below:

CAMERA	MONITOR	DWELL
1	1	SLV
2	2	SLV
3	3	2
7	1	SLV
8	2	SLV
9	3	2
21	1	SLV
22	3	SLV
23	3	2

In general, follow the instructions used for the simple camera sequence (described above), but instead of entering a number of seconds for steps that must switch instantly, enter 61 and press [Enter]. This causes the switcher to automatically change to the salvo abbreviation SLV. Dwell time (in seconds) is entered only when you reach the step containing the last monitor that will be switched within the synchronized group.

17 Keyboard User Functions

17.1 General Information

User functions are keyboard operations which are used infrequently, but provide important system options.

NOTE: Certain functions are restricted to certain user priority levels. Additional information on user priority levels can be found in the See Chapter 14, “User Information,” on page 38. To execute these user functions, select the desired function, and follow the general steps below.

For IntuiKey keyboards, User Functions are accessed using the following procedure:

1. From the main Allegiant screen, press [User Functions] (softkey).
1. Use Previous or Next to navigate to the desired function or press the [Enter User Command] key, enter the desired number, and press [Enter].
2. Press the desired softkey.

For LTC 8555 Series keyboards, User Functions are accessed using the following procedure:

1. Press [User] and verify the indicator lights.
2. Using the numeric keypad, enter the desired User Function number.
3. Press [Enter]. Note that the keyboard camera display shows F followed by the selected function number.
4. Follow the directions for the specific user function (described in its section, herein). In many cases, the joystick is used to select options
5. Press [User] to exit back to normal mode. For example,
USER 2 ENTER

The above example accesses User Function #2 as described below.

These functions are listed in the table shown below.

Fn#	Joystick Up/Down	Joystick Left/Right	Function Description	Pass- word Req.	Access Level		
					1	2-7	8
1	n/a	n/a	Local keyboard test	Y	Y	Y	Y
2	n/a	n/a	Show keyboard port number	Y	Y	Y	Y
3	n/a	n/a	Select keyboard beeper ON/OFF	Y	Y	Y	Y
4	Up/Down	Left/Right	Adjust position of monitor display	Y	Y	N	N
5	Brightness	Msg vs. Stat	Monitor display brightness / status selection	Y	Y	N	N
6	Time/Date ON/OFF	Overlay ON/ OFF	Select monitor display option	Y	Y	N	N
7	Set	Select	Set time	Y	Y	N	N
8	Set	Select	Set date	Y	Y	N	N
9	Set	Select	Set camera ID	Y	N	N	N
10	n/a	n/a	Change user password	Y	Y	Y	Y
11	Select	n/a	Select time/date format	Y	N	N	N
12	n/a	n/a	Default all monitor overlays	Y	N	N	N
13	Select	n/a	Print configuration tables to system printer	Y	N	N	N
14	n/a	n/a	Reserved	-	-	-	-
15	n/a	n/a	Reset system	Y	Y	N	N
16	Select	Enable/Disable	Time event enable/disable	Y	N	N	N
17	Set	Select	Set monitor ID	Y	N	N	N
18	Select	n/a	Print sequence	Y	N	N	N
19	Select	n/a	Select alarm response	Y	Y	N	N
20	Select	n/a	Select printer verbosity	Y	N	N	N
21	Select	n/a	Designate alarm monitor type	Y	Y	N	N
22	Select	n/a	Select control code format (fixed/variable)	Y	N	N	N
23	n/a	n/a	Display CPU software version number	Y	Y	Y	Y
24	Up/Down	Left/Right	Set positions on all monitor displays	Y	Y	N	N
25	Brightness	Msg. vs. Stat.	Brightness/Status select on all monitor displays	Y	Y	N	N
26	Time/Date	Overlay	Set display option on all monitors	Y	Y	N	N
27	Keyboard Log-in	Select	Select keyboard log-in	Y	Y	N	N
28	Console Log-in	Select	Select console log-in	Y	Y	N	N
29	Default Parameters	Select	Default RS-232 parameters	Y	Y	N	N
30	Console Parameters	Select	Set console RS-232 parameters	Y	Y	N	N
31	Printer Parameters	Select	Set printer RS-232 parameters	Y	Y	N	N
32	Alarm Parameters	Select	Set Alarm RS-232 parameters	Y	Y	Y	Y
33	n/a	n/a	Display user number and priority	Y	Y	Y	Y
34	Select	n/a	Camera indicator	Y	N	N	N
35	Camera No.	Enable/Disable	Controllable cameras	Y	N	N	N
36	Select	Enable/Dis- able	Select crosspoint data	Y	N	N	N
37	Select	n/a	R/D addresses mode	Y	N	N	N
38	Select	n/a	Printer port mode	Y	Y	N	N
39	Select	n/a	Select DIU interface port	Y	Y	N	N

Fn#	Joystick Up/Down	Joystick Left/Right	Function Description	Pass- word Req.	Access Level		
40	n/a	n/a	Reserved		-	-	-
41	Select	n/a	Set Satellite Communication Format	Y	Y	N	N
42	Select	n/a	Keyboard log-in auto-off mode	Y	Y	N	N
43	n/a	n/a	CPU battery status		Y	Y	Y
99	Select	n/a	Use functions index		Y	Y	Y

User Function 1 - Local Keyboard Test

User Function 1 can be used as a local test to ensure that all the keyboard LEDs and switches are working. This function automatically calibrates the center position of the analog joystick on LTC 8555 keyboards. Upon entering this test, the keyboard will beep and all LEDs will light for about two (2) seconds. The USER should note if there are any LED failures.

Each key may be pressed to display a unique code number associated with that key. Follow the table below to ensure that all keys are properly being processed by the keyboard. Push [USER] last, as this causes the keyboard to exit the test mode. If the log-on system feature has been selected by the system installer, the same local test may be initiated while the keyboard is not ON LINE by pressing * (STAR).

Key	No.
IRIS UP	044
IRIS DOWN	045
FOCUS UP	042
FOCUS DOWN	043
ZOOM CLOCKWISE1	041
ZOOM COUNTERCLOCKWISE1	040
ALARM	004
USER	000
SEQUENCE	032
HOLD	036
RUN	033
PREVIOUS	035
NEXT	034
#1	010
#2	018
#3	026
#4	011
#5	019
#6	027
CAMERA	024
MONITOR	008
ACKNOWLEDGE	005
PROGRAM	002
SET	001
SHOT	009
OFF	025
ON	017
* (STAR)	016
LOCK	003
#7	012
#8	020

Key	No.
#9	028
CLEAR	037
#0	013
ENTER	029
UP1	052
RIGHT ¹	051
DOWN ¹	050
LEFT ¹	053

¹ Keyboard tests show a speed indicator value in the first digit position when performing pan, tilt, or zoom actions.

User Function 2 - Show Keyboard Port Number

User Function 2 may be used to identify which port a keyboard is plugged into. After entering User Function 2, read the keyboard port number from the monitor display on the keyboard. If using the LTC 8555 Series keyboard, press [User] to exit.

User Function 3 - Select Keyboard Beeper ON/OFF

When User Function 3 is selected, the keyboard user may enable/disable the keyboard audio beeper. If using the LTC 8555 Series keyboard, press [ON] to enable the beeper or [OFF] to disable it. Press [User] to exit. Upon power-up of the keyboard and whenever the Allegiant system undergoes a reset, this setting is set to [ON].

User Function 4 - Adjust Position of Monitor Overlay

User Function 4 allows the characters on the video monitor display to be positioned from the keyboard. Only the display on the monitor that the keyboard is currently connected to is affected. If using the LTC 8555 Series keyboard, use the joystick to position the display as required. Press [Enter] to store the position or [User] to exit.

User Function 5 - Monitor Display Brightness / Status Selection

The white portion of the characters on the video monitor display may be made brighter or dimmer by the User Function 5. Only the display on the monitor that the keyboard is currently connected to is affected. After entering the mode, there are four possible settings. If using the LTC 8555 Series keyboard, moving the joystick up increases the brightness, and moving it down decreases the brightness.

The User Function 5 also permits selection of either the status display or a 12-character monitor message to appear in the first line of the monitor display. The status display indicates alarm, sequence, and lockout information regarding the monitor. The monitor message is a stationary display. This means the display will not change as video is switched from camera to camera on the monitor. After entering the mode, move the joystick left to select monitor message format, and right to select status format. If using LTC 8555 Series keyboard, to exit the mode, press [User].

User Function 6 - Select Monitor Display Option

User Function 6 allows the user to remove the time and date (the left side of the display), or the entire display from the individual monitor. If using the LTC 8555 Series keyboard, move the joystick down to blank the time and date from the screen. This may be desirable when a signal from a DVR with its own time and date is being

used. Move the joystick up to add the time and date back. Move the joystick left to blank the left side portion of the display from the monitor, and right to return it. Refer to User Function 5 to verify brightness level. Press [User] to exit the mode.

User Function 7 - Set Time

User Function 7 enables user setting of the time displayed on all system monitors. After entering the mode, use the joystick to select hours, minutes, or seconds in an edit line (displayed on the monitor screen). If using the LTC 8555 Series keyboard, moving the joystick up or down counts the data item up or down; moving right or left selects between data items. NEXT is used to set the seconds to zero. If [NEXT] is pressed when the seconds are over 30, the minute count (shown on the operating clock display) is incremented. If [NEXT] is pressed when the seconds are under 30, the minutes are left unaffected. Press [Enter] to update the time displayed on all system monitors, and press [User] to exit the mode.

User Function 8 - Set Date

User Function 8 enables the user to set the date displayed on all system monitors. If using the LTC 8555 Series keyboard, use the joystick to select the day, month, or year in an edit line (displayed on the monitor screen). Move the joystick up or down to count the data item up or down; move right or left selects between the data items. If using the LTC 8555 Series keyboard, press [Enter] to update the date displayed on all system monitors. Press [User] to exit the mode.

User Function 9 - Set Camera ID

User Function 9 permits entry of a 16-character camera identification message. This message appears on the video monitor display whenever the specific camera is called up for viewing. If desired, this message can be used to identify the particular scene being viewed. See Chapter 19, "Character ROM Tables for LTC 8500," on page 68 for the various characters available. After entering the mode, users with priority level 1 can use the joystick to move right or left to select the character to be changed. The selected character will be identified by a box with a question mark inside it. The first line of the video monitor screen indicates the code number of the character selected. Move the joystick up or down to step through the Character ROM Table, or enter the character's number (as identified in the tables) via the numeric keypad, and press [Enter]. Once the title has been set, press [Enter] to store it to memory. If using the LTC 8555 Series keyboard, press [User] to exit the mode.

User Function 10 - Change USER Password

User Function 10 is used to change an operator's keyboard log-on access password. This feature is only required in systems where the system installer has enabled the keyboard log-in security feature. After entering the mode, the video monitor display prompts for the current password OLD PASSWORD. Enter the current user password via the numeric keypad, and press [Enter]. If the system does not accept the old password, the system remains at this prompt. If the entered password is valid, the display changes to the NEW PASSWORD prompt for entry of the new password (up to six (6) numerals) via the numeric keypad, then press [Enter]. Leave this step blank if no password is desired. If none is used, at log-on, press [Enter] at the P prompt. To safeguard against typographical errors, the system prompts VERIFY PASSWORD requiring reentry of the new password. If the entered passwords do not agree, the system prompts for reentry and verification of the new password. If the two password entries agree, the video monitor prompt indicates PASSWORD UPDATED.

Press [User] to exit the mode.

User Function 11 - Select Time / Date Format

User Function 11 is used to set the time and date format used throughout the system. The two (2) formats of time available are - 12-hour mode and 24-hour mode. The date is available in a MM-DD-YY format (U.S.), a DD-MM-YY format (International), and a YY-MM-DD format (Asian). After entering the mode, move the joystick up or down to select the desired format. If using the LTC 8555 Series keyboard, press [Enter] to convert the system to the format chosen, then press [User] to exit the mode.

User Function 12 - Default All Monitor Overlays

User Function 12 is used to reset all monitor overlays to default characteristics; bottom center of screen, and full brightness. After entering the mode, press [Enter] to reset all monitor overlays. If using the LTC 8555 Series keyboard, press [User] to exit.

User Function 13 - Print System Configuration Tables

Use this function to print the contents of the various system configuration tables. Move the joystick up and down to select a table, then press [Enter] to send it to the printer port. If using the LTC 8555 Series keyboard, press [User] to exit.

User Function 14 - Reserved Function

User Function 15 - System Reset

The system may be reset from the keyboard. After entering this mode, the video monitor screen indicates RESET SYSTEM. Enter the password via the numeric keypad, and press [Enter]. The system will then reset. If using the LTC 8555 Series keyboard, press [User] to exit the mode without resetting the system.

NOTE: The system should be reset whenever a change is made on the main CPU module's DIP switches. Alternatively, the main power to the CPU bay may be switched off for ten (10) seconds, then restored. Depending on the size and complexity of the system, several seconds may be required before operation is restored. This time is due to the amount of initialization tasks being performed, and is considered normal.

User Function 16 - Time Event Enable/Disable

Use this function to enable or disable any of the programmed time event functions. Up to 64 time event functions can be programmed with the optional LTC 8059/00 MCS, or the LTC 8850/00 GUI Software. Moving the joystick up and down steps through a table of the 64 time events. If an event has been programmed, moving the joystick to the right enables the event, and to the left disables it. The current status of an enabled time event is displayed by this user function.

User Function 17 - Set Monitor ID

User Function 17 is used to enter a (12-character) monitor identification message for display in the top line of the monitor overlay display on any system monitor(s). This monitor title will be visible on the display regardless of the camera currently being viewed. This message can be used to identify the particular monitor or a group of cameras assigned to this monitor. See Chapter 19, "Character ROM Tables for LTC 8500," on page 68 for the available characters.

After entering the mode, the joystick is moved right or left to select the character to be changed. The selected character is identified by a box with a question mark inside it. The first line of the video monitor display indicates the code number of the character selected. Move the joystick up or down to step through the Character ROM Table, or enter the character's number identified in the tables via the numeric keypad, then press [Enter]. Once the monitor title has been set, press [Enter] to store it to memory. If using the LTC 8555 Series keyboard, press [User] to exit the mode. The user may select between this monitor message and the status display by using the User 5 Function described above.

User Function 18 - Print Sequence

Use this function to print the contents of a programmed sequence. Use the joystick to select the desired sequence, then press [Enter] to print it to the printer port. Only those sequences currently existing in memory will be shown in the list. If using the LTC 8555 Series keyboard, press [User] to exit.

User Function 19 - Select Alarm Response

Use this function to reset the system alarm configuration tables to one of these predefined alarm response modes: BASIC, AUTOBUILD, or SEQUENCE & DISPLAY. Move the joystick up or down to select the desired mode, then enter your user password on the numeric keypad. Press [Enter] to update the alarm system. If using the LTC 8555 Series keyboard, press [User] to exit.

NOTE Existing alarm configuration data will be lost when mode is changed.

User Function 20 - Select Printer Verbosity

Use this function to select between print modes; Limited Printing and Full Printing. This selection determines the amount of information printed during alarm processing. Both modes print alarm activation and deactivation messages, but Full Printing goes into much more detail. Use the joystick to select the desired mode, then press [Enter]. If using the LTC 8555 Series keyboard, press [User] to exit without changing the print mode.

User Function 21 - Designate Alarm Monitor Type

Use this function to designate the monitor currently controlled by the keyboard as either a STEP monitor or a REVIEW monitor. This function can only be used in the predefined SEQUENCE & DISPLAY alarm response mode (see ALARM INFORMATION section) to select which monitor is the STEP (also called SEQUENCE) monitor, and which is the REVIEW (also called DISPLAY) monitor. To designate a monitor as the STEP or REVIEW monitor, enter User Function 21, then move the joystick up or down to select the monitor type. Enter your password on the keyboard and press [Enter]. If using the LTC 8555 Series keyboard, press [User] to exit. After selecting new STEP and REVIEW monitors, the previous ones may be disarmed (Arm/Disarm Monitor instructions).

User Function 22 - Select Control Code Format

This function designates whether variable speed pan/tilt and zoom commands are enabled (Factory Default Setting). In most cases, there is no need to disable this function. Move the joystick up or down to select the desired setting, then press [Enter]. If using the LTC 8555 Series keyboard, press [User] to exit.

User Function 23 - Display CPU Software Version Number

Use this function to display the revision number of the Allegiant's CPU software on the monitor screen.

User Function 24 - Set Positions on All Monitor Displays

This function is similar to User Function 4, except it changes the monitor display positions of all monitors in the system. After entering User Function 24, use the joystick to position the display as required on the monitor controlled by the keyboard. Press [Enter] to store and change all system monitor displays to this position. If using the LTC 8555 Series keyboard, press [User] to exit.

User Function 25 - Set Brightness on All Monitor Displays

This function is similar to User Function 5, except it changes the monitor display brightness of all monitors in the system. The white portion of the characters on the video monitor displays may be made brighter or dimmer via the User Function 25. Move the joystick up to increase brightness, or down to decrease brightness. Once the display on the monitor that the keyboard is currently controlling is adjusted, press [Enter] to change all system monitors to the same setting. Press [User] to exit the mode.

The User Function 25 mode can also select either the status display or a 12-character monitor message to appear in the first line of the monitor display. The status display indicates alarm, sequence, and lockout information regarding the monitor. The monitor message is a stationary display; the display will not change as video is switched from camera to camera on the monitor. After entering the mode, move the joystick left to select the monitor message format, or right to select the status format on the monitor the keyboard is controlling. Press [Enter] to change all system monitors to the same setting. If using the LTC 8555 Series keyboard, press [User] to exit.

User Function 26 - Set Display Option On All Monitors

This function is similar to User Function 6, except it selects the monitor display option of all monitors in the system. The User Function 26 mode allows removal of the time and date, the left side of the display, or to remove the entire display from the system monitors. Move the joystick down to blank the time and date from the screen. This is sometimes desirable when a DVR with its own time and date is being used as a video source. Move the joystick up to add the time and date back again. Move the joystick left to blank the left side of the display from the monitor and right to return it. Refer to User Function 5 or 25 to verify brightness level. Press [Enter] to update all system monitors to the selected format. If using the LTC 8555 Series keyboard, press [User] to exit.

User Function 27 - Select Keyboard Log-in

This function controls the system's keyboard log-in feature. Move the joystick up or down to select the mode for the system to function in. If the log-in feature is enabled (MUST USE KBD PWD is selected), the system keyboards require each user to log-in and log-off the system. All users are required to enter a user number and correct password to interact with the system. If the log-in feature is disabled (NO KBD PWD LOGIN is selected), system keyboards are always online with the system. Once selection is made, exit the User Function mode and reset the system either via keyboard User Function 15, or by removing and restoring the main AC power to the system. Once the system has been reset, the keyboard log-in function will be active and all system keyboards will need to be logged-in to access the system.

User Function 28 - Select Console Log-in

This function controls the system's external console port log-in feature. After entering the mode, move the joystick up or down to select the mode in which the system should function. If the log-in feature is enabled (MUST USE CON PWD is selected), any external PC or other computing device will be required to log-in to communicate with the system. External computing devices are required to enter a user number and correct password. If the console log-in feature is disabled (NO CON PWD LOGIN is selected), the console port is available for communication.

Once the selection is made, exit the User Function mode and reset the system, either via keyboard User Function 15 or by removing and restoring the main AC power to the system. Once the system has been reset, the console log-in function is active, and all external computing devices need to log-in to access the system.

User Function 29 - Reset RS-232 Parameters to Default

This function returns the system's external RS-232 ports to a known default state. After entering the mode, enter a valid password. The system will reset after placing the RS-232 protocols back to the default state. See Chapter 13, "Factory Default Settings," on page 33 for additional information.

User Function 30 - Set Console RS-232 Parameters

This function is used to set the RS-232 baud rate and handshake options for the system's console port. Upon entry to this mode, the current settings are displayed. Move the joystick up/down to select the baud rate, and left/right to select the handshake option. After being changed, the port is also automatically set to eight data bits, no parity, and one stop bit. Once new settings have been selected, enter the user password and press [Enter]. If using the LTC 8555 Series keyboard, press [User] to exit.

User Function 31 - Set Printer RS-232 Parameters

This function is used to set the RS-232 baud rate and handshake options for the system's printer port. Upon entry to the mode, the current settings are displayed. Move the joystick up/down to select the baud rate, and left/right to select the handshake option. After being changed, the port is also automatically set to eight data bits, no parity, and one stop bit. Once new settings have been selected, enter the user password and press [Enter]. If using the LTC 8555 Series keyboard, press [User] to exit.

User Function 32 - Set Alarm RS-232 Parameters

Use this function to select the RS-232 baud rate and handshake options for the system's alarm port. Upon first entering the mode, the current settings will be displayed. Moving the joystick up/down selects the baud rate. Moving the joystick left/right selects the handshake option. After being changed, the port is also automatically set to eight (8) data bits, no parity, and one stop bit. Once the new settings have been selected, enter the user password and press [Enter]. Press [User] to exit the mode.

User Function 33 - Display User Number and Priority

This function displays the current user's number and priority level on the monitor screen. The user number will be displayed on the top line and the user's priority level will be displayed on the bottom line of the monitor screen. If using the LTC 8555 Series keyboard, press [User] to exit.

User Function 34 - Camera Indicator

This function is used to enable an onscreen indicator to identify a pan/tilt equipped camera. Move the joystick up or down to select DISP CAM CONTROL or NO CAM CONTRL DISPL. Press [Enter] to activate your selection. When enabled, cameras identified as controllable (via User Function 35 or the optional LTC 8059/00 MCS package), show a ◀▶ in the middle of the first line of monitor text.

User Function 35 - Controllable Cameras

Priority 1 users can use this function to select camera sites equipped with pan/tilt devices. Move the joystick up or down to select the camera number, and left or right to select FIXED or MOVABLE. User Function 34 or the optional PC software package enables or disables the display of the controllable camera indicators on the system monitor displays.

User Function 36 - Select Crosspoint Data

Use this function to select options for accessory device data that can be sent out the biphas control port. Move the joystick up or down to select XPOINT DATA, ALARM XPOINT, or PHYSICAL CAMERA NUMBER, and left or right to enable/disable the selected option. These options are typically applicable only when LTC 8770 Series Switcher Follower accessory devices are being used in the system.

User Function 37 - R/D Address Mode

Priority 1 users can use this function to select whether the biphas control data commands will be addressed using the cameras' logical numbers or physical number indexes in the Camera Table. Move the joystick up or down to select LOGICAL or PHYSICAL and press [Enter] to activate your selection. If this option is set to LOGICAL, AutoDome Series cameras and Allegiant Series receiver/drivers should be addressed using the cameras' logical identification number. If it is set to PHYSICAL, the devices should be addressed using the cameras' physical port number.

User Function 38 - Printer Port Mode

This function allows configuration of the system's PRINTER port for use with a LTC 8712 Series Console Port Expander accessory device. Move the joystick up or down to select the printer port function; NORMAL or EXPANDED. Press [Enter] to activate your selection. Reset the system for this setting to take effect.

User Function 39 - Select DIU Interface Port

Use this function to select the switcher's interface port to be connected to an external LTC 8016/90 Allegiant Bilinx Data Interface accessory unit. Move the joystick up or down until the desired port for use as a data interface (DIU) is displayed. Press [Enter] to configure the port. If using the LTC 8555 keyboard, press [User] to exit the mode.

User Function 40 - Reserved Function

User Function 41 - Set Satellite Communication Format

This function provides three (3) configuration options that determine the behavior and content of the data commands issued by a master system to a satellite system. In most cases, it is only necessary to change the default setting if using a multi-level cas-

caded Allegiant satellite system configuration. (see Section Appendix A “Satellite Systems,” on page 78 for more information on satellite system configurations.)

Detailed descriptions of these options are listed below.

After entering the mode, move the joystick up or down to select the desired option. Enter a valid user password, and press [Enter].

- **CACHE REM CAM** option (default factory setting). In this mode, satellite commands are issued repetitively, regardless of whether the satellite camera is still being viewed by an operator. This mode of operation is more desirable in standard systems because it minimizes delays when previous satellite cameras are reselected. It is not recommended for use in cascaded systems. In cascaded systems, this mode could result in all available trunk lines coming from the 3rd level satellite system to become used up, making them unavailable to the operators at the intermediate system.
- **NO REM CAM CACHE** option. In this mode, after the top level operator selects a locally connected camera, the trunk line between the top level and the intermediate level system will immediately be reset to its start-up camera (as defined in the Monitor Table of the LTC 8059/00 MCS). This in turn frees up the trunk line between the intermediate level system and the 3rd level system so it will be available if needed by an operator at the intermediate level system.

In addition, this option changes the behavior of how the system determines which trunk line to use. When this option is not used, a new trunk line (if available) will be used for each camera selection. When this option is enabled, an operator's monitor will use the same trunk from the same bay as different cameras are selected, as long as no other operator is viewing the same satellite camera. In 3-tier cascaded satellite systems, this feature minimizes the use of trunk lines by the top level Master system. This is especially advantageous when the operator at the Master site is viewing cameras from the 3rd level satellite. Since this will result in less trunk lines being used up, the intermediate Master/Satellite system will have more access to trunk lines from the 3rd level satellite.

- **SAT nnn PRIORITY** option. If the top level master system and intermediate level system in a cascade configuration can or will be set to operate as “Dual Master” systems, a priority based satellite camera selection feature can be configured. In a default cascaded satellite system configuration, satellite switching commands are not associated with a user priority level. When a switching command sent from a master site is received by a satellite, the switch selection can immediately be overridden by operators at the satellite location having any priority level. This situation is more likely to be encountered in 3-tier satellite systems that do not have a good distribution of trunk lines (i.e., more between the top level system and the intermediate level system than there are between the intermediate system and the 3rd tier satellite).

Since dual master configurations support bi-directional communications, selecting the **SAT nnn PRIORITY** option for both the top level and intermediate level master systems will result in the generation of priority based satellite commands.

The satellite number assigned to the system that is currently being programmed must be specified for the nnn value. This feature will enable use of the operator's user priority to determine if access to a desired satellite camera is provided or not. For instance, if no trunk lines are available and an operator requesting a satellite camera has higher priority than at least 1 of the existing operators, the requested camera will be switched. If the operator does not have sufficient pri-

ority, they will receive an error message (i.e., error 81) via the satellite communication path, and their camera will switch to the start-up camera specified in the Monitor Table.

In addition, the same behavior for selecting trunk lines as described in the NO REM CAM CACHE option is applicable to this option. An operator's monitor will use the same trunk from the same bay as different cameras are selected, as long as no other operator is viewing the same satellite camera.

User Function 42 - Keyboard Log-in Auto-off Mode

Priority 1 users can use this function to select a keyboard log-off feature to automatically log a keyboard off after a pre-selected time of inactivity. After entering the mode, move the joystick up or down to select the desired time period. Enter a valid password, and press [Enter]. If using the LTC 8555 keyboard, press [User] to exit the mode.

User Function 43 - CPU Battery Status

Use this function to view the condition of the batteries used to backup CPU memory. Once the function is entered, the condition is displayed on the monitor text display. If using the LTC 8555 keyboard, press [User] to exit the mode.

User Function 99 - User Function Index

This function is an index listing of all Keyboard User Functions. Move the joystick up or down to view an abbreviated description of the function number currently shown in the first line of the monitor display. Only those functions available to the user (based on their priority level) will be displayed.

18 Maintenance Information

The Allegiant system has been designed to perform for long periods of time with little or no maintenance. Occasionally the need will arise to clean the keyboard, or replace a fuse. Follow the instructions below if any of these items are required.

18.1 Cleaning the Keyboard

The keyboard may be cleaned whenever deemed necessary simply by temporarily removing it from the system and wiping it with a damp cloth. If a conventional spray type cleaner is required, spray the cloth first, then wipe off the surfaces. Do not use petroleum based cleaners or cleaners containing benzene, trichlorethylene, ammonia or acetone, as these cleaners could damage the plastic surfaces.

18.2 AC Line Voltage Input Selection

The AC line voltage input selector is found on the rear of the equipment bay inside the line cord connector housing. The present input voltage selection will be shown in the window of the connector housing. Remove AC line cord if the setting is incorrect. To change the setting, insert a flat blade screwdriver into the slot located at one end of the connector housing as indicated in the drawing and rotate the screwdriver until the door to the housing opens.

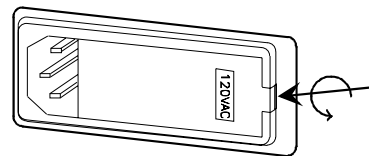

Figure 12: AC line voltage input connector

Remove the voltage selector wheel from the connector housing and rotate until the desired voltage is visible.

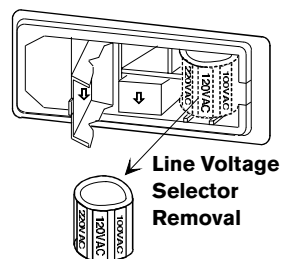

Figure 13: Line voltage selector

Reinsert the wheel back into the connector housing so that the selected voltage is facing out. Snap door closed and verify that the correct voltage selection is visible through the window. Reattach AC line cord.

18.3 AC Line Fuse Replacement

The AC line fuse on Allegiant power supply models is found on the rear of the equipment bay near the line cord connector. Power supply models for 220-240 VAC input version may contain a circuit breaker equipped power switch which can be reset directly from the front. If the line fuse needs to be replaced in a 120 VAC model power supply, remove the line cord from the system. Insert a flat blade screwdriver into the slot located at one end of the connector housing and rotate the screwdriver until the door to the housing opens. Remove fuse holder from housing as shown in drawing.

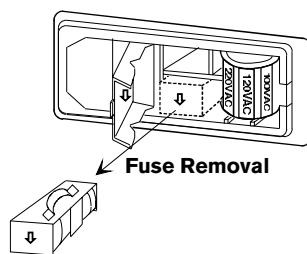

Figure 14: Allegiant power supply AC line fuse

Remove fuse from holder and replace with fuse of same rating for continued protection. Reinstall fuse holder into connector housing in the same orientation as indicated by the arrow on the door cover. Snap door closed. After replacing fuse, verify system start-up and operation.

18.4 Power Supply Fuse Replacement

The main power supply is located in the far right side of the equipment bay. Remove the front panel of the bay by loosening the four fasteners. Locate the fuse to be replaced by observing the green LED indicators. Note which LED indicators are not lit, then turn OFF the main power switch located on the power supply. Replace fuses associated with LEDs which were not lit. Switch on the main power switch and verify that all LEDs are now lit. Replace front panel.

18.5 Replacement of Memory Backup Batteries

CAUTION Lithium batteries should be replaced by qualified service personnel only.

The memory backup batteries are located on the main CPU card located next to the power supply module in the main CPU bay. The batteries provide RAM memory backup for a period of at least one year. They are only active when main AC power to the system has been lost. The RAM memory is used to store system operational data which is frequently changing, including time/date and system crosspoint data (i.e., which camera is currently being displayed on which monitor). More vital system data such as camera titles, alarm settings, user information and passwords, etc. is stored in non-volatile memory that is not affected by the condition of the batteries or the main AC power.

Remove the front panel of the main CPU bay by loosening the four fasteners. The two batteries are mounted on the front edge of the CPU card and are about 25 mm (1 in.) in diameter. Insert a small flat blade screwdriver into the slot on one of the

Replacement of Memory Backup Batteries

battery holder sockets and gently pry the battery from the holder until it can be removed by your fingers. Replace old battery with new battery by lifting the retaining clip up while inserting the battery into the socket. Insure that the negative side of the battery contacts the socket by seating the battery until it is somewhat flush with the level of the battery holder. Repeat procedure for other battery.

Verification of the system's time and date and sequence programming should be made to insure no information was lost. Refer to the appropriate section of the instruction manual if any reprogramming is required.

		‡	!!	¶	§		‡	↑	↓	→	←		↔		
192	193	194	195	196	197	198	199	200	201	202	203	204	205		
<u>st</u>	<u>nd</u>	<u>rd</u>	<u>th</u>	R D	R M	S T	F								
208	209	210	211	212	213	214	215								
α	β	Γ	π	Σ	σ	μ	τ	ϕ	θ	Ω	δ	ω	φ	€	∩
224	225	226	227	228	229	230	231	232	233	234	235	236	237	238	239
≡	±	≥	≤	∫	J	÷	≈	°	.	.	√	∞	z	■	
240	241	242	243	244	245	246	247	248	249	250	251	252	253	254	255

Figure 15: LTC 8500 Character ROM Table

20 Error Messages

- **Error 01 - Invalid camera request**

The camera number entered from the keyboard does not exist. If using the optional LTC 8850 GUI Software or the optional LTC 8059 MCS, make sure the number exists in the Camera Identification Table. Download the table to be sure.
- **Error 02 - Invalid monitor request**

The monitor number entered from the keyboard does not exist. Enter a valid monitor number.
- **Error 03 - Locked remote device**

The remote device requested cannot be controlled because it is locked by a user with equal or higher priority. Check with the other users or request that a higher priority user unlock the remote device.
- **Error 04 - Monitor locked**

The monitor requested cannot be accessed because it is locked by a user with equal or higher priority. Check with the other users or request that a higher priority user unlock the monitor.
- **Error 05 - Remote device access restricted**

Remote locked out by Remote Lockout Table.
- **Error 06 - Monitor Access Restricted**

Monitor locked out by Monitor Lockout Table.
- **Error 10 - Access denied**

A function was requested that requires a higher user priority. Only a Priority 2 user or a supervisor with Priority 1 may access this function.
- **Error 11 - Access denied**

A function was requested for which your user priority is too low. Only a supervisor with Priority 1 may access this function.
- **Error 15 - Invalid user function**

The function number requested from the keyboard is invalid. Refer to the User Function Table for a listing of the valid user function numbers.
- **Error 20 - Acknowledge denied**

The ACKNOWLEDGE button has been pressed by a user without the authority to acknowledge alarms.
- **Error 21 - Incorrect acknowledge**

In order to properly acknowledge an alarm event, the keyboard must be switched to a monitor that is displaying the alarms.
- **Error 22 - Acknowledge disabled**

Alarms on this monitor can not be acknowledged, because that capability has been disabled by the system programmer.
- **Error 23 - Camera not in alarm**

The camera displayed on the monitor is not an alarm video; only alarm-generated video can be acknowledged.

- **Error 24 - Keyboard not enabled for acknowledge**

This keyboard may not acknowledge alarm video on this monitor; it has been disabled by the system programmer.
- **Error 25 - Alarm switcher running**

Alarm video may only be acknowledged if the alarm switcher is not running; press [HOLD] to stop the switcher.
- **Error 50 - SEQUENCE not available**

The user tried to load a switcher sequence that does not exist. This is a good way to tell from the keyboard which sequence numbers are unused when desiring to add one.
- **Error 51 - SEQUENCE request**

A request was made to load an ABSOLUTE type sequence without the keyboard being on one of the monitors in that sequence. Because inadvertent loading of monitors should be avoided, the user is required to switch his keyboard to one of the monitors used by the sequence. The PROGRAM mode may be used to review what monitors are used in the sequence.
- **Error 52 - SEQUENCE request**

A request was made to load a RELATIVE type sequence on too high of a monitor number; the monitors used by the sequence would extend past the highest monitor. Try switching to a lower monitor number before loading the sequence.
- **Error 53 - Switcher empty**

The user has tried to control a sequence using the NEXT, PREV, RUN, or HOLD keys without there being a sequence loaded.
- **Error 55 - SEQUENCE priority**

The switcher sequence being requested or cleared requires monitors that are in use by a user of equal or higher priority. Contact a user with higher priority or have the system administrator clear the monitors in question.
- **Error 56 - SEQUENCE request**

The user has tried to load a sequence that is being edited in the PROGRAM mode. Once editing is completed, the sequence may be loaded.
- **Error 58 - SEQUENCE request**

The sequence being requested is a relative sequence, and the user is only allowed access to absolute sequences.
- **Error 60 - PROGRAM request**

The user has tried to program a sequence that is currently running. The sequence must first be stopped before any editing can be performed.
- **Error 62 - PROGRAM request**

The user has tried to program a new sequence when the system is out of sequence memory space. Delete unused sequences and then program the new sequence.
- **Error 63 - PROGRAM request**

Some other user is already programming a sequence on this monitor.

- **Error 70 - Monitor not allocated to alarm monitor group**
This monitor can not be used for alarm operations; it has not been designated as alarm-capable by the system programmer.
- **Error 71 - Step monitor required**
A group of alarm monitors may not have an armed Review (display) monitor without having armed Step (sequence) monitors.
- **Error 78 - Must enter alarm number**
A specific alarm number must be entered when arming or disarming an alarm.
- **Error 80 - Trunk not available**
An attempt was made to access a remote camera connected to a satellite system, but no unused trunk lines are currently available. Depending on system configuration and certain user options, the operator's monitor may automatically switch to the default camera programmed into the Start-up column of the Monitor Table when this error occurs.
- **Error 81 - Satellite Trunk Seized**
The camera currently viewed has changed because an operator with a higher priority has selected a different camera that seized the trunk line from the satellite. The operator's monitor will automatically be switched to the default camera programmed into the Start-up column of the Monitor Table.
- **Error 89 - internal stack error**
A stack overflow within the system has occurred. Report this to the manufacturer.
- **Error 90 - Keyboard entry undefined**
The keyboard entry is not defined. Check the appropriate section of the instruction manual for the desired operation and try again.
- **Error 92 - Keyboard entry out of range**
The data entered for a valid command was not in the range allowed by the system. Check the appropriate section of the instruction manual for the acceptable ranges for the command in question and try again.
- **Error 94 - Keyboard entry invalid**
An invalid character has been received from the keyboard. Usually this would indicate a communications error. Verify that the keyboard-to-system cable is not producing an intermittent connection.
- **Error 95 - Keyboard entry incomplete**
The control sequence sent from the keyboard was incomplete. Usually this would indicate a communications error. Verify that the keyboard-to-system cable is not producing an intermittent connection.
- **Error 96 - * (STAR) undefined**
The * key has been pressed, but there is no definition for this button.

21 Troubleshooting Guide

The Allegiant system has been designed to perform reliably for long periods of time. All circuitry consists of state-of-the-art components designed around a modular concept. The modular concept allows quick location and replacement of suspect circuits. If system troubleshooting becomes necessary, follow the guidelines:

21.1 Main Bay Checkout

1. Main power switch is ON and power LED indicator is not lit: Check main line fuse on rear of main bay. Refer to Maintenance Information Section for replacement instructions.
2. Any of the green LED indicators located on the front of the main power supply is out: Replace blown fuses associated with any unit fuse indicators.
3. Green CPU LED indicator in main CPU bay is not blinking and red LED is OFF. Remove power from main bay for ten (10) seconds. Apply power and verify LED is blinking. If not, replace the microprocessor module.

If red LED is lit, replace microprocessor board batteries. Follow procedure outlined in Maintenance Information Section.

4. Intermittent video output or system operation: Verify all circuit card modules are properly seated in their respective rack connectors.
5. Power Supply LEDs lit, but no power indication on modules or accessory devices: Verify proper seating of power supply within the card cage. Verify that supplied retaining screws are installed.

21.2 Keyboard Checkout

1. **No keyboard display indicators:** Check interconnect cable for cut or broken wires between keyboard and main CPU bay. Replace cable if necessary. Relocate keyboard connector on main CPU bay to another keyboard input port. Replace keyboard.
2. **Keyboard indicators lit but keyboard is inoperative:** Verify keyboard is logged-on to the system (if log-on feature has been enabled). Check interconnect cable for cut or broken wires between keyboard and main CPU bay. Replace cable if necessary. Relocate keyboard connector on main CPU bay to another keyboard input port. Replace keyboard.
3. **Limited keyboard functions:** If possible, perform a local keyboard test to verify operation of all keys. See Chapter 14, "User Information," on page 38. If a local test cannot be performed, replace the keyboard.

Users of the optional LTC 8850 GUI Software or the optional LTC 8059 MCS package should refer to lockout tables to determine if problem is related to user restriction tables. If table settings are verified and no discrepancies are found, replace keyboard.

4. **Keyboard Joystick not centered:** If the analog joystick of the system keyboard becomes un-centered due to normal wear, it can be re-calibrated. If using the IntuiKey keyboard, go to the Keyboard Control menu and press [Joystick Auto

Calibrate]. If using the LTC 8555 Series keyboard, refer to the User Function 1 procedure. (See Chapter 14, "User Information," on page 38).

21.3 Video Monitor Display Checkout

1. **No video display on any monitor:** Verify proper CPU operation as described above under Main Bay Checkout Section.
2. **No video display on some monitors:** Verify operational camera is selected on suspect monitors. Confirm monitor is operational. Check monitor coax connections. Verify coax connection to correct monitor output on rear of main bay. Replace video output module.
3. **Poor video on monitor:** Check monitor for proper termination. Check operation of known good camera directly to monitor.
4. **Partial or no on-screen alphanumeric display:** Check user selectable brightness feature (via USER 5 keyboard function) and then verify alphanumeric display has been enabled (via USER 6 keyboard function). Position the overlay with USER 4 function.
5. **Time and Date portion of the on-screen display alternates with "?? ?? ??", and the LED on the front panel indicates a low battery condition:** Replace CPU batteries.

21.4 Remote Receiver/Driver Functions Inoperative

1. **All receiver / drivers and functions inoperative:** Verify power LED indicator on Signal Distribution Unit is lit. If not, check fuses on front of main CPU bay power supply. Verify the Code LED indicator flickers when control is activated by the keyboard. If not, replace Signal Distribution Unit.
2. **Individual receiver/driver non-operative:** Check green LED indicator on fuse bracket in receiver/driver box. This signifies that AC power is applied by the keyboard. If not, check shielded-twisted-pair cable between Signal Distribution Unit and receiver/driver box. Confirm camera address setting in receiver/driver corresponds to same camera number as selected by the keyboard. Perform internal receiver/driver local test to verify operation of receiver/driver circuitry and pan/tilt/zoom wiring.
3. **AutoDome series dome cameras are not operating in a variable speed fashion:** Verify CPU DIP switch 7 is selected for variable speed mode.

21.5 No Alarm Response

1. **No system alarms operative:** Verify power LED indicator on Alarm Interface Unit is lit. If not, check fuses on front of main CPU bay power supply. Verify the Alarm LED indicator lights and the audible buzzer sounds (if enabled) only when an 'alarm' is applied to the unit. If not, replace Alarm Interface unit.
2. **Individual cameras/monitors not responding when alarmed:** Ensure desired cameras are properly armed on the appropriate armed monitors in the system. Verify alarming device and cable to Alarm Interface unit intact.

3. **Incorrect system alarm response:** Verify that the desired alarm response mode has been selected. Refer to the section on Select User Functions for instructions.

21.6 CPU Software Version Numbers

During the evolution of the system, there have been various CPU software versions released. In certain troubleshooting cases, Factory Technical Support personnel may ask for the version of the CPU. If it becomes necessary to obtain a CPU software version number, follow the steps below:

CPUs supplied in systems sold after 1995:

1. Using a system keyboard, an operator with a level 1 priority can enter keyboard User Function 23. Press the [User] key. Enter 23 using the numeric keypad, then press the [Enter] key.
2. The CPU version numbers will be displayed on the overlay of the monitor currently being controlled by the keyboard. Record number for future reference.

Very Old or current CPU Versions:

1. Remove the front panel of the main CPU bay by loosening the four corner fasteners.
2. Turn OFF main AC power switch on power supply.
3. The CPU module is located next to the power supply. Pull out CPU module from the card cage until IC's containing white labels are visible. The white labels contain copyright information and software version numbers. Record all numbers from label for future reference.
4. Re-install the CPU module and switch ON main AC power.
5. Re-attach front panel.

22 Glossary of Terms

Auxiliary

An auxiliary is an additional function of the remote receiver/driver which permits on/off control of outputs available to the user. In the Allegiant system, there are four relay outputs available which can be configured for contact closures, 24 VAC output, or LINE voltage output. They can also be set to activate either momentarily or in a latching mode.

Command Script

A unique feature of the Allegiant system wherein a section of nonvolatile memory can be used to store specialized user-defined programming. A program of this type could then provide custom features which ordinarily would not be obtainable.

Dither

A receiver/driver feature which provides added protection to very low light level cameras by periodically panning a few degrees left and right automatically.

Lockouts

The ability of a switcher/controller system to restrict access of operations to certain system functions or features. The Allegiant system has two modes of lockouts. The first mode is based on operator priority level. This allows a higher priority level operator to lockout lower level operators from either viewing or controlling specific cameras. The second mode involves LTC 8059 MCS setups which can:

- Restrict operators/keyboards from viewing/accessing any camera.
- Restrict operators/keyboards from controlling/accessing any pan/tilt.
- Restrict operators from using certain keyboards.
- Restrict operators/keyboards from accessing certain monitors.

Log-on, Log-off

A selectable feature of the Allegiant system which requires operators to enter a user number and an optional password into the keyboard prior to having access to system operations.

Matrix Switching

The ability of a switching system to display any camera on any monitor or the same camera on all monitors.

Phased Cameras

Properly integrated cameras which give a roll-free video display when switching from one camera to the next in a sequential switcher system. Phased cameras are the result of line-locked cameras being powered from the same AC power, externally synchronized, or vertically phased adjusted on cameras equipped with this option.

Pre-position

The ability to store the position of a pan/tilt and zoom lens so that the same desired scene can be later recalled automatically. With the Allegiant system, there can be multiple preset scenes stored for each pan/tilt camera. For each scene, the pan, tilt, zoom, and focus settings are stored.

SalvoSwitching

The ability of the Allegiant system to switch multiple video monitors as a synchronized group. Since multiple monitors switch together, the operator can view multiple scenes of a specific area or zone before switching to the next area.

Sequence

A series of camera scenes that can be preprogrammed to automatically switch. The Allegiant system can store up to 60 separate sequences, with each one capable of having a random camera order, individual camera dwell times, and SalvoSwitching steps.

Time Event

An Allegiant system feature (available with the LTC 8850 GUI Software or the LTC 8059 MCS) that enables various system functions to be periodically activated automatically. Event functions such as monitor message broadcasts, sequence and switching operations, receiver/driver actions, message printing, alarm settings, and execution of custom factory programming can be stored in the system memory to be executed at a pre-determined time. The task can be specified to begin on a specific year, month, day, and time, and can be programmed to repeat at intervals ranging from every five minutes up to a year.

Vertical Interval Switching

Vertical Interval switching is a method of switching video from camera to camera during the vertical blanking interval period of the video signal. This minimizes visual switching disturbances such as rolling, jitter, video flashes, etc. and eliminates frame information loss when used with VCR machines.

Appendix A Satellite Systems

A satellite system configuration is usually used for a medium to large distributed system, or to obtain extremely large matrix sizes configured more conventionally. Typically, a single Main control site can be used to view/control cameras located both locally and at various remote satellite sites. Since up to 256 satellite sites can be linked to a single Main control site, very large, distributed systems can be achieved. If the satellite systems are located at the same site as the Main system, the result is a large conventional-type system.

In a satellite configuration, the Main control site can view/control any camera in the entire system, but the remote satellite sites can only view/control cameras associated with their own site. Satellites may be configured to operate either independently or, with no local viewing/control capability.

It is also possible to configure satellite systems where each site can view/control cameras from anywhere in the system. For a two (2) site system, this is referred to as a dual master configuration. In the same manner, triple and quadruple master system configurations can also be configured. Cascaded satellite systems, where a Main site has a satellite which is a master to another satellite is another available scenario. In fact, it is possible to configure systems that include a mixture of any or all of the above scenarios.

Allegiant Satellite Concepts

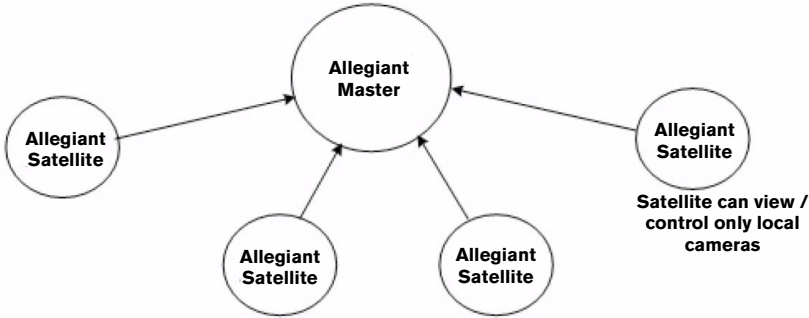

Typical Master / Multiple Satellite Configuration

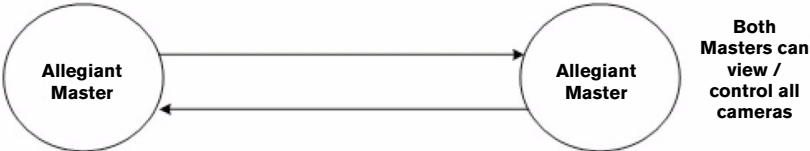

Dual Master Configuration

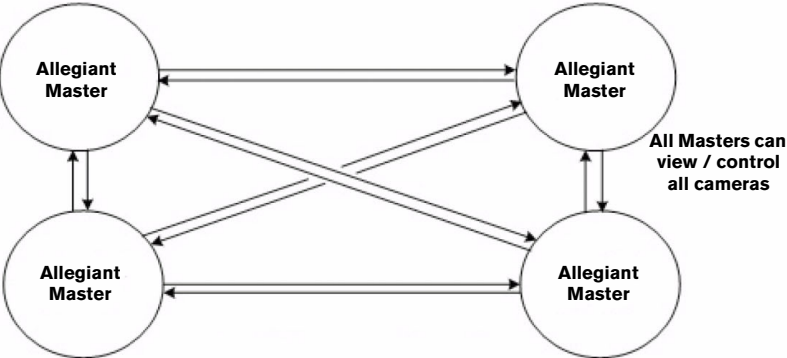

Quadruple Master Configuration



Satellite / Master can view / control local and Satellite's cameras
'Cascaded' Satellite Configuration

Figure 16: Possible Allegiant Satellite System Configurations

Any Allegiant Series switcher model (LTC 8100, LTC 8200, LTC 8300, LTC 8500, LTC 8600, LTC 8800, or LTC 8900) can be used as a main site or a satellite site unit. All products are standard models, and the only special requirement is to use either the optional LTC 8059/00 MCS or the optional LTC 8850/00 GUI Software package for initial programming of each Allegiant system.

An Allegiant biphas control data line from the code distribution unit at the Main site must be provided to each satellite site. This data line carries all pan/tilt/zoom control commands, in addition to the switching commands generated by the Main

site switcher. The control data line should be connected to a LTC 8780 Series Data Converter to provide address decoding functions for the satellite site. If operators at the satellite site are permitted to control pan/tilt/zoom-equipped cameras, a LTC 8569 Series Code Merger must be installed at the satellite site. The Code Merger combines code generated by the main site and the satellite site, so both sites have control over pan/tilt/zoom-equipped cameras located at the satellite site. The LTC 8780 Series unit can then be connected to one of the data outputs of the LTC 8569 Series unit.

One or more monitor outputs from each satellite system are used as video trunk lines to link the remote sites to the Main site. The number of trunk lines from a satellite site determines the maximum number of cameras from that site that may be viewed simultaneously at the Main site. A satellite switcher model must be selected so that it provides the desired number of local monitor outputs plus the number of monitor outputs that will be used as trunk lines.

The Main site switcher must include sufficient camera inputs for local cameras plus trunk lines. The maximum physical number of camera inputs or monitor outputs used as trunk lines cannot exceed the capacity of the system. A single Main site switcher can control multiple satellite sites up to its video input limit. If full matrix switching is required at the Main site, the number of trunk lines from each satellite site must equal the number of monitors connected to the Main site switcher. Multiple independently controlled Main site systems can be combined to provide large numbers of monitor outputs at the Main site. System capacities are listed below:

System Type	Max. Camera Inputs	Max. Monitor Outputs	Max. No. of Satellite Sites
LTC 8100 Series	8	2	8
LTC 8200 Series	16	5	16
LTC 8300 Series	32	6	32
LTC 8500 Series	64	8	64
LTC 8600 Series	128	16	128
LTC 8800 Series	256	64	256
LTC 8900 Series	4096	512	256

Since Main site Allegiant Series switchers support access to a large quantity of remote satellite cameras, they provide additional logical camera numbers for identifying the location of the satellite camera inputs in the system. These logical camera numbers can also include titles which would appear on the Main site's monitors for any remote cameras. Since each camera (anywhere in the system) must have a unique camera number, logical camera numbers together with physical camera inputs make up the total system camera capacity. Thus, there is a trade-off between the total number of Main site cameras and the number of inputs used as trunk lines.

The more inputs used as trunk lines, the fewer there are for use as direct camera inputs.

Model No.	Maximum Number System Cameras*
LTC 8100 Series	264
LTC 8200 Series	272
LTC 8300 Series	288
LTC 8500 Series	320
LTC 8600 Series	1152
LTC 8800 Series	2304
LTC 8900 Series	4608

***Camera inputs at all sites, plus trunk lines.**

The Main site system must be programmed via the MCS LTC 8059/00 or the LTC 8850/00 GUI to identify camera trunk line inputs as well as remote satellite cameras. All systems must be configured with no duplicate camera numbers anywhere in the system. The installer should verify that the camera numbers programmed into the Start-up Camera field of the Monitor Table are suitable for viewing by respective operators. If there are Lockouts programmed into the system, specifying a neutral camera would prevent the situation where a restricted camera could be switched to a restricted operator's monitor when their trunk line is stolen. For this feature to operate properly, the start-up camera numbers must be locally connected cameras or a local unused input (i.e., the raster generator will be displayed when called-up).

In addition, it is recommended to program Lockouts for all system keyboards so that they do not have access to unused monitor outputs. This prevents operators from inadvertently selecting a satellite camera on a non-existent monitor which will result in a trunk link becoming used up, possibly making less trunk lines available for valid selections.

Keyboard User Function 41 (See Chapter 14, "User Information," on page 38) offers additional programming options if a multi-level cascaded Allegiant satellite system configuration is being used.

Any alarm inputs to the Main site configured to activate satellite cameras operate normally except when limited by the number of available trunk lines. The software automatically determines trunk usage, depending on the priority level of operators currently viewing satellite cameras.

Alarm inputs applied at a satellite site will NOT activate alarm video at the Main site. If the application requires alarms located at a satellite to activate video at the Main site, the Main site's LTC 8540/00 Alarm Interface unit must be remotely located. Multiple LTC 8540/00 Alarm Interfaces may be remoted via the LTC 8713 alarm port expander accessory, located at the Main switcher site in LTC 8800 and LTC 8900 systems. Up to two (2) LTC 8540/00 alarm interfaces with a LTC 8713 alarm port expander can be used in a LTC 8600 system. One LTC 8540/00 can be used in LTC 8500 systems. Since the LTC 8100, LTC 8200, and LTC 8300 Series contain an integral alarm interface, the remote alarm interface application does not apply.

A unique time and date synchronizing feature provided in the Time Event Table of the MCS or the GUI Software may be programmed into the Main site switcher. This permits periodic synchronizing of the time and date to all remote switchers in the system based on the Main site's clock.

A conceptual diagram of a satellite switching system is follows:

Conceptual Diagram of Allegiant Satellite Switching System

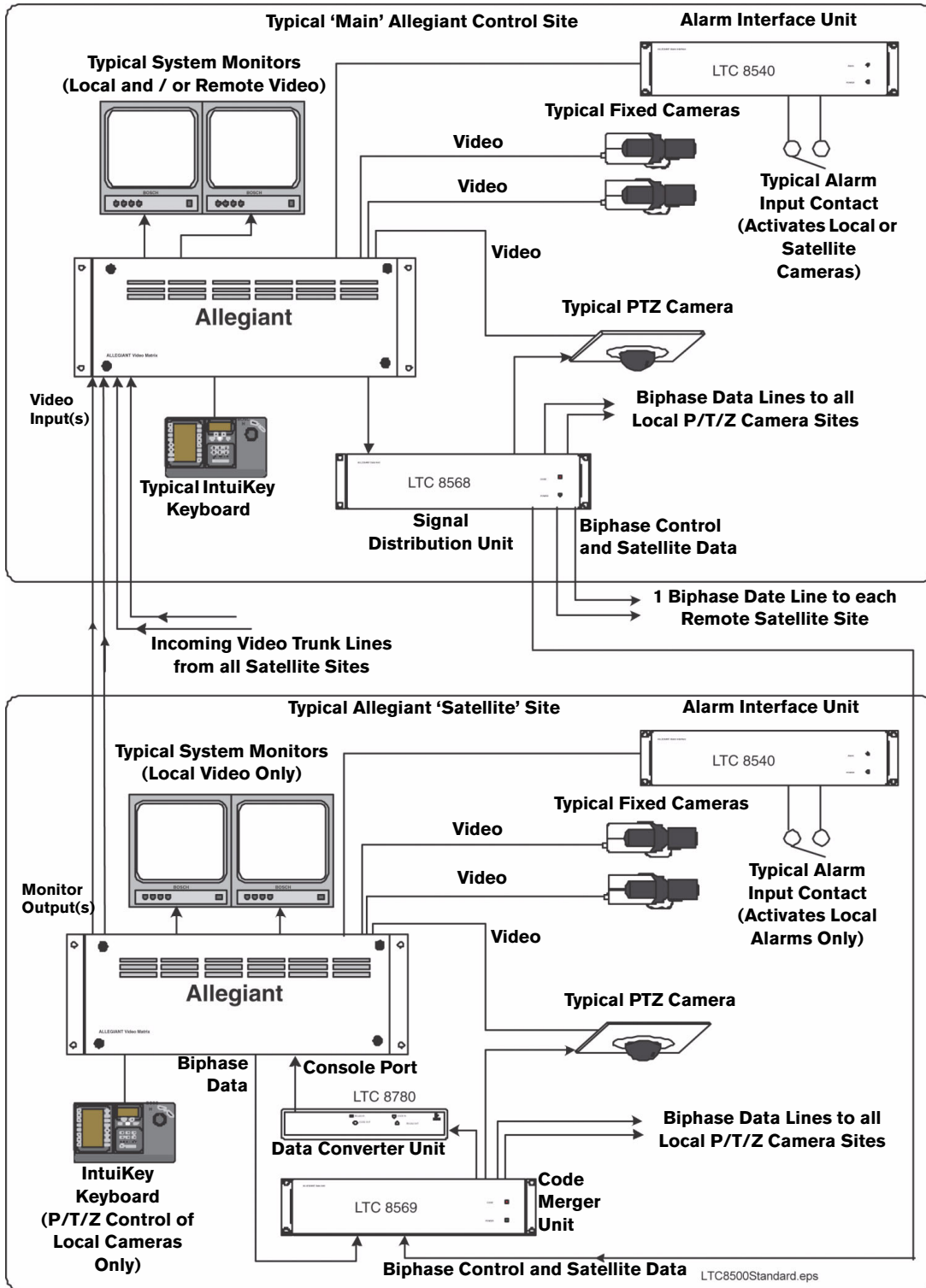
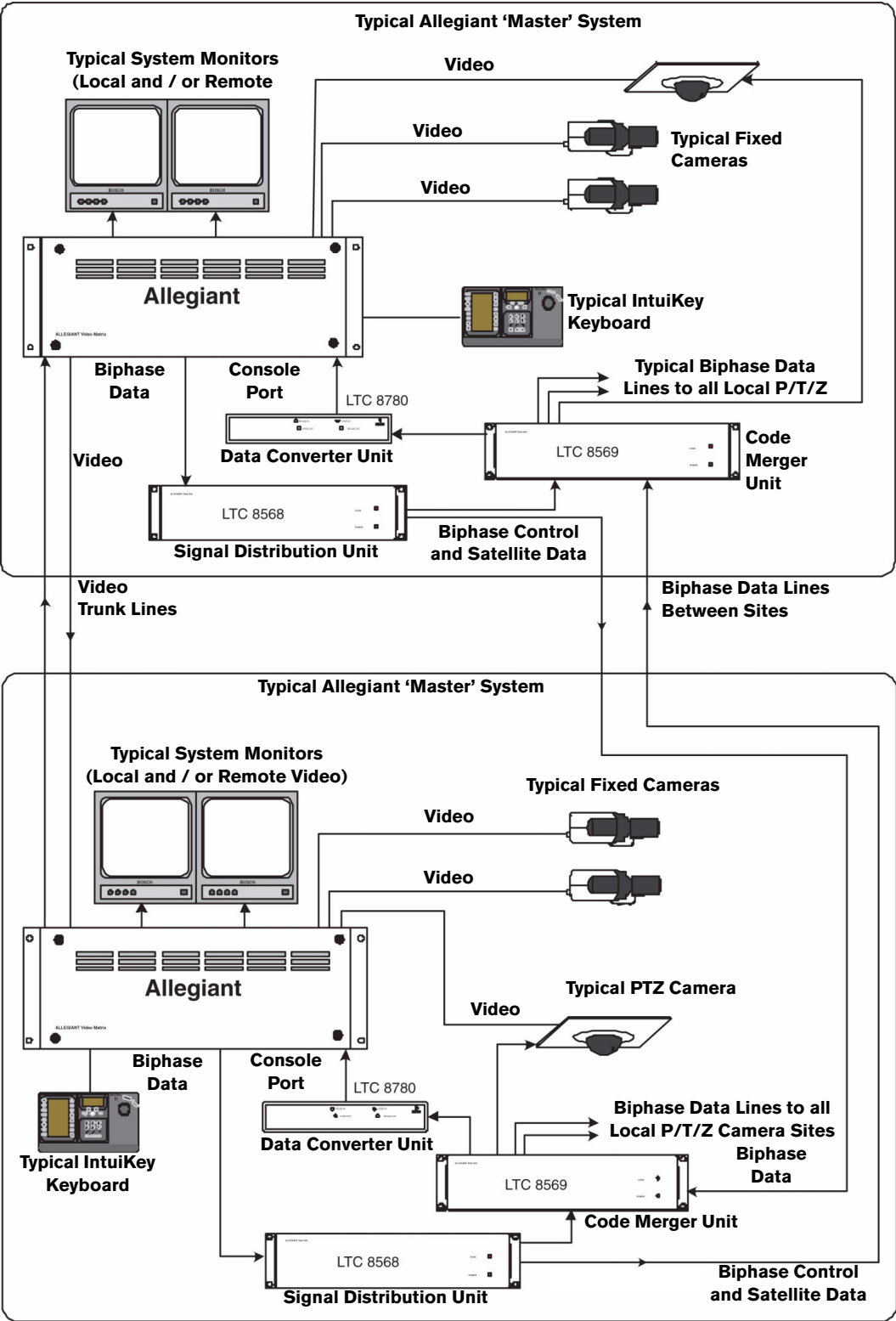

Figure 17: Conceptual Diagram of Allegiant Satellite Switching System

Conceptual Diagram of Dual Master Allegiant Satellite System



LTC8500Dual.eps

Figure 18: Conceptual Diagram of Dual Master Allegiant Satellite System

Conceptual Diagram of Cascaded Allegiant Satellite System

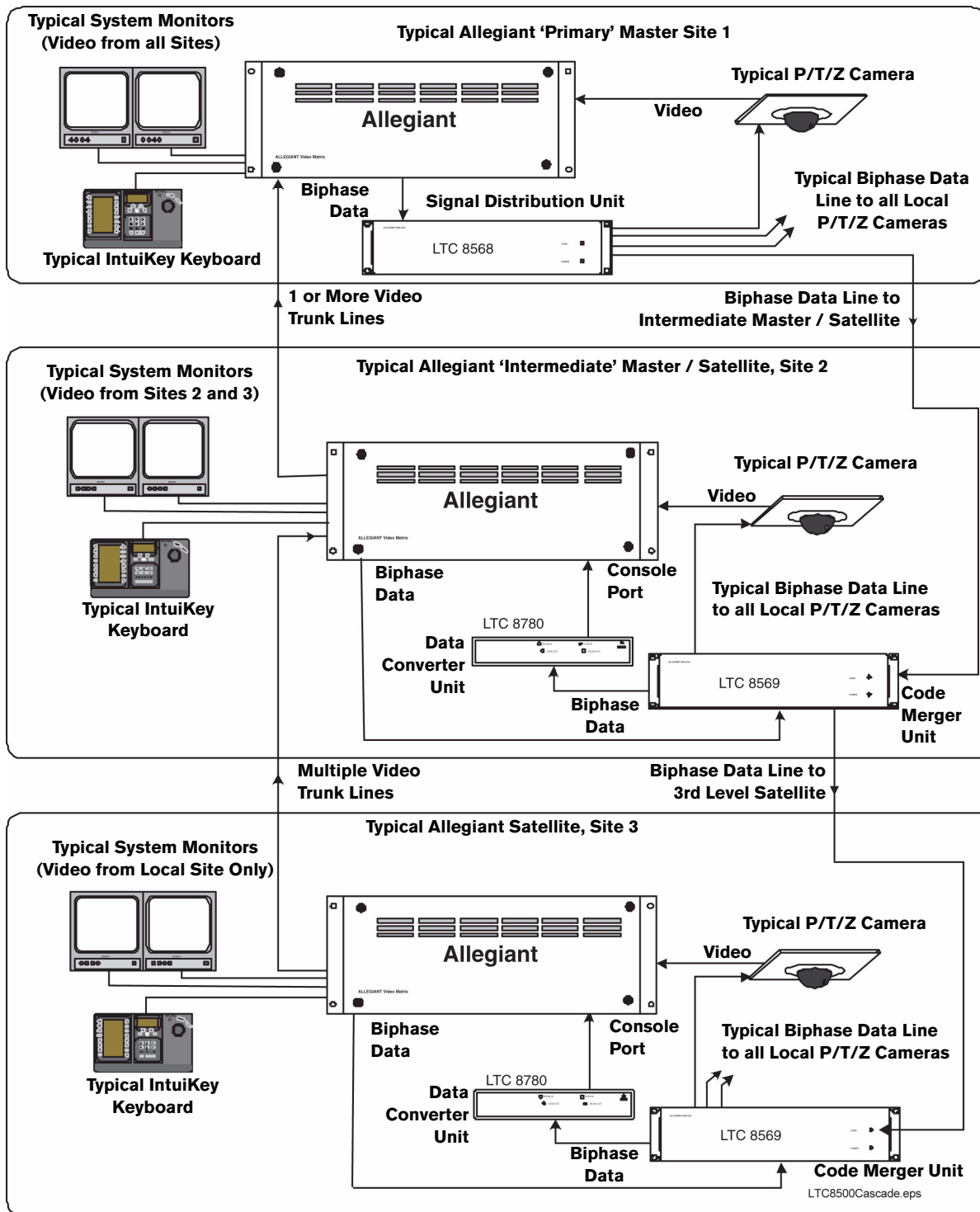

Figure 19: Conceptual Diagram of Cascaded Allegiant Satellite System

Appendix B Installation Checklists

A simplified guide for those who are already familiar with installing and programming Allegiant systems.

MAIN BAY HARDWARE INSTALLATION	
✓	Unpack equipment and verify that items have been received without carrier damage.
✓	Install power supply (do not turn ON) and CPU module.
✓	If applicable, install bay into EIA 19-inch rack (remember to remove rubber bumper foot pads).
✓	Install video input module(s) following proper termination procedures. Install video output module(s).
✓	Connect camera inputs and monitor outputs to appropriate connections on equipment bay(s).
✓	Connect system keyboards, any alarm interface unit(s), and any signal distribution unit to the main bay.
✓	Set CPU DIP switches to activate desired features.
✓	Apply main AC power to equipment.
✓	Verify system is operating properly then begin appropriate programming.

PROGRAMMING VIA SYSTEM KEYBOARD	
✓	Enter system time (User Function 7) and date (User Function 8). Enter Camera ID titles (User Function 9), and if desired, adjust monitor overlay displays (User Function 4, 5, & 6 or 24, 25 & 26).
✓	Enter desired Sequences.
✓	Configure and test alarm response mode.

SATELLITE CONFIGURATION HARDWARE INSTALLATION	
Main Site:	
✓	Install main Allegiant bay and appropriate accessory products accordingly. Verify the biphas control code line is run to each satellite site.
✓	Attach trunk line inputs, local camera inputs, and monitor outputs to the main Allegiant bay. Apply main AC power to equipment.
✓	Program Camera ID Table using the LTC 8059 MCS package.
✓	Switch all unused monitor outputs located at the main site to display a 'local' camera input.
Satellite Site(s):	
✓	Install satellite switcher and appropriate accessory products accordingly.
✓	Connect the biphas code line to the LTC 8780 Data Converter unit and configure according to the desired satellite address and switcher's baud rate.
✓	If necessary, program the satellite switcher for the desired camera titles and any other related requirements.

Appendix C Quick Reference Cable Interconnections

C.1 Main Bay Video

COAX-All video input and output connections to the Allegiant system should be made using a good grade of RG59U, RG6, or RG11U coaxial cable using BNC connectors. The following guidelines should be used to insure selection of the proper cable type:

1. Center conductor of copper, not copper weld or steel. Use stranded wire where there will be cable movement as with pan/tilts, elevators, etc.
2. Copper braided shield at 93% coverage or better.
3. Cable impedance of 75 ohms.
4. Select cable based on target of no more than 15 ohms of center conductor resistance. A typical value for RG59U is 15 ohms per 300 m (1000 ft), therefore maximum cable run should be no more than 300 m (1000 ft). RG11U/RG6 is typically rated for 6 ohms per 300 m (1000 ft) which permits runs up to 760 m (2500 ft).
5. Use video amplifiers to extend cable distances beyond maximum limitations listed above.

C.2 Keyboards

- The keyboard comes supplied with 3 m (10 ft) of 6 conductor phone type cable with RJ-11 connectors. The cable plugs directly into the rear of the system's main bay on one end and into the back of the keyboard on the other end. Both data and power for the keyboard travel over this cable.
- An optional 30 m (100 ft) cable is also available.
- An optional kit which permits the keyboard to be extended beyond 30 m (100 ft) is available and uses customer supplied shielded twisted pair. The kit consists of two "breakout" boxes which convert from the phone type cables to the shielded twisted pair and also provide for local keyboard power. Maximum distance using 24 gauge wire (Belden 9841 or equivalent) is typically 1.5 km (5000 ft).

C.3 Alarm Interface Unit

CONNECTION TO MAIN BAY

The Alarm unit is supplied with a 3 m long (10 ft) multiconductor cable with 9-pin D-type connectors. Power to the Alarm unit is provided by the Allegiant's main bay using the supplied cable. There are provisions to remote the bay which would then require local 12 VAC power and a minimal 3 wire RS-232 communication link.

ALARM INPUTS

The alarm inputs can be dry contact closures or logic levels. Connection to the Alarm unit is made to removable screw type terminal blocks and the use of simple twisted pair wire is acceptable.

C.4 Signal Distribution Unit

CONNECTION TO MAIN BAY

The Distribution unit is supplied with a 3 m long (10 ft) multiconductor cable with 9-pin D-type connectors. Power to the unit is provided by the Allegiant's main bay using the supplied cable. The cable should not be extended so it is recommended that the unit be located close to the main bay.

DISTRIBUTION OUTPUTS

Only shielded twisted pair wire should be used between the Distribution unit and the camera site receiver/drivers. Connection to the Distribution unit is made to removable screw terminal type blocks. Each output is rated to handle up to eight receiver/driver loads as in a daisy chain configuration to a maximum of 1.5 km (5000 ft) using a 18 gauge wire (Belden 8760 or equivalent).

C.5 Receiver/Drivers

CODE INPUT

The code input is supplied by the shielded twisted pair cable from the Signal Distribution unit. This is connected to a removable screw terminal type block which has provisions for "looping" the code cable to another receiver/driver.

OUTPUT CONNECTIONS

All pan/tilt and lens connections will require multiconductor cable. Refer to the appropriate specification sheet for cable gage, number of conductors required, and maximum distances allowable. The lens cables and any pre-position cables should be kept shielded from other signal wires to minimize interference.

23 Main Bay Rear Panel Connector Pin-outs and Cable Pin-out

Console Port RS-232 Pin-outs

Pin #	Designation
1	CHASSIS GND
2	Rx
3	Tx
4	CTS
5	RTS
6	NO CONNECTION
7	DATA GND
8	NO CONNECTION
9	NO CONNECTION

Alarm Port RS-232 Pin-outs

Pin #	Designation
1	RTS
2	Tx
3	CHASSIS GND
4	DATA GND
5	DATA GND
6	Rx
7	CTS
8	12 VAC
9	12 VAC

Keyboard RS-485 Ports

Pin #	Designation
1	12 VAC
2	GND
3	-DATA
4	+DATA
5	GND
6	12 VAC

Printer Port RS-232 Pin-outs

Pin #	Designation
1	CHASSIS GND
2	Rx
3	Tx
4	CTS
5	RTS
6	NO CONNECTION
7	DATA GND
8	NO CONNECTION
9	NO CONNECTION

Code Port Pin-outs

Pin #	Designation
1	+DATA
2	-DATA
3	GND
4	GND
5	GND
6	NO CONNECTION
7	NO CONNECTION
8	12 VAC
9	12 VAC

COMM PORT 1 and COMM PORT 2
(Not Applicable to All Systems)

Pin #	Designation
1	CHASSIS GND
2	+TXD
3	-TXD
4	+RXD
5	-RXD
6	GND
7	GND
8	GND
9	GND

- The LTC 8506/00 cable (used to connect the Allegiant's console port to an external PC) uses the following pin-outs:

9-Pin Male (Console)	Allegiant Designation	9-Pin Female (PC Side)
1	Chassis GND	None
2	Receive	Data 3
3	Transmit	Data 2
4	CTS	1
5	RTS	8
6	No Connection	None
7	Data GND	5
8	No connection	None
9	No connection	None
		(pins 4 & 6 jumpered)
		(pins 1 & 7 jumpered)

- For reference, a cable to connect the Allegiant's printer port to an external serial printer would use the following pin-outs:

9-Pin Male Printer (Printer)	Allegiant Designation	25-Pin Female (Printer Side)
1	Chassis GND	1
2	Receive Data	2
3	Transmit Data	3
4	CTS	4,8
5	RTS	5
6	No Connection	None
7	Data GND	7
8	No connection	None
9	No connection	None
		(pins 6 & 20 jumpered)

Americas

Bosch Security Systems
130 Perinton Parkway
Fairport, New York, 14450 USA
Phone: +1 (585) 223 4060
+1 800 289 0096
security.sales@us.bosch.com
<http://www.boschsecurity.us>

Europe, Middle East, Africa

Bosch Security Systems B.V.
P.O. Box 80002
5600 JB Eindhoven, The Netherlands
Phone: +31 (0) 40 27 83955
Fax: +31 (0) 40 27 86668
emea.securitysystems@bosch.com
<http://www.boschsecurity.com>

Asia-Pacific

Bosch Security Systems Pte Ltd
38C Jalan Pemimpin
Singapore 577180
Phone: +65 6319 3450
Fax: +65 6319 3499
apr.securitysystems@bosch.com
<http://www.boschsecurity.com>

© 2005 Bosch Security Systems GmbH

F01U011796_01 | Updated December 13, 2005 | Data subject to change without notice

BOSCH

Free Manuals Download Website

<http://myh66.com>

<http://usermanuals.us>

<http://www.somanuals.com>

<http://www.4manuals.cc>

<http://www.manual-lib.com>

<http://www.404manual.com>

<http://www.luxmanual.com>

<http://aubethermostatmanual.com>

Golf course search by state

<http://golfingnear.com>

Email search by domain

<http://emailbydomain.com>

Auto manuals search

<http://auto.somanuals.com>

TV manuals search

<http://tv.somanuals.com>