



VOT-320

VOT-320V0xxx



BOSCH

en Installation and Operating Manual

Table of Contents

1	Preface	6
1.1	About this manual	6
1.2	Conventions in this manual	6
1.3	Intended use	6
1.4	EU Directives	7
1.5	Rating plate	7
2	Safety information	8
2.1	Electric shock hazard	8
2.2	Installation and operation	8
2.3	Maintenance and repair	9
3	Product description	10
3.1	Parts included	10
3.2	System requirements	11
3.3	Overview of functions	12
3.4	Controls and displays on the camera module	15
3.5	Connections on the camera module	16
4	Installation	17
4.1	Preparations	17
4.2	Mounting	17
4.3	Connections	19
4.4	Power on/power off	21
4.5	Adjusting the lens (only WFOV lenses)	22
4.6	Final assembly	22
4.7	Setup using Bosch Video Client	22
5	Configuration using a Web browser	24
5.1	Connecting	24
5.2	Configuration menu	26
5.3	Basic Mode: Device Access	28
5.4	Basic Mode: Date/Time	29
5.5	Basic Mode: Network	30
5.6	Basic Mode: Encoder	31
5.7	Basic Mode: Recording	32
5.8	Basic Mode: System Overview	32
5.9	Advanced Mode: Identification	33
5.10	Advanced Mode: Password	34
5.11	Advanced Mode: Date/Time	35
5.12	Advanced Mode: Display Stamping	36
5.13	Advanced Mode: Appearance	37
5.14	Advanced Mode: LIVEPAGE Functions	38
5.15	Advanced Mode: Logging	39
5.16	Advanced Mode: Picture Settings	40

5.17	Advanced Mode: Encoder Profile	40
5.18	Advanced Mode: Encoder Streams	43
5.19	Advanced Mode: Storage Management	45
5.20	Advanced Mode: Recording Profiles	48
5.21	Advanced Mode: Retention Time	50
5.22	Advanced Mode: Recording Scheduler	51
5.23	Advanced Mode: Recording Status	53
5.24	Advanced Mode: Alarm Connections	53
5.25	Advanced Mode: VCA	56
5.26	Advanced Mode: VCA profiles	57
5.27	Advanced Mode: VCA Scheduled	60
5.28	Advanced Mode: VCA Event triggered	62
5.29	Advanced Mode: Alarm E-Mail	63
5.30	Advanced Mode: Alarm Task Editor	65
5.31	Advanced Mode: Alarm Inputs	66
5.32	Advanced Mode: Relay	66
5.33	Advanced Mode: COM1	68
5.34	Advanced Mode: Network	69
5.35	Advanced Mode: Advanced	73
5.36	Advanced Mode: Multicast	75
5.37	Advanced Mode: FTP Posting	76
5.38	Advanced Mode: Encryption	77
5.39	Advanced Mode: Maintenance	77
5.40	Advanced Mode: Licenses	79
5.41	Advanced Mode: System Overview	80
5.42	Function test	81
6	Operation	82
6.1	Operation with Microsoft Internet Explorer	82
6.2	The LIVEPAGE	84
6.3	Saving snapshots	87
6.4	Recording video sequences	87
6.5	Running recording program	87
6.6	The RECORDINGS page	88
6.7	Hardware connections between video servers	90
6.8	Operation using software decoders	92
7	Maintenance and upgrades	93
7.1	Testing the network connection	93
7.2	Camera reset	93
7.3	Fuse replacement	94
7.4	Repairs	94
7.5	Transfer and disposal	94
7.6	Export limitations	94
8	Appendix	95
8.1	Troubleshooting	95
8.2	General malfunctions	95
8.3	Malfunctions with iSCSI connections	97

8.4	LEDs	97
8.5	Processor load	98
8.6	Network connection	98
8.7	Serial interface	98
8.8	Terminal blocks	99
8.9	Communication with terminal program	101
8.10	Copyrights	103
9	Specifications	104
9.1	Camera	104
9.2	Detector	104
9.3	Protocols/standards	105
	Glossary	106
	Index	111

1 Preface

1.1 About this manual

This manual is intended for persons responsible for the installation and operation of the thermal IP camera VOT-320. International, national and any regional electrical engineering regulations must be followed at all times. Relevant knowledge of network technology is required. The manual describes the installation and operation of the camera.

1.2 Conventions in this manual

In this manual, the following symbols and notations are used to draw attention to special situations:

**CAUTION!**

This symbol indicates that failure to follow the safety instructions described may endanger persons and cause damage to the unit or other equipment. It is associated with immediate, direct hazards.

**NOTICE!**

This symbol refers to features and indicates tips and information for easier, more convenient use of the unit.

1.3 Intended use

The thermal IP camera VOT-320 transfers video and control signals over data networks (Ethernet LAN, Internet). There are various memory options for recording the captured images. The camera is intended for use with CCTV systems. Various functions can be triggered automatically by incorporating external alarm sensors. Other applications are not permitted.

In the event of questions concerning the use of the unit which are not answered in this manual, please contact your sales partner or:

Bosch Sicherheitssysteme GmbH

Werner-von-Siemens-Ring 10

85630 Grasbrunn

Germany

www.boschsecurity.com

1.4 EU Directives

The thermal IP camera VOT-320 complies with the requirements of EU Directives 89/336 (Electromagnetic Compatibility) and 73/23, amended by 93/68 (Low Voltage Directive).

1.5 Rating plate

For exact identification, the model name and serial number are inscribed on the back of the housing. Please make a note of this information before installation, if necessary, so as to have it to hand in case of questions or when ordering spare parts.

2 Safety information

2.1 Electric shock hazard

- Never attempt to connect the camera to any power network other than the type for which it is intended.
- Use only SELV power supply units with UL approval.
- Never open the cover of the camera module.
- Never open the housing of the power supply unit.
- If a fault occurs, disconnect the power supply unit from the power supply and from all other units.
- Install the power supply only in a dry, weather-protected location.
- If safe operation of the camera cannot be ensured, remove it from service and secure it to prevent unauthorized operation. In such cases, have the unit checked by Bosch Security Systems.

Safe operation is no longer possible in the following cases:

- if there is visible damage to the unit or power cables,
- if the unit no longer operates correctly,
- if internal components have been exposed to rain or moisture,
- if foreign bodies have penetrated the unit,
- after long storage under adverse conditions, or
- after exposure to extreme stress in transit.

2.2 Installation and operation

- The relevant electrical engineering regulations and guidelines must be complied with at all times during installation.
- Relevant knowledge of network technology is required to install the camera.
- Before installing or operating the camera, make sure you have read and understood the documentation for the other equipment connected to it, such as pan/tilts. The documentation contains important safety instructions and information about permitted uses.
- Perform only the installation and operation steps described in this manual. Any other actions may lead to personal injury, damage to property or damage to the equipment.
- Ensure a secure footing whenever working in elevated positions (e.g. on roofs or poles). Use only safety ladders. If necessary, use a safety harness or railings.
- Use only adequate cables, e.g. marked “Outdoor Cable” or “Water Resistant” for outdoor installation. For the US, cables must comply with NATIONAL ELECTRICAL CODE, NFPA 70.

2.3 Maintenance and repair

- Never open the cover of the camera module inside. The unit does not contain any user-serviceable parts.
- Never open the housing of the power supply unit. The power supply unit does not contain any user-serviceable parts.
- Ensure that all maintenance or repair work is carried out only by qualified personnel (electrical engineers or network technology specialists).

**CAUTION!**

If the camera is mounted to a pan/tilt, ensure that your hands do not get caught or crushed between camera and pan/tilt.

3 Product description

3.1 Parts included

- VOT-320 thermal IP camera
- 1 pre-installed IVA Intelligent Video Analysis
- 5 terminal blocks
- 1 focussing tool (to be used with WFOV lenses)
- 10 screws, 2 washers and 2 lock washers to fasten the housing
- 3 tamper resistant torx screws to lock the latches
- 1 torx wrench
- 4 cable glands
- 3 nuts for cable glands
- 3 plugs for unused cable glands
- 1 shielded RJ45 plug
- 1 Quick Installation Guide
- Product CD with the following content:
 - Quick Installation Guide
 - Manual
 - System Requirements document
 - Further documentation on Bosch Security Systems products
 - Bosch Video Client
 - MPEG ActiveX control
 - DirectX control
 - Sun JVM
 - Adobe Acrobat Reader

**NOTICE!**

Check that the delivery is complete and in perfect condition. Arrange for the unit to be checked by Bosch Security Systems if you find any damage.

3.2 System requirements

General requirements

- Computer with Windows XP or Windows Vista operating system
- Network access (Intranet or Internet)
- Screen resolution at least 1,024 × 768 pixels
- 16- or 32-bit color depth
- Installed Sun JVM



NOTICE!

Also note the information in the **System Requirements** document on the product CD supplied. If necessary, you can install the required programs and controls from the product CD supplied (see *Section 3.1 Parts included, page 10*).

The Web browser must be configured to enable Cookies to be set from the IP address of the unit.

In Windows Vista, deactivate protected mode on the **Security** tab under **Internet Options**.

You can find notes on using Microsoft Internet Explorer in the online Help in Internet Explorer.

Additional configuration requirements

- Microsoft Internet Explorer (version 7.0 or higher)
or
- Installed Bosch Video Client program (version 1.0 or higher)

Additional operational requirements

- Microsoft Internet Explorer (version 7.0 or higher)
or
- Receiver software, for example Bosch Video Client (version 1.0 or higher) or Bosch Video Management System (version 2.3 or higher)
or
- H.264 compatible hardware decoder from Bosch Security Systems (for example VIP XD) as a receiver and connected video monitor
- For playing back recordings: connection to storage medium

3.3 Overview of functions

Thermal IP camera

The thermal IP camera VOT-320 is a complete network video surveillance system inside a weather-proof housing. It provides high sensitivity, uncooled long wave thermal images. Six choices of lenses are available (both narrow and wide field of view) and frame rates of 8.33 or 30 Hz.

VOT-320 is designed to combine the benefits of thermal imaging with the well-proven Bosch IVA features. Thus a unique product was created that offers early detection and display of irregularities over large areas even with poor visibility or absolute darkness. Neither dense smoke nor bad weather conditions as heavy fog or snow affect visibility. With a VOT-320 there is no need for natural or artificial lighting of the area of interest.

The camera incorporates a network video server. Its primary function is to encode video and control data for transmission over an IP network. With its H.264 encoding, it is ideally suited for IP communication and for remote access to digital video recorder and IP systems. The use of existing networks means that integration with CCTV systems or local networks can be achieved quickly and easily. Video images from a single camera can be simultaneously received on several receivers.

Outstanding image quality

The camera uses a Vanadium Oxide (VOx) focal plane array with an image resolution of 320 × 240 pixels that delivers outstanding image quality and sensitivity. The Bosch designed digital video processing system optimally handles the thermal image format without compromise. Temperature differences of 50 mK or less are made visible. Video processing features include multiple automatic, dynamic image optimization algorithms, as well as polarity control (white hot/black hot). Automatic flat-field correction (FFC) grants proper calibration of the detector throughout the operation.

Receiver

Compatible H.264 enabled hardware decoders (for example the VIP XD) can be used as receivers. Computers with decoding software such as Bosch Video Client or computers with the Microsoft Internet Explorer Web browser can also be used as receivers.

Video encoding

The VOT-320 uses the H.264 compression standards. Thanks to efficient encoding, the data rate remains low even with high image quality and can also be adapted to local conditions within wide limits.

Tri-streaming

Tri-streaming allows the data stream to be encoded simultaneously according to three different, individually customized profiles. This creates two full H.264 streams that can serve different purposes and an additional M-JPEG stream.

Multicast

In suitably configured networks, the multicast function enables simultaneous real-time video transmission to multiple receivers. The UDP and IGMP V2 protocols must be implemented on the network for this function.

Encryption

The VOT-320 offers a variety of options for protection against unauthorized reading. Web browser connections can be protected using HTTPS. You can protect the control channels via the SSL encryption protocol. With an additional license, the user data itself can be encrypted.

Remote control

For remote control of external units such as pan/tilts, control data is transmitted via the VOT-320's bidirectional serial interface, or directly via the control outputs. The serial interface can also be used to transmit transparent data.

Tamper detection and video content analysis

The VOT-320 offers a wide range of configuration options for alarm signaling in the event of tampering with the camera. Two algorithms for detecting movement in the video image, MOTION+ and IVA are integrated offering extended video content analysis.

Snapshots

Individual video frames (snapshots) from the VOT-320 can be called up as JPEG images, stored on the computer's hard drive or displayed in a separate browser window.

Recordings

The camera provides local SD card storage for shorter storage times and temporary recordings. Attached to the network, the camera can use iSCSI targets to store long-term recordings. The iSCSI storage target support enables the camera to function as a conventional DVR, while streaming high-performance live video across the network.

Backup

A function for storing the video images displayed on the hard drive of your computer is available on the **LIVEPAGE**. Video sequences can be stored by means of a mouse click.

ONVIF (Open Network Video Interface Forum)

The camera complies to the ONVIF standard which means that it is easier to install and integrate into larger systems. The ONVIF standard is a global standard for the interface of network video products.

Summary

The thermal IP camera VOT-320 provides the following main functions:

- Outstanding image quality with 320 × 240 VOx sensor
- Video and data transmission over IP data networks
- Tri-streaming function for the encoder for simultaneous encoding with three individually definable profiles
- Multicast function for simultaneous image transmission to multiple receivers
- One analog BNC composite video output for set-up procedure (NTSC)
- Video encoding to international standard H.264
- Integrated Ethernet port (10/100 Base-T)
- SD slot for SD cards for local storage
- Transparent, bidirectional data channel via RS-232/RS-422/RS-485 serial interface
- Outputs for direct control of Bosch pan/tilts
- Configuration and remote control of all internal functions via TCP/IP, also secured via HTTPS
- Pre-installed IVA video content analysis algorithm
- Password protection to prevent unauthorized connection or configuration changes
- Extensive, flexible storage options
- Two alarm inputs and two relay outputs
- Built-in video sensor for motion and tamper alarms
- Event-controlled automatic connection
- Convenient maintenance via uploads
- Flexible encryption of control and data channels
- Authentication according to international standard 802.1x
- TEC-less operation without thermo-electric cooler
- Automatic flat-field correction (FFC)

3.4 Controls and displays on the camera module

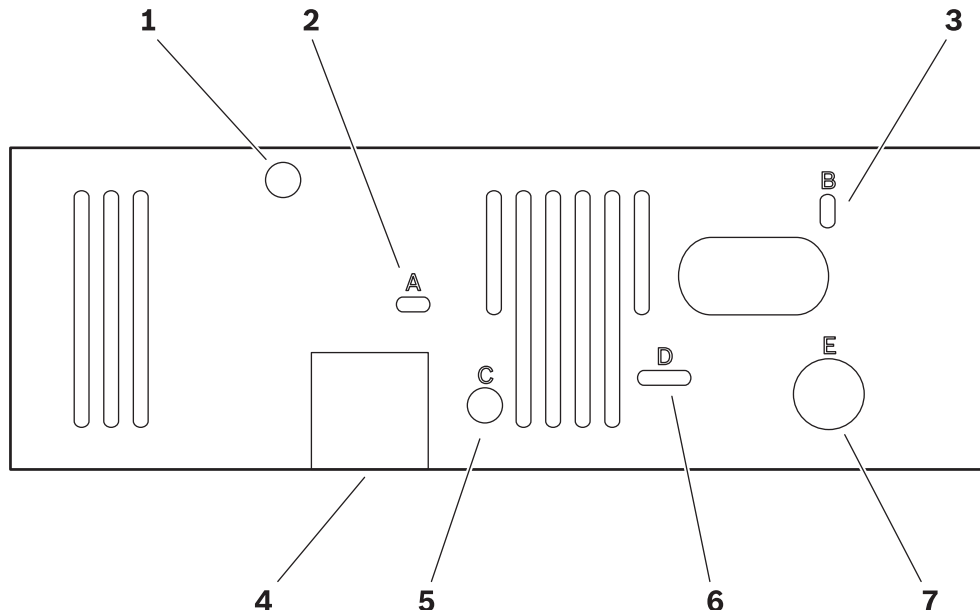

- 1** Tamper switch
detects every attempt to open the housing
- 2** Opening **A**: **CONNECT** LED
lights up green when ready for operation
- 3** Opening **B**: **ACT** and **LINK** LEDs
green LED (link): network connection established,
orange LED (activity): data transmission via network connection
- 4** SD slot
for an SD card
- 5** Opening **C**: factory reset button
to restore factory default settings
- 6** Opening **D**: LED group **D**
information on camera and pan/tilt functions
- 7** Opening **E**: fuse holder **F501**



NOTICE!

For more information about the LEDs, see *Section 8.4 LEDs, page 97*.

3.5 Connections on the camera module

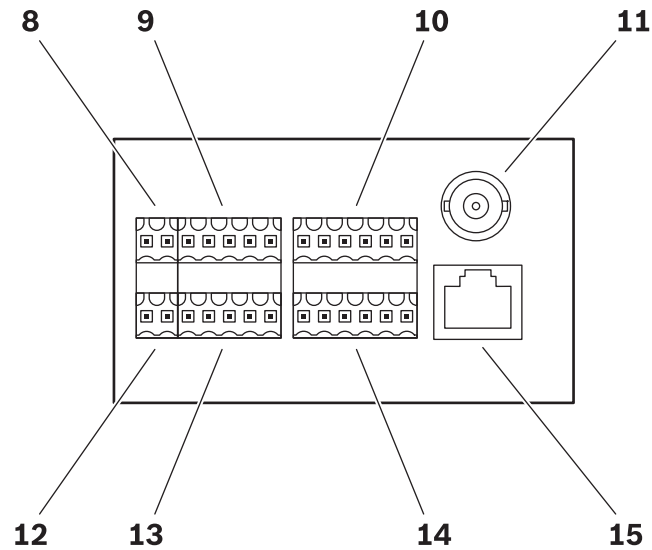

- 8** Upper 2-pin terminal block for power supply
- 9** Upper 5-pin terminal block for pan/tilt connections
- 10** Upper 6-pin terminal block for serial interface connections
- 11** Video output
BNC socket for connecting a service monitor during camera set-up
- 12** Lower 2-pin terminal block for window defroster
- 13** Lower 5-pin terminal block for pan/tilt connections
- 14** Lower 6-pin terminal block for alarm inputs and relay outputs
- 15** RJ45 socket for connecting to an Ethernet LAN (local network), 10/100 MBit Base-T



NOTICE!

For terminal block assignment, see *Section 8.8 Terminal blocks, page 99*.

4 Installation

4.1 Preparations

**CAUTION!**

The camera is intended for indoor and outdoor use.

Select a suitable location for installation that guarantees to meet the environmental conditions. The ambient temperature must be between -50 and +55 °C (-58 and +131 °F). The relative humidity must not exceed 93%.

Please ensure the following installation conditions:

- Do not install the unit close to heat sources. Avoid locations exposed to direct sunlight.
- Allow sufficient space for running cables.
- Ensure that the unit has adequate ventilation.
- When making connections, use only the cables supplied or use appropriate cables immune to electromagnetic interference.
- Ensure to use cables matching the installation location. For example, use cables marked "Outdoor Cable" or "Water Resistant" for outdoor installation. For the US, cables must comply with NATIONAL ELECTRICAL CODE, NFPA 70.
- Position and run all cables so that they are protected from damage, and provide adequate cable strain relief where needed.
- Avoid impacts, blows and severe vibrations that exceed the specification limits (see *Section 9 Specifications, page 104*), as these can irreparably damage the unit.

4.2 Mounting

You can mount the camera to mounts or pan/tilts and place it to walls, below ceilings, on roof tops or poles or any other load-bearing locations.

**CAUTION!**

The camera must be properly and securely mounted to a supporting structure capable of sustaining the unit weight. Use care when selecting mounts or pan/tilts (not supplied) for installation; the mounting surface and unit's weight should be carefully considered.

**CAUTION!**

If the camera is mounted to a pan/tilt, ensure that your hands do not get caught or crushed between camera and pan/tilt.

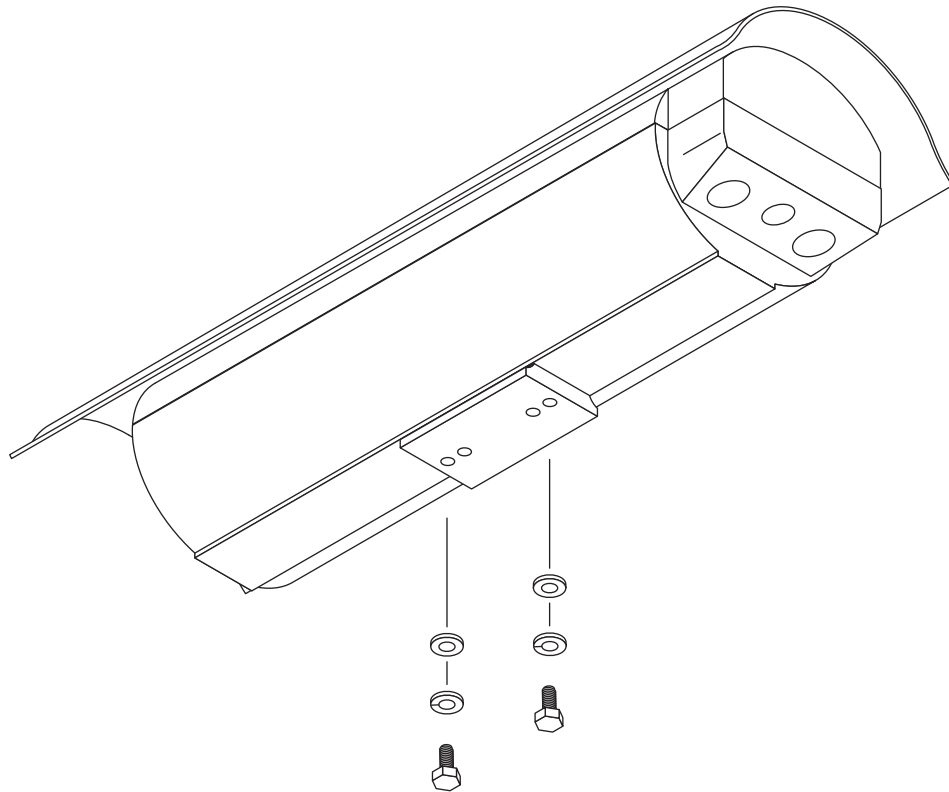

1. Use two appropriate screws, washers and spring washers to mount the camera to a mount or a pan/tilt. The spring washers must be used for the screws to thread properly.
2. Open the cover by unlatching the three latches on the side of the housing.
3. Choose the appropriate cable glands. The following cable glands are provided:
 - 1 × NPT 3/8" for cable diameters from 4 to 8 mm
 - 1 × NPT 3/8" for cable diameters from 2 to 6 mm
 - 2 × NPT 1/2" for cable diameters from 6 to 12 mm
 The identical cable glands are for the outer two openings in the housing. For the middle opening, choose the NPT 3/8" cable gland with the correct diameter for your cabling to prevent water from entering.
4. Fasten the required cable glands. Tighten the glands to a torque of at least 1.6 Nm.
5. Run the required cables through the cable glands and close the glands.



CAUTION!

Always securely tighten all cable glands to ensure a liquid-tight seal. Failure to do so could allow water to enter the housing and damage the camera module and electronic parts. If a sealant is used, be sure it is a neutral cure type. Sealants that release acetic acid may harm camera electronics. Use of drip loops is recommended on the wiring outside of the rear end cap.

4.3 Connections

Network

You can connect the VOT-320 to a 10/100 Base-T network using a standard UTP category 5 cable with RJ45 plugs.

Pin	EIA/TIA-568-A	EIA/TIA-568-B
1	white/green	white/orange
2	green	orange
3	white/orange	white/green
4	blue	blue
5	white/blue	white/blue
6	orange	green
7	white/brown	white/brown
8	brown	brown

1. First crimp the wires according to the EIA/TIA standard you are using.
2. Connect the VOT-320 to the network via the RJ45 socket on the back of the camera module.

Data interface

The bidirectional data interface is used to control units connected to the VOT-320, such as pan/tilts that are not connected directly to the P/T connections (see *Section Pan/tilt connection, page 20*). The connection supports the RS-232, RS-422 and RS-485 transmission standards.

The VOT-320 offers the serial interface via the upper 6-pin terminal block (see *Section 8.8 Terminal blocks, page 99*).

The range of controllable equipment is expanding constantly. The manufacturers of the relevant equipment provide specific information on installation and control.



CAUTION!

Please take note of the appropriate documentation when installing and operating the unit to be controlled.

The documentation contains important safety instructions and information about permitted uses.



NOTICE!

A video connection is necessary to transmit transparent data.

Pan/tilt connection

The pan/tilt connections are used to control a suitable Bosch pan/tilt. Other pan/tilts may be controlled via the serial interface (see *Section Data interface, page 19*). The connections are located on the two 5-pin terminal blocks (see *Section 8.8 Terminal blocks, page 99*).

**NOTICE!**

The release letter for the current firmware version includes a list of compatible Bosch pan/tilts.

**CAUTION!**

Please take note of the appropriate documentation when installing and operating the unit to be controlled. The documentation contains important safety instructions and information about permitted uses.

Alarm inputs

The VOT-320 has two alarm inputs on the lower 6-pin terminal block (see *Section 8.8 Terminal blocks, page 99*). The alarm inputs are used to connect to external alarm devices such as door contacts or sensors. With the appropriate configuration, an alarm sensor can automatically connect the VOT-320 to a remote location, for example.

A zero potential closing contact or switch can be used as the actuator.

**NOTICE!**

If possible, use a bounce-free contact system as the actuator.

- ▶ Connect the lines to the appropriate terminals on the lower 6-pin terminal block (**IN1** and **IN2**) and check that the connection is secure.

Relay outputs

The VOT-320 has two relay outputs for switching external units such as lamps or alarm sirens. You can operate these relay outputs manually while there is an active connection to the VOT-320. The outputs can also be configured to automatically activate sirens or other alarm units in response to an alarm signal. The relay outputs are also located on the lower 6-pin terminal block (see *Section 8.8 Terminal blocks, page 99*).

**CAUTION!**

A maximum load of 30 V_{p-p} (SELV) and 200 mA may be applied to the relay contacts.

- ▶ Connect the lines to the appropriate terminals on the lower 6-pin terminal block (**R1** and **R2**) and check that the connection is secure.

SD slot

You can insert an SD card into the slot on the side of the camera module to enable recordings to be saved locally. SD cards are the ideal solution for shorter storage times and temporary recordings, for example alarm recordings or local buffering in the event of network interruptions.

**NOTICE!**

The release letter for the current firmware version includes a list of compatible SD cards.

Playing back recordings is also possible using a different VOT-320 camera.

**CAUTION!**

If the card is formatted, all existing data is deleted from the card.

You should therefore check whether the SD card contains any data that needs to be backed up before it is inserted.

1. Carefully slide the SD card into the slot as far as it will go, until it locks into place.
2. To remove the SD card, push carefully in the direction of insertion until the mechanical catch releases and then remove the card.

4.4

Power on/power off

Power supply

The VOT-320 does not have a power switch. Power is supplied via a separate unit. Connect the VOT-320 to the power supply unit and plug this into the mains. The camera is now ready for use. The VOT-320 does not come supplied with a power supply unit.

**CAUTION!**

Use only SELV power supply units with UL approval.

Where necessary, use suitable equipment to ensure that the power supply is free from interference such as voltage surges, spikes or voltage drops.

Do not connect the VOT-320 to the power supply until all other connections have been made.

1. Plug the terminal block with the PSU cable connected to it into the upper 2-pin socket on the back of the camera module.
2. Connect the power supply unit to the mains. The VOT-320 is ready for use as soon as the **CONNECT** LED changes from a red light, indicating the start-up procedure, to a green light.

Provided the network connection has been correctly made, the green **LINK** LED also lights up. The lit orange **ACTIVITY** LED signals that data packets are being transmitted via the network.

4.5 Adjusting the lens (only WFOV lenses)

Cameras with 9 mm, 13 mm, and 19 mm cover a wide field of view (WFOV). For these lenses you may need to adjust the camera focus. You connect a service monitor in order to set-up the camera and adjust the lens. Any monitors that support a standard NTSC signal are suitable.

1. Connect the monitor to the BNC socket on the back of the camera module using a video cable (75 Ohm, BNC plug).
2. Check the image on the monitor.
3. If the camera focus needs to be adjusted, loosen the four fixing screws of the camera module.
4. Lift the camera module and slide it backwards in order to reach the lens.
5. Attach the focussing tool to the lens and turn it to set the focus.
6. Remove the focussing tool.
7. Lift the camera module and slide it back to the original position.
8. Refasten the four screws.
9. Disconnect the monitor after set-up.

All other lenses are preset and do not need to be adjusted.

4.6 Final assembly

1. Close unused holes with suitable plugs.
2. Close the cover and secure the latches using the tamper resistant screws and the provided torx wrench.
3. Loosen the two sunshield screws (M4 × 10) on the top of the housing.
4. Slide the sunshield to the desired position. It has a range of 50 mm (2 in).
5. Tighten the screws to lock the sunshade into position.

4.7 Setup using Bosch Video Client

The **Bosch Video Client** program can be found on the product CD supplied. This program allows you to implement and set up the camera in the network quickly and conveniently.



NOTICE!

Using Bosch Video Client to set all parameters in the VOT-320 is an alternative to configuration by means of a Web browser, as described in chapter 5 of this manual.

Installing the program

1. Insert the product disc into the optical drive of the PC;
 - The installation program should start automatically.
2. If installation does not start automatically, locate the **BVC_installer.exe** file on the disk and double-click it.
3. Follow the instructions on the screen to complete the installation.

Configuring the camera

You can start Bosch Video Client immediately after installation.



1. Double-click the  icon on the desktop to start the program. Alternatively, start the application via the Start button and the Programs menu (path: Start/Programs/Bosch Video Client/Bosch Video Client).
2. When the program is started for the first time, a wizard opens to help you detect and configure devices on the network.

3. If the wizard does not start automatically, click  to open the Configuration Manager application. Then, click **Configuration Wizard...** on the **Tools** menu.



4. Follow the instructions given in the **Configuration Wizard** window.

Additional parameters

You can check and set additional parameters with the assistance of the Configuration Manager application in Bosch Video Client. You can find detailed information on this in the documentation for these applications.

5 Configuration using a Web browser

5.1 Connecting

The integrated HTTP server in the VOT-320 provides you with the option to configure the camera over the network with a Web browser. This option is an alternative to configuration using the Configuration Manager application in Bosch Video Client and is considerably richer in function and more convenient than configuration using the terminal program.

System requirements

- Computer with Windows XP or Windows Vista operating system
- Network access (Intranet or Internet)
- Microsoft Internet Explorer (version 7.0 or higher)
- Screen resolution at least 1,024 × 768 pixels
- 16- or 32-bit color depth
- Installed Sun JVM



NOTICE!

Also note the information in the **System Requirements** document on the product CD supplied. If necessary, you can install the required programs and controls from the product CD supplied (see *Section 3.1 Parts included, page 10*).

The Web browser must be configured to enable Cookies to be set from the IP address of the camera.

In Windows Vista, deactivate protected mode on the **Security** tab under **Internet Options**.

You can find notes on using Microsoft Internet Explorer in the online Help in Internet Explorer.

Installing MPEG ActiveX

Suitable MPEG ActiveX software must be installed on the computer to allow the live video images to be played back. If necessary, you can install the program from the product CD supplied.

1. Insert the product CD into the computer's CD-ROM drive. If the CD does not start automatically, open the root directory of the CD in Windows Explorer and double-click **MPEGAx.exe**.
2. Follow the on-screen instructions.

Establishing the connection

Before you can operate the VOT-320 within your network, it must have a valid IP address for your network and a compatible subnet mask.

The following default address is preset at the factory: **192.168.0.1**

1. Start the Web browser.
2. Enter the IP address of the VOT-320 as the URL.
3. During initial installation, confirm the security questions that appear. The connection is established and after a short time you will see the **LIVEPAGE** with the video image.



Maximum number of connections

If you do not connect, the camera may have reached its maximum number of connections. Depending on the unit and network configuration, each VOT-320 can have up to 25 Web browser connections or up to 50 connections via Bosch Video Client or Bosch Video Management System.

Protected camera

If the VOT-320 is password protected against unauthorized access, the Web browser displays a corresponding message and prompts you to enter the password when you attempt to access protected areas.



NOTICE!

The VOT-320 offers the option to limit the extent of access using various authorization levels (see *Section 5.10 Advanced Mode: Password, page 34*).

1. Enter the user name and associated password in the corresponding text fields.
2. Click **OK**. If the password is entered correctly, the Web browser displays the page that was called up.

Protected network

If a RADIUS server is employed in the network for managing access rights (802.1x authentication), the VOT-320 must be configured accordingly, otherwise no communication is possible.

To configure the camera, you must connect the VOT-320 directly to a computer using a network cable. This is because communication via the network is not enabled until the **Identity** and **Password** parameters have been set and successfully authenticated (see *Section Authentication, page 74*).

5.2 Configuration menu

The **SETTINGS** page provides access to the configuration menu, which contains all the camera's parameters arranged in groups. You can view the current settings by opening one of the configuration screens. You can change the settings by entering new values or by selecting a predefined value from a list field.

There are two options for configuring the camera or checking the current settings:

- Basic Mode
- Advanced Mode

In Basic Mode the most important parameters are arranged in seven groups. This allows you to change the basic settings with just a few entries and then put the device into operation. Advanced Mode is recommended for expert users or system support personnel. You can access all device parameters in this mode. Settings that affect the fundamental functionality of the device (such as firmware updates) can only be altered in Advanced Mode.

All parameter groups are described in this chapter in the order in which they are listed in the configuration menu, from the top of the screen to the bottom.



CAUTION!

The settings in the Advanced Mode should only be processed or modified by expert users or system support personnel.

All settings are backed up in the VOT-320 memory so they are not lost even if the power fails. The exception is the time settings, which are lost after 72 hours without power if no central time server is selected (see *Section 5.4 Basic Mode: Date/Time, page 29*).

Starting configuration

- ▶ Click the **SETTINGS** link in the upper section of the window. The Web browser opens a new page with the configuration menu.



Navigation

1. Click one of the menu items in the left window margin. The corresponding submenu is displayed.
2. Click one of the entries in the submenu. The Web browser opens the corresponding page.

Making changes

Each configuration screen shows the current settings. You can change the settings by entering new values or by selecting a predefined value from a list field.

- ▶ After each change, click **Set** to save the change.



CAUTION!

Save each change with the associated **Set** button.

Clicking the **Set** button saves the settings only in the current field. Changes in any other fields are ignored.

5.3 Basic Mode: Device Access

Device Access

Camera name	<input style="width: 90%;" type="text" value="Camera 1"/>
Password 'service'	<input style="width: 90%;" type="password"/>
Confirm password	<input style="width: 90%;" type="password"/>
Password 'user'	<input style="width: 90%;" type="password"/>
Confirm password	<input style="width: 90%;" type="password"/>
Password 'live'	<input style="width: 90%;" type="password"/>
Confirm password	<input style="width: 90%;" type="password"/>

Camera name

The camera name makes it easier to identify the remote camera location, in the event of an alarm for example. It will be displayed in the video screen if configured to do so (see *Section Camera name stamping, page 36*). The camera name makes the task of administering cameras in larger video monitoring systems easier, for example using the Bosch Video Client or Bosch Video Management System programs.

Enter a unique, unambiguous name for the camera in this field.



CAUTION!

Do not use any special characters, for example **&**, in the name. Special characters are not supported by the system's internal management.

Password

A VOT-320 is generally protected by a password to prevent unauthorized access to the camera. You can use different authorization levels to limit access.

The VOT-320 operates with three authorization levels: **service**, **user** and **live**.

The highest authorization level is **service**. After entering the correct password, you can access all the functions of the VOT-320 and change all configuration settings.

With the **user** authorization level, you can operate the camera, play back recordings and also control cameras, for example, but you cannot change the configuration.

The lowest authorization level is **live**. It can only be used to view the live video image and switch between the different live image displays.

You can define and change a password for each authorization level if you are logged in as **service** or if the camera is not password protected.

Enter the password for the appropriate authorization level here. The maximum password text length is 19 characters.



CAUTION!

Do not use any special characters, for example **&**, in the password. Special characters are not supported by the system's internal management.

**NOTICE!**

Proper password protection is only guaranteed when all higher authorization levels are also protected with a password. If a **live** password is assigned, for example, a **service** and a **user** password must also be set. When assigning passwords, you should therefore always start from the highest authorization level, **service**, and use different passwords.

Confirm password

In each case, enter the new password a second time to eliminate typing mistakes.

5.4**Basic Mode: Date/Time**

Date/Time	
Device date	Friday, 19.11.2010
Device time	18:31:09
Device time zone	(UTC +1:00) Western & Central Europe
Time server IP address	<input type="text"/>
Time server type	SNTP server

Buttons: Sync to PC, Cancel, Set

Device date / Device time / Device time zone

If there are multiple devices operating in your system or network, it is important to synchronize their internal clocks. For example, it is only possible to identify and correctly evaluate simultaneous recordings when all units are operating on the same time. If necessary, you can synchronize the camera with your computer's system settings.

- ▶ Click the **Sync to PC** button to copy your computer's system time to the VOT-320.

Time server IP address

The VOT-320 can receive the time signal from a time server using various time server protocols, and then use it to set the internal clock. The camera polls the time signal automatically once every minute.

- ▶ Enter the IP address of a time server here.

Time server type

Select the protocol that is supported by the selected time server. Preferably, you should select **SNTP server** as the protocol. This supports a high level of accuracy and is required for special applications and subsequent function extensions.

Select **Time server** for a time server that works with the protocol RFC 868.

5.5 Basic Mode: Network

Network

DHCP	<input type="text" value="Off"/>
IP address	<input type="text" value="192.168.0.246"/>
Subnet mask	<input type="text" value="255.255.255.0"/>
Gateway address	<input type="text" value="192.168.0.13"/>

The settings on this page are used to integrate the VOT-320 into an existing network. Some changes only take effect after the camera is rebooted. In this case, the **Set** button changes to **Set and Reboot**.

1. Make the desired changes.
2. Click the **Set and Reboot** button. The VOT-320 is rebooted and the changed settings are activated.



CAUTION!

If you change the IP address, subnet mask or gateway address, the VOT-320 is only available under the new addresses after the reboot.

DHCP

If a DHCP server is employed in the network for the dynamic assignment of IP addresses, you can activate acceptance of IP addresses automatically assigned to the VOT-320.

Certain applications (Bosch Video Client, Bosch Video Management System) use the IP address for the unique assignment of the camera. If you use these applications, the DHCP server must support the fixed assignment between IP address and MAC address, and must be appropriately set up so that, once an IP address is assigned, it is retained each time the system is rebooted.

IP address

Enter the desired IP address for the VOT-320 in this field. The IP address must be valid for the network.

Subnet mask

Enter the appropriate subnet mask for the selected IP address here.

Gateway address

If you want the camera to establish a connection to a remote location in a different subnet, enter the IP address of the gateway here. Otherwise leave the box blank (**0.0.0.0**).

5.6 Basic Mode: Encoder

Encoder

Non-recording profile High quality 1 ▾

Property H.264 MP SD

High quality 1

Profile #	1
Encoding interval	1 (30.00 ips)
Video resolution	QVGA
Target bit rate	800 kbps
Maximum bit rate	1600 kbps

Cancel
Set

Non-recording profile

You can select a profile for encoding the video signal.

You can use this to adapt the video data transmission to the operating environment (for example network structure, bandwidth, data load).

Pre-programmed profiles are available, each giving priority to different perspectives. When selecting a profile, details are displayed in the list field. Below is a brief description of the factory default settings for the encoder profiles.



NOTICE!

The names and the technical details for the encoder profiles depend on the configuration of the device.

- **High quality 1**
For high bandwidth connections with IBBP GOP structure
- **High quality 2**
For high bandwidth connections with IP GOP structure
- **Low bandwidth**
For low bandwidth connections with IP GOP structure
- **DSL**
For DSL connections with 500 kbps
- **ISDN (2B)**
For ISDN connections via two B-channels
- **ISDN (1B)**
For ISDN connections via one B-channel
- **MODEM**
For analog modem connections with 20 kbps
- **GSM**
For GSM connections at 9,600 baud

5.7 Basic Mode: Recording

Recording

Storage medium

You can record the images from the camera on the local SD card. SD cards are the ideal solution for shorter storage times. Here you can start or stop the recording.

5.8 Basic Mode: System Overview

System Overview	
Hardware version	F0003242
Firmware version	02500452
Device type	VOT-320V019H
IP address	192.168.0.246
Audio option	No
Storage medium attached	Yes
Initiator name	iqn.2005-12.com.bosch:unit00075f76a975
MAC address	00-07-5F-76-A9-75
Major version number	4.52
Build number	02
Stream 1	High quality 1
Stream 2	High quality 2
Temperature	96°F / 35.5°C (max 113°F / 45°C)
Sensor temperature	83°F / 28.6°C
Serial number	044540600630010055
Sensor serial number	6423

The data on this page are for information purposes only and cannot be changed. Keep a record of these numbers in case technical assistance is required.



NOTICE!

You can select all required text on this page with the mouse and copy it to the clipboard with the [Ctrl]+[C] key combination, for example if you want to send it via e-mail.

5.9 Advanced Mode: Identification

Identification

Camera ID	<input type="text"/>	
Camera name	<input type="text" value="Camera 1"/>	
	<input type="text"/>	
Initiator extension	<input type="text"/>	

Camera ID

Each VOT-320 should be assigned a unique identifier that you can enter here as an additional means of identification.

Camera name

The camera name makes it easier to identify the remote camera location, in the event of an alarm for example. It will be displayed in the video screen if configured to do so (see *Section Camera name stamping, page 36*). The camera name makes the task of administering cameras in larger video monitoring systems easier, for example using the Bosch Video Client or Bosch Video Management System programs.

Enter a unique, unambiguous name for the camera in this field. You can use both lines for this.



CAUTION!

Do not use any special characters, for example **&**, in the name.

Special characters are not supported by the system's internal management.

You can use the second line for entering additional characters; these can be selected from a table.

1. Click the icon next to the second line. A new window with the character map is opened.
2. Click the required character. The character is inserted into the **Result** field.
3. In the character map, click the **<<** and **>>** icons to move between the different pages of the table, or select a page from the list field.
4. Click the **<** icon to the right of the **Result** field to delete the last character, or click the **X** icon to delete all characters.
5. Now click the **OK** button to apply the selected characters to the second line of the **Camera 1** parameters. The window will close.

Initiator extension

You can attach your own text to the initiator name of the VOT-320 to make the camera easier to identify in large iSCSI systems. This text is added to the initiator name, separated from it by a full stop. You can see the initiator name in the system overview (see *Section 5.8 Basic Mode: System Overview, page 32*).

5.10 Advanced Mode: Password

The screenshot shows a web interface for configuring passwords. The title is 'Password'. There are three rows of input fields. The first row is for 'service', the second for 'user', and the third for 'live'. Each row has a 'Password' field and a 'Confirm password' field. A 'Set' button is at the bottom right.

A VOT-320 is generally protected by a password to prevent unauthorized access to the camera. You can use different authorization levels to limit access.



NOTICE!

Proper password protection is only guaranteed when all higher authorization levels are also protected with a password. If a **live** password is assigned, for example, a **service** and a **user** password must also be set. When assigning passwords, you should therefore always start from the highest authorization level, **service**, and use different passwords.

Password

The VOT-320 operates with three authorization levels: **service**, **user** and **live**.

The highest authorization level is **service**. After entering the correct password, you can access all the functions of the VOT-320 and change all configuration settings.

With the **user** authorization level, you can operate the camera, play back recordings and also control cameras, for example, but you cannot change the configuration.

The lowest authorization level is **live**. It can only be used to view the live video image and switch between the different live image displays.

You can define and change a password for each authorization level if you are logged in as **service** or if the camera is not password protected.

Enter the password for the appropriate authorization level here. The maximum password text length is 19 characters.



CAUTION!

Do not use any special characters, for example **&**, in the password.

Special characters are not supported by the system's internal management.

Confirm password

In each case, enter the new password a second time to eliminate typing mistakes.

5.11 Advanced Mode: Date/Time

Date/Time

Date format DD.MM.YYYY

Device date Friday, 19, 11, 2010

Device time 18 : 45 : 36 Sync to PC

Device time zone (UTC +1:00) Western & Central Europe

Daylight saving time Details

Time server IP address

Time server type SNTP server Set

Date format

Select your required date format.

Device date / Device time

If there are multiple devices operating in your system or network, it is important to synchronize their internal clocks. For example, it is only possible to identify and correctly evaluate simultaneous recordings when all units are operating on the same time.

1. Enter the current date. Since the camera time is controlled by the internal clock, there is no need to enter the day of the week – it is added automatically.
2. Enter the current time or click the **Sync to PC** button to copy your computer's system time to the VOT-320.

Device time zone

Select the time zone in which your system is located.

Daylight saving time

The internal clock can switch automatically between normal and daylight saving time (DST). The camera already contains the data for DST switch-overs up to the year 2018. You can use these data or create alternative time saving data if required.



NOTICE!

If you do not create a table, there will be no automatic switching. When changing and clearing individual entries, remember that two entries are usually related to each other and dependent on one another (switching to summer time and back to normal time).

1. First check whether the correct time zone is selected. If it is not correct, select the appropriate time zone for the system, and click the **Set** button.
2. Click the **Details** button. A new window will open and you will see the empty table.
3. Select the region or the city that is closest to the system's location from the list field below the table.
4. Click the **Generate** button to generate data and enter it into the table.
5. Make changes by clicking an entry in the table. The entry is selected.
6. Clicking the **Delete** button will remove the entry from the table.
7. Select other values from the list fields below the table to change the entry. Changes are made immediately.

8. If there are empty lines at the bottom of the table, for example after deletions, you can add new data by marking the row and selecting required values from the list fields.
9. Now click the **OK** button to apply and activate the table.

Time server IP address

The VOT-320 can receive the time signal from a time server using various time server protocols, and then use it to set the internal clock. The camera polls the time signal automatically once every minute.

Enter the IP address of a time server here.

Time server type

Select the protocol that is supported by the selected time server. Preferably, you should select **SNTP server** as the protocol. This supports a high level of accuracy and is required for special applications and subsequent function extensions.

Select **Time server** for a time server that works with the protocol RFC 868.

5.12

Advanced Mode: Display Stamping

Various overlays or "stamps" in the video image provide important supplementary information. These overlays can be enabled individually and are arranged on the image in a clear manner.

Camera name stamping

This field sets the position of the camera name overlay. It can be displayed at the **Top**, at the **Bottom**, or at a position of your choice that you can then specify using the **Custom** option. Or it can be set to **Off** for no overlay information.

1. Select the desired option from the list.
2. If you select the **Custom** option, additional fields are displayed where you can specify the exact position (**Position (XY)**).
3. In the **Position (XY)** fields, enter the values for the desired position.

Time stamping

This field sets the position of the time overlay. It can be displayed at the **Top**, at the **Bottom**, or at a position of your choice that you can then specify using the **Custom** option. Or it can be set to **Off** for no overlay information.

1. Select the desired option from the list.
2. If you select the **Custom** option, additional fields are displayed where you can specify the exact position (**Position (XY)**).
3. In the **Position (XY)** fields, enter the values for the desired position.

Display milliseconds

You can only select this option if the **Time stamping** function is activated. If necessary, you can also display milliseconds. This information can be useful for recorded video images; however, it does increase the processor's computing time. Select **Off** if you do not need to display milliseconds.

Alarm mode stamping

Select **On** to display a text message overlay in the image in the event of an alarm. It can be displayed at a position of your choice that you can then specify using the **Custom** option. Or it can be set to **Off** for no overlay information.

1. Select the desired option from the list.
2. If you select the **Custom** option, additional fields are displayed where you can specify the exact position (**Position (XY)**).
3. In the **Position (XY)** fields, enter the values for the desired position.

Alarm message

Enter the message to be displayed in the image in the event of an alarm. The maximum text length is 31 characters.

Video watermarking

Choose **On** if you wish the transmitted video images to be "watermarked". After activation, all images are marked with an icon. The icon indicates if the sequence (live or saved) has been manipulated (see *Section Display stamping, page 84*).

5.13 Advanced Mode: Appearance

On this page you can adapt the appearance of the web interface and change the website language to meet your requirements. If necessary, you can replace the manufacturer's logo (top right) and the product name (top left) in the top part of the window with individual graphics.

**NOTICE!**

You can use either GIF or JPEG images. The file paths must correspond to the access mode (for example **C:\Images\Logo.gif** for access to local files, or **http://www.mycompany.com/images/logo.gif** for access via the Internet/Intranet). When accessing via the Internet/Intranet, ensure that a connection is always available to display the image. The image file is not stored in the VOT-320.

Website language

Select the language for the user interface here.

Company logo

Enter the path to a suitable graphic if you want to replace the manufacturer's logo. The image file can be stored on a local computer, in the local network or at an Internet address.

Device logo

Enter the path to a suitable graphic if you want to replace the product name. The image file can be stored on a local computer, in the local network or at an Internet address.

**NOTICE!**

If you want to use the original graphics again, simply delete the entries in the **Company logo** and **Device logo** fields.

JPEG interval

You can specify the interval at which the individual images should be generated for the M-JPEG image on the **LIVEPAGE**.

5.14**Advanced Mode: LIVEPAGE Functions**

LIVEPAGE Functions	
Show alarm inputs	<input checked="" type="checkbox"/>
Show relay outputs	<input checked="" type="checkbox"/>
Show VCA trajectories	<input type="checkbox"/>
Show VCA metadata	<input type="checkbox"/>
Show event log	<input checked="" type="checkbox"/>
Show system log	<input checked="" type="checkbox"/>
Allow snapshots	<input checked="" type="checkbox"/>
Allow local recording	<input checked="" type="checkbox"/>
Path for JPEG and video files	<input type="text" value="C:\"/> <input type="button" value="Browse"/>
<input type="button" value="Set"/>	

On this page you can adapt the **LIVEPAGE** functions to your requirements. You can choose from a variety of different options for displaying information and controls.

1. Check the box for the items that are to be made available on the **LIVEPAGE**. The selected items are indicated by a check mark.
2. Check whether the required functions are available on the **LIVEPAGE**.

Show alarm inputs

Alarm inputs are shown next to the video image as icons, along with their assigned names. If an alarm is active, the corresponding icon changes color.

Show relay outputs

Relay outputs are shown next to the video image as icons, along with their assigned names. If the relay is switched, the icon changes color.

Show VCA trajectories

The trajectories (motion lines of objects) from the video content analysis are displayed in the live video image if a corresponding analysis type is activated (see *Section 5.28 Advanced Mode: VCA Event triggered, page 62*).

Show VCA metadata

When the analysis function is activated, the additional information from the video content analysis (VCA) will be displayed in the live video image (see *Section 5.28 Advanced Mode: VCA Event triggered, page 62*). With the **MOTION+** analysis type, for example, the sensor fields in which motion is recorded will be marked with rectangles.

Show event log

The event messages are displayed along with the date and time in a field next to the video image.

Show system log

The system messages are displayed along with the date and time in a field next to the video image and provide information about establishing and ending connections, for example.

Allow snapshots

Here you can specify whether the icon for saving individual images should be displayed below the live image. Individual images can only be saved if this icon is visible.

Allow local recording

Here you can specify whether the icon for saving video sequences on the local memory should be displayed below the live image. Video sequences can only be saved if this icon is visible.

Path for JPEG and video files

1. Enter the path for the storage location of individual images and video sequences that you can save from the **LIVEPAGE**.
2. If necessary, click **Browse** to find a suitable directory.

5.15**Advanced Mode: Logging**

Logging	
Save event log	<input type="checkbox"/>
File for event log	C:\ <input type="button" value="Browse"/>
Save system log	<input type="checkbox"/>
File for system log	C:\ <input type="button" value="Browse"/> <input type="button" value="Set"/>

Save event log

Check this option to save event messages in a text file on your local computer. You can then view, edit and print this file with any text editor or the standard Office software.

File for event log

1. Enter the path for saving the event log here.
2. If necessary, click **Browse** to find a suitable directory.

Save system log

Check this option to save system messages in a text file on your local computer.

You can then view, edit and print this file with any text editor or the standard Office software.

File for system log

1. Enter the path for saving the system log here.
2. If necessary, click **Browse** to find a suitable directory.

5.16 Advanced Mode: Picture Settings



You can set the polarity of the thermal image of the camera to suit your requirements. The current video image is displayed in the small window next to the radio buttons as confirmation. Your changes are effective immediately.

1. Select the required polarity.
2. Click **View Control...** under the video window to control the camera when mounted on a pan/tilt.

5.17 Advanced Mode: Encoder Profile

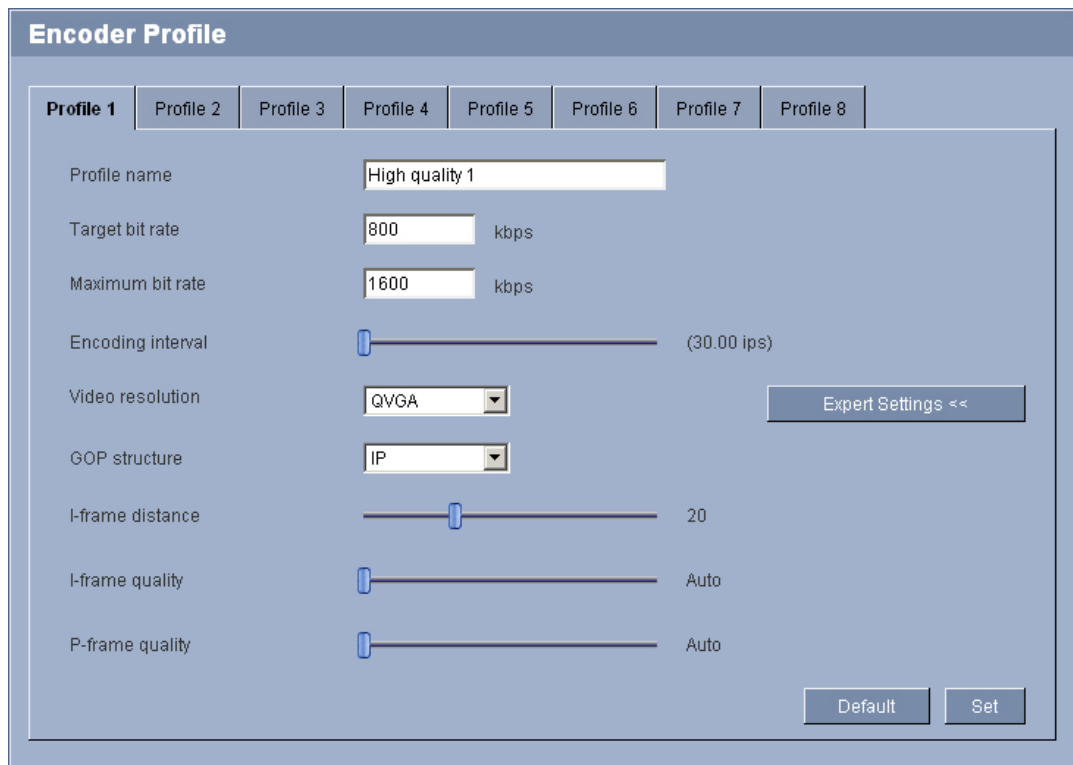

You can change the names and individual parameter values for the encoder profiles. You can use this to adapt the video data transmission to the operating environment (for example network structure, bandwidth, data load).

Pre-programmed profiles are available, each giving priority to different perspectives. Below is a brief description of the factory default settings for the encoder profiles.

- **High quality 1**
For high bandwidth connections with IBBP GOP structure
- **High quality 2**
For high bandwidth connections with IP GOP structure
- **Low bandwidth**
For low bandwidth connections with IP GOP structure
- **DSL**
For DSL connections with 500 kbps
- **ISDN (2B)**
For ISDN connections via two B-channels
- **ISDN (1B)**
For ISDN connections via one B-channel
- **MODEM**
For analog modem connections with 20 kbps
- **GSM**
For GSM connections at 9,600 baud



CAUTION!

Change the profiles only once you are fully familiar with all the configuration options. In the default setting, Stream 1 is transmitted for alarm connections and automatic connections. Bear this fact in mind when assigning the profile.



NOTICE!

All parameters combine to make up a profile and are dependent on one another. If you enter a setting that is outside the permitted range for a particular parameter, the nearest permitted value will be substituted when the settings are saved.

Profile name

You can enter a new name for the profile. The name is then displayed in the **Non-recording profile** list field on the **Encoder Streams** page in the lists of selectable profiles.



CAUTION!

Do not use any special characters, for example **&**, in the name. Special characters are not supported by the system's internal management.

Target bit rate

You can limit the bit rate for the VOT-320 to optimize utilization of the bandwidth in your network. The target bit rate should be set according to the desired picture quality for typical scenes with no excessive motion.

For complex images or frequent changes of image content due to frequent movements, this limit can be temporarily exceeded up to the value entered in the **Maximum bit rate** field.

Maximum bit rate

This maximum bit rate is not exceeded under any circumstances. Depending on the video quality settings for the I and P-frames, this fact can result in individual images being skipped. The value entered here must be at least 10% higher than the value entered in the **Target bit rate** field. If the value entered here is too low, it will automatically be adjusted.

Encoding interval

The setting selected here determines the interval at which images are encoded and transmitted. The image rate in ips (images per second) is displayed next to the text field.

Video resolution

Here you can select the desired resolution for the video image. At present only the following resolution is available:

- **QVGA**
320 × 240 pixels

Expert Settings

You can use the expert settings to adapt the I-frame quality and the P-frame quality to specific requirements, if necessary. The setting is based on the H.264 quantization parameter (QP).

GOP structure

Select the structure you require for the Group of Pictures here. Depending on whether you place greater priority on having the lowest possible delay (IP frames only) or using as little bandwidth as possible, you can choose between IP, IBP, and IBBP.

I-frame distance

This parameter allows you to set the intervals in which the I-frames will be coded. With the **Auto** setting, the encoder inserts I-frames as necessary. An entry of **3** indicates that only every third image is an I-frame; the frames in between are coded as P-frames.

I-frame quality

This setting sets the image quality of the I-frames. Select **Auto** to ensure that the maximum bit rate is not exceeded. **Auto** automatically follows the P-frame image quality.

P-frame quality

This setting adjusts the maximum image quality of the P-frames. **Auto** automatically adjusts to the optimum combination of movement and image definition (focus).

The value **9** represents maximum image quality, a value of **51** represents minimum quality.

With the slide control, define a control range from a chosen value to **51**. The encoder delivers the best possible quality within this control range while maintaining the maximum bit rate.

Default

Click **Default** to return the profile to the factory default values.

5.18 Advanced Mode: Encoder Streams



The VOT-320 simultaneously generates two H.264 data streams (Dual Streaming); you can select the relevant property for these here and connect them to an encoder profile, for example one for transmissions to the Internet and one for LAN connections.

Two settings with different encoder properties are available:

- **H.264 BP+ bit-rate-limited**
 Select this setting when using hardware decoders or the Divar XF digital video recorder. The bit rate is limited to 1.2 Mbps.
 CABAC: off
 CAVLC: on
 GOP structure: IP
 I-frame distance: 15
 Deblocking filter: on
- **H.264 MP SD**
 Select this setting when using software decoders, PT and for rapid movements in the images.
 CABAC: on
 CAVLC: off
 GOP structure: IP
 I-frame distance: 30
 Deblocking filter: on



CAUTION!

Hardware decoders VIP XD and VIP X1600 XFMD can only process algorithm H.264 BP+. Bear this in mind when configuring profile settings.

1. Select the required encoder properties and one of the encoder profiles for each data stream.
2. Click the **Preview** button. The preview screens for both data streams are shown.

3. Click the **1:1 Live View** button below the preview screen to open a new window with the original data stream and to check the image quality and the transmission rate.

Property

Select the required encoder properties for the relevant data stream here.

Non-recording profile

Select the required encoder profile here. The properties of the profiles are defined on the **Encoder Profile** page (see *Section 5.17 Advanced Mode: Encoder Profile, page 40*).

JPEG stream

You can set up the separate JPEG stream in this area. These settings are independent of the H.264 settings. The resolution corresponds to the highest setting from the two data streams.

Max. frame rate

You can select the maximum frame rate for transmitting the JPEG images.

Picture quality

This setting allows you to define the picture quality. Low quality requires a lower bandwidth in the network.

5.19 Advanced Mode: Storage Management

Storage Management

Device manager

Managed by external VRM

Recording media

iSCSI Media Local Media

iSCSI IP address

Password

Storage overview

- [-] 192.168.0.123
 - [-] DX 0 - iqn.2007-01.com.bosch.de:fwm.iscsi.disk1
 - LUN 0 - Size 10000 MB - Locked by iqn.2005-12.com.bosch:uvm00075f71ca30
 - LUN 1 - Size 40000 MB - Locked by iqn.2005-12.com.bosch:uvm00075f71410ae
 - LUN 2 - Size 30000 MB - Owner
 - [-] DX 1 - iqn.2007-01.com.bosch.de:fwm.iscsi.disk0
 - LUN 0 - Size 10000 MB - Locked by iqn.2005-12.com.bosch:uvm00075f75a527
 - LUN 1 - Size 10000 MB - Locked by iqn.2005-12.com.bosch:uvm00075f71dc99

Managed storage media

Target	Media Type	Size [MB]	Status	Rec. 1	Rec. 2
192.168.0.123 / 0 / 2	iSCSI system	29696	Online	<input checked="" type="checkbox"/>	<input type="checkbox"/>

Overwrite older recordings Recording 1 Recording 2

You can record the images from the camera on the local SD card or on an appropriately configured iSCSI system.

SD cards are the ideal solution for shorter storage times and temporary recordings, for example alarm recordings or local buffering in the event of network interruptions.

For long-term, authoritative images, it is essential that you use an appropriately sized iSCSI system.

It is also possible to let the VRM Video Recording Manager control all recording when accessing an iSCSI system. This is an external program for configuring recording tasks for videos. For further information please contact your local customer service at Bosch Security Systems.

Device manager

If you activate the **VRM** option in this screen, the VRM Video Recording Manager will manage all recording and you will not be able to configure any further settings here.



CAUTION!

Activating or deactivating VRM causes the current settings to be lost; they can only be restored through reconfiguration.

Recording media

Select the required recording media here so that you can then activate them and configure the recording parameters.

iSCSI Media

If you want to use an iSCSI system as a recording medium, you must set up a connection to the required iSCSI system and set the configuration parameters.

**NOTICE!**

The iSCSI storage system selected must be available on the network and completely set up. Amongst other things, it must have an IP address and be divided into logical drives (LUN).

1. Enter the IP address of the required iSCSI target in the **iSCSI IP address** field.
2. If the iSCSI target is password protected, enter this into the **Password** field.
3. Click the **Read** button. The connection to the IP address will be established. In the **Storage overview** field, you can see the corresponding logical drives.

Local Media

The supported local recording media are displayed in the **Storage overview** field.

Activating and configuring storage media

The storage overview displays the available storage media. You can select individual media or iSCSI drives and transfer these to the **Managed storage media** list. You can activate the storage media in this list and configure them for storage.

**CAUTION!**

Each storage medium can only be associated with one user. If a storage medium is already being used by another user, you can decouple the user and connect the drive with the VOT-320. Before decoupling, make absolutely sure that the previous user no longer needs the storage medium.

1. In the **Recording media** section, click the **iSCSI Media** and **Local Media** tabs to display the applicable storage media in the overview.
2. In the **Storage overview** section, double-click the required storage medium, an iSCSI LUN or one of the other available drives. The medium is then added to the **Managed storage media** list. In the **Status** column, newly added media are indicated by the status **Not active**.
3. Click the **Set** button to activate all media in the **Managed storage media** list. In the **Status** column, these are indicated by the status **Online**.
4. Check the box in the **Rec. 1** or **Rec. 2** column to specify which data stream should be recorded on the storage media selected. **Rec. 1** stores Stream 1, **Rec. 2** stores Stream 2. This means that you can record the standard data stream on a hard drive and record alarm images on the local SD card, for example.
5. Check the boxes for the **Overwrite older recordings** option to specify which older recordings can be overwritten once all the available memory capacity has been used. **Recording 1** corresponds to Stream 1, **Recording 2** corresponds to Stream 2.

**CAUTION!**

If older recordings are not allowed to be overwritten when the available memory capacity has been used, the recording in question will be stopped. You can specify limitations for overwriting old recordings by configuring the retention time (see *Section 5.21 Advanced Mode: Retention Time, page 50*).

Formatting storage media

You can delete all recordings on a storage medium at any time.



CAUTION!

Check the recordings before deleting and back up important sequences on the computer's hard drive.

-
1. Click a storage medium in the **Managed storage media** list to select it.
 2. Click the **Edit** button below the list. A new window will open.
 3. Click the **Formatting** button to delete all recordings in the storage medium.
 4. Click **OK** to close the window.

Deactivating storage media

You can deactivate any storage medium from the **Managed storage media** list. It is then no longer used for recordings.

1. Click a storage medium in the **Managed storage media** list to select it.
2. Click the **Remove** button below the list. The storage medium is deactivated and removed from the list.

5.20 Advanced Mode: Recording Profiles

Recording Profiles

Day Night Weekend Basic

Stream profile settings

Stream 1 Low bandwidth

Stream 2 Low bandwidth

Settings for selected streams

Camera	Recording	Standard recording	Alarm recording
Camera 1	1	Stream 1	Stream 1
Camera 1	2	Stream 2	Stream 2

Recording includes Metadata

Standard recording Continuous Stream Stream 1

Alarm recording

Pre-alarm time 0 s

Post-alarm time 0 s

Alarm stream Stream 1

with encoding interval from profile: High quality 1

Export to FTP [Configure FTP server](#)

Alarm triggers

Alarm input 1 2

Motion/Audio alarm 1

Video loss alarm 1

Virtual alarm 1 2 3 4

Copy Settings Default Set

You can define up to ten different recording profiles. You will then use these recording profiles in the recording scheduler, where they are linked with the individual days and times (see [Section 5.22 Advanced Mode: Recording Scheduler, page 51](#)).



NOTICE!

You can change or add to the recording profile description on the tabs on the **Recording Scheduler** page (see [Section Time periods, page 52](#)).

1. Click one of the tabs to edit the corresponding profile.
2. If necessary, click the **Default** button to return all settings to their default values.
3. Click the **Copy Settings** button if you want to copy the currently visible settings to other profiles. A new window will open and you can select the profiles in which you want to copy the settings.
4. For each profile, click the **Set** button to save the settings in the camera.

Stream profile settings

You can select the profile setting that is to be used for each data stream in the event of recordings. This selection is independent of the selection for live data stream transmission (see [Section 5.18 Advanced Mode: Encoder Streams, page 43](#)).

The properties of the profiles are defined on the **Encoder Profile** page (see [Section 5.17 Advanced Mode: Encoder Profile, page 40](#)).

Settings for selected streams

The settings in this settings group only refer to the streams selected in the list field. You can select both streams.

Recording includes

You can specify whether, in addition to video data, metadata (for example alarms, VCA data and serial data) should also be recorded. Including metadata could make subsequent searches of recordings easier but it requires additional memory capacity.



CAUTION!

Without metadata, it is not possible to include video content analysis in recordings.

Standard recording

Here you can select the mode for standard recordings.

If you select **Continuous**, the recording proceeds continuously. If the maximum memory capacity is reached, older recordings will automatically be overwritten. If you select the **Pre-alarm** option, the unit uses a special recording mode for optimal usage of storage capacity: As soon as a time window for alarm recording begins, recording takes place continuously on one segment that corresponds in size to a complete alarm sequence (pre- and post-alarm time). This segment functions in a similar manner to a ring buffer and is overwritten until an alarm is actually triggered. Then, recording occurs on the segment only for the duration of the preset post-alarm time and a new segment is subsequently used in the same manner.

If you select **Off**, no automatic recording takes place.



CAUTION!

You can specify limitations for overwriting older recordings in **Continuous** mode by configuring the retention time (see *Section 5.21 Advanced Mode: Retention Time, page 50*).

Stream

Here you can select the data stream that is to be used for standard recordings. You can select the data stream for alarm recordings separately and independently of this (see *Section Alarm stream, page 49*).

Pre-alarm time

You can select the required pre-alarm time from the list field. This parameter is only accessible if you have selected the **Pre-alarm** option under **Standard recording**.

Post-alarm time

You can select the required post-alarm time from the list field.

Alarm stream

Here you can select the data stream that is to be used for alarm recordings. You can select the data stream for standard recordings separately and independently of this (see *Section Stream, page 49*).

with encoding interval from profile

You can select an alternative encoding interval for the data stream for alarm recordings. Otherwise the encoding interval of the selected encoder profile is used (see *Section 5.17 Advanced Mode: Encoder Profile, page 40*).

Export to FTP

Select this parameter if you want all alarm recordings to be exported to an FTP server automatically. Make sure to have inserted all relevant data for FTP posting (see *Section 5.37 Advanced Mode: FTP Posting, page 76*).

Alarm input / Motion/Audio alarm / Video loss alarm

Here you can select the alarm sensor that is to trigger a recording.

**NOTICE!**

The alarm inputs are configured and activated on the **Alarm Inputs** page (see *Section 5.31 Advanced Mode: Alarm Inputs, page 66*).

The numbering of the checkboxes for the alarm inputs corresponds to the labeling of the alarm inputs on the VOT-320.

The motion alarm is configured and activated on the **VCA** page (see *Section 5.25 Advanced Mode: VCA, page 56 onwards*).

Virtual alarm

Here you can select the virtual alarm sensors that are to trigger a recording, via RCP+ commands or alarm scripts, for example.

**NOTICE!**

For more information, please see the **Alarm Task Script Language** document and the RCP+ documentation. These documents can be found on the product CD supplied.

5.21**Advanced Mode: Retention Time**

You can specify the retention times for recordings. If the available memory capacity of a medium has been used, older recordings are only overwritten if the retention time entered here has expired.

**NOTICE!**

Make sure that the retention time corresponds with the available memory capacity. A rule of thumb for the memory requirement is as follows: 1 GB per hour retention time with 4CIF for complete frame rate and high image quality.

Recording 1 / Recording 2

Enter the required retention time in hours or days for each recording. **Recording 1** corresponds to Stream 1, **Recording 2** corresponds to Stream 2.

5.22 Advanced Mode: Recording Scheduler

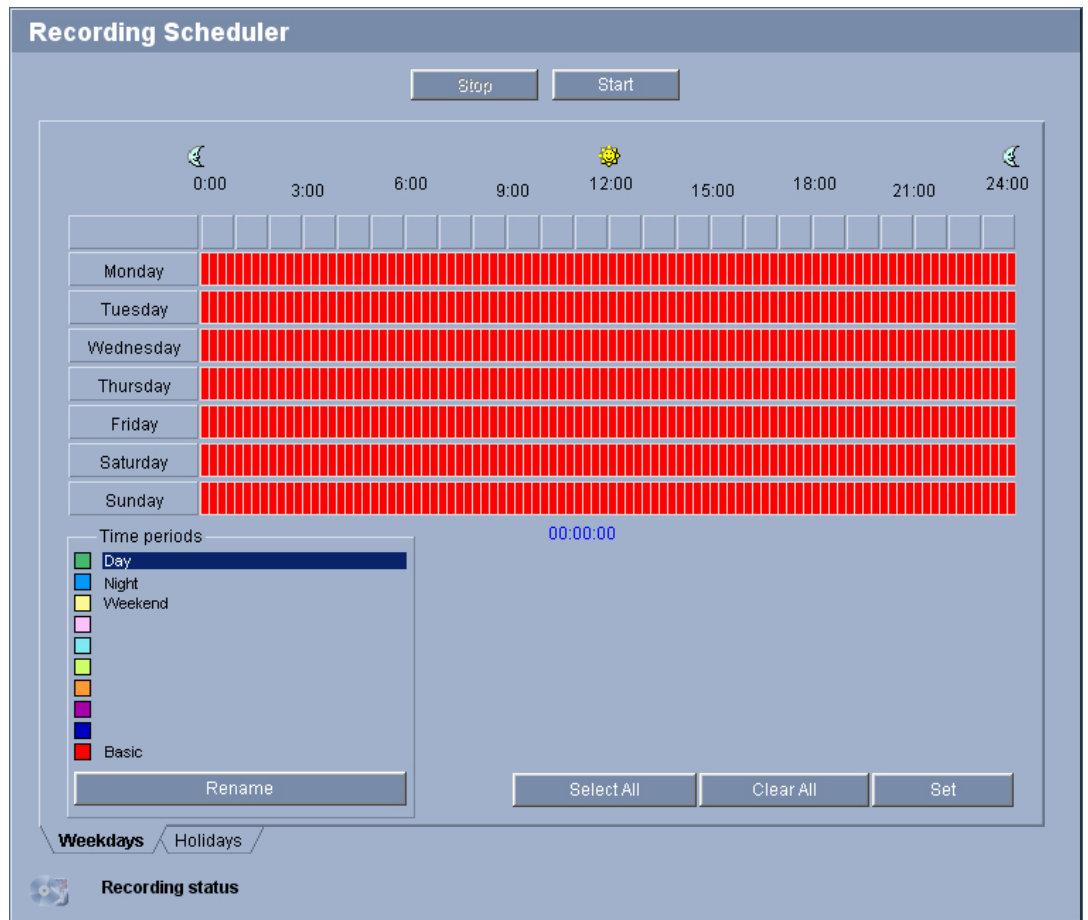

The recording scheduler allows you to link the created recording profiles with the days and times at which the camera's images are to be recorded in the event of an alarm. You can link any number of 15-minute intervals with the recording profiles for each day of the week. Moving the mouse cursor over the table displays the time below it. This aids orientation.

In addition to the normal weekdays, you can define holidays that are not in the standard weekly schedule on which recordings are to apply. This allows you to apply a schedule for Sundays to other days with dates that fall on varying weekdays.

1. Click the profile you want to link in the **Time periods** field.
2. Click in a field in the table, hold down the mouse button and drag the cursor over all the periods to be assigned to the selected profile.
3. Use the right mouse button to deselect any of the intervals.
4. Click the **Select All** button to link all time intervals to the selected profile.
5. Click the **Clear All** button to deselect all of the intervals.
6. When you are finished, click the **Set** button to save the settings in the camera.

Holidays

You can define holidays that are not in the standard weekly schedule on which recordings are to apply. This allows you to apply a schedule for Sundays to other days with dates that fall on varying weekdays.

1. Click the **Holidays** tab. Any days that have already been selected will be shown in the table.
2. Click the **Add** button. A new window will open.
3. Select the desired date from the calendar. You can select several consecutive calendar days by holding down the mouse button. These will later be displayed as a single entry in the table.
4. Click **OK** to accept the selection. The window will close.
5. Assign the individual holidays to the recording profiles, as described above.

Deleting holidays

You can delete holidays you have defined yourself at any time.

1. Click the **Delete** button. A new window will open.
2. Click the date you wish to delete.
3. Click **OK**. The item will be deleted from the table and the window will close.
4. The process must be repeated for deleting additional days.

Time periods

You can change the names of the recording profiles.

1. Click a profile and then the **Rename** button.
2. Enter your chosen name and then click the **Rename** button again.

Activating the recording

After completing configuration you must activate the recording scheduler and start the recording. The configuration can be changed at any time.

1. Click **Start** to activate the recording scheduler.
2. Click **Stop** to deactivate the recording scheduler. Running recordings are interrupted.

Recording status

The graphic indicates the recording activity of the VOT-320. You will see an animated graphic while recording is taking place.

5.23 Advanced Mode: Recording Status

Recording Status		
	Recording 1	Recording 2
Status	Offline	Offline
Last error	None	None
Recording target	0.0.0.0	0.0.0.0
Media		
Bit rate	0 kbps	0 kbps

Certain details on the recording status are displayed here for information purposes. You cannot change any of these settings.

5.24 Advanced Mode: Alarm Connections

Alarm Connections	
Connect on alarm	Off
Number of destination IP address	1
Destination IP address	0.0.0.0
Destination password	
Video transmission	UDP
Stream	1
Remote port	80
Video output	First available
Decoder	First available
SSL encryption	Off
Auto-connect	Off
<input type="button" value="Set"/>	

You can select how the VOT-320 responds to an alarm. In the event of an alarm, the camera can automatically connect to a pre-defined IP address. You can enter up to ten IP addresses to which the VOT-320 will connect in sequence in the event of an alarm, until a connection is made.

Connect on alarm

Select **On** so that the VOT-320 automatically connects to a predefined IP address in the event of an alarm.

By setting **Follows input 1** the camera maintains the connection that has been automatically established for as long as an alarm exists on alarm input 1.

**NOTICE!**

In the default setting, Stream 1 is transmitted for alarm connections. Bear this fact in mind when assigning the profile (see *Section 5.17 Advanced Mode: Encoder Profile, page 40*).

Number of destination IP address

Specify the numbers of the IP addresses to be contacted in the event of an alarm. The camera contacts the remote stations one after the other in the numbered sequence until a connection is made.

Destination IP address

For each number, enter the corresponding IP address for the desired remote station.

Destination password

If the remote station is password protected, enter the password here.

In this page, you can save a maximum of ten destination IP addresses and hence up to ten passwords for connecting to remote stations. If connections to more than ten remote stations are to be possible, for example when initiating connections via higher-ranking systems such as Bosch Video Client or Bosch Video Management System, you can store a general password here. The VOT-320 can use this general password to connect to all remote stations protected with the same password. In this case, proceed as follows:

1. In the **Number of destination IP address** list field, select **10**.
2. Enter the address **0.0.0.0** in the **Destination IP address** field.
3. Enter your chosen password in the **Destination password** field.
4. Define this password as the **user** password for all remote stations to which a connection is to be possible.

**NOTICE!**

If you enter the destination IP address 0.0.0.0 for destination 10, the VOT-320 will no longer use this address for the tenth attempt at automatic connection in the event of an alarm. The parameter is then used only to save the general password.

Video transmission

If the camera is operated behind a firewall, **TCP (HTTP port)** should be selected as the transfer protocol. For use in a local network, select **UDP**.

**CAUTION!**

Please note that in some circumstances, a larger bandwidth must be available on the network for additional video images in the event of an alarm, in case multicast operation is not possible. To enable multicast operation, select the **UDP** option for the **Video transmission** parameter here and on the **Network** page (see *Section Video transmission, page 70*).

Stream

Select the stream for transmission in case of an alarm.

Remote port

Depending on the network configuration, select a browser port here. The ports for HTTPS connections will be available only if the **On** option is selected in the **SSL encryption** parameter.

Video output

If you know which unit is being used as the receiver, you can select the analog video output to which the signal should be switched. If the destination unit is unknown, it is advisable to select the **First available** option. In this case, the image is placed on the first free video output. This is an output on which there is no signal. The connected monitor only displays images when an alarm is triggered. If you select a particular video output and a split image is set for this output on the receiver, you can also select from **Decoder** the decoder in the receiver that is to be used to display the alarm image.

**NOTICE!**

Refer to the destination unit documentation concerning image display options and available video outputs.

Decoder

Select a decoder of the receiver to display the alarm image. The decoder selected has an impact on the position of the image in a split screen. For example, you can specify that the upper-right quadrant should be used to display the alarm image on a VIP XD by selecting Decoder 2.

SSL encryption

The data for the connection, for example the password, can be securely transmitted with SSL encryption. If you have selected the **On** option, only encrypted ports are offered in the **Remote port** parameter.

**NOTICE!**

Please note that the SSL encryption must be activated and configured at both ends of a connection. This requires the appropriate certificates to be uploaded onto the VOT-320 (see *Section SSL certificate, page 79*).

You can activate and configure encryption of the media data (video and metadata) on the **Encryption** page (see *Section 5.38 Advanced Mode: Encryption, page 77*).

Auto-connect

Select the **On** option to automatically re-establish a connection to one of the previously specified IP addresses after each reboot, after a connection breakdown or after a network failure.

**NOTICE!**

In the default setting, Stream 1 is transmitted for automatic connections. Bear this fact in mind when assigning the profile (see *Section 5.17 Advanced Mode: Encoder Profile, page 40*).

5.25 Advanced Mode: VCA

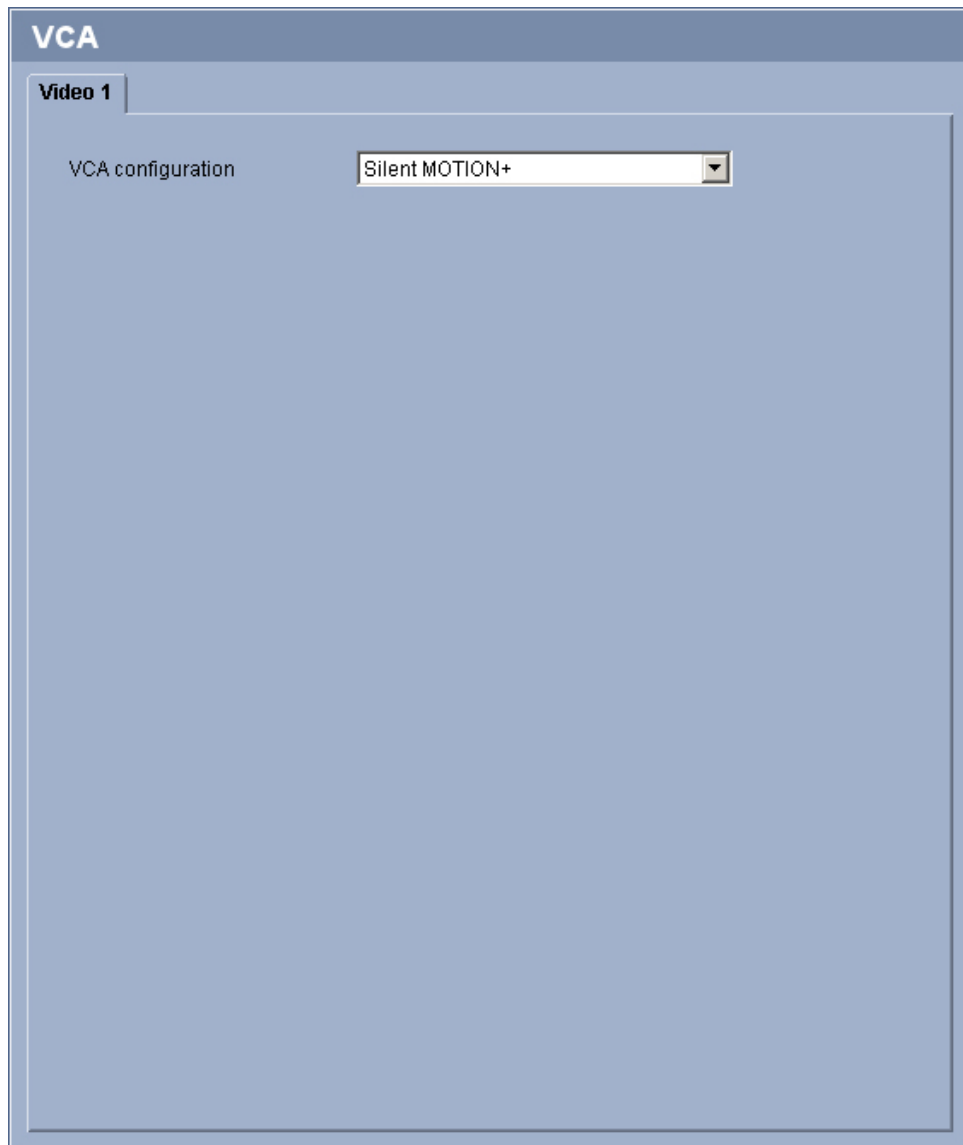

The VOT-320 contains an integrated video content analysis (VCA), which can detect and analyze changes in the signal using image processing algorithms. Such changes can be due to movements in the camera's field of view.

You can select various VCA configurations and adapt these to your application as required.

The **Silent MOTION+** configuration is active by default. In this configuration, metadata is created to facilitate searches of recordings; however, no alarm is triggered.

You can switch off the video content analysis completely if the device's full power is to be made available for the encoder.

1. Select a VCA configuration and make the required settings.
2. If necessary, click the **Default** button to return all settings to their default values.

5.26 Advanced Mode: VCA profiles

VCA

Video 1

VCA configuration: Profile #1

Alarm status: Off

Aggregation time [s]: 0

Analysis type: MOTION+

Motion detector

Sensitivity: 100

Minimum object size: 4

Debounce time 1 s:

Tamper detection

Global change: 50

Global change

Scene too noisy

Buttons: Load... Save... Default Set

You can configure two profiles with different VCA configurations. You can save profiles on your computer's hard drive and load saved profiles from there. This can be useful if you want to test a number of different configurations. Save a functioning configuration and test new settings. You can use the saved configuration to restore the original settings at any time.

1. Select a VCA profile and enter the required settings.
2. If necessary, click the **Default** button to return all settings to their default values.
3. Click the **Save...** button to save the profile settings to a file. A new window is opened, in which you can specify where you want to save the file and what name you want to save it under.
4. Click the **Load...** button to load a saved profile. A new window opens in which you can select the profile file and specify where to save the file.

VCA configuration

Select one of the profiles here to activate it or edit it.

You can rename the profile.



CAUTION!

Do not use any special characters, for example **&**, in the name.

Special characters are not supported by the system's internal management.

1. To rename the file, click the icon to the right of the list field and enter the new profile name in the field.
2. Click the icon again. The new profile name is saved.

Alarm status

The alarm status is displayed here for information purposes. This means you can check the effects of your settings immediately.

Aggregation time [s]

You can set an aggregation time of between 0 and 20 seconds if necessary. The aggregation time always starts when an alarm event occurs. It extends the alarm event by the value set. This prevents alarm events that occur in quick succession from triggering several alarms and successive events in a rapid sequence. No further alarm is triggered during the aggregation time.

Note that the value for the pre-alarm time must be greater than the value for the aggregation time, so that also the alarm event is recorded. The post-alarm time set for alarm recordings only starts once the aggregation time has expired (see *Section 5.20 Advanced Mode: Recording Profiles, page 48*).

Analysis type

Select the required analysis algorithm. By default, **MOTION+** and **IVA** are available.

IVA is an analysis algorithm with comprehensive functions. One of the benefits of using IVA is that it postpones the automatic flat-field correction FFC if an object is tracked to up to 1.5 hours or 3 Kelvin temperature difference. For further information on **IVA** refer to the relevant manual on the product CD supplied.

MOTION+ offers a motion detector and essential recognition of tampering. The corresponding parameters are described in the text below.

Metadata is always created for a video content analysis, unless this was explicitly excluded.

Depending on the analysis type selected and the relevant configuration, additional information overlays the video image in the preview window next to the parameter settings. With the **MOTION+** analysis type, for example, the sensor fields in which motion is recorded will be marked with rectangles.



NOTICE!

On the **LIVEPAGE Functions** page, you can also enable additional information overlays for the **LIVEPAGE** (see *Section 5.14 Advanced Mode: LIVEPAGE Functions, page 38*).

Motion detector (MOTION+ only)

For the detector to function, the following conditions must be met:

- Analysis must be activated.
- At least one sensor field must be activated.
- The individual parameters must be configured to suit the operating environment and the desired responses.
- The sensitivity must be set to a value greater than zero.

**CAUTION!**

Reflections of light (off glass surfaces, etc.), switching lights on or off or changes in the light level caused by cloud movement on a sunny day can trigger unintended responses from the motion detector and generate false alarms. Run a series of tests at different times of the day and night to ensure that the video sensor is operating as intended.

For indoor surveillance, ensure constant lighting of the areas during the day and at night.

Sensitivity (MOTION+ only)

The basic sensitivity of the motion detector can be adjusted for the environmental conditions to which the camera is subject.

The sensor reacts to variations in the brightness of the video image. The darker the observation area, the higher the value that must be selected.

Minimum object size (MOTION+ only)

You can specify the number of sensor fields that a moving object must cover to generate an alarm. This is to prevent objects that are too small from triggering an alarm.

A minimum value of **4** is recommended. This value corresponds to four sensor fields.

Debounce time 1 s (MOTION+ only)

The debounce time is intended to prevent very brief alarm events from triggering individual alarms. If the **Debounce time 1 s** option is activated, an alarm event must last at least one second to trigger an alarm.

Select Area (MOTION+ only)

The areas of the image to be monitored by the motion detector can be selected. The video image is subdivided into square sensor fields. Each of these fields can be activated or deactivated individually. If you wish to exclude particular regions of the camera's field of view from monitoring due to continuous movement (by a tree in the wind, etc.), the relevant fields can be deactivated.

1. Click **Select Area** to configure the sensor fields. A new window will open.
2. If necessary, click **Clear All** first to clear the current selection (fields marked yellow).
3. Left-click the fields to be activated. Activated fields are marked yellow.
4. If necessary, click **Select All** to select the entire video frame for monitoring.
5. Right-click any fields you wish to deactivate.
6. Click **OK** to save the configuration.
7. Click the close button **X** in the window title bar to close the window without saving the changes.

Global change

You can set how large the global change in the video image must be for an alarm to be triggered. This setting is independent of the sensor fields selected under **Select Area**. Set a high value if fewer sensor fields need to change to trigger an alarm. With a low value, it is necessary for changes to occur simultaneously in a large number of sensor fields to trigger an alarm.

This option allows you to detect, independently of motion alarms, manipulation of the orientation or location of a camera resulting from turning the camera mount bracket, for instance.

Global change

Activate this function if the global change, as set with the **Global change** slide control, should trigger an alarm.

Scene too noisy

Activate this function if tampering associated with EMC interference (noisy scene as the result of a strong interference signal in the vicinity of the video lines), as an example, should trigger an alarm.

5.27 Advanced Mode: VCA Scheduled

The screenshot displays the VCA configuration interface for 'Video 1'. At the top, 'VCA configuration' is set to 'Scheduled' and 'Alarm status' is 'Off'. Below this, there are two tabs: 'Weekdays' (selected) and 'Holidays'. The main area is a grid for scheduling VCA profiles. The grid has columns for time slots (0:00, 3:00, 6:00, 9:00, 12:00, 15:00, 18:00, 21:00, 24:00) and rows for days of the week (Monday to Sunday). A legend at the bottom left shows 'Profile #1' with a green square and 'Profile #2' with a blue square. At the bottom right, there are three buttons: 'Select All', 'Clear All', and 'Set'. The time '23:30:00' is displayed in the grid area.

This configuration allows you to link the created VCA profile with the days and times at which the video content analysis is to be active.

You can link any number of 15-minute intervals with the VCA profiles for each day of the week. Moving the mouse cursor over the table displays the time below it. This aids orientation. In addition to the normal weekdays, you can define holidays that are not in the standard weekly schedule on which recordings are to apply. This allows you to apply a schedule for Sundays to other days with dates that fall on varying weekdays.

1. Click the profile you want to link in the **Time periods** field.
2. Click in a field in the table, hold down the mouse button and drag the cursor over all the periods to be assigned to the selected profile.
3. Use the right mouse button to deselect any of the intervals.
4. Click the **Select All** button to link all time intervals to the selected profile.
5. Click the **Clear All** button to deselect all of the intervals.
6. When you are finished, click the **Set** button to save the settings in the camera.

Holidays

You can define holidays on which a profile should be active that are different to the standard weekly schedule. This allows you to apply a schedule for Sundays to other days with dates that fall on varying weekdays.

1. Click the **Holidays** tab. Any days that have already been selected will be shown in the table.
2. Click the **Add** button. A new window will open.
3. Select the desired date from the calendar. You can select several consecutive calendar days by holding down the mouse button. These will later be displayed as a single entry in the table.
4. Click **OK** to accept the selection. The window will close.
5. Assign the individual holidays to the VCA profiles, as described above.

Deleting holidays

You can delete holidays you have defined yourself at any time.

1. Click the **Delete** button. A new window will open.
2. Click the date you wish to delete.
3. Click **OK**. The item will be deleted from the table and the window will close.
4. The process must be repeated for deleting additional days.

5.28 Advanced Mode: VCA Event triggered

The screenshot shows the VCA configuration interface for Video 1. The main configuration is set to 'Event triggered'. The Alarm status is 'Off'. The Configuration section includes:

- Trigger: Alarm input 1
- Trigger active: Silent MOTION+
- Trigger inactive: Silent MOTION+ (indicated with a green checkmark)
- Delay [s]: A slider set to 1 second.

A 'Set' button is located at the bottom right of the configuration area.

This configuration allows you stipulate that the video content analysis is only to be activated when triggered by an event. As long as no trigger is activated, the **Silent MOTION+** configuration in which metadata is created is active; this metadata facilitates searches of recordings, but does not trigger an alarm.

Trigger

You can select one of the physical alarms on the device's alarm inputs or one of the virtual alarms as a trigger. A virtual alarm is created using software, with RCP+ commands or alarm scripts, for example.



NOTICE!

For more information, please see the **Alarm Task Script Language** document and the RCP+ documentation. You can find these documents on the product CD supplied (see *Section 3.1 Parts included, page 10*).

Trigger active

Select the VCA configuration here that is to be enabled via an active trigger. A green check mark to the right of the list field indicates that the trigger is active.

Trigger inactive

Select the VCA configuration here that is to be activated if the trigger is not active. A green check mark to the right of the list field indicates that the trigger is inactive.

Delay [s]

Select the delay period here for the reaction of the video content analysis to trigger signals. The alarm is only triggered after a set time interval in seconds has elapsed and then only if the triggering condition still exists. If the original condition has been restored before this time interval elapses, the alarm is not triggered. A delay period may be useful in avoiding false alarms or frequent triggering, for example. During the delay period, the **Silent MOTION+** configuration is always enabled.

5.29**Advanced Mode: Alarm E-Mail**

As an alternative to automatic connecting, alarm states can also be documented by e-mail. In this way it is possible to notify a recipient who does not have a video receiver. In this case, the VOT-320 automatically sends an e-mail to a previously defined e-mail address.

Send alarm e-mail

Select **On** if you want the camera to automatically send an alarm e-mail in the event of an alarm.

Mail server IP address

Enter the IP address of a mail server that operates on the SMTP standard (Simple Mail Transfer Protocol). Outgoing e-mails are sent to the mail server via the address you entered. Otherwise leave the box blank (**0.0.0.0**).

SMTP user name

Enter a registered user name for the chosen mailserver here.

SMTP password

Enter the required password for the registered user name here.

Format

You can select the data format of the alarm message.

- **Standard (with JPEG)**
E-mail with JPEG image file attachment.
- **SMS**
E-mail in SMS format to an e-mail-to-SMS gateway (for example, to send an alarm by cell phone) without an image attachment.

**CAUTION!**

When a cell phone is used as the receiver, make sure to activate the e-mail or SMS function, depending on the format, so that these messages can be received.

You can obtain information on operating your cell phone from your cell phone provider.

Attach JPEG from camera

Click the checkbox to specify that JPEG images are sent from the camera.

Destination address

Enter the e-mail address for alarm e-mails here. The maximum address length is 49 characters.

Sender name

Enter a unique name for the e-mail sender, for example the location of the camera. This will make it easier to identify the origin of the e-mail.

Test e-mail

You can test the e-mail function by clicking the **Send Now** button. An alarm e-mail is immediately created and sent.

5.30 Advanced Mode: Alarm Task Editor

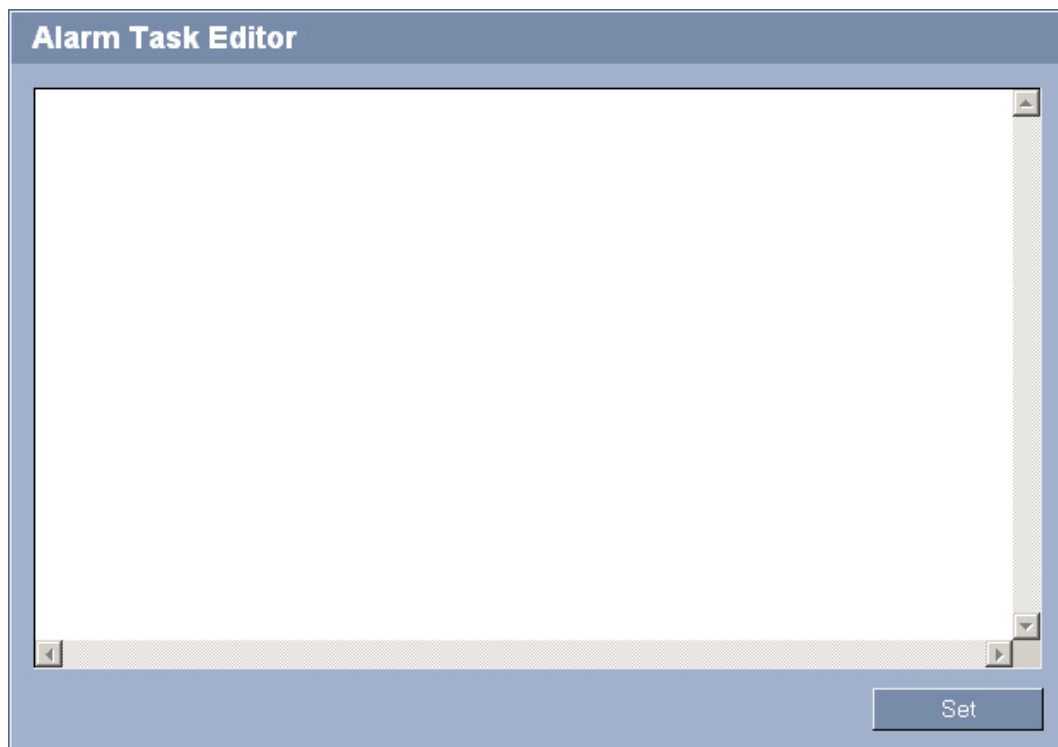

CAUTION!

Editing scripts on this page overwrites all settings and entries on the other alarm pages. This procedure cannot be reversed.

In order to edit this page, you must have programming knowledge and be familiar with the information in the **Alarm Task Script Language** document. You can find the document on the product CD supplied (see *Section 3.1 Parts included, page 10*).

As an alternative to the alarm settings on the various alarm pages, you can enter your desired alarm functions in script form here. This will overwrite all settings and entries on the other alarm pages.

1. Click the **Examples** link under the **Alarm Task Editor** field to see some script examples. A new window will open.
2. Enter new scripts in the **Alarm Task Editor** field or change existing scripts in line with your requirements.
3. When you are finished, click the **Set** button to transmit the scripts to the camera. If the transfer was successful, the message **Script successfully parsed.** is displayed over the text field. If it was not successful, an error message will be displayed with further information.

5.31 Advanced Mode: Alarm Inputs

Alarm Inputs

Alarm input 1	<input type="text" value="N.O."/>	Name	<input type="text" value="Input 1"/>
Alarm input 2	<input type="text" value="N.O."/>	Name	<input type="text" value="Input 2"/>

You can configure the alarm inputs of the VOT-320.

Alarm input

Select **N.O.** if the alarm is to be triggered when the contact closes. Select **N.C.** if the alarm is to be triggered when the contact opens.

Name

You can enter a name for each alarm input, which is then displayed below the icon for the alarm input on the **LIVEPAGE** if configured correctly (see *Section 5.14 Advanced Mode: LIVEPAGE Functions, page 38*). You can also use the name in the Forensic Search program function as a filter option for quick search in recordings.



CAUTION!

Do not use any special characters, for example **&**, in the name. Special characters are not supported by the system's internal management.

5.32 Advanced Mode: Relay

Relay

Idle state	<input type="text" value="Open"/>	<input type="text" value="Open"/>	
Operating mode	<input type="text" value="Bistable"/>	<input type="text" value="Bistable"/>	
Relay follows	<input type="text" value="Off"/>	<input type="text" value="Off"/>	
Relay name	<input type="text" value="Relay 1"/>	<input type="text" value="Relay 2"/>	
Trigger relay	<input type="button" value="Relay 1"/>	<input type="button" value="Relay 2"/>	

You can configure the switching behavior of the relay outputs. For each relay, you can specify an open switch relay (normally closed contact) or a closed switch relay (normally open contact).

You can also specify whether an output should operate as a bistable or monostable relay. In bistable mode, the triggered state of the relay is maintained. In monostable mode, you can set the time after which the relay will return to the idle state.

You can select different events that automatically activate an output. It is possible, for example, to turn on a floodlight by triggering a motion alarm and then turning the light off again when the alarm has stopped.

Idle state

Select **Open** if you want the relay to operate as an NO contact, or select **Closed** if the relay is to operate as an NC contact.

Operating mode

Select an operating mode for the relay.

For example, if you want an alarm-activated lamp to stay on after the alarm ends, select **Bistable**. If you wish an alarm-activated siren to sound for ten seconds, for example, select **10 s**.

Relay follows

If required, select a specific event that will trigger the relay. The following events are possible triggers:

- **Off**
Relay is not triggered by events
- **Connection**
Triggering when connection established
- **Video alarm**
Triggering by interruption of the video signal
- **Motion alarm**
Triggering by motion alarm, as configured on the **VCA** page (see *Section 5.28 Advanced Mode: VCA Event triggered, page 62*)
- **Local input**
Triggering by corresponding external alarm input
- **Remote input**
Triggering by remote station's corresponding switching contact (only if a connection exists)

**NOTICE!**

The numbers in the lists of selectable events relate to the corresponding connections on the camera, **Local input 1**, for example to the **IN1** connection.

Relay name

You can assign a name for the relay here. The name is shown on the button next to **Trigger relay**. The Livepage can also be configured to display the name under the relay icon. You can also use the name in the Forensic Search program function as a filter option for quick search in recordings.

**CAUTION!**

Do not use any special characters, for example **&**, in the name. Special characters are not supported by the system's internal management.

Trigger relay

Click the button to trigger the relay manually (for testing or to operate a door opener, for example).

5.33

Advanced Mode: COM1

COM1

Serial port function

Camera ID

Baud rate bps

Data bits

Stop bits

Parity check

Interface mode

You can configure the serial interface parameters (upper 6-pin terminal block) to meet your requirements.

**NOTICE!**

If the VOT-320 is working in multicast mode (see *Section 5.36 Advanced Mode: Multicast, page 75*), the first remote location to establish a video connection to the camera is also assigned the transparent data connection. However, after about 15 seconds of inactivity the data connection is automatically terminated and another remote location can exchange transparent data with the camera.

Serial port function

Select a controllable unit from the list. If you wish to use the serial port to transmit transparent data, select **Transparent**. Select **Terminal** if you wish to operate the unit from a terminal.

**NOTICE!**

After selecting a unit, the remaining parameters in the window are set automatically and should not be changed.

Camera ID

If necessary, enter the ID of the peripheral you wish to control (for example a pan/tilt).

Baud rate

Select the value for the transmission rate in bps.

Data bits

The number of data bits per character cannot be changed.

Stop bits

Select the number of stop bits per character.

Parity check

Select the type of parity check.

Interface mode

Select the desired protocol for the serial interface.

5.34 Advanced Mode: Network

Network

DHCP

Automatic IP assignment

Ethernet

IP address

Subnet mask

Gateway address

DNS server address

[Details <<](#)

Video transmission

HTTP browser port

HTTPS browser port

RCP+ port 1756

Telnet support

Interface mode ETH

Network MSS [Byte]

iSCSI MSS [Byte]

DynDNS

Enable DynDNS

Host name

User name

Password

Force registration now

Status DynDNS function switched off

The settings on this page are used to integrate the VOT-320 into an existing network.

Some changes only take effect after the camera is rebooted. In this case, the **Set** button changes to **Set and Reboot**.

1. Make the desired changes.
2. Click the **Set and Reboot** button. The VOT-320 is rebooted and the changed settings are activated.

**CAUTION!**

If you change the IP address, subnet mask or gateway address, the VOT-320 is only available under the new addresses after the reboot.

Automatic IP assignment

If a DHCP server is employed in the network for the dynamic assignment of IP addresses, you can activate acceptance of IP addresses automatically assigned to the VOT-320.

Certain applications (Bosch Video Client, Bosch Video Management System) use the IP address for the unique assignment of the camera. If you use these applications, the DHCP server must support the fixed assignment between IP address and MAC address, and must be appropriately set up so that, once an IP address is assigned, it is retained each time the system is rebooted.

IP address

Enter the desired IP address for the VOT-320 in this field. The IP address must be valid for the network.

Subnet mask

Enter the appropriate subnet mask for the selected IP address here.

Gateway address

If you want the camera to establish a connection to a remote location in a different subnet, enter the IP address of the gateway here. Otherwise leave the box blank (**0.0.0.0**).

DNS server address

The camera can use a DNS server to resolve a mail or FTP server address specified as a name. Enter the IP address of the DNS server here.

Video transmission

If the camera is operated behind a firewall, **TCP (HTTP port)** should be selected as the transfer protocol. For use in a local network, select **UDP**.

**CAUTION!**

Multicast operation is only possible with the UDP protocol. The TCP protocol does not support multicast connections.

The MTU value in UDP mode is 1,514 bytes.

HTTP browser port

Select a different HTTP browser port from the list if required. The default HTTP port is 80. If you want to allow only secure connections via HTTPS, you must deactivate the HTTP port. In this case, select **Off**.

HTTPS browser port

If you wish to allow browser access on the network via a secure connection, select an HTTPS browser port from the list if necessary. The default HTTPS port is 443. Select the **Off** option to deactivate HTTPS ports; only unsecured connections will now be possible.

The VOT-320 uses the TLS 1.0 encryption protocol. You may have to activate this protocol via your browser configuration. You must also activate the protocol for the Java applications (via the Java control panel in the Windows control panel).



NOTICE!

If you want to allow only secure connections with SSL encryption, you must select the **Off** option for each of the parameters **HTTP browser port**, **RCP+ port 1756** and **Telnet support**. This deactivates all unsecured connections. Connections will then only be possible via the HTTPS port.

You can activate and configure encryption of the media data (video and metadata) on the **Encryption** page (see *Section 5.38 Advanced Mode: Encryption, page 77*).

RCP+ port 1756

To exchange connection data, you can activate the unsecured RCP+ port 1756. If you want connection data to be transmitted only when encrypted, select the **Off** option to deactivate the port.

Telnet support

If you want to allow only secure connections with encrypted data transmission, you must select the **Off** option to deactivate Telnet support. The camera will then no longer be accessible using the Telnet protocol.

Interface mode ETH

If necessary, select the Ethernet link type for the Ethernet interface. Depending on the unit connected, it may be necessary to select a special operation type.

Network MSS [Byte]

You can set the maximum segment size for the IP packet's user data. This gives you the option to adjust the size of the data packets to the network environment and to optimize data transmission. Please comply with the MTU value of 1,514 bytes in UDP mode.

iSCSI MSS [Byte]

You can specify a higher MSS value for a connection to the iSCSI system than for the other data traffic via the network. The potential value depends on the network structure. A higher value is only useful if the iSCSI system is located in the same subnet as the VOT-320.

Enable DynDNS

DynDNS.org is a DNS hosting service that stores IP addresses in a database ready for use. It allows you to select the VOT-320 via the Internet using a host name, without having to know the current IP address of the camera. You can enable this service here. To do this, you must have an account with DynDNS.org and you must have registered the required host name for the camera on that site.



NOTICE!

Information about the service, registration process and available host names can be found at DynDNS.org.

Host name

Enter the host name registered on DynDNS.org for the VOT-320 here.

User name

Enter the user name you registered at DynDNS.org here.

Password

Enter the password you registered at DynDNS.org here.

Force registration now

You can force the registration by transferring the IP address to the DynDNS server. Entries that change frequently are not provided in the Domain Name System. It is a good idea to force the registration when you are setting up the device for the first time. Only use this function when necessary and no more than once a day, to avoid the possibility of being blocked by the service provider. To transfer the IP address of the VOT-320, click the **Register** button.

Status

The status of the DynDNS function is displayed here for information purposes. You cannot change any of these settings.

5.35 Advanced Mode: Advanced

Advanced

SNMP

SNMP

1. SNMP host address

2. SNMP host address

SNMP traps

802.1x

Authentication

Identity

Password

RTSP

RTSP port

UPnP

UPnP

TCP metadata input

TCP port

Sender IP address

The settings on this page are used to implement advanced settings for the network. Some changes only take effect after the camera is rebooted. In this case, the **Set** button changes to **Set and Reboot**.

1. Make the desired changes.
2. Click the **Set and Reboot** button. The VOT-320 is rebooted and the changed settings are activated.

SNMP

The VOT-320 supports the SNMP V2 (Simple Network Management Protocol) for managing and monitoring network components, and can send SNMP messages (traps) to IP addresses. The camera supports SNMP MIB II in the unified code. If you wish to send SNMP traps, enter the IP addresses of one or two required target devices here.

If you select **On** for the **SNMP** parameter and do not enter an SNMP host address, the VOT-320 does not send the SNMP traps automatically, but only replies to SNMP requests. If you enter one or two SNMP host addresses, SNMP traps are sent automatically. Select **Off** to deactivate the SNMP function.

1. SNMP host address / 2. SNMP host address

If you wish to send SNMP traps automatically, enter the IP addresses of one or two required target units here.

SNMP traps

You can select which traps are to be sent.

1. Click **Select**. A list is opened.
2. Click the checkboxes to select the required traps. All the checked traps will be sent.
3. Click **Set** to accept the selection.

Authentication

If a RADIUS server is employed in the network for managing access rights, authentication must be activated here to allow communication with the camera. The RADIUS server must also contain the corresponding data.

To configure the camera, you must connect the VOT-320 directly to a computer. This is because communication via the network is not enabled until the **Identity** and **Password** parameters have been set and successfully authenticated.

Identity

Enter the name that the RADIUS server is to use for identifying the VOT-320.

Password

Enter the password that is stored in the RADIUS server.

RTSP port

If necessary, select a different port for the exchange of the RTSP data from the list. The standard RTSP port is 554. Select **Off** to deactivate the RTSP function.

UPnP

You can activate the Universal Plug and Play (UPnP) function. If the function is turned on, the camera responds to requests from the network and is automatically registered on the requesting computers as a new network device. For example, access to the camera can then be made using Windows Explorer without knowledge of the IP address of the camera.



NOTICE!

To use the UPnP function on a computer, both the Universal Plug and Play Device Host and SSDP Discovery Service must be active in Windows XP and Windows Vista.

This function should not be used in large installations because of the variety of potential registration notifications.

TCP port

The device can receive data from an external TCP sender, for example an ATM or POS device, and store it as metadata. Select the port for TCP communication. Select **Off** to deactivate the TCP metadata function.

Sender IP address

Enter the IP address of the TCP metadata sender here.

5.36 Advanced Mode: Multicast

	Enable	Multicast Address	Port	Streaming
Video 1	<input type="checkbox"/>	0.0.0.0	60001	<input type="checkbox"/>

Stream 1 | Stream 2

Multicast packet TTL: 64

Set

In addition to a 1:1 connection between an encoder and a single receiver (unicast), the VOT-320 can enable multiple receivers to receive the video signal from an encoder simultaneously. The device either duplicates the data stream itself and then distributes it to multiple receivers (Multi-unicast) or it sends a single data stream to the network, where the data stream is simultaneously distributed to multiple receivers in a defined group (Multicast). You can enter a dedicated multicast address and port for each stream. You can switch between the streams by clicking the appropriate tabs.



NOTICE!

Multicast operation requires a multicast-enabled network that uses the UDP and the Internet Group Management IGMP protocols. Other group management protocols are not supported. The TCP protocol does not support multicast connections.

A special IP address (class D address) must be configured for multicast operation in a multicast-enabled network.

The network must support group IP addresses and the Internet Group Management Protocol (IGMP V2). The address range is from 225.0.0.0 to 239.255.255.255.

The multicast address can be the same for multiple streams. However, it will be necessary to use a different port in each case so that multiple data streams are not sent simultaneously using the same port and multicast address.



NOTICE!

The settings must be made individually for each stream.

Enable

To enable simultaneous data reception on several receivers you need to activate the multicast function. To do this, check the box. You can then enter the multicast address.

Multicast Address

Enter a valid multicast address for each stream to be operated in multicast mode (duplication of the data streams in the network).

With the setting **0.0.0.0** the encoder for the relevant stream operates in multi-unicast mode (copying of data streams in the camera). The VOT-320 supports multi-unicast connections for up to five simultaneously connected receivers.

**NOTICE!**

Duplication of data places a heavy demand on the camera and can lead to impairment of the image quality under certain circumstances.

Port

Assign a different port to each data stream if there are simultaneous data streams at the same multicast address.

Enter the port address of the required stream here.

Streaming

Click the checkbox to activate multicast streaming mode for the relevant stream. An enabled stream is indicated by a check mark. The device streams multicast data even if there is no active connection.

Streaming is typically not required for standard multicast operation.

Multicast packet TTL

You can enter a value to specify how long the multicast data packets are active on the network. This value must be greater than one if multicast is to be run via a router.

5.37**Advanced Mode: FTP Posting**

FTP Posting

JPEG posting

File name Overwrite

Posting interval 0 s (0 = Off)

FTP server

FTP server IP address

FTP server login

FTP server password

Path on FTP server

Max. bit rate 10000 kbps

You can save individual JPEG images on an FTP server at specific intervals. You can then retrieve these images at a later date to reconstruct alarm events if required. Furthermore, you can export selected recordings manually from the **RECORDINGS** page or activate the automatic export of alarm recordings on the **Recording Profiles** settings page.

File name

You can select how file names will be created for the individual images that are transmitted.

– **Overwrite**

The same file name is always used and any existing file will be overwritten with the current file.

- **Increment**
A number from 000 to 255 is added to the file name and automatically incremented by 1. When it reaches 255 it starts again from 000.
- **Date/time suffix**
The date and time are automatically added to the file name. When setting this parameter, ensure that the camera's date and time are always correctly set. Example: the file snap011005_114530.png was stored on October 1, 2005 at 11:45 and 30 seconds.

Posting interval

Enter the interval in seconds at which the images will be sent to an FTP server. Enter zero if you do not want any images to be sent.

FTP server IP address

Enter the IP address of the FTP server.

FTP server login

Enter your login name for the FTP server.

FTP server password

Enter the password that gives you access to the FTP server.

Path on FTP server

Enter the exact path on the FTP server.

Max. bit rate

You can limit the bit rate for FTP posting.

5.38 Advanced Mode: Encryption

A special license, with which you will receive a corresponding activation key, is required to encrypt user data. You can enter the activation key to release the function on the **Licenses** page (see Section 5.40 Advanced Mode: Licenses, page 79).

5.39 Advanced Mode: Maintenance

Maintenance			
Firmware	<input type="text"/>	<input type="button" value="Browse"/>	<input type="button" value="Upload"/>
Progress	<input type="text" value="0%"/>		
Configuration	<input type="text"/>	<input type="button" value="Browse"/>	<input type="button" value="Upload"/>
			<input type="button" value="Download"/>
SSL certificate	<input type="text"/>	<input type="button" value="Browse"/>	<input type="button" value="Upload"/>
Maintenance log			<input type="button" value="Download"/>

Firmware

The VOT-320 is designed in such a way that its functions and parameters can be updated with firmware. To do this, transfer the current firmware package to the camera via the selected network. It will then be automatically installed there.

In this way, a VOT-320 can be serviced and updated remotely without a technician having to change the installation on site.

You obtain the current firmware from your customer service or from the download area at www.boschsecurity.com.



CAUTION!

Before launching the firmware upload make sure that you have selected the correct upload file. Uploading the wrong files can result in the camera no longer being addressable, in which case you must replace the camera.

You should never interrupt the installation of firmware. An interruption can lead to the flash-EPROM being incorrectly programmed. This in turn can result in the camera no longer being addressable, in which case it will have to be replaced. Even changing to another page or closing the browser window leads to an interruption.

1. First store the firmware file on your hard drive.
2. Enter the full path of the firmware file in the field or click **Browse** to locate and select the file.
3. Next, click **Upload** to begin transferring the file to the camera. The progress bar allows you to monitor the transfer.

The new firmware is unpacked and the Flash EPROM is reprogrammed. The time remaining is shown in the message **going to reset Reconnecting in ... seconds**. The camera reboots automatically once the upload has successfully completed.

If the **CONNECT** LED then flashes red, the upload has failed and must be repeated. To perform the upload you must now switch to a special page:

1. In the address bar of your browser, enter **/main.htm** after the IP address of the VOT-320 (for example **192.168.0.10/main.htm**).
2. Repeat the upload.

Configuration

You can save configuration data for the VOT-320 on a computer and then load saved configuration data from a computer to the camera.

Upload

1. Enter the full path of the file to upload or click **Browse** to select the required file.
2. Make certain that the file to be loaded comes from the same camera type as the camera you want to configure.
3. Next, click **Upload** to begin transferring the file to the camera. The progress bar allows you to monitor the transfer.

Once the upload is complete, the new configuration is activated. The time remaining is shown in the message **going to reset Reconnecting in ... seconds**. The camera reboots automatically once the upload has successfully completed.

Download

1. Click the **Download** button. A dialog box opens.
2. Follow the on-screen instructions to save the current settings.

SSL certificate

To be able to work with an SSL encrypted data connection, both ends of a connection must hold the relevant certificates. You can upload the SSL certificate, comprising one or multiple files, onto the VOT-320.

If you wish to upload multiple files onto the VOT-320, you must select them consecutively.



NOTICE!

The certificate must be created in the format *.pem so that it can be accepted by the camera.

1. Enter the full path of the file to upload or click **Browse** to select the required file.
2. Next, click **Upload** to begin transferring the file to the camera.
3. Once all files have been successfully uploaded, the camera must be rebooted. In the address bar of your browser, enter **/reset** after the IP address of the VOT-320 (for example **192.168.0.10/reset**).

The new SSL certificate is valid.

Maintenance log

You can download an internal maintenance log from the camera to send it to Customer Service for support purposes. When doing this, ensure that **HTTPS browser port** is not set to **Off** and TLS 1.0-support is activated for your browser (see *Section HTTPS browser port, page 71*). Click **Download** and select a storage location for the file.

5.40

Advanced Mode: Licenses

Licenses	
Installation code	<input type="text" value="339226ab0300003100075f76a9751800000000000000"/> <input type="button" value="Set"/>
Activation key	<input type="text"/>
Installed licenses	<div style="border: 1px solid gray; height: 100px; width: 100%;"></div>

You can enter the activation key to release additional functions or software modules.



NOTICE!

The activation key cannot be deactivated again and is not transferable to other cameras.

5.41 Advanced Mode: System Overview

System Overview	
Hardware version	F0003242
Firmware version	02500452
Device type	VOT-320V019H
IP address	192.168.0.246
Audio option	No
Storage medium attached	Yes
Initiator name	iqn.2005-12.com.bosch:unit00075f76a975
MAC address	00-07-5F-76-A9-75
Major version number	4.52
Build number	02
Stream 1	High quality 1
Stream 2	High quality 2
Temperature	102°F / 39°C (max 113°F / 45°C)
Sensor temperature	89°F / 31.7°C
Serial number	044540600630010055
Sensor serial number	6423

The data on this page are for information purposes only and cannot be changed. Keep a record of these numbers in case technical assistance is required.

**NOTICE!**

You can select all required text on this page with the mouse and copy it to the clipboard with the [Ctrl]+[C] key combination, for example if you want to send it via e-mail.

5.42 Function test

The VOT-320 offers a variety of configuration options. You should therefore check that it is functioning correctly after installation and configuration.

The function test is the only way to ensure that the VOT-320 operates as expected in the event of an alarm.

Your check should include the following functions:

- Can the VOT-320 be called up remotely?
- Does the VOT-320 transmit all the required data?
- Does the VOT-320 respond to alarm events as required?
- Do the recordings occur as intended?
- Is it possible to control peripherals if necessary?

6 Operation

6.1 Operation with Microsoft Internet Explorer

A computer with Microsoft Internet Explorer (version 7.0 or higher) can receive live images from the VOT-320, control a pan/tilt and replay stored video sequences.

System requirements

- Computer with Windows XP or Windows Vista operating system
- Network access (Intranet or Internet)
- Microsoft Internet Explorer (version 7.0 or higher)
- Screen resolution at least 1,024 × 768 pixels
- 16- or 32-bit color depth
- Installed Sun JVM
- For playing back recordings: connection to storage medium



NOTICE!

Also note the information in the **System Requirements** document on the product CD supplied. If necessary, you can install the required programs and controls from the product CD supplied (see *Section 3.1 Parts included, page 10*).

The Web browser must be configured to enable Cookies to be set from the IP address of the camera.

In Windows Vista, deactivate protected mode on the **Security** tab under **Internet Options**.

You can find notes on using Microsoft Internet Explorer in the online Help in Internet Explorer.

Installing MPEG ActiveX

Suitable MPEG ActiveX software must be installed on the computer to allow the live video images to be played back. If necessary, you can install the program from the product CD supplied.

1. Insert the product CD into the computer's CD-ROM drive. If the CD does not start automatically, open the root directory of the CD in Windows Explorer and double-click **MPEGAx.exe**.
2. Follow the on-screen instructions.

Establishing the connection

Before you can operate the VOT-320 within your network, it must have a valid IP address for your network and a compatible subnet mask.

The following default address is preset at the factory: **192.168.0.1**

1. Start the Web browser.
2. Enter the IP address of the VOT-320 as the URL.
3. During initial installation, confirm the security questions that appear. The connection is established and after a short time you will see the **LIVEPAGE** with the video image.



6.2 The LIVEPAGE

Once the connection is established, the Web browser displays the **LIVEPAGE**. It shows the live video image on the right of the browser window. Depending on the configuration, various text overlays may be visible on the live video image (see *Section 5.12 Advanced Mode: Display Stamping, page 36*).

Other information may be shown next to the live video image on the **LIVEPAGE**. The display depends on the settings on the **LIVEPAGE Functions** page (see *Section 5.14 Advanced Mode: LIVEPAGE Functions, page 38*).

Maximum number of connections

If you do not connect, the camera may have reached its maximum number of connections. Depending on the unit and network configuration, each VOT-320 can have up to 25 Web browser connections or up to 50 connections via Bosch Video Client or Bosch Video Management System.

Protected camera

If the VOT-320 is password protected against unauthorized access, the Web browser displays a corresponding message and prompts you to enter the password when you attempt to access protected areas.



NOTICE!

A VOT-320 offers the option to limit the extent of access using various authorization levels (see *Section 5.10 Advanced Mode: Password, page 34*).

1. Enter the user name and associated password in the corresponding text fields.
2. Click **OK**. If the password is entered correctly, the Web browser displays the page that was called up.

Protected network

If a RADIUS server is employed in the network for managing access rights (802.1x authentication), the VOT-320 must be configured accordingly, otherwise no communication is possible (see *Section Authentication, page 74*).

Image selection

You can view the image of the camera in different displays.

- ▶ Click one of the tabs **Stream 1**, **Stream 2** or **M-JPEG** below the video image to toggle between the different displays of the camera image.

Display stamping

Various overlays or "stamps" in the video image provide important status information. The overlays provide the following information:



Decoding error. The frame might show artefacts due to decoding errors. If subsequent frames reference this corrupted frame, they might also show decoding errors as well but won't be marked with the "decoding error" icon.



Alarm flag set on media item



Communication error. Any kind of communication error is visualized by this icon. Cause can be a connection failure to the storage medium, a protocol violation with a sub component or simply a timeout. An automatic reconnection procedure is started in the background in order to recover from this error.

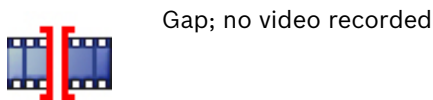

Gap; no video recorded



Watermarking not valid



Watermarking flag set on media item



Motion flag set on media item



Discovery of storage not completed. If the information about recorded video is not cached, a discovery procedure is started in order find all recorded video. During this time, the “discovery” symbol is shown. While discovery is executed, gaps might be shown in places which the discovery has not yet reached. The gap will automatically be replaced by the true video, as soon as the correct information is available.



Automatic flat-field correction (FFC) is active. During FFC, a small calibration flag (a shutter) rotates in front of the detector array, presenting a uniform temperature (a flat field) to every detector element. While imaging the flat field, the camera updates correction coefficients, resulting in a more uniform array output. The video image is frozen during the entire process, which takes less than a second, and it resumes automatically thereafter. Repeating the FFC operation often prevents the imagery from appearing “grainy”. This is especially important when the camera temperature is fluctuating, such as immediately after turn-on or when ambient temperature is drifting. The camera performs FFC whenever its temperature changes by more than 2 Kelvin or once an hour (whichever comes first). IVA is able to postpone FFC if an object is tracked to up to 1.5 hours or 3 Kelvin temperatur difference.

View Control

Control options for peripherals (for example a pan/tilt) depend on the type of unit installed and on the configuration of the VOT-320.

If a controllable unit is configured and connected to the VOT-320, the controls for the peripheral are displayed next to the video image.

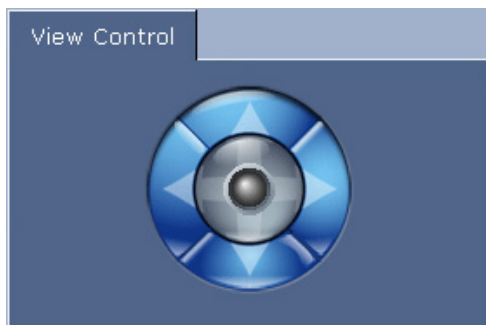

1. To control a peripheral, click the appropriate controls.
2. Move the mouse cursor over the video image. Additional options for controlling peripherals are displayed with the mouse cursor.

Digital I/O



The alarm icons **Input 1** and **Input 2** are for information purposes and indicate the status of an alarm input: When an alarm is triggered, the corresponding icon lights up blue. The camera's configuration determines whether the alarm is displayed, as well as additional details (see *Section 5.14 Advanced Mode: LIVEPAGE Functions, page 38*).

Triggering relay

You can switch connected units using the relays in the VOT-320 (for example lights or door openers).

- ▶ To activate this, click the icon for the corresponding relay next to the video image. The icon will be red when the relay is activated.

System Log / Event Log

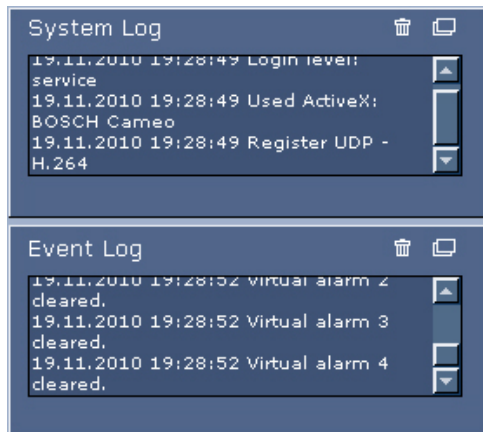

The **System Log** field contains information about the operating status of the VOT-320 and the connection. You can save these messages automatically in a file (see *Section 5.14 Advanced Mode: LIVEPAGE Functions, page 38*).

Events such as the triggering or end of alarms are shown in the **Event Log** field. You can save these messages automatically in a file (see *Section 5.14 Advanced Mode: LIVEPAGE Functions, page 38*).

1. If you want to delete the entries, click the delete icon in the top right-hand corner of the relevant field.
2. If you want to view a detailed log, click the icon in the top right-hand corner of the relevant field. A new window will open.

6.3 Saving snapshots

You can save individual images from the video sequence currently shown on the **LIVEPAGE** in JPEG format on your computer's hard drive. The icon for recording single images is only visible if the camera is configured to enable this process (see *Section Allow snapshots, page 39*).

- ▶ Click the icon. The image is saved at a resolution of 320 × 240 pixels (QVGA). The storage location depends on the configuration of the VOT-320 (see *Section Path for JPEG and video files, page 39*).



6.4 Recording video sequences

You can save sections of the video sequence currently shown on the **LIVEPAGE** on your computer's hard drive. The icon for recording video sequences is only visible if the camera is configured to enable this process (see *Section Allow local recording, page 39*).

1. Click the icon to start recording. The storage location depends on the configuration of the VOT-320 (see *Section Path for JPEG and video files, page 39*). A red dot in the icon indicates that recording is in progress.



2. Click the icon again to stop recording.

Image resolution

Sequences are saved at a resolution of 320 × 240 pixels (QVGA).

6.5 Running recording program

The hard drive icon below the camera image on the **LIVEPAGE** changes during an automatic recording.



A moving graphic will appear to indicate a running recording. If no recording is taking place, a static icon is displayed.

6.6 The RECORDINGS page

The **RECORDINGS** page for playing back recorded video sequences can be accessed from the **LIVEPAGE** and from the **SETTINGS** menu.

The **RECORDINGS** link is only visible if a storage medium has been selected (see *Section 5.19 Advanced Mode: Storage Management, page 45*).

- ▶ Click the **RECORDINGS** link in the navigation bar in the upper section of the window. The playback page appears.



Selecting recordings

All recordings that are saved are displayed in the list. A running number (track) is assigned to each recording. Start time and stop time, recording duration, number of alarms, and recording type are displayed.

1. Select **1** or **2** from the **Recording** list. (The contents for 1 and 2 are identical, only the quality and location may be different.)
2. Use the arrow buttons below the list to browse the list.
3. Select the number of entries that are displayed simultaneously.
4. Click a list entry. The playback for the selected track starts immediately in the video window.

Exporting recordings

You can export tracks or sequences to an FTP server. The FTP server is defined on the **FTP Posting** settings page.

1. In the list, select the tracks you want to export.
2. If required, change the times within the selected range. To do so, drag the mouse over the time bar or enter the values in the text fields next to the **Export to FTP** button.
3. Click **Export to FTP** to send the selected recordings to the FTP server. The information below the button allows you to monitor the export.

Controlling a playback

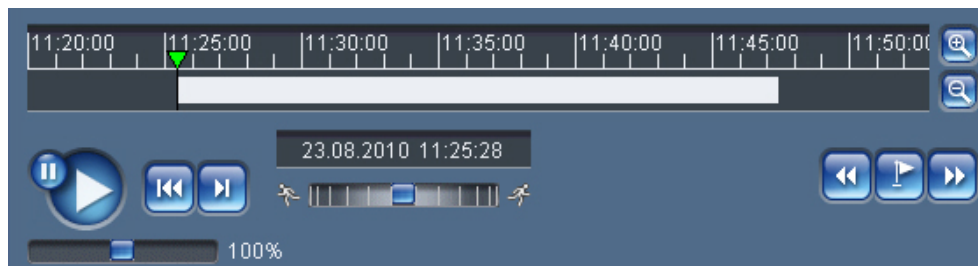

You will see a time bar below the video image for quick orientation. A green arrow above the bar indicates the position of the image currently being played back within the sequence.

The time bar offers various options for navigation.

Red bars indicate the points in time where alarms were triggered. Drag the green arrow to navigate to these points quickly.

1. You can change the time interval by clicking the zoom keys (magnifying glass icons). The display can span a range from two months to a few seconds.
2. Drag the green arrow to the point in time at which playback should begin. The date and time display below the bar provides orientation to the second.

Buttons

You can control playback by means of the buttons below the video image. The buttons have the following functions:



Start or pause playback



Leap to the start of the active video sequence or to the previous sequence



Leap to the start of the next video sequence

Slide controls

Use the slide control below the Start button to control playback speed. The default value of 100% represents real time speed. Higher values speed up the playback, lower values slow it down.

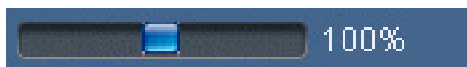

Use the slide control below the time bar to control playback direction. Drag the rectangle to the right for fast forwarding the playback. Drag it to the left for rewinding.



Bookmarks

In addition, you can set markers in the sequences, so-called bookmarks, and leap directly to these. These bookmarks are indicated as small yellow arrows above the time interval. Use the bookmarks as follows:



Jump to the previous bookmark



Set bookmark



Jump to the following bookmark



NOTICE!

Bookmarks are only valid while you are in the **RECORDINGS** page; they are not saved with the sequences. As soon as you leave the page all bookmarks are deleted.

6.7

Hardware connections between video servers

A VOT-320 can be used as a sender and a compatible hardware decoder (such as the VIP XD) with a connected monitor as a receiver using an Ethernet network connection. In this way it is possible to cover long distances without the need for major installation or cabling work.



NOTICE!

The sender and receiver must be located in the same subnet to establish a hardware connection.

Installation

Compatible video servers are designed to connect to one another automatically, provided they are correctly configured. They only need to be part of a closed network. Proceed as follows to install the units:

1. Connect the units to the closed network using Ethernet cables.
2. Connect them to the power supply.



NOTICE!

Make sure that the units are configured for the network environment and that the correct IP address for the remote location to be contacted in the event of an alarm is set on the **Alarm Connections** configuration page (see *Section 5.24 Advanced Mode: Alarm Connections, page 53*).

Connecting

There are three options for establishing a connection between a sender and a compatible receiver in a closed network:

- an alarm,
- a terminal program, or
- Internet Explorer.

**NOTICE!**

Connecting with a Web browser is described in the manual of the relevant unit that is to be used as the receiver, for example VIP XD.

Connecting on alarm

With the appropriate configuration, a connection between a sender and a receiver is made automatically when an alarm is triggered (see *Section 5.24 Advanced Mode: Alarm Connections, page 53*). After a short time the live video image from the sender appears on the connected monitor.

This option can also be used to connect a sender and a compatible receiver using a switch connected to the alarm input. You do not need a computer to make the connection in this case.

Connecting with a terminal program

Various requirements must be met in order to operate with a terminal program (see *Section 8.9 Communication with terminal program, page 101*).

1. Start the terminal program and enter the command **4** in the main menu to switch to the **Rcp+** menu.
2. Enter the command **c** in the **Rcp+** menu to change the remote IP address, then enter the IP address of the unit you wish to connect to.
3. In the **Rcp+** menu, enter command **1** to activate automatic connection.

Closing the connection with a terminal program

1. Start the terminal program and enter the command **4** in the main menu to switch to the **Rcp+** menu.
2. In the **Rcp+** menu, enter command **3** to deactivate automatic connection.

6.8 Operation using software decoders

The camera VOT-320 provides a highly efficient systems solution together with the Bosch Video Client software.

Bosch Video Client is a software package for operating, controlling and managing CCTV installations (such as surveillance systems) at remote locations. It runs under Microsoft Windows operating systems. It is primarily designed for decoding video, audio and control data received from a remote sender.

There are many options available for operation and configuration when using a VOT-320 with Bosch Video Client. Please refer to the software documentation for more details.

Another program that supports the VOT-320 is Bosch Video Management System.

Bosch Video Management System is an IP video security solution that enables the seamless management of digital video, audio and data over any IP network. It was developed for use with Bosch CCTV products as one component of an extensive video security management system. It allows you to integrate your existing components into a simple-to-control system or into the entire Bosch range, benefiting from a complete security solution based on the latest technology and years of experience.

The camera VOT-320 is also designed for use with the DiBos 8 digital recorder.

DiBos 8 records up to 32 video and audio streams and is available as IP software or hybrid DVR with additional analog camera and audio inputs. DiBos supports the most diverse functions on the VOT-320, for example relay activation, remote control of peripherals and remote configuration. DiBos 8 can use the alarm inputs for event triggering and, on release of the MOTION+ motion detector, record the activated cells to enable intelligent motion search.

7 Maintenance and upgrades

7.1 Testing the network connection

You can use the **ping** command to check the connection between two IP addresses. This allows you to test whether a unit in the network is active.

1. Open the DOS command prompt.
2. Type **ping** followed by the IP address of the camera.

If the camera is found, the response appears as **Reply from ...** followed by the number of bytes sent and the transmission time in milliseconds. If not, the camera cannot be accessed over the network. This might be because:

- The camera is not correctly connected to the network. Check the cable connections in this case.
- The camera is not correctly integrated into the network. Check the IP address, subnet mask and gateway address.

7.2 Camera reset

You can use the Factory Reset button to restore the camera to its original settings. Any changes to the settings are overwritten by the factory defaults. A reset may be necessary, for example, if the camera has invalid settings that prevent it from functioning as desired.



CAUTION!

Disconnect the power supply from the mains before opening the housing of the camera. All configured settings will be discarded during a reset.

If necessary, back up the current configuration using the **Download** button on the **Maintenance** configuration page (see *Section 5.39 Advanced Mode: Maintenance, page 77*).



NOTICE!

After a reset, the camera can only be addressed via the factory default IP address. The IP address can be changed as described in the **Installation** chapter (see *Section 4.7 Setup using Bosch Video Client, page 22*).

1. If necessary, back up the current configuration using the **Download** button on the **Maintenance** configuration page (see *Section 5.39 Advanced Mode: Maintenance, page 77*).
2. Open the cover of the housing, press the Factory Reset button located on the camera module beside the SD slot until the **CONNECT** LED flashes red (see *Section 3.4 Controls and displays on the camera module, page 15*). All settings will revert to their defaults.
3. Change the IP address of the VOT-320 if necessary.
4. Configure the camera to meet your requirements.

7.3 Fuse replacement

There is a spare fuse inside the housing.



CAUTION!

Disconnect the power supply from the mains before opening the housing of the camera.

1. Open the cover of the housing.
2. Open the F501 fuse holder (opening **E** on camera module) by means of a screwdriver (see *Section 3.4 Controls and displays on the camera module, page 15*).
3. Replace the fuse with a 5 × 20 mm fuse that has the same current rating: medium, 250 V, 3.15 A. The following fuses may be used:
 - Littelfuse 0218 3.15 MXP or
 - COOPER Bussmann S506-3.15A-R

7.4 Repairs



CAUTION!

Never open the camera module of the VOT-320.
The camera module does not contain any user-serviceable parts.

Ensure that all maintenance or repair work is carried out only by qualified personnel (electrical engineers or network technology specialists). In case of doubt, contact your dealer's technical service center.

7.5 Transfer and disposal

The VOT-320 should only be passed on together with this installation and operating manual. Your Bosch product is designed and manufactured with high-quality materials and components which can be recycled and reused.



This symbol means that electrical and electronic equipment, at their end-of-life, should be disposed of separately from your household waste.

In the European Union, there are separate collection systems for used electrical and electronic products. Please dispose of this equipment at your local community waste collection/recycling center.

7.6 Export limitations

The camera model VOT-320-V xxH with 30 ips frame rate is governed by the United States Export Administration Regulations. When re-selling the VOT-320 the seller is responsible for applying for the required licenses. He commits himself to compliance with applicable export control regulations. The seller is specifically advised to check the applicability of the US re-export control legislation.

8 Appendix

8.1 Troubleshooting

If you are unable to resolve a malfunction, please contact your supplier or systems integrator, or go directly to Bosch Security Systems Customer Service.

You can view a range of information about your unit version on the **System Overview** page (see *Section 5.41 Advanced Mode: System Overview, page 80*). Make a note of this information before contacting Customer Service. You can download an internal maintenance log from the unit on the **Maintenance** page if you wish to send it to Customer Service by e-mail (see *Section Maintenance log, page 79*).

The following tables are intended to help you identify the causes of malfunctions and correct them where possible.

8.2 General malfunctions

Malfunction	Possible causes	Recommended solution
No connection between the camera and terminal program.	Incorrect cable connections.	Check all cables, plugs, contacts, terminals and connections.
	The computer's serial interface is not connected.	Check the other serial interface.
	Interface parameters do not match.	If necessary select a different interface and make sure that the computer's interface parameters match those of the unit. Try the following standard parameters: 19,200 baud, 8 data bits, no parity, 1 stop bit. Next, disconnect the unit from the power supply and reconnect it again after a few seconds.
No image transmission to remote station.	Camera error.	Connect local monitor to the camera and check the camera function.
	Faulty cable connections.	Check all cables, plugs, contacts and connections.
	Incorrect encoder stream property set for connection to hardware decoder.	Select the H.264 BP+ (HW decoder) option on the Encoder Streams configuration page.

Malfunction	Possible causes	Recommended solution
No connection established, no image transmission.	The unit's configuration.	Check all configuration parameters.
	Faulty installation.	Check all cables, plugs, contacts and connections.
	Wrong IP address.	Check the IP addresses (terminal program).
	Faulty data transmission within the LAN.	Check the data transmission with ping .
	The maximum number of connections has been reached.	Wait until there is a free connection and then call the sender again.
The camera does not report an alarm.	Alarm source is not selected.	Select possible alarm sources on the Alarm Inputs configuration page.
	No alarm response specified.	Specify the desired alarm response on the Alarm Connections configuration page, change the IP address if necessary.
Control of pan/tilt or other units is not possible.	The cable connection between the serial interface and the connected unit is not correct.	Check all cable connections and ensure all plugs are properly fitted.
	The interface parameters do not match those of the other unit connected.	Make sure that the settings of all units involved are compatible.
The camera is not operational after a firmware upload.	Power failure during programming by firmware file.	Have the unit checked by Customer Service and replace if necessary.
	Incorrect firmware file.	Enter the IP address of the unit followed by /main.htm in your Web browser and repeat the upload.
Placeholder with a red cross instead of the ActiveX components.	JVM not installed on your computer or not activated.	Install Sun JVM from the product CD.
Web browser contains empty fields.	Active proxy server in network.	Create a rule in the local computer's proxy settings to exclude local IP addresses.
The CONNECT LED flashes red.	Firmware upload failed.	Repeat firmware upload.

8.3 Malfunctions with iSCSI connections

Malfunction	Possible causes	Recommended solution
After connecting to the iSCSI target, no LUNs are displayed.	Incorrect LUN mapping during iSCSI system configuration.	Check the iSCSI system configuration and reconnect.
After connecting to the iSCSI target, "LUN FAIL" appears below a node.	The LUN list could not be read, as it was assigned to the wrong network interface.	Check the iSCSI system configuration and reconnect.
LUN mapping is not possible.	Some iSCSI systems do not support the use of an initiator extension.	Delete the initiator extension on the Identification configuration page.

8.4 LEDs

The VOT-320 has LEDs on its camera module that show the operating status and can give indications of possible malfunctions (see *Section 3.4 Controls and displays on the camera module, page 15*):

CONNECT (opening A)

Does not light up:	VOT-320 is switched off.
Lights up green:	VOT-320 is running.
Lights up red:	Startup in progress.
Flashes green:	Video transmission.
Flashes red:	Firmware upload failed.

LINK and ACT (opening B)

Green LED lights up:	Link: Network connection established.
Orange LED lights up:	Activity: Data transmission via network connection.

LED group D (opening D)

UP (red):	Pan/tilt is moving up.
LEFT (red):	Pan/tilt is moving left.
RIGHT (red):	Pan/tilt is moving right.
DOWN (red):	Pan/tilt is moving down.
WND (red):	Window heater is switched on.
HTR (red):	Printed circuit board heating is switched on.
PWR (orange):	VOT-320 is switched on.

8.5 Processor load

If the VOT-320 is accessed via the Web browser, you will see the processor load indicator in the top left of the window next to the manufacturer's logo.

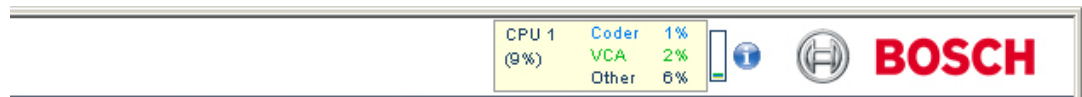

You can obtain additional information to help you when troubleshooting or fine tuning the unit. The values indicate the proportions of the individual functions on the encoder load, shown as percentages.

- Move the cursor over the graphic indicator. Some additional numerical values are also displayed.

8.6 Network connection

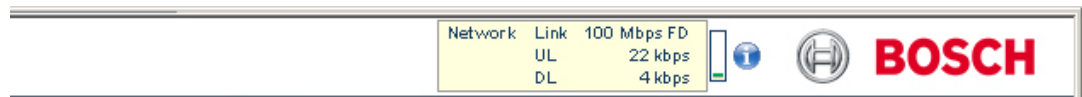

You can display information about the network connection. To do this, move the cursor over the **i** icon.

Link	Ethernet link type
UL	Uplink, speed of the outgoing data traffic
DL	Downlink, speed of the incoming data traffic

8.7 Serial interface

Options for using the serial interface include transferring transparent data, controlling connected units or operating the unit with a terminal program.

The serial interface supports the RS-232, RS-422 and RS-485 transmission standards. The mode used depends on the current configuration (see *Section 5.33 Advanced Mode: COM1, page 68*). Connection is via the upper 6-pin terminal block.

8.8 Terminal blocks

The VOT-320 offers three pairs of terminal blocks arranged in an upper (U) and lower (L) row:

- X-block: 2-pin blocks for power supply and window defroster
- Y-block: 5-pin blocks for PT control
- Z-block: 6-pin blocks for serial data transmission, relay outputs and alarm inputs

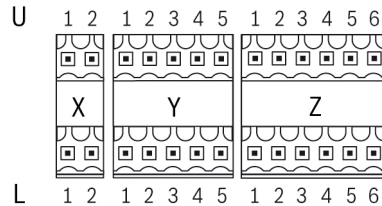

Power supply (upper 2-pin terminal block)

Connect the power supply to the upper 2-pin terminal block (UX1 and UX2).

Window defroster (lower 2-pin terminal block)

The window defroster by default is connected to the lower 2-pin terminal block (LX1 and LX2)

PT control (upper and lower 5-pin terminal blocks)

Pan/tilts are connected to the Y-block as follows:

Row	Pin No.	Contact	Function
U	1	Pan Right	Panning to the right
U	2	Pan Left	Panning to the left
U	3	P/T Common	Return path for P/T motors
U	4	Pan Position	Analog feedback on position
U	5	Tilt Position	Analog feedback on position
L	1	Tilt Up	Tilting up
L	2	Tilt Down	Tilting down
L	3	P/T Common	Return path for P/T motors
L	4	PP Return (-)	Supply for analog feedback of position
L	5	PP Supply (+)	Supply for analog feedback of position

Bosch LTC 9418/11 and LTC 9418/21 are recommended as pan/tilts. For additional information and wiring diagrams refer to the corresponding manuals.



CAUTION!

Please take note of the appropriate documentation when installing and operating the unit to be controlled.

The documentation contains important safety instructions and information about permitted uses.

Serial interface (upper 6-pin terminal block)

The pin assignment of the serial interface depends on the interface mode used (see *Section 5.33 Advanced Mode: COM1, page 68*).

Pin No.	Contact	RS-232 mode	RS-422 mode	RS-485 mode
1	RXD	RxD (receive data)	RxD+ (receive data plus)	Data+
2	CTS	CTS (clear to send)	RxD- (receive data minus)	Data-
3	RTS	RTS	TxD+ (transmit data plus)	Data+
4	TXD	TxD (transmit data)	TxD- (transmit data minus)	Data-
5	GND	GND (ground)	–	–
6	GND	–	–	–

Relay and alarm (lower 6-pin terminal block)

Pin No.	Contact	Function
1	R1	Relay output 1
2	R1	Relay output 1
3	R2	Relay output 2
4	R2	Relay output 2
5	IN1	Input alarm 1
6	IN2	Input alarm 2

Connect each alarm input to a ground contact (GND) on the upper 6-pin terminal block when connecting alarm inputs.

8.9 Communication with terminal program

Data terminal

If a VOT-320 cannot be found in the network or the connection to the network is interrupted, you can connect a data terminal to the VOT-320 for initial setup and setting of important parameters. The data terminal consists of a computer with a terminal program.

You require a serial transmission cable with a 9-pin Sub-D plug to connect to the computer and open ends for connection to the terminal block of the VOT-320 (see *Section Relay and alarm (lower 6-pin terminal block)*, page 100).

HyperTerminal, a communications accessory included with Microsoft Windows, can be used as the terminal program.



NOTICE!

Information on installing and using HyperTerminal can be found in the manuals or in the online help for Microsoft Windows.

1. Disconnect the VOT-320 from the Ethernet network before working with the terminal program.
2. Connect the serial interface of the VOT-320 using any available serial interface on the computer.

Configuring the terminal

Before the terminal program can communicate with the VOT-320, the transmission parameters must be matched. Make the following settings for the terminal program:

- 19,200 bps
- 8 data bits
- No parity check
- 1 stop bit
- No protocol

Command inputs

After the connection has been established, you must log on to the VOT-320 to access the main menu. Other submenus and functions can be accessed using the on-screen commands.

1. If necessary, turn off the local echo so that entered values are not repeated on the display.
2. Enter one command at a time.
3. When you have entered a value, such as the IP address, check the characters you have entered before pressing Enter to transfer the values to the VOT-320.

Assigning an IP address

Before you can operate a VOT-320 in your network you must first assign it an IP address that is valid for your network.

The following default address is preset at the factory: **192.168.0.1**

1. Start a terminal program such as HyperTerminal.
2. Enter the user name **service**. The terminal program displays the main menu.
3. Enter command **1** to open the **IP** menu.

```

-----
| VOT-320V IVA
-----
' 0' Exit menu IP      (* = reset after change necessary)
' 1' local IP         (*) 192.168.0.1
' 2' local subnet mask (*) 255.255.255.0
' 3' local gateway   (*) 0.0.0.0
' 4' dns server IP   0.0.0.0
' 5' ntp server
' 6' ntp mode         1 (SNTP)
' 7' DHCP enabled    (*) NO
' 8' igmp version    (*) Auto
' 9' alarm IP ...
' a' discover ...
' b' iscsi ...
' c' http port       80
' d' https port      443
' e' snmp port       (*) 161
' f' more...
-----

```

4. Enter **1** again. The terminal program displays the current IP address and prompts you to enter a new IP address.
5. Enter the desired IP address and press Enter. The terminal program displays the new IP address.
6. Use the displayed commands for any additional settings you require.



NOTICE!

You must reboot to activate the new IP address, a new subnet mask or a gateway IP address.

Reboot

Briefly interrupt the power supply to the VOT-320 for a reboot (disconnect the power supply unit from the mains supply and switch on again after a few seconds).

Additional parameters

You can use the terminal program to check other basic parameters and modify them where necessary. Use the on-screen commands in the various submenus to do this.

8.10 Copyrights

The firmware 4.5 uses the fonts "Adobe-Helvetica-Bold-R-Normal--24-240-75-75-P-138-ISO10646-1" and "Adobe-Helvetica-Bold-R-Normal--12-120-75-75-P-70-ISO10646-1" under the following copyright:

Copyright 1984-1989, 1994 Adobe Systems Incorporated.

Copyright 1988, 1994 Digital Equipment Corporation.

Permission to use, copy, modify, distribute and sell this software and its documentation for any purpose and without fee is hereby granted, provided that the above copyright notices appear in all copies and that both those copyright notices and this permission notice appear in supporting documentation, and that the names of Adobe Systems and Digital Equipment Corporation not be used in advertising or publicity pertaining to distribution of the software without specific, written prior permission.

This software is based in part on the work of the Independent JPEG Group.

9 Specifications

9.1 Camera

Operating voltage	24 V AC (SELV) $\pm 10\%$ 50/60 Hz power supply via external unit
Power consumption	1.4 A (24 V AC) max. with all heaters on 3.1 A (24 V AC) max. with all heaters on and pan/tilt at full load
LAN interfaces	1 \times Ethernet 10/100 Base-T, automatic adjustment, half/full duplex, RJ45
Data interfaces	1 \times RS-232/RS-422/RS-485, bidirectional, push-in terminal
Local storage	1 \times SD card slot, for standard SD or SDHC cards up to 32 GB
Pan/tilt	1 \times push-in terminal for direct connection of pan/tilts
Alarm inputs	2 \times push-in terminals (non-isolated closing contact), maximum activation resistance 10 Ohm
Relay outputs	2 \times push-in terminals, 30 V _{p-p} (SELV), 200 mA, 4 contacts
Video output	1 \times BNC socket 0.7 to 1.2 V _{p-p} , 75 Ohm, NTSC
Displays	10 \times LED on the camera board (power, video transmission, pan/tilt control, heater, network connection, data transfer)
Operating conditions	Temperature: -50 to $+55$ °C / -58 to $+131$ °F Relative humidity: 20 to 93%, non-condensing
Storage conditions	Temperature: -55 to $+70$ °C / -67 to $+158$ °F Relative humidity: 0 to 98%, non-condensing
Enclosure protection	IP66, NEMA Type 4
Approvals	AS/NZS CISPR22, EN 50130-4, EN 55022 Class B, EN 55024, EN 61000-3-2, EN 61000-3-3, EN 61000-4-5, EN 50130-4/13, EN 50121-4, FCC 47 CRF Part 15 Subpart B Class B, EMC directive 2004/108/EC, VCCI Class B, EN 60068-2-5 SA, IEC 60950-1, IEC 60529
Dimensions (H \times W \times L)	171.3 \times 171.3 \times 480 mm / 6.7 \times 6.7 \times 18.9 in
Weight	Approx. 3.5 kg / 7.7 lb

9.2 Detector

Type	Focal plane array, uncooled Vanadium Oxide (VOx) Microbolometer
Active pixels	320 \times 240
Spectral range	7.5 to 13.5
Thermal sensitivity	<60 mkat f/1.0
Scene range	-40 to $+160$ °C

9.3 Protocols/standards

Video standards	NTSC
Video coding protocols	H.264 MP (Main Profile), H.264 BP+, M-JPEG, JPEG
Video data rate	9.6 kbps to 6 Mbps
Image resolution (h × v)	320 × 240 pixels (QVGA)
Total delay	240 ms max. (H.264 MP, GOP IP) 400 ms max. (H.264 BP+, GOP IP)
Image refresh rate	8.33 ips max. (VOT-320-V xxL) 30 ips max. (VOT-320-V xxH; subject to export limitations - UTIC-list)
Network protocols	RTP, Telnet, UDP, TCP, IP, HTTP, HTTPS, FTP, DHCP, IGMP V2, IGMP V3, ICMP, ARP, SMTP, SNTP, SNMP, RTSP, 802.1x, iSCSI, DynDNS, UPnP

Glossary

0...9

10/100/1000 Base-T IEEE-802.3 specification for 10, 100 or 1000 Mbps Ethernet

802.1x The IEEE 802.1x standard provides a general method for authentication and authorization in IEEE-802 networks. Authentication is carried out via the authenticator, which checks the transmitted authentication information using an authentication server (see RADIUS server) and approves or denies access to the offered services (LAN, VLAN or WLAN) accordingly.

A

ARP Address Resolution Protocol: a protocol for mapping MAC and IP addresses

B

Baud Unit of measure for the speed of data transmission

bps Bits per second, the actual data rate

BVIP Bosch Video over IP unit

C

CF CompactFlash; interface standard, for digital storage media amongst other things. Used in computers in the form of CF cards, digital cameras and Personal Digital Assistants (PDA).

CIF Common Intermediate Format, video format with 352 × 288/240 pixels

D

DHCP Dynamic Host Configuration Protocol: uses an appropriate server to enable dynamic assignment of an IP address and other configuration parameters to computers on a network (Internet or LAN)

DNS Domain Name System, mainly used for converting domain names to IP addresses

DynDNS DNS hosting service that works according to RFC 2845 and stores the IP addresses of its clients in a database, ready for use

F

FFC Flat-field correction; internal mechanism in thermal IP camera VOT-320 for periodically improving image quality.

FOV Field Of View, area covered by the picture angle of an optical device

FTP File Transfer Protocol

Full duplex Simultaneous data transmission in both directions (sending and receiving)

G

GBIC	GigaBit Interface Converter; applied in network technology to render interfaces flexible, for converting an electrical interface into an optical interface, for example. This enables flexible operation of an interface as a Gigabit Ethernet via twisted-pair cables or fiber optic cables.
GOP	Group of Pictures; group of consecutive frames in a video stream of images. A GOP always begins with an I-frame, followed by one or more P-frames. B-frames and R-frames can also be included.

H

H.264	Standard for high-efficiency video compression, based on the predecessors MPEG-1, MPEG-2 and MPEG-4. H.264 typically achieves a coding efficiency around three times as high as MPEG-2. This means that comparable quality can be achieved at around a third of MPEG-2 data quantity.
HTTP	Hypertext Transfer Protocol: protocol for transmitting data over a network
HTTPS	Hypertext Transfer Protocol Secure: encrypts and authenticates communication between Web server and browser

I

I-frame	GOP image type intra-coded picture; reference picture that corresponds to a still image and is independent of other types of images. Each GOP begins with this image type.
ICMP	Internet Control Message Protocol
ID	Identification: a machine readable character string
IEEE	Institute of Electrical and Electronics Engineers
IGMP	Internet Group Management Protocol
Internet Protocol	The main protocol used on the Internet, normally in conjunction with the Transfer Control Protocol (TCP): TCP/IP
IP	See Internet Protocol
IP address	A 4-byte number uniquely defining each unit on the Internet. It is usually written in dotted decimal notation, for example "209.130.2.193"
iSCSI	Storage over IP process for storage networks; specifies how storage protocols are operated over IP
ISDN	Integrated Services Digital Network

J

JPEG	An encoding process for still images (Joint Photographic Experts Group)
------	---

K

kbps	Kilobits per second, the actual data rate
------	---

L

LAN	See Local Area Network
Local Area Network	A communications network serving users within a limited geographical area such as a building or university campus. It is controlled by a network operating system and uses a transfer protocol.
LUN	Logical Unit Number; logical drive in iSCSI storage systems

M

MAC	Media Access Control
MIB	Management Information Base; a collection of information for remote servicing using the SNMP protocol
MPEG-2	Improved video/audio compression standard, compression on highest level allows images in studio quality; now established as broadcast standard
MPEG-4	A further development of MPEG-2 designed for transmitting audiovisual data at very low transfer rates (for example over the Internet)
MSS	Maximum Segment Size; maximum byte figure for the user data in a data packet

N

Net mask	A mask that explains which part of an IP address is the network address and which part is the host address. It is usually written in dotted decimal notation, for example "255.255.255.192."
NFOV	Narrow Field Of View, <i>see</i> FOV
NTP	Network Time Protocol; a standard for synchronizing computer system clocks via packet-based communication networks. NTP uses the connectionless network protocol UDP. This was developed specifically for enabling time to be reliably transmitted over networks with variable packet runtime (Ping).

O

OF	Optical Fiber; now used predominantly as the transmission medium for line-borne telecommunication processes (glass fiber cable)
----	---

P

P-frame	GOP image type predictive-coded picture; contains difference information from the preceding I- or P-frame
Parameters	Values used for configuration

Q

QCIF	Quarter CIF, video format with 176 × 144/120 pixels
QP	Quantization Parameter; specifies the degree of compression in the H.264 protocol and thus the image quality for each stream. The lower the QP value, the higher the encoding quality.
QVGA	Quarter Video Graphics Array, video format with 320 × 240 pixels

R

RADIUS server	Remote Authentication Dial-In User Service: a client/server protocol for the authentication, authorization and accounting of users with dial-up connections on a computer network. RADIUS is the de-facto standard for central authentication of dial-up connections via Modem, ISDN, VPN, Wireless LAN (see 802.1x) and DSL.
RFC 868	A protocol for synchronizing computer clocks over the Internet
RS-232/-422/-485	Standards for serial data transmission
RTP	Real-Time Transport Protocol; a transmission protocol for real-time video and audio
RTSP	Real-Time Streaming Protocol; network protocol for controlling the continuous transmission of audiovisual data (streams) or software over IP-based networks

S

SD card	Secure Digital Memory Card; digital memory card that works on the flash principle
SFP	Small Form-factor Pluggable; small, standardized module for network connections, designed as a plug connector for high-speed network connections
SNIA	Storage Networking Industry Association; association of companies for defining the iSCSI standard
SNMP	Simple Network Management Protocol; a protocol for network management, for managing and monitoring network components
SNTP	Simple Network Time Protocol; a simplified version of NTP (see NTP)
SSL	Secure Sockets Layer; an encryption protocol for data transmission in IP-based networks
Subnet mask	See Net mask

T

TCP	Transmission Control Protocol
Telnet	Login protocol with which users can access a remote computer (Host) on the Internet
TLS	Transport Layer Security; TLS 1.0 and 1.1 are the standard advanced developments of SSL 3.0 (see SSL)
TTL	Time-To-Live; life cycle of a data packet in station transfers

U

UDP	User Datagram Protocol
UPnP	Universal Plug and Play; the protocol used for device actuation over an IP network regardless of the manufacturer. As soon as a UPnP device has an IP address, it must report its existence in the network to the control points via UDP. Similarly, control points can search the network for UPnP devices and make them accessible.
URL	Uniform Resource Locator
UTP	Unshielded Twisted Pair

W

WAN *See* Wide Area Network

WFOV Wide Field Of View, *see* FOV

Wide Area Network A long distance link used to extend or connect remotely located local area networks

Index

A

Activating the recording 52
Activation key 79
Advanced Mode 26
Alarm 16, 37, 86
Alarm e-mail 63
Alarm input 20
Alarm inputs 66
Alarm message 37
Alarm script 62
Alarm sensors 50
Auto-connect 55

B

Basic Mode 26
Baud rate 68
Bookmarks 90
Browser window 84

C

Camera name 28, 33
Camera selection 84
Card slot 15
Changes 27
Changes in light level 59
Checking network 93
Closing contact 20
COM1 68
Configuration 24, 78
Configuration download 78
Configuration mode 26
Connect on alarm 54
Connecting 24, 90
Control 68
Control functions 85
Controlling a Playback 88
Conventions 6

D

Danger 8
Data bits 68
Data interface 19
Data terminal 101
Date 35
Date format 35
Daylight saving time 35
Default 42, 48, 56, 57
Default profile 42
Deleting recordings 47
Device ID 33
DHCP server 30
Display stamping 36, 84
Dual Streaming 43
DynDNS 71

E

Echo 101
Electromagnetic compatibility 7
E-mail 63
Encoder load 98
Encoding 12
Encryption protocol 71

EPROM 78
Establishing the connection 25, 83
Ethernet connection 16
Event log 39, 86
Export 94

F

Factory settings 15
False alarms 59
FFC 85
Firewall 54, 70
Firmware upload 77
Format 47
FTP server 76, 77
Function test 81
Fuse 15

G

Gateway 30, 70
General password 54

H

Holidays 52, 61
HTTP port 70
HTTPS port 71

I

Identification 7
IEEE 802.1x 74
IGMP 75
Image quality 76
Image resolution 87
Image selection 84
Initiator name 33
Installation 8
Installation conditions 17
Interface 98
Interface mode 68
Internal clock 35
IP address 30, 70, 102
iSCSI settings 46

J

JPEG posting 76
JPEG posting interval 77

L

Language 37
Licenses 79
Live video images 24, 82
Livepage 38
Low Voltage Directive 7

M

Main functions 14
Maintenance 9
Manufacturer logo 37
Media-replay 88
Milliseconds 37
Motion detector 56
Motion detector defaults 56, 57
Motion detector object size 59
Motion detector sensitivity 59
MPEG ActiveX 24, 82
MTU value 70, 71

Multicast address 75
 Multicast connection 70, 75
 Multicast function 12
 Multicasting 75
 Multi-unicast 75
N
 Name
 Camera 28, 33
 User 28, 34
 Navigation 27
 Network 19, 30, 69, 73
 Network connection 21, 98
 Number of connections 25, 84

O
 Operation 8, 82
 Overview of functions 12

P
 Pan/tilt 15
 Parameters 23, 102
 Parity check 68
 Parts included 10
 Password 26, 28, 34, 84
 Peripheral device control 85
 Picture settings 40
 Pin assignment 100
 Playback button 89
 Port 70, 76
 Post-alarm time 49
 Power off 21
 Power on 21
 Power supply 8, 16, 21
 Power switch 21
 Pre-alarm time 49
 Processor load 98
 Processor load indicator 98
 Product name 37
 Profile configuration 40
 Profiles 31, 41
 Protocol 68

R
 RADIUS 74
 Reboot 102
 Receiver 12
 Receiver password 54
 Recording media 46
 Recording profiles 48
 Recording program 87
 Recording scheduler 51
 Recording status 52
 Recording video sequences 87
 Reflections of light 59
 Regulations 6
 Relay 16, 20
 Relay output 66
 Relay outputs 20
 Remote control 13
 Repair 9, 94
 Replay 88
 Reset 15, 93
 Router 76

S
 Safety 8
 Saving event log 39
 Saving system log 39
 Screen resolution 11, 24, 82
 Select area 59
 Sensor fields 59
 Serial interface 16
 Serial number 7
 Serial port function 68
 Signal source 20
 SMS 64
 Snapshots 13, 87
 SNMP 73
 SNTP server 29, 36
 Software decoder 92
 SSL certificate 79
 SSL encryption 55
 Standard recording profile values 48
 Stop bits 68
 Storage media 46
 Storage medium 32, 45
 Streaming 76
 Subnet mask 30, 70
 Summer time 35
 Symbols 6
 Synchronize 29, 35
 System log 39, 40, 86
 System requirements 11, 24, 82

T
 Tamper switch 15
 Target bit rate 41
 TCP 54, 70
 Terminal 68
 Test 81
 Time 29, 35, 36
 Time server 29, 36
 Time server IP address 29, 36
 Time server protocol 29, 36
 Time signal 29, 36
 Time zone 35
 TLS 71
 Transmission parameters 101
 Transmission protocol 54, 70
 Transmission rate 68
 Transmission standards 19, 98
 Transparent 68
 Traps 74
 Trigger 20
 Triggering relay 67
 Tri-streaming 12
 TTL 76

U
 UDP 54, 70
 Unicast 75
 Unit date 35
 Unit reset 93
 Unit time 29, 35
 URL 25, 83
 User name 28, 34

V

Video content analysis 56

Video output 16

Video sensor 56

VRM 45

W

Watermarking 37

Window defroster 16

Bosch Sicherheitssysteme GmbH

Werner-von-Siemens-Ring 10
85630 Grasbrunn
Germany

www.boschsecurity.com

© Bosch Sicherheitssysteme GmbH, 2010

Free Manuals Download Website

<http://myh66.com>

<http://usermanuals.us>

<http://www.somanuals.com>

<http://www.4manuals.cc>

<http://www.manual-lib.com>

<http://www.404manual.com>

<http://www.luxmanual.com>

<http://aubethermostatmanual.com>

Golf course search by state

<http://golfingnear.com>

Email search by domain

<http://emailbydomain.com>

Auto manuals search

<http://auto.somanuals.com>

TV manuals search

<http://tv.somanuals.com>