

brother®

WORD PROCESSOR

WP-700D

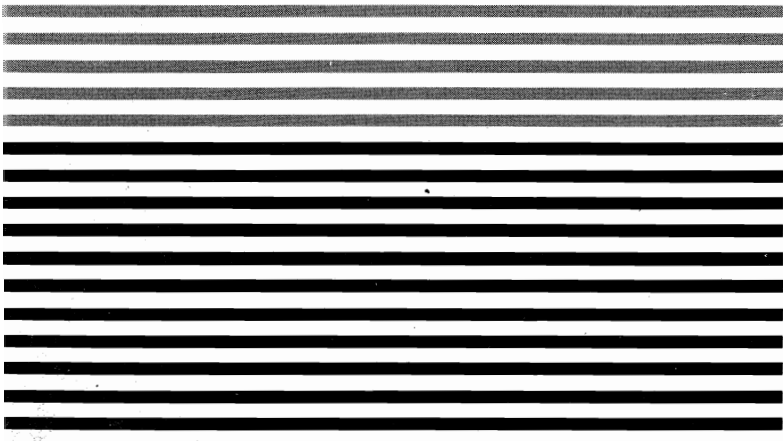

OWNER'S MANUAL

AMERICAN

Please read this manual carefully and keep it in a safe place for future reference. We recommend that you write the unit's model number and serial number in the blank space below. These numbers can be found on the rear panel of the word processor.

MODEL NO.:	SERIAL NO.:
------------	-------------

© 1994 by Brother Industries. All rights reserved.

Copyright Notice

Spelling Corrector licensed from Houghton Mifflin Company. Spelling U.S. PAT. Nos. 4,580,241 and 4,730,269. Copyright 1985, 1987 by Houghton Mifflin. All rights reserved. Reproduction or disassembly of embodied programs or database prohibited. Based upon *The American Heritage Dictionary*.

FCC NOTICE

This equipment has been tested and found to comply with the limits for a Class B digital device, pursuant to Part 15 of the FCC Rules. These limits are designed to provide reasonable protection against harmful interference in a residential installation. This equipment generates, uses and can radiate radio frequency energy and, if not installed and used in accordance with the instructions, may cause harmful interference to radio communications. However, there is no guarantee that interference will not occur in a particular installation. If this equipment does cause interference to radio or television reception, which can be determined by turning the equipment off and on, the user is encouraged to try to correct the interference by one or more of the following measures:

- Reorient or relocate the receiving antenna.
- Increase the separation between the equipment and receiver.
- Connect the equipment into an outlet on a circuit different from that to which the receiver is connected.
- Consult the dealer or an experienced radio/TV technician for help.

This equipment has been certified to comply with FCC standards, which are applied to the U.S.A. only. A shielded interface cable should be used according to FCC 15.27 (a). Changes or modifications not expressly approved by Brother International Corp. could void the user's authority to operate the equipment.

Table of Contents

Getting Started	1
How to Use this Manual 1	
Part Names	2
Setting Up	4
Removing the Packing Pieces.....	4
Switching the Word Processor On/Off.....	5
<i>Power Cord</i>	5
<i>Power Switch</i>	5
Transporting the Word Processor.....	6
Inserting Paper.....	6
<i>Paper Support</i>	6
<i>Automatic Insertion</i>	7
<i>Manual Insertion</i>	7
Precautions	8
Keyboard Layout	9
The Character Keys.....	9
The Keyboard Control Keys.....	9
The Function Keys.....	10
The Function Menu Key.....	11
On-Screen Help Information.....	11
Diskettes	12
Inserting and Removing a Diskette.....	12
Caring for Your Diskettes.....	12
Write-Protecting Your Diskettes.....	13
Initializing New Diskettes.....	14
Backing up a Diskette.....	14
Operation Overview	15
The Main Menu.....	15
Self-Demonstration.....	16
Differences between Word Processing and Typewriting	17
The Return Function.....	17
The Cancel Function.....	17
On-Screen Symbols.....	17
Automatic Page Breaks.....	17
Caps Lock vs. Shift Lock.....	18
<i>The Keyboard Shift Function</i>	18
<i>The Shift Lock Function</i>	18
<i>The Caps Lock Function</i>	18
Word Processing	19
Starting the Word Processing Application	20
WRITE/EDIT Screen	21
Status Line.....	21
Scale.....	22
Text Area.....	22
Text and Scale Cursors.....	22
Message Line.....	23
Menu.....	23
<i>Example 1: You selected CTR/RMF</i>	24
<i>Example 2: You selected FORM</i>	24

Typing on the Display	25
Hot Zone	25
Word Wrap	25
Space vs. Permanent Space	25
Hyphen vs. Permanent Hyphen	26
Superimposed Characters (Permanent Backspace)	26
Subscripts and Superscripts	27
Extra Characters	27
Accents ("Dead" Keys)	28
Automatic Page Breaks	28
Revising Text – Basic Functions	29
Moving the Text Cursor	29
<i>Moving One Position at a Time</i>	29
<i>Jumping Left and Right</i>	30
<i>Jumping to the Top or Bottom of the Text</i>	30
<i>GOTO Page</i>	30
Inserting Text	31
Deleting Text	31
<i>Deleting a Character</i>	32
<i>Deleting a Word</i>	32
<i>Deleting a Line</i>	32
Splitting and Joining Paragraphs	32
Revising Text – Advanced Functions	33
Block Operations	33
<i>Copying a Block within the Document</i>	33
<i>Copying a Block into a Different File</i>	34
<i>Recalling the Temporary File</i>	35
<i>Deleting a Block</i>	35
<i>Moving a Block</i>	36
Searching for Text	37
<i>Starting a Search</i>	37
<i>Defining a Search String</i>	38
<i>Search and Replace</i>	39
<i>Hyphen Scan</i>	40
Formatting the Page	42
Format Change Symbol	42
Left and Right Margins	42
Tabs and Decimal Tabs	43
<i>Setting Tabs</i>	43
<i>Clearing Tabs</i>	44
<i>Using Tabs while Typing</i>	44
<i>Using Decimal Tabs while Typing</i>	44
<i>Inserting Tabs</i>	45
<i>Removing Tabs</i>	45
Line Indent	45
Paragraph Indent	46
<i>Setting the Temporary Left Margin</i>	46
<i>Returning to the Original Left Margin</i>	46
Centering	47
<i>Centering Between Margins</i>	47
<i>Centering Between Tabs</i>	48
<i>Undoing Centering</i>	49
Right Margin Flush	49
<i>Undoing a Right Margin Flush Format</i>	50
Automatic Justification	50
<i>Entering Justified Text</i>	50
<i>Justifying Existing Text</i>	50

Text Emphasis.....	51
<i>Bold Face Characters</i>	51
<i>Underline</i>	52
<i>Expand</i>	53
Character Set.....	54
<i>Switching the Keyboard</i>	54
<i>Changing the Daisy Wheel</i>	54
Horizontal Positioning.....	55
<i>Screen Width vs. Paper Width</i>	55
<i>Changing the Pitch</i>	55
Vertical Layout.....	56
<i>Page Breaks</i>	56
<i>Line Spacing</i>	56
<i>Paper Size Setting</i>	57
<i>Header and Footer</i>	58
File Operation	60
Viewing the WP INDEX Screen.....	60
Saving a File.....	61
<i>Saving a New File</i>	61
<i>Saving an Edited file</i>	62
<i>Entering a File Name</i>	63
<i>Automatic Save Function</i>	63
Returning to the Main Menu.....	64
Retrieving a File.....	64
Printing a Document.....	65
<i>Starting Page Print</i>	65
<i>Starting File Print</i>	65
<i>Pausing/Resuming Printing</i>	67
<i>Daisy Wheel Changes</i>	68
<i>Stop Symbols</i>	68
Diskette Utility Functions.....	70
<i>Copying a File</i>	70
<i>Deleting a File</i>	71
<i>Renaming a File</i>	72
<i>Disk Copy</i>	72
<i>Deleting All Files</i>	74
<i>Diskette Write-Protect</i>	74
Advanced Functions	75
Double Column Printing.....	75
Data Merge.....	76
<i>Creating the Merge File</i>	77
<i>Creating a Document with Merge Symbols</i>	77
<i>Merge Printing</i>	78
Abbreviated Phrases.....	79
<i>Increasing Your Typing Speed</i>	79
<i>Understanding the Abbreviated Phrase Memory</i>	79
<i>Abbreviated Phrase Maintenance</i>	80
<i>Using the Function Menu for Other Options</i>	81
<i>Loading an Abbreviated Phrase File</i>	82
<i>Saving the Abbreviated Phrase Memory</i>	82

Typewriting	83
Starting the Typewriter Application	84
From the Main Menu	84
From the Word Processing Application	84
The Typewriter Application Screen	85
Status Line.....	85
The Hot Zone.....	85
Manual Return	85
Automatic Return.....	86
Line-by-Line Mode.....	86
Justification Mode.....	87
Basic Typing	88
Inserting Paper	88
The Cursor Keys.....	88
Setting Margins.....	88
Selecting the Pitch.....	89
Selecting the Line Space.....	89
Changing the Keyboard.....	90
Using Shift Lock and Capital Lock.....	90
Backspacing	91
<i>Normal Backspace</i>	91
<i>Fractional Backspace</i>	91
<i>Permanent Backspace</i>	92
<i>Express Backspace</i>	92
Subscripts and Superscripts.....	93
Accents and Special Symbols ("Dead" Keys).....	93
Corrections	94
Automatic Correction.....	94
<i>Correcting One Character</i>	94
<i>Erasing One Word</i>	94
<i>Erasing One Line</i>	95
<i>Relocation of the Carrier</i>	95
Manual Corrections	96
Formatting the Page	97
On-Screen Editing	97
Tabs and Decimal Tabs.....	97
<i>Setting Tabs and Decimal Tabs</i>	98
<i>Clearing Tabs</i>	98
<i>Typing with Tabs</i>	98
<i>Typing with Decimal Tabs</i>	98
Line Indent.....	99
Paragraph Indent.....	99
Text Emphasis (Style)	100
<i>Bold</i>	100
<i>Underline</i>	100
<i>Expand</i>	101
Centering and Right Margin Flush Functions	102
<i>Centering Between Margins or Between Tabs</i>	102
<i>Right Margin Flush (RMF)</i>	103

Spell Checker	105
Description of the Spell Checker	106
Spell Checker (Word Spell)	107
Checking Existing Text (WP Application)	108
<i>Starting the Spell Checker</i>	108
<i>While Checking (Suspect & Repeated Words)</i>	108
<i>Example 1</i>	109
<i>Example 2</i>	110
Checking While Typing (WP or TW Application)	111
<i>Starting the Spell Checker</i>	111
The User Dictionary	112
How the User Dictionary Works	112
Maintaining the User Dictionary	112
<i>Using the Function Menu</i>	113
Loading a User Dictionary	114
Saving the User Dictionary	115
Mail Merge	117
Starting the Mail Merge Application	118
The MERGE Screen	118
The Structure of a Merge File	118
Creating and Editing a Merge File	120
Entering Data	120
Creating a New Label	120
Changing the Width of a Label	120
Creating a New Record	121
Moving the Cursor	121
Copying Data	122
Inserting a Blank Record	122
Deleting a Record	123
Printing the Current Record	123
Preparing the Record for Merge Printing	124
File Operations	125
Saving the Merge File	125
Retrieving a Merge File	125
Printing a Merge File	125
Using the Merge Function Menu	126
Appendix	127
Character Keys	128
Standard (I) and International (II) Keyboard	128
Symbol (III) Keyboard	129
Function Keys	130
Function Menus	135
WP WRITE/EDIT Screen	135
ABBREVIATED PHRASE Screen	136
USER DICTIONARY Screen	136
INDEX Screens	136
TW Application	137
Mail Merge	137
Symbols	138
Symbols Displayed on the Scale	138
Symbols Displayed in the Text	138

Indicators	140
Error Messages	142
Troubleshooting Chart	144
Accessories	145
Changing the Daisy Wheel Cassette	145
Changing Ribbons	146
Changing Correction Tapes	147
Compatible Accessories	150
Starter Kits and Accessories	150
Cassette Ribbons / Correction Tapes	150
Daisy Wheel Cassettes	151
Daisy Wheel Samples	152
Specifications	153
Glossary	154
Index	161

Getting Started

How to Use this Manual

In order to allow first-time owners to learn about the many sophisticated functions that this word processor offers, this manual has been organized as a tutorial rather than a reference book. You are encouraged to go through the manual in a step-by-step fashion, learning about each of the functions and features one at a time. In this way you will be able to gain a full understanding of what this word processor can do and be able to make full use of its capabilities.

The last Section, "Appendix", provides an alphabetic index, a glossary, and a quick reference guide for later reference.

Part Names

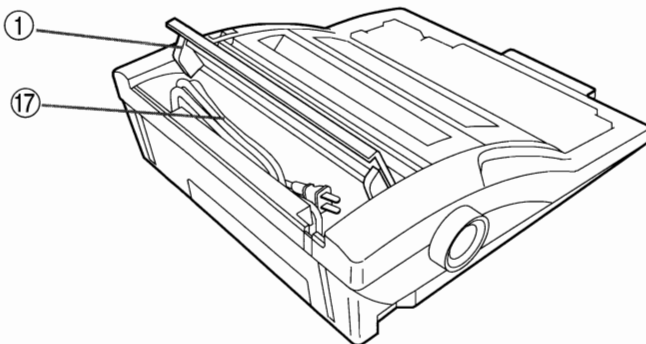
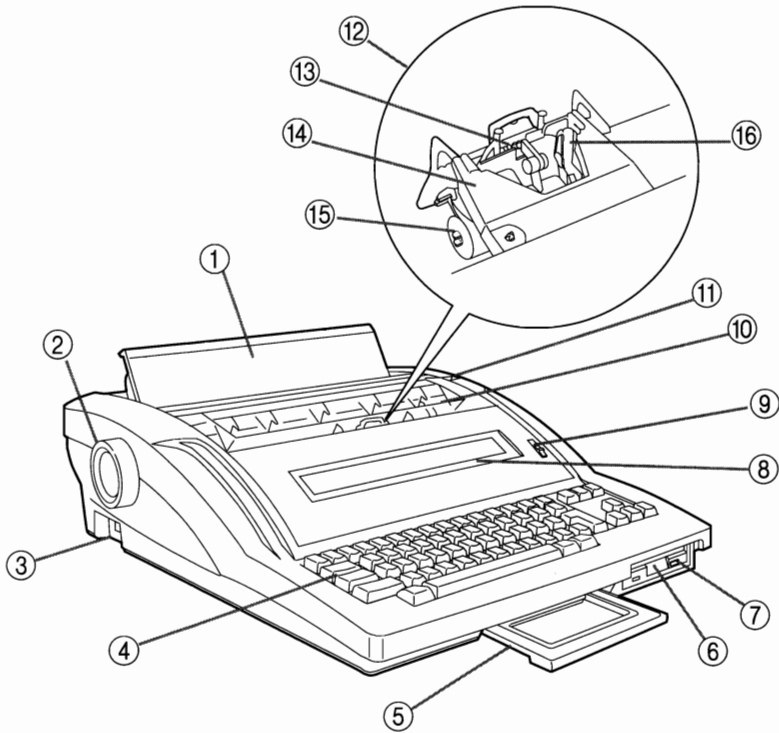

- ① **Paper Support** Supports paper for insertion / power cord compartment cover.
- ② **Platen Knob** Feeds paper manually.
- ③ **Power Switch** Turns the word processor ON and OFF.
- ④ **Keyboard** Contains character and function keys.
- ⑤ **Carrying Handle** Pulls out for easy transportation.
- ⑥ **Disk Drive** Holds data or program diskettes.
- ⑦ **Disk Eject Button** Releases an inserted diskette.
- ⑧ **LCD** Displays text and messages.
- ⑨ **Brightness Controller** Controls the display brightness.
- ⑩ **Acoustic Cover** Suppresses printing sounds and protects the printing carrier.
- ⑪ **Paper Release Lever** Unlocks the platen for paper positioning.
- ⑫ **Carrier** Supports the printing unit.
- ⑬ **Cassette Daisy Wheel** Contains print characters for each style of print.
- ⑭ **Cassette Ribbon** Transfers the characters to the paper.
- ⑮ **Correction Tape** Erases characters.
- ⑯ **Daisy Wheel Lock Lever** Releases the cassette daisy wheel.
- ⑰ **Power Cord Compartment** Stores the power cord when transporting the word processor.

Setting Up

Removing the Packing Pieces

Before you plug in the word processor, open the acoustic cover and remove the yellow plastic pieces shown in the illustrations below.

NOTES:

- If the plastic pieces are not removed, damage to the word processor may occur when the power is turned on.
- The yellow plastic pieces do not need to be re-installed unless you are re-packing the word processor for shipping.

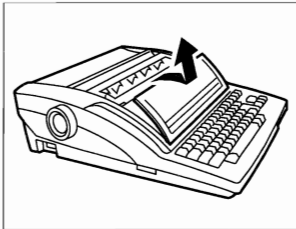

Remove the protective cover.

NOTE:

Replace the protective cover when the word processor is not in use.

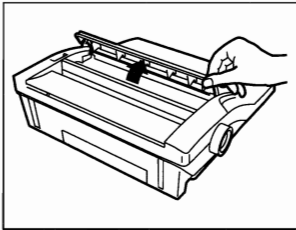

Lift the acoustic cover.

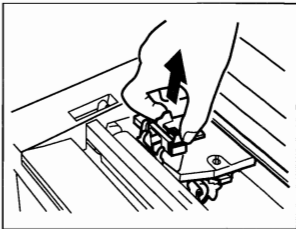

Remove the yellow plastic pieces.

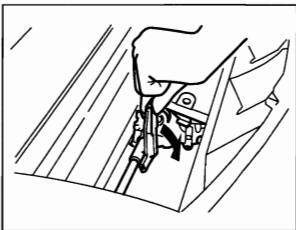

NOTE:

Be sure to reinstall the display and cover. The acoustic cover is equipped with a safety switch. Your word processor will not operate unless the acoustic cover is securely closed.

Switching the Word Processor On/Off

Power Cord

NOTE:

Please be sure both yellow plastic packing pieces have been removed from the word processor before the power is turned on.

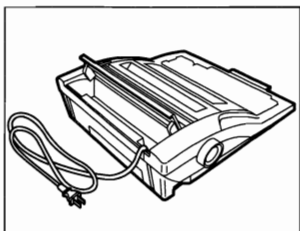

The power cord is stored in a compartment on the back of the word processor. The cover of that compartment is also used as a paper support.

NOTE:

It is a good idea to disconnect the AC plug when the word processor is not used for a long period. **Always disconnect the power cord during thunderstorms.**

Power Switch

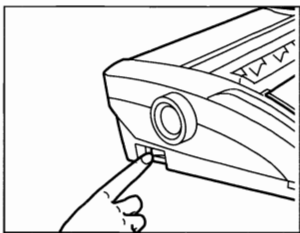

Flip the power switch on. The switch is located on the left side toward the rear of the word processor.

NOTE:

If the word processor does not respond, check the power cord and then make sure that the acoustic cover is securely latched.

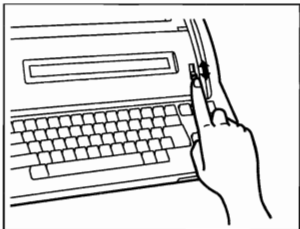

Adjust the display brightness with the brightness controller next to the screen.

NOTE:

If you switch the word processor off, wait at least 10 seconds before switching it on again. **Failure to wait 10 seconds may disrupt the start-up sequence, resulting in faulty operation and possible equipment damage.**

Transporting the Word Processor

To prepare the word processor for transportation or storage:

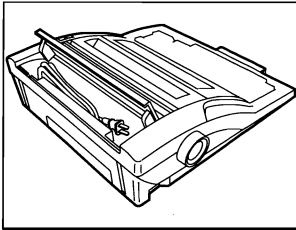

Disconnect the AC plug, and carefully fit the power cord into its compartment as shown in the illustration. Close the power cord compartment cover (paper support).

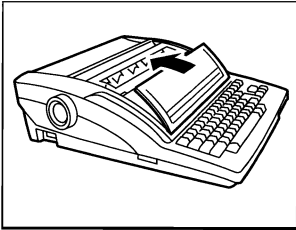

Install the protective cover. Fit the front of the cover into the holes, and lower the back part of the protective cover.

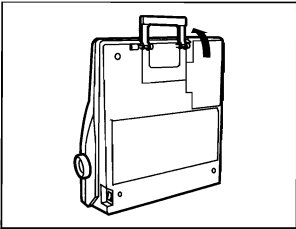

Pull out the carrying handle.

Inserting Paper

NOTE:

When using the machine as a word processor, you do not have to insert paper until you have finished editing your document and are ready to print.

Paper Support

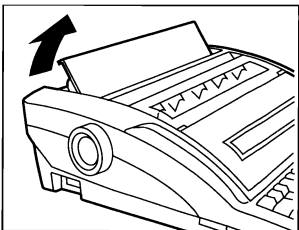

Lift the paper support.

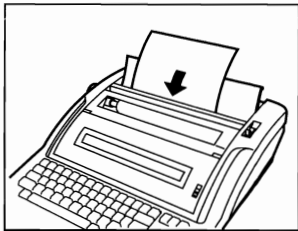

Insert paper as shown.

Automatic Insertion



Press **P INS** to automatically advance the paper to the printing position (one inch from the top).

To change that position, use **CODE** + **P UP** or **CODE** + **P DOWN**.

Manual Insertion

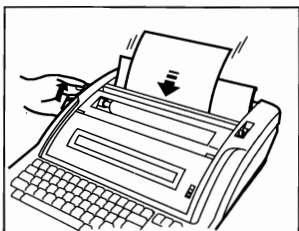

Rotate the platen knob to advance the paper.



If the paper is not properly aligned, advance the sheet half way, push the paper release lever toward the rear and manually match the corners of the paper. Pull the paper release lever back to its original position and turn the platen knob until the paper is in the desired position.

Precautions

Although this word processor is ruggedly constructed, it should not be exposed to extreme conditions. To ensure many years of reliable operation, please follow these recommendations:

- In case of malfunction, overheating, or other problems, immediately disconnect the AC plug and consult your dealer.
- Do not attempt to disassemble the word processor. It has no user-serviceable parts inside.
- Avoid dropping the word processor.
- Avoid direct exposure to sunlight and other sources of heat.
- Avoid spills. If any liquid enters the word processor, immediately disconnect the AC plug and consult your dealer.
- Avoid locations where excessive moisture or dust collect.
- Do not use sprays in the vicinity of the word processor. Aerosols are extremely harmful to the disk drive.
- Disconnect the AC plug during thunderstorms.
- Do not place heavy objects on the keyboard.
- Always keep the air vents free from obstruction to avoid overheating the word processor.
- Clean the machine housing with a soft, dry cloth only. Avoid using chemicals, solvents and detergents.
- To avoid electrical interference, do not place the word processor too close to a radio receiver or television. If the word processor is too close to a television set, the disk drive may not work properly.
- If you switch the word processor off, wait at least 10 seconds before switching it on again. Failure to wait 10 seconds may disrupt the start-up sequence, resulting in faulty operation and possible equipment damage.

Keyboard Layout

This word processor has more keys than a typewriter. In order to get a clear understanding of the keyboard, we will distinguish three classes of keys as described below. Most keys are auto-repeat; if you hold down the key, it repeats until you release the key.

In this Owner's Manual, **CODE** + a second key indicates that the **CODE** key must be held down while the second key is pressed.

The Character Keys

The character keys are used to type text. They are very similar to the character keys of a typewriter, except that this word processor accepts different daisy wheels, and therefore makes available a greater number of characters.



NOTES:

- The characters available when the keyboard is set to I (standard) appear on the left of the key tops.
- The characters available when the keyboard is set to II (international) appear on the right of the key tops.
- The characters available when the keyboard is set to III (symbol) are not shown on the key tops.

The Keyboard Control Keys

The keyboard control keys are used to modify the effect of the other keys. Pressing **SHIFT** or **CODE** alone will not produce any effect. To modify the effect of another key, you must hold down **SHIFT** or **CODE** while pressing the key to be modified.

In this Manual, such a double keystroke will be symbolized by the "+" sign.

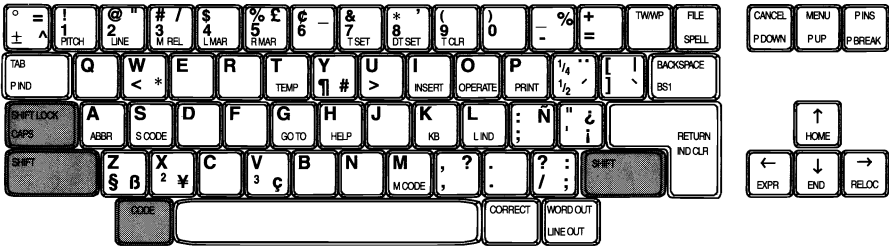

Key	Function
SHIFT + character key	Used to type an uppercase character.
CODE + another key	Used to type the character indicated in green on the key top, or to activate a function (see "Function Keys" below).
CAPS	Locks the keyboard in uppercase mode.
CODE + CAPS	Locks the keyboard in capital mode.

The Function Keys

The function keys are used to activate the various functions of the word processor. In contrast to the character keys, their effect does not depend on which daisy wheel is installed. Many functions can be activated with **CODE** + a character key. However, not all of these functions are indicated in green on the key top.

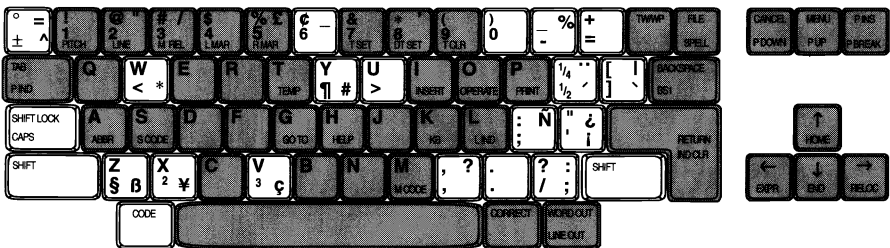

The Function Menu Key



Most of the functions of this word processor are activated by selection from a menu.

Once you get acquainted with the word processor, however, you might find that the selection from a menu is time-consuming. For faster operation, many functions of the menus can also be activated by "short-cut" keys.

On-Screen Help Information

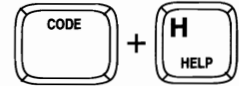

Since this product is designed to last for many years, you may need to review the meaning of a function you have not used in a while. Press **CODE** + **HELP** (**H**). Short definitions of the functions will appear on the screen. The different keys that are used for scanning the information and to return to your work are also indicated on the screen.

NOTE:

Since the details of operation are not provided, the help information is not a replacement for careful reading of this Manual.

Diskettes

This word processor accepts only the following type of 3.5-inch diskettes:

MF-2DD (Double Sided/Double Density/Double Track)

MF-1DD (Single Sided/Double Density/Double Track)

NOTE:

Your word processor cannot use high density ("HD") diskettes, so be sure to purchase only double density double track ("DD") diskettes. It is recommended that you use Brother brand diskettes.

Inserting and Removing a Diskette

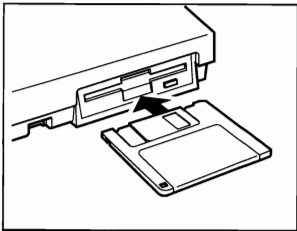

Insert the diskette as shown in the illustration.
To remove the diskette, press the eject button.

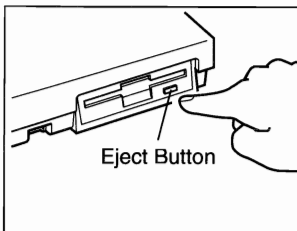

CAUTION – *The diskette may be inserted and removed when the power is either on or off. It may also be left in the drive while transporting the word processor. However, you should never insert or remove it while a message indicates that a diskette operation is in progress.*

Caring for Your Diskettes

The slightest damage, such as a scratch, or a small amount of dust on a diskette can spoil an entire file and make it unusable. The protective case of the 3.5-inch diskette protects the sensitive disk surface. (The metallic shutter automatically opens and exposes this sensitive surface only when the diskette is inserted into the drive.) Additional precautions must be taken in order to ensure reliable maintenance of your files.

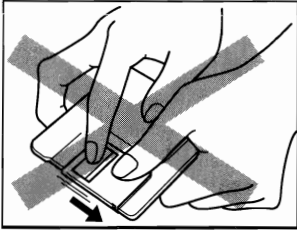

Never open the shutter of the diskette and never touch the surface directly.

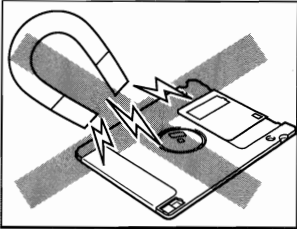

Do not use magnetic materials near the diskette.

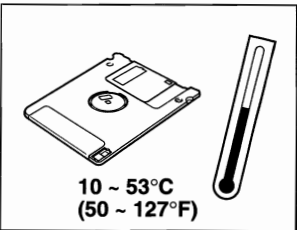

Never expose the diskette to extremely high or low temperatures.

Write-Protecting Your Diskettes

The diskettes are write-protected by software that comes with the word processor and is set through the INDEX screen menu. When write-protect is ON, you cannot erase old information or store new information on the diskette.

NOTE:

The switch on the diskette does not determine read/write capability.

Initializing New Diskettes

A diskette can be used by a system only after being “formatted” – that is, initialized by the system for specific use by that system. One frequently used analogy is that the magnetic coating on the diskette is like a blank sheet of paper. Although you can write anything anywhere on the blank sheet, things are much more organized if you add ruled lines. The initializing program creates the electronic equivalent of ruled lines on the diskette. Different systems use different formats. Standards exist, but, in general, systems cannot share diskettes without special conversion of hardware or software.

When a diskette is accessed, the word processor checks the format of the diskette. If the diskette is unformatted or has a different format, the following prompt appears:

Initialize? Press RETURN(yes) or CANCEL(no).

WARNING:

*Initializing a diskette erases any data that might be on it. If you initialize a diskette from a personal computer, for example, the files will be completely destroyed. Press **CANCEL**, if you do not wish to initialize, and insert another diskette.*

If the diskette is new or contains unimportant data, press **RETURN** to format the diskette. The word processor asks for confirmation:

Delete all files on this disk? Press Y(yes) or N(no).

Press **Y** to format the diskette, or press **N** and insert another diskette.

NOTE:

- *This word processor can recognize and read data from diskettes that have been used with some other Brother word processors. For more details about compatibility, please contact your dealer.*

Backing up a Diskette

The best insurance against losing important data is to make backups (duplicate copies) of each important file. With this word processor, you can copy individual files of your choice to another diskette, or copy the entire contents of a diskette to another diskette.

Operation Overview

The Main Menu

When you switch the word processor on, the Main menu appears:



The Main Menu displays the list of the available applications in the form of icons. To start working with an application, use the cursor keys to select an icon, and press **RETURN**. You can also press the number key indicated on the upper left side of each icon (**1** for Word processing, etc.).

The following applications are available:

- | | |
|------------------------|---|
| Word Processing | The Word Processing application (WP application) is used to type and format documents on screen. You can save the document on diskette or print it at any time. |
| Typewriter | In the Typewriter application (TW application), the word processor becomes an electronic typewriter with many advanced features normally available only on word processors. You will use the TW application most often for typing envelopes, short notes, and for filling in forms. |
| Mail Merge | The Mail Merge application is used to create and save the data that can be merged into a Word Processing document. |

Self-Demonstration

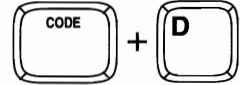

This built-in program shows you examples of what you can do with your word processor.

1. Turn the power on to display the Main menu.
2. Press **CODE** + **D**.
3. Proceed according to the instructions displayed on the screen. The following is a summary of available operations:

Key	Operation
RETURN	To advance one screen at a time.
CANCEL	To go back to the first screen of the self-demonstration.
FILE	To end the demonstration and return to the MAIN MENU.

Differences between Word Processing and Typewriting

The Return Function

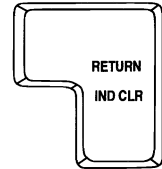

This word processor will return automatically at the end of each line. Type a paragraph as a single long line.

You still get a paragraph because of a feature called "Word Wrap". Words that do not fit on the line will "wrap" to the next line. When you press **RETURN**, a little symbol ↵ appears. This symbol is never printed. It is your signal to the word processor that "paragraph ends here".

The Cancel Function



The **CANCEL** key allows you to cancel a selected function. It is handy when you have pressed the wrong key, or when you change your mind as to how you wish the command executed after you have selected the mode

On-Screen Symbols

Special symbols appear in the text to remind you that you used a format function there. (Example: the symbol ↵ that appears when you press **RETURN** to start a new paragraph.) Such symbols are never printed on paper. (For a complete list, see "Symbols" on page 138.)

Automatic Page Breaks

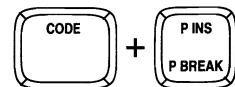

The word processor automatically breaks your text up into pages according to your specifications. The position of these automatic page breaks is flexible and will be re-adjusted for you by the machine if you modify the text.

You may also decide to force the word processor to start a new page at any point by pressing **CODE** + **P BREAK**. This inserts a symbol ↓ in the text.

Caps Lock vs. Shift Lock

The caps lock function is not the same as the shift lock function on a common typewriter. Both eliminate the need to reach for **SHIFT** to type an uppercase (capital) letter, but they differ in their effect on other keys.

The Keyboard Shift Function



You already know that holding down **SHIFT** and pressing **!** gives you "!", the exclamation mark.

While **SHIFT** is pressed, the SHIFT indicator appears on the screen. The indicator disappears as soon as you release **SHIFT**.

The Shift Lock Function



If you press **SHIFT LOCK**, the SHIFT indicator is displayed permanently, and all the characters you type are uppercase (**A** = "A", **!** = "!"). To release this mode, press **SHIFT**.

The Caps Lock Function

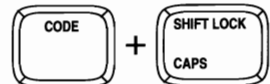

When you need to type long strings of both capital letters and numbers, such as "ACCT. NO. BC104", press **CODE** + **CAPS**. The CAPS indicator will appear on the screen to tell you that the keyboard is locked in capital mode (**A** = "A", but **!** = "1"). To release this mode, press **CODE** + **CAPS** again.

Word Processing

Starting the Word Processing Application



1. Switch the power on to display the Main Menu.
2. Use the cursor keys (**←**, **→**, **↑**, and **↓**) to select the icon for Word Processing and press **RETURN**, or press **1**. The WP INDEX screen appears:

```
<< WP INDEX >>                                REMAIN:XXX.XK
*NEWFILE          TEXT1          (XX.X)      TEXT2          (XX.X)
TEXT3          (XX.X)      TEXT4          (XX.X)      TEXT5          (XX.X)
Select a file and press RETURN. Press CANCEL to display MAIN MENU.
```

3. Use the cursor keys to select *NEWFILE and press **RETURN**. The WRITE/EDIT screen shown on the next page appears, and you can start creating your document.

WRITE/EDIT Screen

The WRITE/EDIT screen shown below appears when you start the WP application. This is the main display of your word processor. All text input and editing is done here.

When the scale is OFF

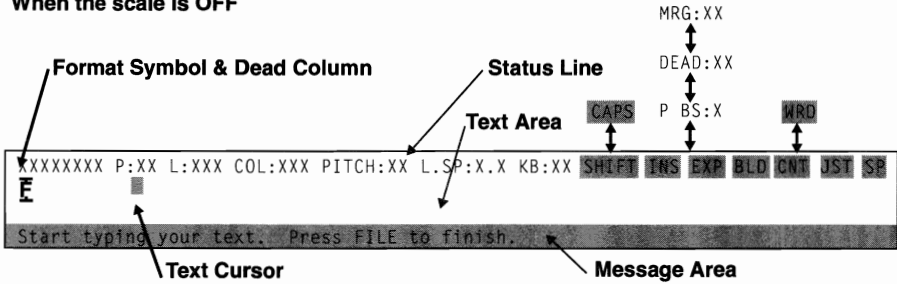

When the scale is ON

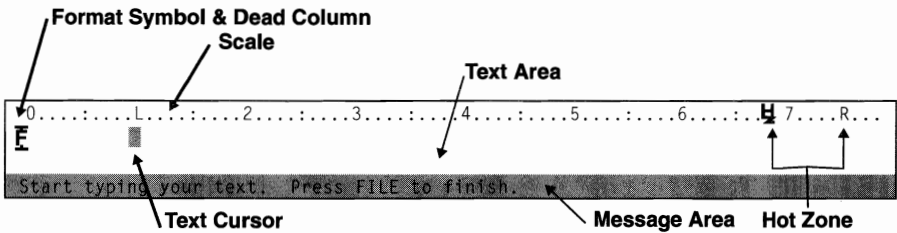

The following reminder appears on the message line (and remains until you press any key):

Start typing your text. Press FILE to finish.

Status Line

The status line reminds you where you are and how you have told the word processor to format your text. Most indicators are followed with a value (example: PITCH:10) and are always displayed. The ones on the right appear (in reversed color) only when the corresponding function has been activated because they are on/off indicators (example: BLD when the bold function is on). (For a complete list, see "Indicators" on page 140.)

Scale

The scale on the screen of the word processor is the electronic equivalent of the scale on the top of a typewriter, which assists the operator in determining the position of characters on a page. The numbers indicate the position from the left edge of the paper. Other symbols remind you of some format settings (example: L and R indicate the position of the left and right margin). (For a complete list, see "Symbols" on page 138.)

NOTES:

- By default, the scale is disabled. To display the scale, see the example under the title "Menu" on page 24.

Text Area

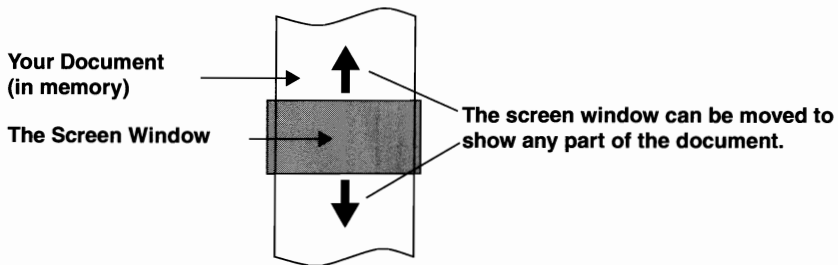

The bulk of the screen is your work area, a window into your document. Although it only shows a few lines of 79 characters at a time, if your document is longer or wider, you can move the window up, down, left, and right. The only part you cannot use is the "dead column" (to the left of column 0), which the word processor reserves for the "format change" symbol \bar{F} . Other symbols appear in the text to remind you of the format functions that you used, but will not be printed. (For a complete list, see "Symbols" on page 138.)

Text and Scale Cursors

A lighted square, the text cursor, indicates your current position in the text area. Another cursor, the scale cursor, is an underline that indicates your position relative to the left of the scale and follows horizontal movement of the text cursor.

Message Line

This line is reserved for guide messages (prompts) that ask you a question, give direction or display error messages that warn you when something is wrong. When no prompt and no error message are displayed, this line is used for your text.

NOTE:

For a list of error messages, see "Error Messages" on page 142.

Menu



When you press **MENU**, the upper line of the screen is temporarily replaced with a menu of functions. The use of the menu is very simple and will be briefly described here. As an example, we will see how to disable and enable the scale.

1. To display the menu, press **MENU**. The leftmost function (STYLE) is automatically selected and appears in reverse colors (we will call this the selection cursor).

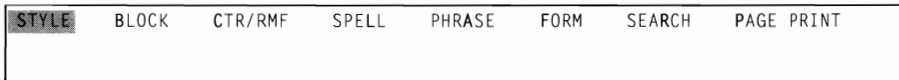

NOTE:

Pressing **CANCEL** allows you to return to the normal screen.

2. To move the selection cursor to the right or the left, use **RIGHT** and **LEFT**.
3. When the selection cursor is on the desired function, press **RETURN** or **DOWN**. A sub-menu appears below the selected function.

NOTES:

- The PAGE PRINT function is an exception: pressing **DOWN** produces a beep, and pressing **RETURN** executes the function without displaying a sub-menu.
- Once you get acquainted with the menu, you can use "accelerators" instead of steps (2) and (3). The accelerator for each function is displayed in bold on the menu. Accelerators allow you to select and execute a function without first moving the selection cursor. For example, the accelerator for CTR/RMF is "C". Typing "C" (either lower or upper case) while the "main menu" is displayed immediately shows the CTR/RMF sub-menu regardless of the position of the selection cursor.

Example 1: You selected CTR/RMF

STYLE	BLOCK	CTR/RMF	CENTERING	FORM	SEARCH	PAGE PRINT
			RIGHT MARGIN FLUSH			

NOTES:

- This sub-menu is used to center the text or to align it flush to the right margin. (For details see "Centering" on page 47, and "Right Margin Flush" on page 49.)
- New bold characters indicate the accelerators for the functions of the sub-menu. For example, to select and activate the right margin flush function, you can type "R".
- Pressing **CANCEL** will return you to the "main menu". However, when a sub-menu is displayed, you can select another function without returning to the "main menu". Simply use **←** and **→**.
- Instead of the menu process, you can access the right margin flush function by pressing **CODE** + **R** at the WRITE/EDIT screen. This quick access is called a "short-cut". (See "Function Menus" on page 135 for a complete list of short-cut keys.)

Example 2: You selected FORM

STYLE	BLOCK	CTR/RMF	SPELL	PHRASE	FORM	PAPER SIZE	PRINT
						HEADER	
						FOOTER	
						SCALE LINE ON/OFF	

Let's use this example to show how to turn the scale on/off.

1. Move the selection cursor to FORM and press **RETURN**, or type "F".
 2. Use **↑** and **↓** to select SCALE LINE ON/OFF and press **RETURN**. You are back to the WRITE/EDIT screen. If the scale was displayed, it is now disabled, and vice-versa.
- **Accelerator:** Instead of (2), type "S".

When the scale is OFF

```
XXXXXXXX P:XX L:XXX COL:XXX PITCH:XX L.SP:X.X KB:XX
E
```

When the scale is ON

```
0.....L.....2.....3.....4.....5.....6.....H 7.....R...
E
```

When the scale line is ON, the status line is displayed by pressing **CODE**.

Typing on the Display

Type your text just as you would on a typewriter. The text appears on the screen instead of being printed on paper.

If you make a mistake, use **BACKSPACE** or **CORRECT** to delete. For more details about corrections, see “Revising Text – Basic Functions” on page 29.

You can print your text after you have created it. See “Printing a Document” on page 65.

When your text is complete, see “Saving a File” on page 61.

Hot Zone

The last six columns before the right margin are defined as the “hot zone”. The  symbol on the scale corresponds to the point at which a typewriter bell would ring to warn you that you are about to run into the right margin. The word processor knows how to break text so that it automatically “wraps” to the next line.

Word Wrap

The “word wrap” function allows you to type a paragraph continuously without being concerned about carrier returns. In the hot zone, when a word is going to extend beyond the right margin, the word and the cursor will be moved to the next line automatically. You need only to press **RETURN** to break a line and start a new paragraph.

The word wrap function is always active on the word processor. This feature permits continuous typing and helps build typing speed. The text cursor automatically moves to the next line whenever a space or hyphen is typed in the hot zone.

Space vs. Permanent Space

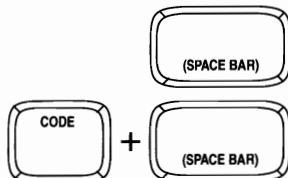



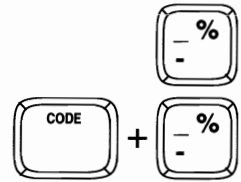

Spaces entered by pressing **(SPACE BAR)** are word separators called “soft” spaces. When entered in the hot zone, they force the cursor to move to the next line. In justify mode, the “soft” spaces are adjusted to produce an even right margin. (See “Automatic Justification” on page 50.)

Permanent spaces entered by pressing **CODE** + **(SPACE BAR)** are special spaces that link words together, protecting them from being separated on different lines. A permanent space is displayed with the symbol  and is considered part of the two words it links. Such a space is never adjusted by the automatic justification function – and does not cause the cursor to jump to the next line when entered in the hot zone.

Hyphen vs. Permanent Hyphen



Typing a hyphen () in the hot zone automatically sends the cursor to the next line. This becomes a “soft” hyphen, displayed as a dotted hyphen, and will disappear if subsequent revisions or re-formatting – a change of margins, for instance – moves the word out of the hot zone.

A permanent hyphen, entered with  +  , is for those words that always require a hyphen (mother-in-law, for example). In the hot zone, a permanent hyphen does not send the cursor to the next line. Outside the hot zone, all hyphens are permanent, so it is not necessary to use .

Superimposed Characters (Permanent Backspace)

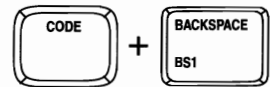



It is possible to create characters that are not available on the keyboard (“¥”, for example) by superimposing two characters.



1. Type the first character (“Y” in our example).

NOTE:

Enter the characters in either order, but start with the one you want to appear in the text area.

2. Press  +  . The first character appears now in reversed color, and the cursor moves next to the P BS indicator on the status line. If the Scale was displayed, the Status Line is automatically displayed.
3. Type the second character (“=” in our example) on the status line. As soon as the second character is typed, the cursor moves back to the text area and you are ready to resume normal typing.

NOTES:

- *When you move the cursor back to the first character (press  at this point, for example), the second character re-appears next to the P BS indicator (if the Status Line is currently displayed).*
- *To delete superimposed characters, delete the first character (use  or ).*

Subscripts and Superscripts

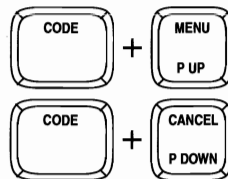

The word processor allows you to enter and print subscripts and superscripts. The procedure parallels what you would do on a typewriter except that, instead of physically rotating the platen, you press **CODE** + **P DOWN** and **CODE** + **P UP**.

NOTES:

- Characters in subscript and superscript are displayed on the same line as normal characters. When you input a subscript or superscript or move the cursor to a subscript or superscript, however, only half of the cursor appears (lower-half for subscripts, and upper-half for superscripts).
- The word processor prints subscripts and superscripts the same distance (1/12 inch) below or above the line, regardless of the current line spacing.

Try to enter "e=mc²".

1. Type "e=mc".
2. Press **CODE** + **P DOWN**.
3. Type "2".
4. Press **CODE** + **P UP**.

NOTES:

- To enter subscripts, proceed in the same way as above, but reverse the **CODE** + **P DOWN** and **CODE** + **P UP** keys.
- Each pair of keys (**CODE** + **P DOWN** and **CODE** + **P UP**) cancels the other, and the two pairs must always be used in combination. If you try to press one of the pairs more than once, the word processor beeps.

Extra Characters

The extra characters are those marked in green on your keyboard (for example, ">"). To enter such a character, hold **CODE** down and press the character key.

NOTE:

If a green character appears on the right of a key (for example "ß"), it means that the character is available only with KB II (international keyboard).

Accents (“Dead” Keys)

This word processor’s multilingual keyboard supports the accented vowels of such languages as French, German, and Spanish.

1. When typing, you must press **CODE** + **KB** (**K**) to switch the KB indicator on the status line to **II** (international) or **III** (symbol). (See “Character Set” on page 54.)
2. When printing, you must have the appropriate daisy wheel. (See “Changing the Daisy Wheel Cassette” on page 145.) Remember that the accented characters and other special characters on the international or symbol keyboards can be printed only if you install the appropriate daisy wheel.
3. Only the base character is entered in the text area. The accent is entered next to the indicator **DEAD** on the status line.

If you have ever used a typewriter, you already know the basic procedure: Type the accent and then the base character. Unlike regular keys, the accent keys are “dead” – that is, the cursor does not move afterward so the base character appears under the accent. Make sure that the keyboard is set to **KB:II** (international), and try the following example.

1. Type the accent “^”. The accent appears next to the indicator **DEAD**. If the Scale was displayed, the Status Line is automatically displayed. The cursor is reversed and waits for a base character to be input. You are allowed to input a maximum of two dead characters. If you make a mistake, press **CANCEL** or **CORRECT** to delete the dead character(s) and retype.
2. Type the letter “o”. The letter with its accent “ô” now appears in the text area.

NOTES:

- *With some combinations of accents and base characters (such as Y and ^), the base character appears alone and in reverse color in the text area. When you move the cursor to the base character (press **←** at this point, for example), the accent re-appears next to the **DEAD** indicator (only when the status line is displayed).*
- *To delete an accented character, proceed as you would for a normal character (use **BACKSPACE** or **CORRECT**).*

Automatic Page Breaks

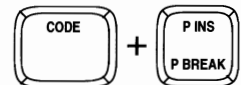

The word processor automatically breaks your text up into pages according to your specifications. (See “Vertical Layout” on page 56.) The position of these automatic page breaks is flexible and will be re-adjusted for you by the word processor if you modify the text.

You may also decide to force the word processor to start a new page at any point by pressing **CODE** + **P BREAK**. This inserts a symbol ↓ in the text (and forces any text beyond that point to the next page).

Revising Text – Basic Functions

Moving the Text Cursor





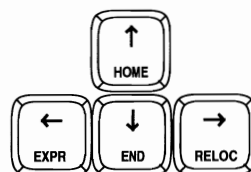

To make a revision, you must first go to that part of the document. A word processor uses a text cursor to indicate your current position in the document.

Moving One Position at a Time



The cursor keys , , , and  move the text cursor one position in the direction of the arrow on their key tops.

NOTES:

-  and  will not move the cursor beyond the margins.
- Pressing  at the end of a line sends the cursor to the beginning of the next line; pressing  then sends it back to the end of the previous line.
- If the cursor is at the top or bottom of the text area, cursor up and down keys,  and , automatically shift (“scroll”) the text down or up to show you more – unless there is no more text because you are at the beginning or the end of the document.

One Line Up

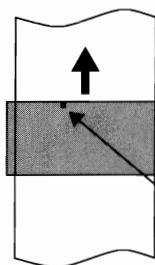

One Line Down

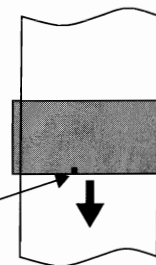

Cursor

Jumping Left and Right

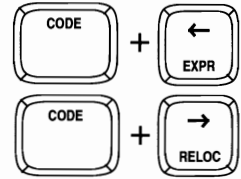

The Express Backspace and Relocation functions take you to the beginning and end of the current line of text, respectively.

NOTES:

- **CODE** + **EXPR** moves the cursor to the left margin. If you press **CODE** + **M REL** first at the left margin position, however, it goes all the way to the left end. When you are in the middle of an indented paragraph (See "Paragraph Indent" on page 46), it goes back to the temporary left margin.
- **CODE** + **RELOC** moves the cursor to the end of the current line but does not jump past a symbol that signals the end of a paragraph (↵, ¶, and ↓). If you press **CODE** + **M REL** at the right margin position, the cursor goes all the way to the right end.

Jumping to the Top or Bottom of the Text

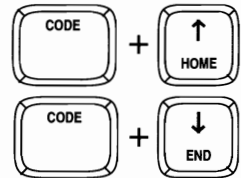

CODE + **HOME** scrolls the text all the way to the top of the document. **CODE** + **END** scrolls the text all the way to the bottom of the document.

GOTO Page

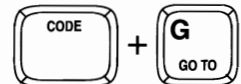

The GOTO Page function moves the cursor immediately to the beginning of any page of the document with a single operation.





1. Press **CODE** + **GOTO** (**G**). The word processor asks you to type in the number of the page you wish to move the cursor to.

PAGE: 1

2. Type the desired page number, then press **RETURN** to move the cursor to that page.

NOTES:

- If you enter an incorrect page number, you may change it using **CORRECT**, or stop the operation with **CANCEL**.
- If you enter a page number that is higher than the number of the last page, the cursor will jump to the last page.
- Instead of typing a page number, you may press one of the cursor keys just after pressing **CODE** + **GOTO** (**G**):

CODE + GOTO , then	Function
	Moves the cursor to the beginning of the current page; moves to the beginning of the previous page when the cursor is at the beginning of the current page.
	Moves the cursor to the beginning of the next page.
	Moves the cursor to the beginning of the document.
	Moves the cursor to the end of the document.

Inserting Text

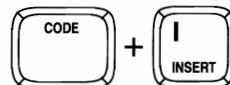

Pressing **CODE** + **INSERT** (**I**) switches the word processor between insert and overwrite modes, and turns the INS indicator on and off accordingly.

In overwrite mode (indicator INS off), each character you type replaces the current character. You type over the existing data and your new data replaces the old data. (Overwrite is the “default,” that is, every time power is turned ON, the word processor starts in overwrite.)

In insert mode (indicator INS on), the characters you type appear in front of the cursor, the rest of the line automatically moves to the right and, if necessary, the last word moves to the next line.

NOTE:

Since deleting unnecessary characters is usually easier than retyping characters that have been deleted, it's a good idea to make sure that the word processor is in the insert mode before you start revising.

Deleting Text

You can delete text at four different levels:

- a character at a time
- a word at a time
- a line at a time
- a block at a time (See “Deleting a Block” on page 35.)

Whichever level you choose, the word processor automatically closes up the gap and reformats the text to fit the margins and the page length.

Deleting a Character

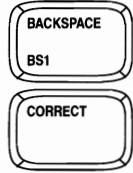

Press **BACKSPACE** or **CORRECT** to delete one character to the left of the cursor.

NOTE:

These keys also delete paragraph end symbols ¶, ¶, and ↓ except when these symbols are located just before a format symbol ¶ or a centering symbol ¶.

Deleting a Word

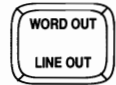

To delete a word, position the cursor on the space immediately following the word and press **WORD OUT**. Pressing **WORD OUT** removes any portion of a word to the left of the cursor, up to the previous blank space.

NOTE:

Use this feature when you mistype a word and typing it over is faster than otherwise correcting it.

Deleting a Line

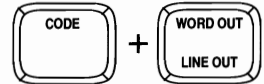

To delete a line, position the cursor anywhere after the last character of the line and press **CODE** + **LINE OUT**. Pressing **CODE** + **LINE OUT** removes any portion of a line to the left of the cursor, up to the beginning of the line.

Splitting and Joining Paragraphs

1. Press **CODE** + **INSERT** (I) if the INS indicator is off.
2. Position the cursor at the point you want to split and press **RETURN** to insert a ¶ symbol.

Position the cursor at the beginning of the second paragraph, and press **BACKSPACE** or **CORRECT** to delete the ¶ symbol of the first paragraph.

NOTE:

It is not possible to join two paragraphs that have two different formats (e.g. margin settings).

Revising Text – Advanced Functions

Block Operations

A block can be copied, deleted, or moved to another part of the document.
A block can also be copied into a different file.

Copying a Block within the Document

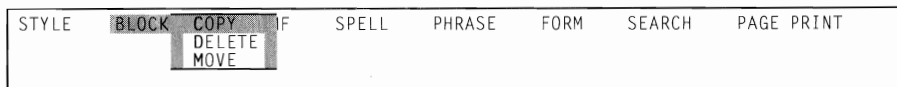
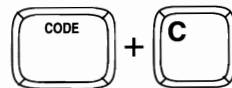

1. Position the cursor on the first character of the block you want to copy.
2. Press **MENU** to display the menu.
3. Use **←** and **→** to select BLOCK, and press **RETURN** or **↓**.
 - **Accelerator:** Instead of (3), type "B".
4. Use **↑** and **↓** to select COPY and press **RETURN**.
 - **Accelerator:** Instead of (4), type "C".
 - **Short cut:** Instead of (2), (3) and (4), press **CODE** + **C**.

Move cursor to block end. Press RETURN or to store temporary file press TEMP.

5. Move the cursor to the end of the block to be copied. As you move the cursor, the block is selected (reverse image). You may move the cursor back toward the beginning of the block to deselect it. All key combinations used to move the text cursor can be used when selecting a block, (See "Moving the Text Cursor" on page 29.)
6. When the block to be copied is selected, press **RETURN**.

Move cursor to destination for blocked text and press RETURN.

7. Move the cursor to the location where you want to insert the selected block and press **RETURN**. The block is automatically copied to that position and the document is reformatted to conform to the modified sections of the document. (See "Formatting the Page" on page 42.)

NOTES:

- The block is inserted regardless of the current mode (insert or overwrite). This means that the block will never overwrite text at the destination position.
- Press **CANCEL** at any step to cancel the function.

- Since the block copy operation increases the size of your document, the word processor may run out of memory. If this happens, the copy operation is cancelled and the following message appears:

Not enough memory remaining.

You must either first delete a portion of the document to free some space, or try to copy only a smaller block.

Copying a Block into a Different File

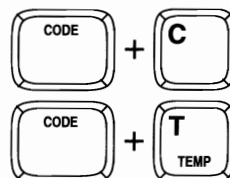

STYLE BLOCK COPY SPELL PHRASE FORM SEARCH PAGE PRINT
 DELETE
 MOVE

A portion of the memory is reserved for a temporary file in which you may copy a block of the current document. Later, the contents of the temporary file can be recalled for insertion in the same document or in any other document you are working on. This means that the temporary file can be used to copy a block of text from one file into another file.

You may copy a block stored in the temporary file as many times as you want. Each time you store a new block in the temporary file, you will erase the previous contents of the temporary file.

On the other hand, you can recall the contents of the temporary file as many times as you want without altering it.

NOTES:

- The temporary file is erased after the power is turned off, a DISK COPY function or a Mail Merge operation is completed.
 - The temporary file may contain up to 4K bytes (about 4,000 characters).
1. Position the cursor on the first character of the block you want to copy.
 2. Press **MENU** to display the menu.
 3. Use **←** and **→** to select BLOCK, and press **RETURN** or **↓**.
 - **Accelerator:** Instead of (3), type "B".
 4. Use **↑** and **↓** to select COPY and press **RETURN**.
 - **Accelerator:** Instead of (4), type "C".
 - **Short cut:** Instead of (2), (3) and (4), press **CODE** + **C**.

Move cursor to block end. Press RETURN or to store temporary file press TEMP.

5. Move the cursor to the end of the block to be copied. As you move the cursor, the block is selected (reverse image). You may move the cursor back toward the beginning of the block to deselect. All key combinations used to move the text cursor can be used when selecting a block, (See "Moving the Text Cursor" on page 29.)
6. When the block is selected, press **CODE** + **TEMP** (**T**) to store the file in temporary memory. DO NOT press **RETURN**.

NOTE:

Press **CANCEL** at any step to cancel the function.

Recalling the Temporary File

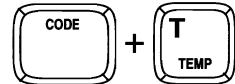

The contents of the temporary file can be recalled and inserted into any file.

1. Position the cursor on the location where you want to insert the contents of the temporary file.
2. Press **CODE** + **TEMP** (**T**). The following message appears:

You can recall temporary file. To recall temporary file press RETURN.

3. Press **RETURN**. The text saved into the temporary file will now be inserted into the document at the cursor position.

Deleting a Block

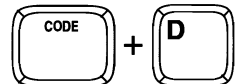

STYLE **BLOCK** COPY F SPELL PHRASE FORM SEARCH PAGE PRINT
 DELETED
 MOVE

1. Position the cursor on the first character of the block you want to delete.
2. Press **MENU** to display the menu.
3. Use **←** and **→** to select **BLOCK**, and press **RETURN** or **↓**.
 - **Accelerator:** Instead of (3), type "B".
4. Use **↑** and **↓** to select **DELETE** and press **RETURN**.
 - **Accelerator:** Instead of (4), type "D".
 - **Short cut:** Instead of (2), (3) and (4), press **CODE** + **D**.

Move cursor to end of block to delete and press RETURN.

- Move the cursor to the end of the block to be deleted. As you move the cursor, the block is selected (reverse image). You may move the cursor back toward the beginning of the block to deselect. All key combinations used to move the text cursor can be used when selecting a block, (See "Moving the Text Cursor" on page 29.)
- When the block to be deleted is selected, press **RETURN**. The word processor asks for confirmation:

Delete? Press RETURN(yes) or CANCEL(no).

- If you press **RETURN**, the block (displayed in reverse image) is deleted, and any text following the block is reformatted to conform to commands in force for that section of the document. (See "Formatting the Page" on page 42.)

Moving a Block

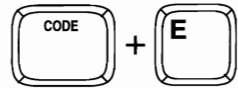

- Position the cursor on the first character of the block you want to move.
- Press **MENU** to display the menu.
- Use **←** and **→** to select BLOCK, and press **RETURN** or **↓**.
 - Accelerator:** Instead of (3), type "B".
- Use **↑** and **↓** to select MOVE and press **RETURN**.
 - Accelerator:** Instead of (4), type "M".
 - Short cut:** Instead of (2), (3) and (4), press **CODE** + **E**.

Move cursor to end of block to move and press RETURN.

- Move the cursor to the end of the block to be moved. As you move the cursor, the block is selected (reverse image). You may move the cursor back toward the beginning of the block to deselect. All key combinations used to move the text cursor can be used when selecting a block, (See "Moving the Text Cursor" on page 29.)
- When the block to be moved is selected, press **RETURN**.

Move cursor to destination for blocked text and press RETURN.

- Move the cursor to the location where you want to insert the selected block and press **RETURN**. The selected block is automatically transferred to that position and the document is reformatted to conform to the modified sections of the document. (See "Formatting the Page" on page 42.)

NOTES:

- The block is inserted regardless of the current mode (insert or overwrite). This means that the block will never overwrite text at the destination position.
- Press **CANCEL** at any step to cancel the function.

Searching for Text

In addition to using the cursor keys to move throughout your text, you may find any position in your file quickly by using the search function.

The word processor allows you to automatically scan the document for all occurrences of a specific piece of text (called a "string") and, at your option, replace all or some of those occurrences with another string. (See "Search and Replace" on page 39.)

A string may be up to 63 characters long, and may include "dead" and superimposed characters. (See "Defining a Search String" on page 38.)

Starting a Search

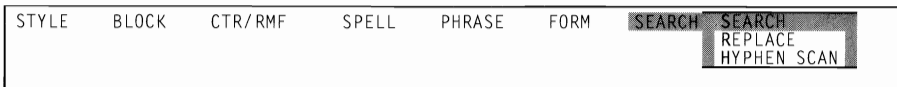

This function scans the text from the current text cursor position and pauses when the string is found, waiting for you to tell it whether to stop there or proceed to the next occurrence.

1. Position the cursor at the beginning of the section that you wish to scan. If you want to scan the entire document, for example, move the cursor to the beginning of the text.
2. Press **MENU** to display the menu.
3. Use **←** and **→** to select SEARCH, and press **RETURN** or **↓**.
 - **Accelerator:** Instead of (3), type "R".
4. Use **↑** and **↓** to select SEARCH and press **RETURN**.
 - **Accelerator:** Instead of (4), type "S".

Type search word(s). Press RETURN to start search.

SEARCH :

5. Enter the text you are looking for and press **RETURN**.
6. Wait for the word processor to find the first occurrence. The following prompt will appear:

Press RETURN to search again, or press CANCEL to stop search.

7. If this is the place you are looking for, press **CANCEL** and do the necessary editing. If you wish to proceed to the next occurrence, press **RETURN** to continue the search.

NOTE:

When there are no more occurrences, the following message appears, and the prompt will disappear when you hit a key.

Word(s) not found.

- Resume normal word processor operation or go back to step (1) to search for another string – or for the same string again. Since the search string remains in memory until you define another or turn the power off, you will not have to re-enter it in step (5) when you search repeatedly for the same string, and exit to make changes.

Defining a Search String

- The 63-character limit refers to the number of characters you see on the screen. An accented character (made with a dead key) or superimposed characters (made with a permanent backspace) count as a single character even if it takes two or more keystrokes to type.
- The search function distinguishes between upper and lower case letters. For example, if you specify “ALPHA”, it will not stop at “alpha” or “Alpha”.
- Each space that you type (with **(SPACE BAR)**) in the string or in the text counts as one character.
- The string input area initially appears as a continuous underline. Everything before the trailing underline is considered part of the string. The string shown below, for example, is five characters long because it ends with two spaces.

Type search word(s). Press RETURN to start search.

SEARCH :AAA

- The search function stops at every string that matches the specified string – even if the match is inside a word. If the specified string is “at”, it stops at “at” of “hat”, “attention”, etc. If you wish to search only for the word “at”, specify “_at_”, leaving a space on each side of the word.
- The search function ignores “soft spaces” that are added by the justify function and hyphens other than permanent ones. If “word processor” is the specified string, the function will stop at “word__processor” if there is an extra space inserted by the justify function and at “word pro-cessor” if the hyphen was typed in the hot zone.
- The search string cannot contain styles such as bold, underline, subscript, or superscripts because the search function ignores them. If you specify “A2”, it stops at “A2”, “A²”, “A₂” – and all combinations with bold and underline as well.
- Pressing **(CANCEL)** during string input stops the search function, but the string remains in memory until you define another search string, or turn the power off.

Search and Replace

STYLE	BLOCK	CTR/RMF	SPELL	PHRASE	FORM	SEARCH	SEARCH REPLACE HYPHEN SCAN
-------	-------	---------	-------	--------	------	--------	----------------------------------

The search and replace function is just the search function with the option of replacing some or all occurrences with another text string. Applications include quick correction of a misspelled or mistyped word everywhere that it occurs (from "conveyer" to "conveyor" or vice-versa), replacement of key words (from "brother" to "sister"), and capitalizing key words for emphasis (from "word processor" to "WORD PROCESSOR").

The word processor automatically reformats your document if the replacement word is not the same length as the original.

1. Position the cursor at the beginning of the section that you wish to scan. If you want to scan the entire document, for example, move the cursor to the beginning of the text.
2. Press **MENU** to display the menu.
3. Use **←** and **→** to select SEARCH, and press **RETURN** or **↓**.
 - **Accelerator:** Instead of (3), type "R".
4. Use **↑** and **↓** to select REPLACE and press **RETURN**.
 - **Accelerator:** Instead of (4), type "R".

Type search and replace word(s). Press ↑, ↓ to select, RETURN to start search.

SEARCH : _____
REPLACE: _____

5. Enter both the text that you wish to look for and the replacement text. Use **↑** and **↓** to shift between the two input areas and press **RETURN** when input is completed.

Global? Press RETURN(yes) or TAB(no).

6. If you press **RETURN**, all occurrences from the cursor position to the end of the document will be automatically replaced. When the function has been completed, the cursor will move to the end of the file and return to the normal edit mode. To stop the function in progress, press **CANCEL**.
If you press **TAB**, the word processor will stop at the first occurrence, and display the following message:

Press RETURN to replace word(s), TAB not to replace word(s), CANCEL to exit.

7. To replace this occurrence, press **RETURN**. The word processor carries out the change, then stops at the next occurrence and displays the above message again.

To search for the next occurrence without replacing, press **TAB**. The word processor stops at the next occurrence and displays the above message again.

To stop searching and return to the normal edit mode, press **CANCEL**. If you mistakenly press this key, you may re-start from step (1). Since the search and replace strings remain in memory until you define others, you will not have to re-enter them in step (5).

NOTE:

When there are no more occurrences, the following message appears, and will automatically disappear when you hit any key.

Word(s) not found.

NOTE:

If you repeatedly replace strings with longer ones in a very long document, you may run out of memory. In such a case, the function is cancelled and the following message appears:

Memory full.

The message will remain until you delete some portion of the document to free some memory space.

Hyphen Scan

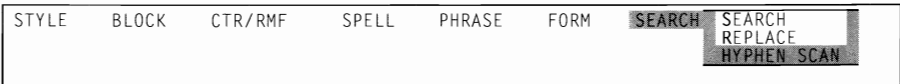

A problem arises with the word wrap function when the distance between margins is small, or when typing a text in languages like German using very long words. Since the word wrap function automatically transfers a word that cannot fit in the current line to the next line, excessively long blank spaces may appear, resulting in a poor layout.

The hyphen scan function automatically detects such long blank spaces and gives you a chance to hyphenate the long words. It allows you to type your text without making any manual hyphenations (except, of course, a permanent hyphen).

1. After your text is typed, position the cursor at the beginning of the section that you wish to scan. If you want to scan the entire document, for example, move the cursor to the beginning of the text.
2. Press **MENU** to display the menu.
3. Use **←** and **→** to select SEARCH, and press **RETURN** or **↓**.
 - **Accelerator:** *Instead of (3), type "R".*

4. Use **↑** and **↓** to select HYPHEN SCAN and press **RETURN**.
 - **Accelerator:** *Instead of (4), type "H".*
5. The hyphen scan function will scan your text down from the cursor position and search for lines containing blank spaces longer than the six columns of the hot zone. The long word that has been transferred to the next line by the word wrap function is displayed in reverse colors. The following message appears:

Move cursor, press RETURN to hyphenate, TAB to continue, CANCEL to exit.

6. If you want to hyphenate this word, position the cursor at the most suitable position and press **RETURN**. The word will be hyphenated and the portion of the word to the left of the hyphen will be transferred to the previous line. The hyphen scan function will search for the next occurrence of a long blank space.

If you want to skip this occurrence and keep the word without a hyphen, press **TAB**. The whole word will be transferred to the next line, where it was originally, and the hyphen scan function will search for the next occurrence of a long blank space.

Press **CANCEL** if you want to end the hyphen scan function.

Formatting the Page

An important advantage to a word processor is that it allows you to change the left, right, top, and bottom margins, tab stops, and other layout parameters on the screen without having to retype. The word processor automatically adjusts the text to fit the new width and page length.

Format Change Symbol

The word processor reserves the dead column of the text area (column 0) for the format change symbol F . Each time you change the format, – that is, the left or right margin, tab stops, justification, etc. – this symbol appears in the dead column at the beginning of the paragraph, and the word processor automatically adjusts the text to fit the new setting. These new settings affect not only the current paragraph, but also all subsequent text up to the next format change symbol. The text above the symbol remains unchanged.

Left and Right Margins

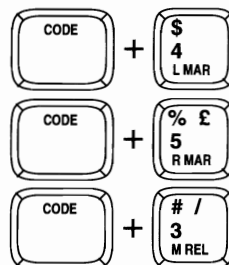

The left and right margins are set to columns 10 and 75 respectively each time you start with a *NEWFILE. Margins can be relocated at any time, before, during, or after typing the text. Each time you move the left or right margin, a F symbol appears in the dead column of the first line of the current paragraph. A F symbol always follows the \leftarrow , \leftarrow , or \downarrow symbols. The new setting affects the whole document from the current line up to the next F symbol. If there is some text already input in the affected portion, it will automatically be readjusted to fit between the new margins. The text above the F symbol remains untouched.

1. Move the cursor to the new position for the left or right margin while observing the scale. (See "Moving the Text Cursor" on page 29.) If the new position is beyond the current margins, press **CODE** + **M REL** when the cursor is on the margin to allow the cursor to move freely.
2. Press **CODE** + **L MAR** to set the new left margin, or **CODE** + **R MAR** to set the new right margin. The L or R symbol on the scale will move accordingly.

NOTES:

- When setting new left or right margins, tabs or decimal tabs, we recommended that the scale line be displayed.
- If you mistakenly press **CODE** + **M REL** when there is no need to modify the margins, press **CANCEL** to resume normal editing.
- The minimum distance between margins is set to two inches. The maximum distance is nine inches (maximum printing width of the word processor) and, in terms of columns, depends on the pitch as indicated in the following table:

Pitch (characters per inch)	Distance Between Margins (columns)	
	Minimum # characters	Maximum # characters
10 (Pica)	20	90
12 (Elite)	24	108
15 (Micron)	30	135

Tabs and Decimal Tabs

If you have been using a typewriter, you already know how convenient tabs are for aligning text. Decimal tabs provide additional convenience when typing numbers. Decimal tabs automatically align a column of numbers at the decimal point instead of the first character. The scale indicates these two types of tabs with **T** for normal tabs, and **D** for decimal tabs.

Setting Tabs

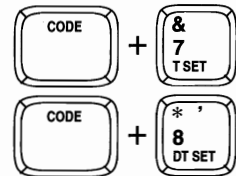

You may change tab stops at any time – before, while, or after typing the text.

1. Move the cursor to the position where you want a tab. (See “Moving the Text Cursor” on page 29.)
2. Press **CODE** + **T SET** to set a normal tab stop, or **CODE** + **DT SET** to set a decimal tab stop at the current cursor position. The corresponding symbol **T** or **D** appears on the scale. Up to 30 tab and decimal tab stops can be set. Setting a tab stop where you already had a decimal tab stop replaces the **D** with a **T** and vice-versa.

NOTES:

- When the *NEWFILE is opened, there are no tab stops set.
- Since the pitch determines the actual position on the printed page, the columns may appear at undesired positions if you change the pitch of a table formatted with tabs and decimal tabs.

Clearing Tabs

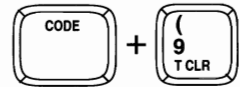

1. To clear a single tab or decimal tab, move the cursor to that position and press **CODE** + **T CLR**.
2. To clear all tabs and decimal tabs, hold down **CODE** + **T CLR** until the following message appears:

All tabs cleared.

Using Tabs while Typing

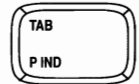

1. Press **TAB** to move the cursor to the next tab stop to the right. A symbol → appears on the screen just before the new text cursor position to remind you that there is now a tab in the text.

NOTE:

If there is no tab stop to the right, the cursor moves to the right margin.

2. Type your text.
3. Repeat the above procedure for each column in your table.

Using Decimal Tabs while Typing

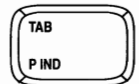

Decimal tab stops are a convenient feature unique to word processors. When you move the cursor there with **TAB**, the cursor remains fixed in that column, and each character that you type appears to the left of the tab stop. Once you type the decimal point, however, the point appears at the tab stop, and the cursor returns to normal operation. The primary use, of course, is to align columns of numbers with decimal points.

1. Press **TAB** to move the cursor to the next decimal tab stop to the right. A symbol → appears on the screen just before the new text cursor position to remind you that there is now a tab in the text.

NOTE:

If there is no tab stop to the right, the cursor moves to the right margin.

2. Type the number.
3. Repeat the above procedure for each column in your table.

NOTE:

*The cursor also returns to normal operation if you press **RETURN** or **TAB**.*

Inserting Tabs

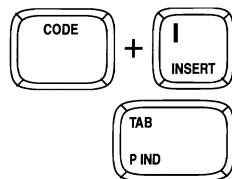

You may type your number or text first, and then align the columns with tabs and decimal tabs.

1. If the INS indicator off, press **CODE** + **INSERT** (**I**) to switch to the insert mode.

NOTE:

*If the insert mode is not on, **TAB** will just move to the next tab stop without aligning the text.*

2. Position the cursor on the beginning of the word that you want to align.
3. Press **TAB**. The word processor automatically adjusts the text to fit the margins and page length.

Removing Tabs

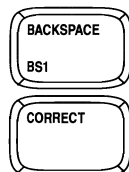

You may also remove a tab or decimal tab in order to change tabulated text to a paragraph.

1. Position the cursor just after the tab symbol → on the screen.
2. Press **BACKSPACE** or **CORRECT**. The word processor automatically adjusts the text to fit the margins and page length.

Line Indent

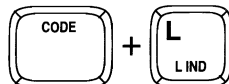

Pressing **CODE** + **L IND** (**L**) is the same as typing five permanent spaces. (See “Space vs. Permanent Space” on page 25.) The primary application is indenting the first line of a paragraph.

NOTE:

If the word processor is not in insert mode, these five spaces overwrite the five characters at the cursor location.

Line Indent

↓

This letter was typed on this new Word Processor to show you some of the many outstanding feats it can perform.

Paragraph Indent

The paragraph indent function may be considered as a temporary left margin.

Setting the Temporary Left Margin

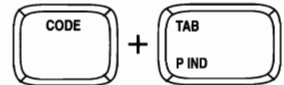

When you will need to indent text from the left margin, the paragraph indent feature indents text to a tab stop. When the indent is released, the cursor returns to the original left margin. (See "Setting Tabs" on page 43.)

1. Set the tabs you will need for any of the indented paragraphs.

NOTE:

If your document has multiple levels of paragraph indentation, it is a good idea to set all the tabs together at one point near the beginning.

2. If you have text, such as a section number, that you wish outside the indented block, type that data.
3. Press **CODE** + **P IND** as many times as necessary to move the cursor to the tab setting you want to be the new temporary margin. The word processor displays a \rightarrow symbol just before the new cursor position to remind you that the following text is indented.

NOTE:

*If you change your mind, use **BACKSPACE** or **CORRECT** to remove the paragraph indent symbol \rightarrow .*

Returning to the Original Left Margin

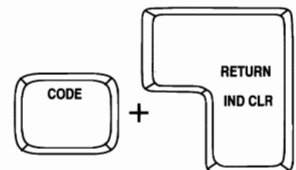

At the end of the indented paragraph, press **CODE** + **IND CLR** to restore the original left margin. The word processor marks the end of the indented paragraph with a \uparrow symbol to indicate that the paragraph indent mode has been exited.

NOTE:

To indent a paragraph after it has been typed, position the cursor on the first character of the paragraph to be indented and press **CODE** + **P IND** to reposition it at the tab position. At the end of the indented block, press **CODE** + **IND CLR** to restore the original left margin.

This letter was typed on this new Word Processor to show you some of the many outstanding feats it can perform.

In fact, you have seen some of these features in this letter: Centering has placed the title right in the center of the left and right margins, and

↑
Paragraph Indent

Centering

The centering function is used to center a line as characters are typed, or to center a line already typed. You may center text either between margins or between tab stops.

Centering Between Margins

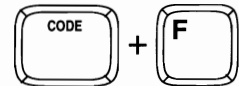

When you center between margins, the position of the cursor in the line does not matter.

1. Press **MENU** to display the menu.
2. Use **←** and **→** to select CTR/RMF, and press **RETURN** or **↓**.
 - **Accelerator:** Instead of (2), type "C".
3. Use **↑** and **↓** to select CENTERING and press **RETURN**. The cursor moves to the center point between your margins. The symbol for centering between margins **H** appears in the line. If the text has already been typed, it is automatically centered and you may skip step (4).
 - **Accelerator:** Instead of (3), type "C".
 - **Short cut:** Instead of (1), (2), and (3), press **CODE** + **F**.
4. Type the text.
5. Press **RETURN** to finish the centering operation.

Centering Between Margins

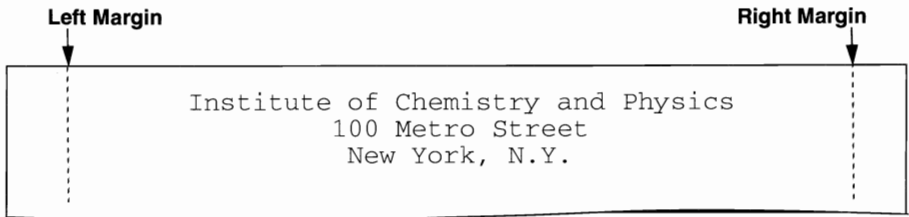

Centering Between Tabs

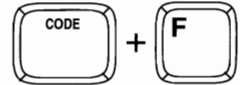

1. Press **TAB** as many times as necessary to reach the desired tab position (the position that will become the left end of the centering range).
2. Press **MENU** to display the menu.
3. Use **←** and **→** to select CTR/RMF, and press **RETURN** or **↓**.
 - **Accelerator:** Instead of (3), type "C".
4. Use **↑** and **↓** to select CENTERING and press **RETURN**. The cursor moves to the center point between the tab position where the cursor was in (1) and the next tab to the right – or the right margin if there are no more tabs set. A centering symbol **¶** appears on the line. If the text has already been typed, it is automatically centered and you may skip step (5).
 - **Accelerator:** Instead of (4), type "C".
 - **Short cut:** Instead of (2), (3), and (4), press **CODE** + **F**.
5. Type the text.
6. Press **RETURN** to finish the centering operation, or **TAB** to move to the next tab.

NOTES:

- Centering between a tab and the right margin is possible, but not between the left margin and a tab.
- Centering between a tab and a decimal tab is not possible.

Centering Between Tabs

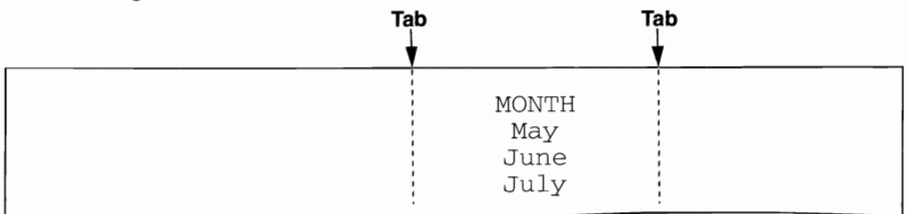

Undoing Centering

To exit the centering function, press **CANCEL** (you may also select CENTERING from the menu, or press **CODE** + **F**). To bring centered text flush with the left margin of the centering range, position the cursor just after the centering symbol **M** or **M̄** and press **BACKSPACE** or **CORRECT** to delete it.

Right Margin Flush

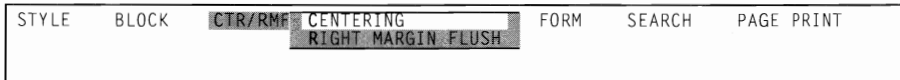
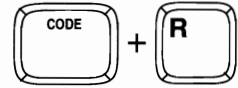

The right margin flush function is used to adjust a line automatically to end on the right margin.

1. If the text to be aligned flush with the right margin has not been typed yet, skip this step. If you want to align existing text, position the cursor on the first character of that text. If you want to align the whole line, position the cursor on the first character of the line.
2. Press **MENU** to display the menu.
3. Use **←** and **→** to select CTR/RMF, and press **RETURN** or **↓**.
 - **Accelerator:** Instead of (3), type "C".
4. Use **↑** and **↓** to select RIGHT MARGIN FLUSH and press **RETURN**. The cursor moves to the right margin. A right margin flush symbol **←** appears in the line. If the text has already been typed, it is automatically aligned flush with the right margin (any blank space at the end of the shifted line will be cut off) and you may skip step (5).
 - **Accelerator:** Instead of (4), type "R".
 - **Short cut:** Instead of (2), (3), and (4), press **CODE** + **R**.
5. Type the text. The cursor will not move, but the text that you type is scrolled to the left.
6. Press **RETURN** to finish the right margin flush operation and bring the cursor to the beginning of the next line.

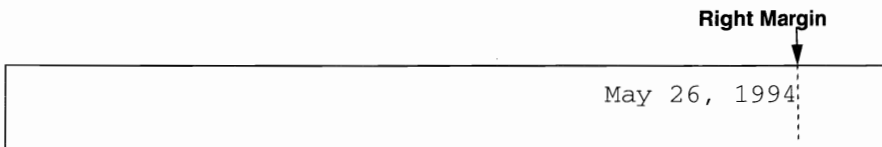

Undoing a Right Margin Flush Format

To exit the margin flush mode, press **CANCEL** (you may also select **RIGHT MARGIN FLUSH** from the menu, or press **CODE** + **R**). To undo an existing right margin flush format, delete the right margin flush symbol ← using **BACKSPACE** or **CORRECT**.

Automatic Justification

The justify function adjusts the spacing between words so that every complete line of text is aligned with both left and right margins.

Entering Justified Text

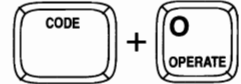

1. Press **CODE** + **OPERATE** (**O**) to turn the JST indicator on and start typing. When you type a space or a hyphen in the hot zone, the cursor moves to the next line and the current line is justified.
2. To resume normal typing, press **CODE** + **OPERATE** (**O**) again to turn the JST indicator off.

Justifying Existing Text

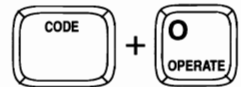

1. Position the cursor at the first paragraph that you want to justify.
2. Press **CODE** + **OPERATE** (**O**) to turn the JST indicator on. A ¶ symbol appears in the dead column of the first line of the paragraph and the text is automatically justified from this line down to the next ¶ symbol (if any exists) or down to the end of the document. If your document contains many ¶ symbols you will need to repeat these steps in order to justify the whole text.

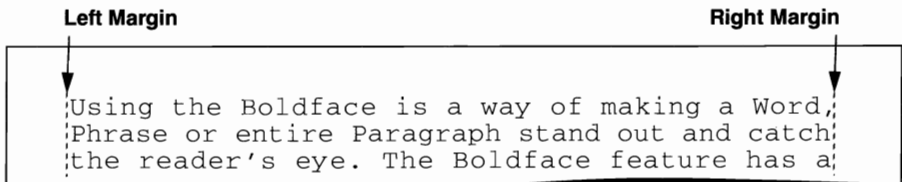

Text Emphasis

You can add special emphasis to text in your document with bold face type, underlining, and the expand function which automatically inserts a blank space between each character.

Bold Face Characters

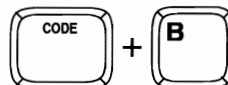

STYLE	BOLD	OFF	/RMF	SPELL	PHRASE	FORM	SEARCH	PAGE PRINT
	UNDERLINE	OFF						
	EXPAND	OFF						

1. If you want to turn the bold function on before typing, skip this step. If you want to change the type face of a portion of text already typed, position the cursor at the beginning of that portion.
2. Press **MENU** to display the menu.
3. Use **←** and **→** to select STYLE, and press **RETURN** or **↓**.
 - **Accelerator:** Instead of (3), type "S".
4. Use **↑** and **↓** to select BOLD.
5. Use **(SPACE BAR)** to turn the bold function ON.
 - **Accelerator:** Instead of (4) and (5), type "B".
6. Press **RETURN**. The BLD indicator is now on.
 - **Short cut:** Instead of (2), (3), (4), (5), and (6), press **CODE** + **B** to switch the bold function ON/OFF.
7. The text you now type or the text you select by moving the cursor right/down is displayed in bold. If you move the cursor past the desired position, move back to deselect. To move the cursor one line at a time, use **↑** and **↓**.
8. To return to normal typing, repeat steps (2), (3), (4), (5) and (6) to turn the bold function OFF, or press **CODE** + **B**.

NOTE:

To remove bold characters, position the cursor just after the last bold character, turn the bold function on, and move the cursor left/up. Turn the bold function off to remove bold emphasis.

Using the **Boldface** is a way of making a Word, Phrase or entire Paragraph stand out and catch the reader's eye. The **Boldface** feature has a

Underline

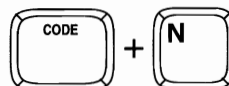

STYLE	BOLD	OFF	/RMF	SPELL	PHRASE	FORM	SEARCH	PAGE PRINT
	UNDERLINE	OFF						
	EXPAND	OFF						

1. If you want to turn the underline function on before typing, skip this step. If you want to underline a portion of text already typed, position the cursor at the beginning of that portion.
2. Press **MENU** to display the menu.
3. Use **←** and **→** to select STYLE, and press **RETURN** or **↓**.
 - **Accelerator:** *Instead of (3), type "S".*
4. Use **↑** and **↓** to select UNDERLINE.
5. Use **(SPACE BAR)** to select CNT (continuous underlining) or WRD (word underlining).
 - **Accelerator:** *Instead of (4) and (5), type "U".*
6. Press **RETURN**. The corresponding indicator is now on.
 - **Short cut:** *Instead of (2), (3), (4), (5), and (6), press **CODE** + **N** to switch the underline function CNT/WRD/OFF.*

NOTE:

If you select continuous underlining, all will be underlined, including blank spaces. With word underlining, blank spaces are not underlined.

7. The text you now type or the text you scan by moving the cursor right/down is underlined. If you move the cursor past the desired position, move back to remove the underline. To move the cursor one line at a time, use **↑** and **↓**.
8. To return to normal typing, repeat steps (2), (3), (4), (5) and (6) to turn the underline function off, or press **CODE** + **N**.

NOTE:

To remove underlining, position the cursor just after the last underlined character, select either option (CNT or WRD), and move the cursor left/up. Turn the underline function off to stop removing underlining.

Continuous Underline

Using the Underline is a way of making a Word, Phrase or entire Paragraph stand out and catch the reader's eye. The Underline feature has a

Word Underline

Using the Underline is a way of making a Word, Phrase or entire Paragraph stand out and catch the reader's eye. The Underline feature has a

Expand

STYLE	BOLD	OFF	/RMF	SPELL	PHRASE	FORM	SEARCH	PAGE PRINT
	UNDERLINE	OFF						
	EXPAND	OFF						

The expand function is available only while entering text. You cannot use it to reformat text that has been typed.

1. Press **MENU** to display the menu.
2. Use **←** and **→** to select STYLE, and press **RETURN** or **↓**.
 - **Accelerator:** Instead of (2), type "S".
3. Use **↑** and **↓** to select EXPAND.
4. Use **(SPACE BAR)** to turn the function ON.
 - **Accelerator:** Instead of (3) and (4), type "E".
5. Press **RETURN**. The EXP indicator is now on.
6. The text you now type is expanded – that is, a permanent space is automatically inserted after each text character (See also "Space vs. Permanent Space" on page 25.)
7. To return to normal typing, repeat steps (1), (2), (3), (4) and (5) to turn the expand function OFF.

NOTE:

The permanent spaces inserted with the expand function cannot be removed automatically. To undo the expand format, delete the permanent spaces one by one using **BACKSPACE** or **CORRECT**.

C O P Y

Expand

This letter was typed on this new Word Processor to show you some of the many outstanding feats it can perform.

Character Set

The display on this multilingual word processor supports all European languages written with the Roman alphabet, Greek and mathematical symbols. To type English text, all you need is the standard daisy wheel which comes with your word processor. There are other styles and pitches available. (See "Compatible Accessories" on page 150.)

However, if you have to type French text, or text requiring mathematical symbols, you need the corresponding Daisy Wheel(s) to have all the special characters correctly printed.

Switching the Keyboard

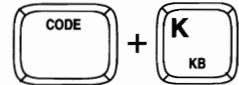

While typing your text with the WP application, you must select the desired keyboard in order to have the characters properly displayed on the screen. This is done by pressing **CODE** + **KB** (**K**). These keys switch the KB indicator through the following cycle:

KB: I → II → III → I

Keyboard Selection	Use
I (Standard)	For English text.
II (International)	For European languages using Roman alphabet.
III (Symbol)	For Greek letters and mathematical symbols.

NOTE:

For more details regarding the characters available in each keyboard, see "Character Keys" on page 128.

Changing the Daisy Wheel

The word processor will remember which keyboard selection was used to enter your text, and will prompt you to insert the corresponding daisy wheel when you print your document.

Horizontal Positioning

The display indicates the left margin and all other horizontal distances in terms of columns. On paper, however, the width of these columns depends on the selected pitch. This word processor supports three character widths:

Name	Character Spacing
Pica	10 characters per inch (cpi)
Elite	12 cpi
Micron	15 cpi

Screen Width vs. Paper Width

The distance between the left and right margins must be smaller than the paper width. Suppose your paper is 8.5 inches wide and you are using Pica pitch (10 cpi). You can fit a maximum of 85 characters per line. The distance between margins should therefore be smaller than 85 columns on the screen (check the COL indicator on the status line). The following table indicates the maximum distance between margins for letter-size paper:

Width	Maximum Characters Between Margins		
Letter Size	10 (Pica)	12 (Elite)	15 (Micron)
8.5 inch	85	102	127

Changing the Pitch

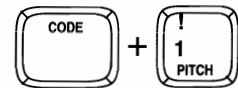

The pitch is automatically set to 10 when the power is turned on. Pressing **CODE** + **PITCH** will cycle the PITCH indicator through the following values:

PITCH: 10 → 12 → 15 → 10

When the pitch is changed, a format symbol ¶ appears in the dead column of the first line of that paragraph. The text is automatically reformatted down from the format symbol.

Vertical Layout

Just as the word processor formats your lines to fit within the desired left and right margins, it also automatically breaks your text up so that the maximum number of lines fit onto the page with the desired line spacings, top and bottom margins, and other formatting instructions that you specify.

Page Breaks

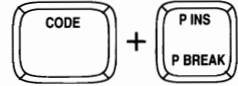

The text is always automatically formatted so that a maximum number of lines can fit on one page. Each time you want to start a new page, press **CODE** + **P BREAK**. A page break symbol ↓ will indicate that point, the cursor will move to the next line. The page count (P indicator) is incremented and the line count (L indicator) restarts from 1. If you change your mind, you can always erase this symbol (and eliminate the page break) with **BACKSPACE** or **CORRECT**.

Line Spacing

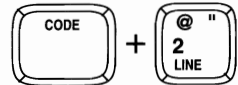

Pressing **CODE** + **LINE** cycles the L.SP indicator through the following values:

L.SP: 1.0 → 1.5 → 2.0 → 1.0

Line Spacing	Number of Lines per inch
1.0	6 lines/inch
1.5	4 lines/inch
2.0	3 lines/inch

To keep the maximum amount of text in view at all times, the word processor uses only single spacing on the screen. The number next to the L indicator, however, reflects the actual line count on paper. If you are at the top of your text with the cursor on line 1, for example, each time that you press ↓, the number that appears next to the L indicator depends on the line spacing as follows:

Line Spacing	Line Numbers
1.0	1, 2, 3, 4, 5, 6, 7,.....
1.5	1, 2 (2.5), 4, 5 (5.5), 7, 8 (8.5), 10,....
2.0	1, 3, 5, 7, 9, 11, 13,.....

Paper Size Setting

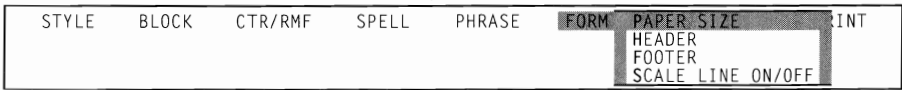

The paper size function allows you to specify all vertical layout parameters except line spacing (which you may change anywhere on the page). This feature is used to adjust your top and bottom margins.

1. Press **MENU** to display the menu.
2. Use **←** and **→** to select **FORM**, and press **RETURN** or **↓**.
 - **Accelerator:** Instead of (2), type "F".
3. Use **↑** and **↓** to select **PAPER SIZE** and press **RETURN**.
 - **Accelerator:** Instead of (3), type "P".
4. The PAPER SIZE screen shown below appears.



Settings	Definition
PAPER SIZE	The total length of the paper. The default, 66 lines, is suitable for letter-size paper (70 lines for A4-size paper).
TOP MARGIN	The distance between the top edge of the paper and the header (if present) or the top of the text (when there is no header). The default is 6 lines, which is one inch.
HEADER	An optional running header. (See "Header and Footer" on page 58.)
TOP SPACE	The distance between the header (if present) and the first line of the text. If you store a header, you must enter a number for this selection.
TEXT AREA	The number of lines reserved for the body of the text.
BOTTOM SPACE	The distance between the last line of the text and the footer (if present). If you store a footer, you must enter a number for this selection.
FOOTER	An optional running footer. (See "Header and Footer" on page 58.)
BOTTOM MARGIN	The distance between the footer (if present) or the last line of the text and the bottom edge of the paper. The default is 6 lines, which is one inch.

NOTE:

The text cursor cycles through only five of the eight fields on the screen. HEADER, FOOTER and TEXT AREA are automatically updated by the word processor. The numbers for HEADER and FOOTER are automatically set to 1 line if you store a header or footer, or 0 lines if there is no header or footer. The length of the TEXT AREA is defined as the PAPER SIZE less the lines reserved for TOP MARGIN, HEADER, TOP SPACE, BOTTOM SPACE, FOOTER, and BOTTOM MARGIN.

5. Press **←** or **↓** until you reach the parameter that you wish to change.
6. Type the new value and press **→** or **↑** to move to the next parameter that you want to change. Notice how the text area value will change to accommodate your selections.
7. When all the desired changes have been entered, press **RETURN**. Alternatively, press **CANCEL** to return without saving the new settings.

NOTE:

Your text will be divided into pages automatically according to the settings for the paper size. If you wish to begin a new page prior to reaching the line set by the paper size setting, press **CODE** + **P BREAK**.

Header and Footer

STYLE	BLOCK	CTR/RMF	SPELL	PHRASE	FORM	PAPER SIZE	INT
						HEADER	
						FOOTER	
						SCALE LINE ON/OFF	

STYLE	BLOCK	CTR/RMF	SPELL	PHRASE	FORM	PAPER SIZE	INT
						HEADER	
						FOOTER	
						SCALE LINE ON/OFF	

A header is a title line and/or page number that will be automatically printed at the top of every page. A footer is a similar line at the bottom of the page.

1. Press **MENU** to display the menu.
2. Use **←** and **→** to select FORM, and press **RETURN** or **↓**.
 - **Accelerator:** Instead of (2), type "F".
3. Use **↑** and **↓** to select HEADER or FOOTER, and press **RETURN**.
 - **Accelerator:** Instead of (3), type "H" or "F".
4. Type the header or footer and press **RETURN**. The text of the header or footer cannot exceed one line. It will disappear from the screen when **RETURN** is pressed, but will print on the line determined by the paper size setting when the text is printed. Pressing **CANCEL** at this step returns the system to the normal mode without entering the header or footer in memory.

NOTES:

- As mentioned before, entering a header or footer automatically updates the setting of the paper size screen.

- You may have page numbering automatically included in the header or footer. If you type a number enclosed in double quotes, this number will be incremented for each page when printed. (The double quotes are not printed.) Begin with number 1 or with a different number if needed. This is useful if, for instance your document is the third chapter of a book. If chapter 3 starts at page 23, enter "23". Any number up to four digits in length (9999) is accepted.
- Example of header and footer with page numbering:

MONTHLY REPORT MAY 1994 - page "10"

- Printing effects (**BOLD** and UNDERLINE) can also be used with a header and footer. You may also center the header or footer or make it flush to the right margin.

Header

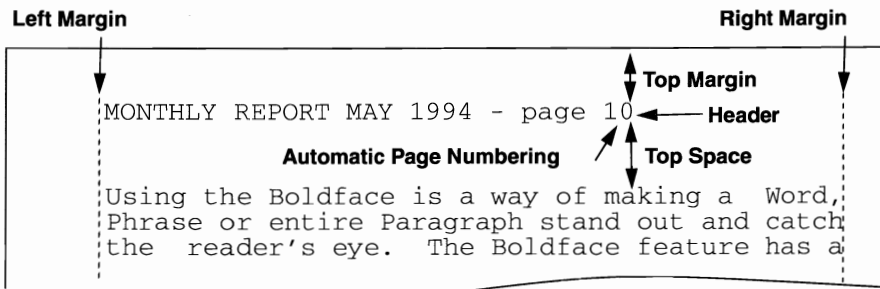

Footer

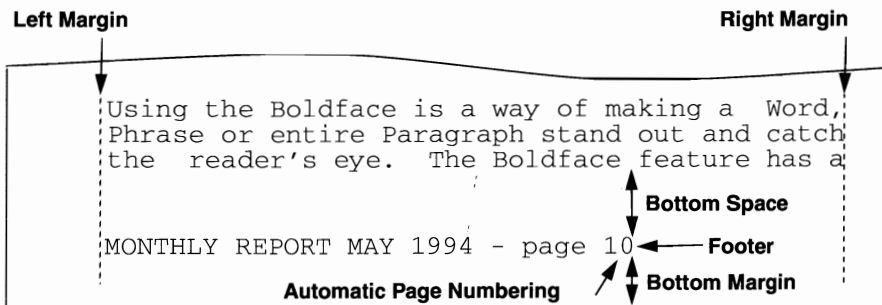

File Operation

The word processor stores each document in a separate “file” on a diskette and under an individual “file name” of up to eight characters that you choose when you store the document for the first time.

You are allowed to save your document at any moment during editing. Once your document is saved, you may start working with another document, or switch the word processor off. The next time you switch the word processor on, you may retrieve your document to complete editing. You may also decide to print a document that has been completed and previously saved, or the document you are working on.

This word processor also includes several File Utility functions such as file copy, delete, and rename that allow for easy maintenance of your text files.

Viewing the WP INDEX Screen



To view the list of your WP files on a particular diskette, switch from the WRITE/EDIT screen to the WP INDEX screen, insert that diskette, and press **FILE**.

The word processor assumes that you might wish to save the data that is currently displayed on the WRITE/EDIT screen. (For details, see “Saving a File” on page 61.)

NOTE:

If you are using a brand new diskette or a diskette that has been used with another word processor or computer, please read “Initializing New Diskettes” on page 14.

The WP INDEX screen lists all the WP files on the current diskette. Example:

<< WP INDEX >>		REMAIN:XXX.XK		
*NEWFILE	TEXT1	(XX.X)	TEXT2	(XX.X)
TEXT3 (XX.X)	TEXT4	(XX.X)	TEXT5	(XX.X)
Select a file and press RETURN. Press CANCEL to display MAIN MENU.				

*NEWFILE is not a file stored on the diskette. This is an empty file that allows you to start from scratch.

The numbers displayed in parentheses at the right of the file names indicate the size of the files (in kilobytes).

The number following the indicator REMAIN shows the remaining space on the diskette.

A file name can be selected by moving the block cursor (reverse display of the file name) with the cursor keys. If you have more files on the diskette than the amount that can be displayed on the screen, **↑** and **↓** will scroll the display.

Saving a File

When you have completed typing and formatting a document, you will want to save it on the diskette.

Although the word processor allows you to type and print documents without saving them to diskette, saving is a good idea. You might, for example, find a mistake or change your mind just as you put the letter in the envelope. You can always delete unwanted documents later if you need more room. (See "Deleting a File" on page 71.)

Saving a New File



After creating a new file (the file name that appears on the upper-left corner of the screen is *NEWFILE), you have the options of saving or abandoning the file.

1. Press **FILE** to display the following prompt on the message line:

Save file? Press RETURN to save, CORRECT to abandon.

2. Press **RETURN** if you want to save the file, or **CORRECT** if the file is not worth saving.

WARNING:

*If you press **CORRECT**, the word processor switches to the WP INDEX screen without saving, and your work is lost.*

NOTE:

*Press **CANCEL** instead of **RETURN** or **CORRECT** to abandon saving and return to the WRITE/EDIT screen.*

3. If you have pressed **RETURN**, the word processor asks you to input a file name:

Type filename and press RETURN.

FILENAME: █

4. Type the file name (See "Entering a File Name" on page 63) and press **RETURN**. The word processor returns to the WP INDEX screen and you can confirm that the new file appears in the list.

Saving an Edited file

After editing an old file (the file name that appears on the upper-left corner of the screen is not *NEWFILE), you have the options of replacing the old version on the diskette with the new version (overwriting), abandoning the new version, or saving the new version under a separate file name.

1. After editing the file, press **FILE** to display the following prompt:

Save file? Press RETURN to save, CORRECT to abandon.

NOTE:

If **FILE** is pressed without editing the document, the word processor proceeds directly to the WP INDEX screen without prompting you to save the file.

2. Press **RETURN** if you want to save the file, or **CORRECT** if you do not want to save the new version of the file.

WARNING:

If you press **CORRECT**, the word processor switches to the WP INDEX screen, and your last editing is lost. The old version of the file will remain untouched on the diskette.

NOTE:

Press **CANCEL** instead of **RETURN** or **CORRECT** to abandon saving and return to the WRITE/EDIT screen.

3. If you have pressed **RETURN**, the word processor asks you to enter a new file name:

Type filename and press RETURN.

FILENAME: XXXXXXXX

4. If you want to keep both the old and new version of your file, type a new file name and press **RETURN**. The current version is saved under this new file name. If you want the current version of the file to replace the old one, press **RETURN** without modifying the file name. This message will appear:

Filename already exists. Type new filename and press RETURN.

FILENAME: XXXXXXXX

NOTE:

The above message also appears if you have mistakenly typed a file name already in use.

5. Press **RETURN** to overwrite (update) the old file. You can also type a new file name and press **RETURN** if you decide that you want to keep the old file.

Entering a File Name

When you are prompted to enter a file name, the WP INDEX screen shows only a list of the text files already saved on the diskette. The list of text files is displayed so that you can easily avoid entering a file name that is already used for another file. When typing a file name, please keep the following rules in mind:

1. A file name is made of up to eight characters. A beep sounds if you try to input more.
2. The word processor accepts only the following characters in file names: upper and lower case letters of the alphabet (A-Z and a-z), the digits (0 to 9), and the hyphen (-). All others are refused and trigger a beep.
3. The word processor distinguishes between upper and lower case letters. This means that you can have a file called "Letter", and a file called "letter" on the same diskette.
4. To correct an error, use **BACKSPACE**, **CORRECT**, or **WORD OUT** to erase the preceding letter or use **←** and **→** to move the text cursor back over the name and retype.
5. Check the list of file names to avoid typing a file name which already exists. If you have more files than can be displayed on the screen, use **↑** and **↓** to scroll the file names on the WP INDEX when typing a new file name.

Automatic Save Function

This word processor is equipped with an Automatic Save function that prevents the loss of a document if the power is accidentally turned off before you save the file.

When you have created a file and input up to 2,000 key strokes of data, your word processor will automatically create an AUTO SAVE FILE, which will be updated every 2,000 strokes. Thus, in the event of an accidental power outage, all but the last input of your file (those after the last updating of the AUTO SAVE FILE) are safe.

When you turn the power on with a diskette inserted in the drive, the system automatically searches for the AUTO SAVE FILE. If such a file exists, the system recognizes that a power loss occurred during the last session with that diskette, and the following message telling you how to recover the lost file will appear:

POWER FAILURE...recover AUTO SAVE FILE? Press RETURN(yes) or CANCEL(no).

Press **RETURN** to recover the contents of the file, or **CANCEL** to delete the AUTO SAVE FILE from the diskette.

When you save a file, the AUTO SAVE FILE is deleted so that the next time you turn the power on, the AUTO SAVE FILE will not be found, and the above message will not appear.

Returning to the Main Menu

EXIT COPY DELETE RENAME DISK COPY DISK DELETE PROTECT ON/OFF PRINT

1. Press **MENU** to display the function menu.
 2. Use **←** and **→** to select EXIT and press **RETURN**.
- **Accelerator:** Instead of (2), type "E".
 - **Short cut:** Instead of (1) and (2), press **CANCEL**.

Retrieving a File

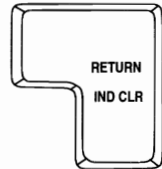

To retrieve an old file in order to complete typing or resume editing, you must first display the WP INDEX screen. The WP INDEX screen always appears when you select the WP application from the MAIN MENU. That screen also appears after you save a WP file, so that you can continue working with another file.

Once the WP INDEX screen is displayed, select the name of the file that you want to retrieve by moving the block cursor with **←**, **→**, **↑**, and **↓** to its name on the screen and pressing **RETURN**. The file will be loaded from the diskette into the word processor's memory and the beginning of the document will be displayed on the WRITE/EDIT screen.

Printing a Document

You may either print the page currently displayed on the WRITE/EDIT screen or print an entire file after saving it.

Starting Page Print

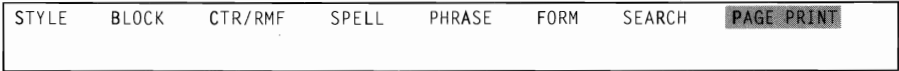
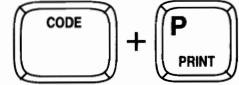

When you print a single page from the WRITE/EDIT screen, all settings like header, footer, and keyboard changes are effective. The stop symbols, however, do not cause printing to stop, but instead are printed as blank spaces.

1. Insert a sheet of paper. (See "Inserting Paper" on page 6.)
2. Position the cursor on the page that you want to print.
3. Press **MENU** to display the menu.
4. Use **←** and **→** to select PAGE PRINT, and press **RETURN**.
 - **Accelerator:** Instead of (4), type "P".
 - **Short cut:** Instead of steps (3) and (4), press **CODE** + **PRINT** (**P**).
5. For next operation, see page 67.

Starting File Print

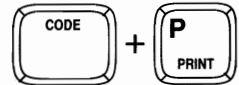

If you wish to print the entire document, you must use the WP INDEX screen.

1. Move the block cursor to the file that you want to print.
2. Press **MENU** to display the menu.
3. Use **←** and **→** to select PRINT, and press **RETURN**. The print menu screen shown below appears.
 - **Accelerator:** Instead of (3), type "P".
 - **Short cut:** Instead of steps (2) and (3), press **CODE** + **PRINT** (**P**).





STARTING PAGE	█	HEADER PRINT	YES	MERGE PRINT	NO
ENDING PAGE	999	FOOTER PRINT	YES	DOUBLE COLUMNS	NO
NUMBER OF COPIES	1	PAUSE FOR KB CHANGE	YES	SPACE BET. COLUMNS	5
Type number, insert paper, press RETURN to start printing.					

The definition of each setting is explained in the next table.

Option	Definition
STARTING PAGE	The page number of the file on which printing is to start. The setting must be greater than zero and less than 1000. The default is 1 (starting from the first page).
ENDING PAGE	The page number of the file on which printing is to end. Must not be lower than the STARTING PAGE number. If the number is higher than the total number of pages, printing stops after the last page. The default is 999.
NUMBER OF COPIES	The number of copies you want to print. Must be greater than zero and less than 100. The default is 1 (the pages are printed once).
HEADER PRINT	Use (SPACE BAR) to toggle between YES and NO. If YES, any existing header will be printed on each page. If NO, no header will be printed, even if you have entered one.
FOOTER PRINT	Use (SPACE BAR) to toggle between YES and NO. If YES, any existing footer will be printed on each page. If NO, no footer will be printed, even if you have entered one.
PAUSE FOR KB CHANGE	Use (SPACE BAR) to toggle between YES and NO. If YES, pauses will be made for changing the daisy wheel when necessary. If NO, all pages will be printed out using the same keyboard that is used for the first character to be printed. However, if the character pitch had been changed during the WRITE/EDIT mode, pauses will be made for changing the daisy wheel even if NO is selected.
MERGE PRINT	This should be left as NO when printing ordinary document files. (See "Merge Printing" on page 78.)
DOUBLE COLUMNS	This should be left as NO when printing ordinary document files. (See "Double Column Printing" on page 75.)
SPACE BET. COLUMNS	This is used together with the above double columns printing and should be ignored when printing ordinary document files. (See "Double Column Printing" on page 75.)

NOTE:

The default values for STARTING PAGE, ENDING PAGE, and NUMBER OF COPIES are displayed each time the print menu screen is called up.

4. Move the cursor with  and  to any values you would like to change, and change using  for YES/NO setting, or by typing the desired value for the other options.
5. Insert a sheet of paper and press .

NOTES:

- Press  at any time to terminate selection and return to the WP INDEX screen.
- If there is a wrong setting, the following message appears and you have to correct it to the right setting.

Incorrect setting.

NOTE:

An error will occur if the setting for STARTING PAGE is greater than the last page of the document.

Incorrect page number. Press CANCEL to exit.

6. If this is the first time you are printing the file, or you have previously printed a file using a different pitch, you will be prompted to install the proper daisy wheel to match the pitch setting selected. Insert the correct wheel, if necessary, and press . As soon as printing starts, the following message is displayed:

Printing. Press SPACE to pause.

Pausing/Resuming Printing

Sometimes you may wish to temporarily interrupt printing – to adjust the paper position, for example.

1. Press  to stop the printer. A message indicating that the printer is paused will be displayed.

Printing paused. Press SPACE to continue.

2. Press  to restart the printer. The above message reappears:

Printing. Press SPACE to pause.

NOTES:

- Printing in progress can be terminated by pressing .

- When printing is completed (or cancelled with the **CANCEL** key), the system returns to the WRITE/EDIT screen (page printing) or to the WP INDEX screen (file printing).

Daisy Wheel Changes

Each time the word processor finds a pitch change in the file, and, if you have set the PAUSE FOR KB CHANGE option to YES, each time the word processor finds a keyboard change, printing is interrupted and a message similar to the following will appear:

Change to KB:II 12 wheel and press RETURN.

This means that an international daisy wheel of pitch 12 is required at this point. Change the wheel and press **RETURN** to resume printing.

NOTE:

If PAUSE FOR KB CHANGE is set to NO in the print menu screen, printing will stop for pitch changes, but not for keyboard changes.

Stop Symbols

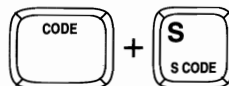

Stop symbols **⌘** can be placed in your file to instruct the printing to stop at a particular point. When printing stops, your word processor automatically switches to the typewriter application and you are able to insert text at that position. This feature is primarily used for applications using form letters with minor changes. For example, if you need to send out two identical letters and the only information that is different is the name and address of the person the letter is being sent to, proceed as follows:

1. When creating the letter, press **CODE** + **S CODE** (**S**) to insert a stop code at the point where the name and address appears. During printing, you will be able to manually type in the appropriate name and address when the printing stops.
2. Save your file and start file printing as explained above.
3. When the word processor finds a stop code, printing is interrupted and the following message appears:

Stop code. Type text and press PRINT to continue.

4. Type your text (name and address in our example). This will not be stored in memory. The remainder of the file will, however, be reformatted to accommodate the inserted text.
5. Press **CODE** + **PRINT** (**P**) to resume printing.

NOTES:

- *Stop codes are ignored and replaced as a space during page printing. They are only effective during file printing through the WP INDEX screen. You may print the file as many times as required, each time inserting different information.*
- *When printing has temporarily stopped after a stop code has been encountered, the printing mode may be canceled entirely by pressing **CANCEL**, at which time the display will return to the WP INDEX screen.*
- *When a stop code for direct typing is encountered at the end of the text area defined in the P SIZE setting (54 lines is default) and additional typing will exceed this setting, a beep will sound and the word processor will go into PAGE END status. The following message will appear on the display:*

Page end. Press CORRECT to type one more line.

NOTE:

*In order to type one more line, press **CORRECT** and begin typing. Or press **PINS** to change to a new page.*

Diskette Utility Functions

To help you keep your document files in order, there are utility functions for discarding out-of-date files and making copies. (See also "Initializing New Diskettes" on page 14.)

NOTES:

- The following descriptions all assume that you have saved your current document and are already at the WP INDEX screen. (See "Saving a File" on page 61.)
- The functions that are available in the WP INDEX screen are displayed when you press **MENU**.

Copying a File

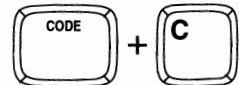

```
EXIT COPY DELETE RENAME DISK COPY DISK DELETE PROTECT ON/OFF PRINT
```

You may wish to edit a file and keep both the old and new version on the diskette. (Make a copy of the file before editing it). You can also copy important files onto a different diskette to back up your work.

1. Move the block cursor to the file that you want to copy.
2. Press **MENU** to display the menu.
3. Use **←** and **→** to select COPY, and press **RETURN**. The following message appears:

```
Insert destination disk and press RETURN.
```

- **Accelerator:** Instead of (3), type "C".
 - **Short cut:** Instead of (2) and (3), press **CODE** + **C**.
4. You may create this copy on the same diskette or on a different diskette. To copy on to the same diskette, just press **RETURN**. If you want to copy the file to another diskette, remove the source (original) diskette and insert the destination diskette and press **RETURN**. The following message appears:

```
Type filename and press RETURN.
```

```
FILENAME: XXXXXXXX
```

5. Input the new file name and press **RETURN**. If you copy the file on a different diskette, you can use the same file name. The following message is displayed during the copy operation and disappears after completion. The system then returns to the WP INDEX screen, with the block cursor on *NEWFILE.

Copying the file...please wait.

NOTE:

If the specified new file name already exists on the inserted diskette when you press **RETURN** in step (5), the following message appears:

Filename already exists. Type new filename and press RETURN.

FILENAME: XXXXXXXX

NOTE:

To avoid overwriting the old file, type a new file name and press **RETURN**, or press **RETURN** without changing the file name to overwrite the old file.

Deleting a File

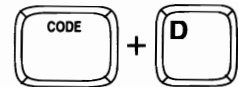

EXIT COPY **DELETE** RENAME DISK COPY DISK DELETE PROTECT ON/OFF PRINT

File deletion is useful when the diskette is full and saving cannot be carried out. You may delete unwanted files to make room for your new document.

1. Move the block cursor to the file that you want to delete.
2. Press **MENU** to display the menu.
3. Use **←** and **→** to select **DELETE**, and press **RETURN**. The following message appears:

Delete? Press Y(yes) or N(no).

- **Accelerator:** Instead of (3), type "D".
 - **Short cut:** Instead of (2) and (3), press **CODE** + **D**.
4. Press **Y** to delete the file. The file is deleted and the block cursor moves back to the WP INDEX screen. If you press **N**, the message disappears and the system goes back to the WP INDEX screen without deleting the file. The cursor will be on the file which was to have been deleted.

Renaming a File

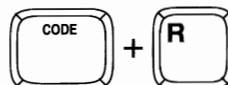

EXIT COPY DELETE **RENAME** DISK COPY DISK DELETE PROTECT ON/OFF PRINT

To change the name of a file, follow these steps.

1. Move the block cursor to the file that you want to rename.
2. Press **MENU** to display the menu.
3. Use **←** and **→** to select RENAME, and press **RETURN**. The following message appears:

Type filename and press RETURN.

FILENAME: XXXXXXXX

- **Accelerator:** Instead of (3), type "R".
- **Short cut:** Instead of (2) and (3), press **CODE** + **R**.
- 4. Input the new file name and press **RETURN**.
- **If the specified new file name already exists when you press **RETURN** in step (4), the following message appears:**

Filename already exists. Type new filename and press RETURN.

FILENAME: XXXXXXXX

- **Type a new file name and press **RETURN**.**

NOTE:

Pressing **CANCEL** while a message is displayed cancels the operation and returns the system to the WP INDEX screen.

Disk Copy

EXIT COPY DELETE RENAME **DISK COPY** DISK DELETE PROTECT ON/OFF PRINT

This function allows you to copy all files contained on a diskette to another diskette (back up copy).

WARNINGS:

- **The Disk Copy function erases the Temporary file from the memory.**
- **Copying an entire diskette to another destroys any data that may be on the destination diskette. Check the destination diskette before starting. Be sure your destination diskette has been initialized.**

1. Press **MENU** to display the menu.
2. Use **←** and **→** to select DISK COPY, and press **RETURN**. The following message appears:

Insert source disk and press RETURN.

- **Accelerator:** *Instead of (2), type "O".*
3. Insert the source (original) diskette and press **RETURN**. The word processor will start reading files from the source diskette. Since the memory space is limited, the word processor may not be able to read all files in one step. After a while, this message will appear:

Insert destination disk and press RETURN.

4. Insert the destination diskette and press **RETURN**. The word processor will transfer the files that have been read from the source diskette onto the destination diskette. If all the files of the source diskette have not been transferred yet, the word processor will ask you to re-insert the source diskette. repeat steps (2) and (3) until all files have been transferred to the destination diskette. You may need to swap these diskettes a number of times before all of the files are copied to the destination diskette.

NOTE:

The word processor "knows" which diskette is the source diskette and which one is the destination diskette. If you mistakenly insert a wrong diskette, one of these messages will appear:

Incorrect disk. Insert destination disk and press RETURN.

Incorrect disk. Insert source disk and press RETURN.

NOTE:

*You may press **CANCEL** at any time (except during diskette access) to cancel the operation.*

When copying is complete, the INDEX screen reappears.

Deleting All Files

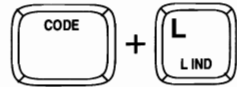

EXIT COPY DELETE RENAME DISK COPY **DISK DELETE** PROTECT ON/OFF PRINT

1. Press **MENU** to display the menu.
2. Use **←** and **→** to select DISK DELETE, and press **RETURN**. The following message appears:

Delete all files on this disk? Press Y(yes) or N(no).

- **Accelerator:** Instead of (2), type "L".
 - **Short cut:** Instead of (1) and (2), press **CODE** + **L**.
3. If you press **Y**, all the files on the inserted diskette are deleted, the message disappears, and the block cursor moves to *NEWFILE. Pressing **N** interrupts deleting and returns the system to the WP INDEX screen.

NOTE:

The disk delete function is to delete all of the files on the diskette. This includes all WP files, MERGE files, ABBREVIATED PHRASE files, and USER DICTIONARY files. Be sure that there are no files that you want to keep before you start this function.

Diskette Write-Protect

The disk drive does not recognize the switch on the diskette for write-protection of the diskette.

EXIT COPY DELETE RENAME DISK COPY DISK DELETE **PROTECT ON/OFF** PRINT

1. Press **MENU** to display the menu.
2. Use **←** and **→** to select PROTECT ON/OFF, and press **RETURN**.

The write-protect mode is turned on and the diskette is protected from accidental erasing.

NOTE:

- The remaining diskette free space will be displayed in reverse image when the diskette is "WRITE-PROTECT ON".
 - The remaining diskette free space will be displayed in normal image when the diskette is "WRITE-PROTECT OFF".
3. To turn WRITE-PROTECT OFF select PROTECT ON/OFF from the menu and press RETURN.

Advanced Functions

This section deals with the most advanced functions available on this word processor with the WP application. These functions will enable you to further improve the overall quality of your documents and eliminate most of the mechanical tasks.

Double column printing is used to automatically print a document in two columns. The merge function is used to automatically print many copies of a document, each copy including individual changes such as names and addresses.

Double Column Printing

This function allows you to print your text in magazine style, with two columns across the page. A page on the screen will be printed as a column on paper. In other words, two pages will be printed on a single sheet of paper, the first page as the left column and the second page as the right column.

When formatting your document for double column printing, reduce the distance between margins so that both columns and the space between columns can fit on the paper. The margins for the document should be set for one column. Use 12 or 15 pitch in order to fit more text on a line.

NOTES:

- Double column printing does not work with merge printing. Merge symbols as well as stop symbols are ignored during double column printing, and replaced with blank spaces.
 - To ensure proper column alignment, the document must not contain any margin, pitch, or line-spacing changes. It may, however, contain any number of tab stop changes.
1. Proceed as you would to print a text file in standard format. (See "Starting File Print" on page 65.)
 2. When the print menu screen appears, set the DOUBLE COLUMNS to YES. If necessary, set the SPACE BET(ween) COLUMNS (the default is five blank spaces and the available range is from 1 to 50). At this point, you may also change other settings on the menu as well, but you must not set the MERGE PRINT option to YES.
 3. Press **RETURN** to start printing.

Right Margin Setting for Double Column Printing

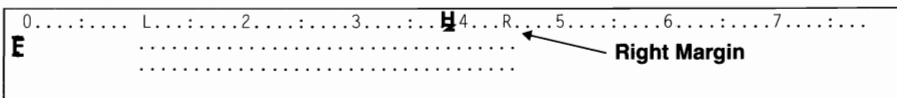

Double Column Printout

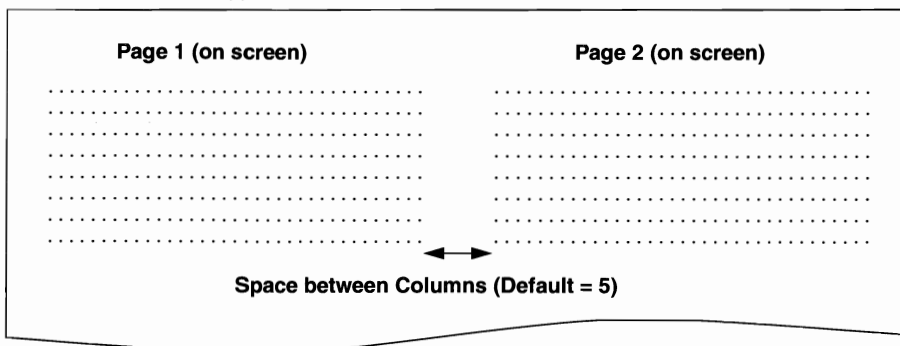

Data Merge

The data merge function is useful when a similar letter is to be sent to numerous addresses, each letter to be typed with a different name and address and different contents. To save you from having to recall, edit, and print the same letter over and over, the merge file function does the job automatically. The following steps summarize the use of this function:

1. To use the data merge function, you must first create a file containing the data to be inserted in the letters (the Merge file). For details, see "Mail Merge" on page 117. The data to be inserted into a single letter is called a record. A record is made of different labels (label 1, label 2, label 3, etc.) that correspond to the different pieces of information you need to insert in a single letter (name, address, etc.). You must organize your Merge file logically: the same label of each record must contain the same type of information. For example, label 1 will contain a name, label 2 an address, label 3 a phone number, etc.
2. Next, you must create a Word Processing file containing the text that will be common to all letters (the master document). Wherever a piece of variable information has to be inserted in that text, you insert a "merge symbol" and input a label number.
3. When you print the master document, the text is printed until a merge symbol is encountered. At that point, the word processor compares the number that you have input with the merge symbol, and automatically replaces the merge symbol with the data contained in the corresponding label of the first record. When the whole document is printed, the word processor checks the Merge file to see if there are more records. If there are no more records, merge printing is completed. Otherwise printing of the master document starts again, and this time, the next record of the Merge file is used. The process is repeated until all records of the Merge file have been used.

Creating the Merge File

To use the Data Merge function, you must first create a Merge file, which is a file containing the names, addresses or other data to be inserted into the document. You create that file using the Mail Merge application. For details, see "Mail Merge" on page 117.

Also be sure to remember which label numbers (columns) in the Merge file correspond to the different pieces of information you want to insert.

Creating a Document with Merge Symbols

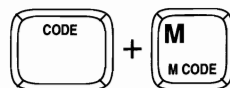

Your next step is to create the master document with the Word Processing application.

1. Begin typing your document.
2. Once you reach a point in your document where data from the Merge file needs to be inserted, press **CODE** + **M CODE** (**M**). A merge symbol **M** appears in the document. The MRG: indicator appears and the cursor rests to its right waiting for your input. If the Scale was displayed, the Status Line is automatically displayed. The following message appears:

Type number and press RETURN.

3. Type the number of the label that you need at that position of the document. Using the above example, type "1" if you need a name, "2" if you need an address, or "3" if you need a phone number.
4. To resume normal operation, press **RETURN**. The cursor returns to the text area.
5. Continue typing your document, inserting merge symbols wherever you need variable data from the Merge file.

NOTES:

- A mistake when inserting a merge symbol can be corrected by pressing **CORRECT**, and retyping the correct number.
 - A merge symbol is not available in the Centering or the Right Margin Flush function.
6. Press **FILE** to finish the master document.

Merge Printing

When copies of the same letter must be sent to a number of people, the merge printing function extracts the different data, such as addresses and salutations, from the Merge file you want to use and incorporates it into the master letter. It then prints as many different copies as there are lines of data (records) with an asterisk in the Merge file. Proceed as follows:

1. Refer to "Starting File Print" on page 65 to print the master document.
2. When the print menu screen appears, set the MERGE PRINT option to YES. (See "Starting File Print" on page 65.) At this point, you may also change other settings on the menu as well. Pressing **RETURN** to exit the print menu screen when the MERGE PRINT option has been set to YES will display the MAIL MERGE INDEX screen, listing all the Merge files on the current diskette. If the Merge file you want to use is not on the current diskette, insert the correct diskette.

```

<< MERGE INDEX >>          PRINT FILE:XXXXXXXX          REMAIN:XXX.XK
ADDRESS1.MRG (XX.X)      ADDRESS2.MRG (XX.X)      ADDRESS3.MRG (XX.X)
ADDRESS4.MRG (XX.X)
Select a file and press RETURN to start printing.
  
```

3. Select the Merge file that you want to use with the master document and press **RETURN** to start printing. You may also press **CANCEL** at this point to return the system to the WP INDEX screen. All the functions available during normal file printing are also available during merge printing. (See "Printing a Document" on page 65.)

NOTES:

- If there is no data in the Merge file corresponding to a merge symbol in the text file, a single space will be printed.
- Printing of merge data is done according to the mode (NORMAL, BOLD, UNDERLINE, etc.) in effect when the merge symbol was entered.

Abbreviated Phrases

Increasing Your Typing Speed

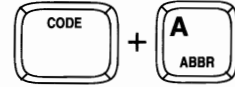

The abbreviated phrase function is provided to help you increase your typing speed when you have to frequently type long strings of words (“phrases”). You may store the phrases in the abbreviated phrase memory, along with a short abbreviation (the “name” of the phrase). For instance, you may store the phrase “United States of America” together with the name “USA”. Once this has been done, all you have to do to enter “United States of America” in your document is to type “USA” and press **CODE** + **ABBR** (**A**). “USA” will automatically be replaced with “United States of America”. If you type a name that does not exist in the abbreviated phrase memory, and press **CODE** + **ABBR** (**A**), you will hear a beep.

The abbreviated phrase memory can store a maximum of 30 phrases and names. Each phrase can consist of up to 67 characters, while a name is limited to 8 characters. The total amount of data in the abbreviated phrase memory may not exceed 1,000 characters.

The abbreviated phrase memory can be saved on diskette and, of course, retrieved from the diskette. You may create as many abbreviated phrase files as you want, but you may have only one abbreviated phrase file on a diskette.

Understanding the Abbreviated Phrase Memory

The abbreviated phrase memory is stored in the word processor for as long as the unit remains on. If you have created phrases and would like to use these phrases in other files you will be creating later on, you will need to **SAVE** this phrase memory onto a diskette. (See “Saving the Abbreviated Phrase Memory” on page 82.) Later, when you want to use the phrases that are stored on a diskette, you may **LOAD** the file into the memory of the unit. (See “Loading an Abbreviated Phrase File” on page 82.)

NOTES:

- Each diskette can hold only one abbreviated phrase file. If you save an abbreviated phrase memory onto a diskette that already contains an abbreviated phrase file, that file will be overwritten by the new abbreviated phrase file.
- The memory of the word processor can hold only one abbreviated phrase memory. If you create an abbreviated phrase memory, and then load an abbreviated phrase file from a diskette, the abbreviated phrase memory will be overwritten by the loaded file.

Abbreviated Phrase Maintenance

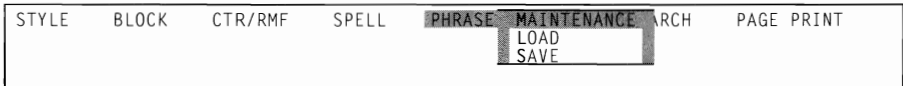

This section explains how to input and edit data in the abbreviated phrase memory.

1. Press **MENU** to display the function menu.
2. Use **←** and **→** to select PHRASE, then press **↓** or **RETURN** to display the sub-menu.
 - **Accelerator:** *Instead of (2), type "A".*
3. Use **↑** and **↓** to select MAINTENANCE and press **RETURN**. The following display appears:

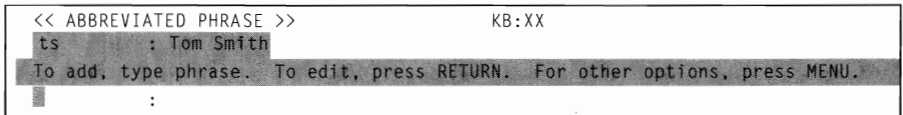

- **Accelerator:** *Instead of (3), type "M".*
4. To enter new data, type the name, press **TAB** to switch to the phrase area, then type the phrase and press **RETURN**.

NOTE:

Use only letters, numbers and periods for the name.

5. To edit an existing line of data, select the line and press **RETURN**. The data will appear in the input area. Edit the data, then press **RETURN** again.
6. To return to the WP screen and resume typing, press **FILE** or press **MENU** to display the menu and select EXIT.

NOTES:

- *If you have added phrases, you will need to save the abbreviated phrase memory onto the diskette.*
- *To recall a phrase into the WP text file, type the assigned name and press **CODE** + **ABBR** (**A**).*

Using the Function Menu for Other Options

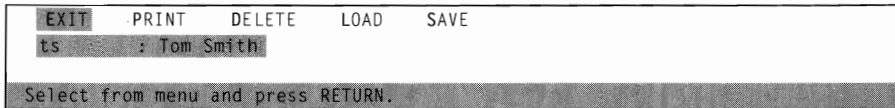

1. From the ABBREVIATED PHRASE screen, press **MENU** to display a menu of functions:

NOTES:

- To return to the input screen shown in step (3) above, press **CANCEL**.
 - To select a function from the menu, use **←** and **→** or type the letter displayed in bold.
 - When the menu is displayed, it is not possible to select a line of data.
2. To exit the abbreviated phrase maintenance screen and return to the input screen, select EXIT and press **RETURN**.
 - **Accelerator:** To select EXIT, type "E".
 - **Short cut:** To exit without displaying the menu, press **FILE**.
 3. To print the list of phrases and names, select PRINT and press **RETURN**.
 - **Accelerator:** To select PRINT, type "P".
 - **Short cut:** To print without displaying the menu, press **CODE** + **PRINT** (**P**).
 4. To delete a line of data, you must select the data before you display the function menu. When the data to be deleted is selected, press **MENU**, then select DELETE and press **RETURN**. A message will ask for confirmation:

Delete? Press RETURN(yes) or CANCEL(no).

- **Accelerator:** To select DELETE from the menu, type "D".
 - **Short cut:** To delete without displaying the menu, press **CODE** + **D**. Press **RETURN** to delete the line or **CANCEL** to keep it in memory.
5. To load an abbreviated phrase file, insert the diskette, select LOAD and press **RETURN**. Remember that loading an abbreviated phrase file will overwrite the abbreviated phrase memory.
 - **Accelerator:** To select LOAD, type "L".
 6. To save the abbreviated phrase memory, select SAVE and press **RETURN**. Remember that turning the power off clears the abbreviated phrase memory, and that saving the abbreviated phrase memory into a diskette that already contains an abbreviated phrase file will overwrite the file on that diskette.
 - **Accelerator:** To select SAVE, type "S".

Loading an Abbreviated Phrase File

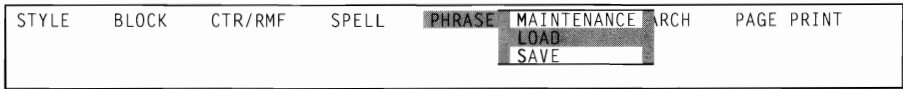

1. Insert the diskette which contains the abbreviated phrase file that you want to use.
2. Press **MENU** to display the function menu.
3. Use **←** and **→** to select PHRASE, then press **↓** or **RETURN** to display the sub-menu.
 - **Accelerator:** *Instead of (3), type "A".*
4. Use **↑** and **↓** to select LOAD and press **RETURN**. The abbreviated phrase file is loaded into the abbreviated phrase memory and you can now use the abbreviated phrases as explained above.
 - **Accelerator:** *Instead of (4), type "L".*

NOTE:

If you had already input data in the abbreviated phrase memory (see "Abbreviated Phrase Maintenance" above), that data will be overwritten when you load a file. To avoid this, first save the current abbreviated phrase data.

Saving the Abbreviated Phrase Memory

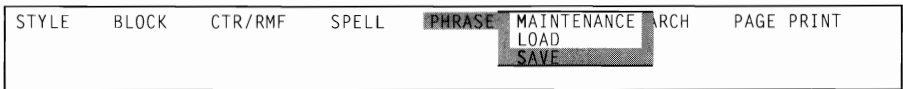

Since the abbreviated phrase memory is cleared when the power is turned off, you should always save its contents before you switch the power off.

1. Insert the diskette in which you want to save the abbreviated phrase memory.
2. Press **MENU** to display the function menu.
3. Use **←** and **→** to select PHRASE, then press **↓** or **RETURN** to display the sub-menu.
 - **Accelerator:** *Instead of (3), type "A".*
4. Use **↑** and **↓** to select SAVE and press **RETURN**. This message will appear:

Press RETURN to save.

- **Accelerator:** *Instead of (4), type "S".*
5. Press **RETURN** to save the abbreviated phrase memory on the diskette.

NOTE:

Since the system accepts only one abbreviated phrase file per diskette, saving the file will overwrite any old abbreviated phrase file on diskette.

Typewriting

When you start the Typewriter application, you will find that the word processor works just like an electronic typewriter. All your typing will be immediately printed on paper and will not affect the memory. The text you type is not stored in memory. If you already have some text in the memory (this is possible because you are allowed to switch to the typewriter application while editing a file), that text will not be changed by the operations done with the typewriter application. The typewriter is equipped with a separate line memory, allowing for easy correction of the current line of text. If a line has to be processed before printing (when centering, for example), the line is temporarily displayed on the screen, and is printed when you press **RETURN** or **TAB**.

Starting the Typewriter Application

From the Main Menu



1. Switch the power on to display the Main menu.
2. Use the cursor keys to select the icon for Typewriter and press **RETURN**, or press **2** or **TW/WP**. The Typewriter screen shown next page appears.

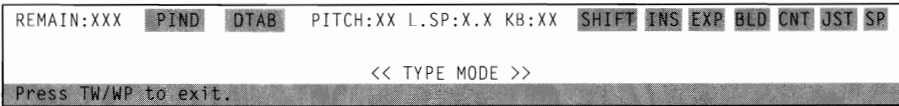

From the Word Processing Application



While using the WP application, you can immediately switch to the TW application by pressing **TW/WP**.

NOTE:

When the word processor finds a stop symbol in a file during file printing, it switches automatically to the typewriter application to allow you to manually add text in the document being printed. For details, see "Stop Symbols" on page 68.

Settings such as left/right margins, tabs, etc. are independent in the Word Processing and Typewriter applications. That is, if you set the left margin to column 5 with the word processor, then switch to the typewriter and set the left margin to column 10, this does not modify your setting for the word processor. If you switch the system back to the word processor, the left margin is still in column 5.

The typewriter application is divided into four modes: the normal mode, where all you type is printed directly, with no auto return; the auto mode, which is like the normal mode but with auto return; the line-by-line mode, which has a one-line memory displayed on the screen as well as auto return; and the justify mode, which also has a one-line memory (with screen display) in addition to justified right margins. These modes are switched by pressing **CODE** + **OPERATE** (**O**) in the sequence shown below.

TYPE → **TYPE (Auto)** → **L/L (Auto)** → **L/L (Justify)** → **TYPE**

The Typewriter Application Screen

The following screen appears when you switch the system to the typewriter application. This screen displays the value of various settings, and a line of text when the line in question has to be processed before printing, or when you want to use the line-by-line mode.

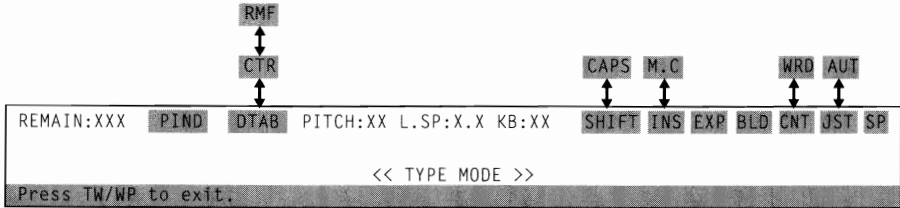

Status Line

The status line indicators show you where you are and what settings are selected. (For a complete list of the indicators, see "Indicators" on page 140.)

The Hot Zone

The hot zone starts six spaces before the right margin. The typewriter will beep when the carrier enters that zone. The REMAIN indicator tells you the number of characters that you can still type on the current line.

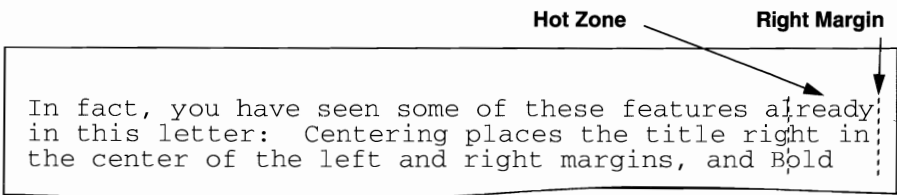

Manual Return

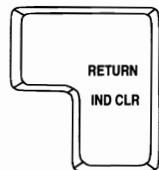

Pressing **RETURN** advances the paper by the current line space and moves the carrier to the left margin.

Automatic Return



Pressing **CODE** + **OPERATE** (**O**) sets the typewriter in the auto mode. The carrier is automatically returned to the left margin if you type a space or a hyphen within the hot zone.

NOTES:

- If you do not want the carrier to return when you type a space (the next word can still fit in the hot zone), press **CODE** + **(SPACE BAR)** instead of **(SPACE BAR)**.
- If you don't want the carrier to return when you type a hyphen (the hyphen is part of the word and the characters following this hyphen can still fit in the hot zone—example: "built-in"), press **CODE** + **-** instead of **-**.
- If you reach the right margin, the typewriter stops. Press **RETURN** to return the carrier, or **CODE** + **M REL** to continue typing beyond the margin.

Line-by-Line Mode

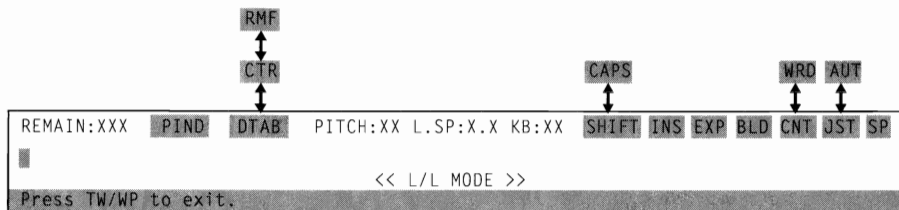
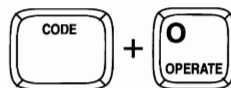

You can enter the line-by-line mode and switch between the other sub-modes with **CODE** + **OPERATE** (**O**).

1. Press **CODE** + **OPERATE** (**O**) while in the auto mode of the type mode to display the L/L mode screen. A text area limited to a single line appears in the middle of the screen.

NOTES:

- In L/L mode, automatic return is always activated. (See "Automatic Return" on page 86.)
- If you need to justify your text, press **CODE** + **OPERATE** (**O**) again to activate the justify function and display the JST indicator.

2. Type your text. The text is displayed on the screen and the carrier moves as you type, although nothing is printed. If you press a dead key, the carrier does not move until you have pressed the base character.
3. To print what you have typed, press **RETURN**, **TAB**, **CODE** + **P IND**, **CODE** + **L IND (L)**, or **CODE** + **IND CLR**. Printing will also be done automatically after you type a character following a hyphen or a space in the hot zone.

Justification Mode

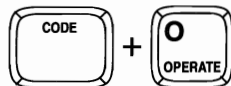

The Justification mode allows you to print text aligned to both left and right margins.

1. Press **CODE** + **OPERATE (O)** until the JST indicator appears.
2. Type your text. The text is displayed on the screen first and the carrier moves simultaneously as you type. If you type a space in the hot zone, justified text is printed and the carrier is automatically returned. Typing a hyphen in the hot zone justifies after typing the next character.

NOTES:

- Pressing **RETURN** aligns the line with the left margin only.
- The carrier will not return automatically if you type a space when the last entered character of a word reaches the right margin. In this case, you must press **RETURN**.

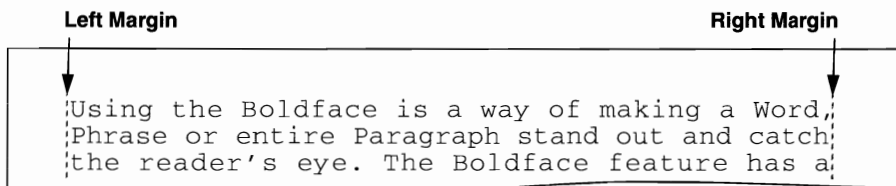

Basic Typing

Inserting Paper



Insert a sheet of paper and press **P INS**. Paper is automatically fed. You can start typing at approximately one inch from the top of the paper. Since the carrier is positioned at the center after automatic insertion, press **RETURN** to move the carrier to the left margin.

NOTES:

- Paper cannot be inserted this way while in display mode (centering, right margin flush, decimal tab mode).
- Paper can be inserted this way in L/L mode only before entering text on the screen.

The Cursor Keys

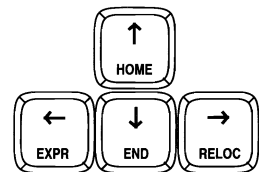

The cursor keys can be used to move the carrier (except when the text of the line is temporarily displayed). **←** and **→** move the carrier one character pitch to the left or the right. **↑** and **↓** move the carrier up or down by 1/12 of an inch (the paper moves), except when the text is displayed on the screen.

Setting Margins

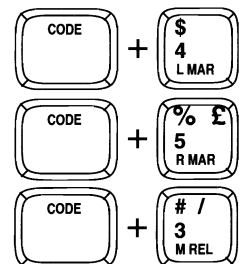

1. Move the carrier by using **(SPACE BAR)** or **TAB** (to move to the right) or **BACKSPACE** or **CODE** + **EXPR** (to move to the left).
2. If you want to set the new margins beyond the old ones, press **CODE** + **M REL** when the carrier reaches the current margin.
3. To set a margin at the carrier position, press **CODE** + **L MAR** or **CODE** + **R MAR**.

NOTES:

- Margins cannot be set while in display mode (centering, right margin flush, decimal tab) or in L/L mode.
- There must be at least two inches between margins.
- The margin settings are reset to their default values when you switch the power off, then on.

Selecting the Pitch

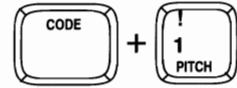

Pressing **CODE** + **PITCH** changes the pitch through the following cycle:

PITCH:10 → 12 → 15 → 10

Pitch	Number of Characters per inch
10 (PICA)	10 characters per inch
12 (ELITE)	12 characters per inch
15 (MICRON)	15 characters per inch

NOTES:

- The pitch cannot be changed while in display mode (centering, right margin flush, decimal tab mode).
- The pitch can be changed in L/L mode only before entering text on the screen.
- The pitch setting is reset to its default value when you switch the power off, then on.

Selecting the Line Space

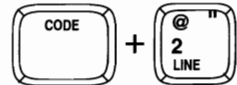

Pressing **CODE** + **LINE** changes the line space through the following cycle:

L.SP:1.0 → 1.5 → 2.0 → 1.0

Line Spacing	Number of Lines per inch
1.0	6 lines per inch
1.5	4 lines per inch
2.0	3 lines per inch

NOTE:

The line space setting is reset to its default value when you switch the power off, then on.

Changing the Keyboard

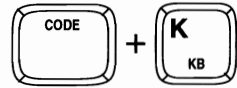

If you need to print characters that are not available on the current daisy wheel, change the daisy wheel and press **CODE** + **KB** (**K**).

KB:I → **II** → **III** → **I**

Keyboard Selection	Use
I (Standard)	English text
II (International)	Languages using extra characters
III (Symbol)	Mathematical symbols and Greek characters

NOTES:

- Please refer to “Character Keys” on page 128 for details.
- The keyboard setting cannot be changed while in display mode (centering, right margin flush, decimal tab mode).
- The keyboard setting can be changed in L/L mode only before entering text on the screen.
- The keyboard setting is reset to its default value when you switch the power off, then on.

Using Shift Lock and Capital Lock

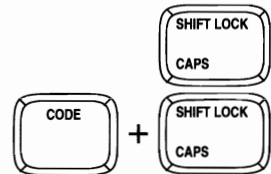

Uppercase characters will be printed if you hold **SHIFT** down while pressing any character key.

To type an entire string of uppercase characters, press **SHIFT LOCK** once. The **SHIFT** indicator appears and all characters you type will be uppercase characters. To cancel, press **SHIFT**.

If you want to enter strings of capital letters in combination with numbers, press **CODE** + **CAPS**. The **CAPS** indicator will appear and all alphabetic keys will type capitals while other keys produce lower case characters. To cancel, press **CODE** + **CAPS** again. When the **CAPS** indicator is on, holding down **SHIFT** temporarily changes the **CAPS** indicator to the **SHIFT** indicator. Pressing **SHIFT LOCK** in the same circumstance switches to **SHIFT**. Pressing **SHIFT** switches back to **CAPS**.

Pitch	Relative Amount of Backspace
10 (PICA)	1/6 of a character
12 (ELITE)	1/5 of a character
15 (MICRON)	1/4 of a character

NOTES:

- If **CODE** + **BS 1** is pressed when the carrier is on the left margin or on the left end, the typewriter beeps. Pressing **CODE** + **M REL** allows the carrier to go beyond the left margin.
- When the text is displayed (centering, right margin flush, decimal tab or L/L mode) **CODE** + **BS 1** is used to superimpose characters. (See "Permanent Backspace" next)

Permanent Backspace

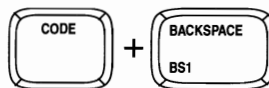

The permanent backspace function is used to print superimposed characters in the display mode (centering, right margin flush, decimal tab, and L/L mode). For example, "0" and "r" are used to produce a "strike-over" zero (Ø), or "Y" and "=" to produce a Japanese Yen currency symbol (¥).

1. Type the base character "Y".
2. Press **CODE** + **BACKSPACE**. The cursor will move one space to the left.
3. Type the character which is to be imposed "=". The base character "Y", a permanent backspace symbol ←, and the character to be imposed "=" will be displayed side by side.

NOTE:

In type mode, you do not need to press **CODE**. Pressing **BACKSPACE** alone moves the carrier back to the last character and you can superimpose another character.

Express Backspace

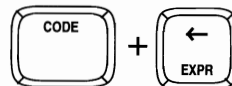

Pressing **CODE** + **EXPR** moves the carrier all the way to the left margin. If you press **CODE** + **M REL**, the carrier moves all the way to the left end.

NOTES:

- When you have a paragraph indent and the carrier is located at its right, pressing **CODE** + **EXPR** once moves the carrier to the paragraph indent; pressing the same keys again moves the carrier to the left margin.
- If **CODE** + **EXPR** is pressed when the carrier is on the left margin or on the left end, the typewriter will beep.
- Pressing **CODE** + **EXPR** moves the cursor to beginning of the line in the display mode.

Subscripts and Superscripts

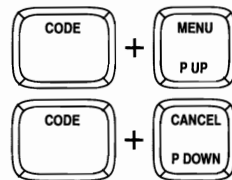

To type subscripts, press **CODE** + **P UP**. In the type mode, this will move the paper up 1/12 inch, and in the L/L mode, will move the cursor to the lower portion of the line on the screen being typed. All the characters you type from now on will be printed lower than the previous characters. To cancel this function, press **CODE** + **P DOWN**.

Superscripts are created similarly, except that you have to start with **CODE** + **P DOWN** and cancel with **CODE** + **P UP**.

NOTE:

If either **CODE** + **P UP** or **CODE** + **P DOWN** are pressed twice in a row in type mode, the auto correction function will be disabled. If this is done in the L/L mode after the data has been input, a beep will sound.

Accents and Special Symbols ("Dead" Keys)

The multilingual keyboard supports the characters with accent marks of such languages as French, German, and Spanish, as well as special symbols.

1. Switch the KB indicator to **II** (International) or **III** (Symbol) using **CODE** + **KB** (**K**). (See "Changing the Keyboard" on page 90.)
2. Install the appropriate print wheel. (See "Changing the Daisy Wheel Cassette" on page 145.)
3. Type the dead character. (See "Character Keys" on page 128.)
4. Type the base character.

NOTE:

In display mode, the dead character and the base character are displayed side by side (Example: ^a).

Corrections

This typewriter has a one line correction memory that makes it possible to erase any character or word automatically. This function, however, works only with the current line.

Automatic Correction

Correcting One Character



To correct a character on the current line, use **BACKSPACE** to move the carrier to the mistyped character, press **CORRECT** to erase, then retype the correct character.

NOTES:

- Pressing **CORRECT** on a space moves the carrier back.
- Pressing **CORRECT** deletes the character positioned left of the cursor while in centering, right margin flush, decimal tab, and L/L modes.

Erasing One Word



To erase an entire word, position the carrier next to the last character of the word and press **WORD OUT**. The entire word is erased and you can retype.

NOTES:

- Automatic erasing in progress can be stopped by pressing **CORRECT**.
- Position the cursor to the space immediately to the right of the word to be deleted while in centering, right margin flush, decimal tab, and L/L modes.

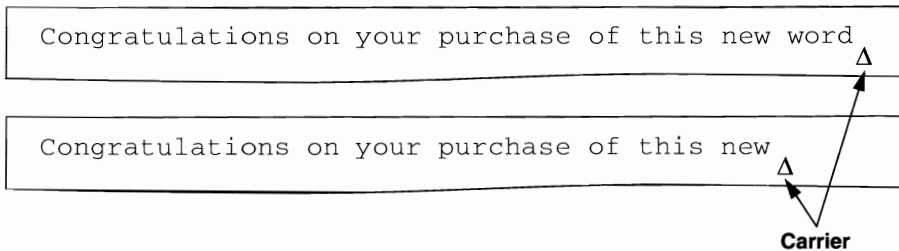

Erasing One Line

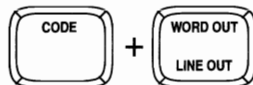

To erase an entire line, position the carrier to the right of the last character on the line and press **CODE** + **LINE OUT**. The entire line is erased and you can retype.

NOTES:

- Automatic erasing in progress can be stopped by pressing **CORRECT**.
- Position the cursor to the space immediately to the right of the last character to be erased while in centering, right margin flush, decimal tab, and L/L modes.

Congratulations on your purchase of this new word Δ

Δ

Relocation of the Carrier

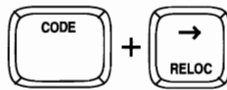

After a correction is made in the middle of the current line, pressing **CODE** + **RELOC** moves the carrier to the position next to the last character.

NOTE:

Pressing **CODE** + **RELOC** moves the cursor to the space immediately to the right of the last data while in the centering, right margin flush, decimal tab, and L/L modes.

Manual Corrections

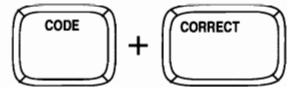

When a correction is required above the current line, or if you have to reinsert the paper, the memory correction does not work because the line memory is cleared each time the paper is fed more than 1/12 inch.

NOTE:

This function cannot be executed while in the centering, right margin flush, decimal tab or L/L mode.

1. Use **CODE** + **P DOWN** (or the platen knob) to position the carrier where a correction is required. Move the carrier to the character to be corrected with **BACKSPACE** or **(SPACE BAR)**. If necessary, use **CODE** + **BS1** to accurately position the carrier.

Congr_Δstulations on your purchase of this new word

2. Press **CODE** + **CORRECT**. The M.C indicator appears.
3. Retype the same character again. The character is erased and the M.C indicator disappears.

Congr_Δ tulations on your purchase of this new word

4. Type the desired character.

Congratulations on your purchase of this new word
_Δ

Formatting the Page

On-Screen Editing

When using the functions listed below, the text that you input appears on the screen but is not actually typed until you press **RETURN** or **TAB**. These functions are the following:

- Decimal Tab
- Centering
- Right Margin Flush

This is because your typewriter needs to know the whole text before it is able to calculate its position on the paper.

While your text is displayed on the screen, you can edit it using the following keys:

Key	Function
BACKSPACE CORRECT WORD OUT CODE + LINE OUT	To delete the character(s) at the left of the cursor and pull the rest of the text to the left.
← →	To position the cursor.
CODE + EXPR	To move the cursor back to the beginning of the line.
CODE + RELOC	To move the cursor to the end of the line.
CODE + INSERT (I)	To switch the insert mode on/off. When the INS indicator is on, typing a character over a ([Key: I]) previously typed character will not replace the old character. It will instead display the new character at the cursor position, then push the rest of the text one position to the right.

Tabs and Decimal Tabs

You can set a total of 30 tabs or decimal tabs. Tabs and decimal tabs make it easy to position the carrier at preset positions and have a text arranged in columns. Decimal tabs are used to automatically align the decimal point of numbers with preset positions.

Setting Tabs and Decimal Tabs

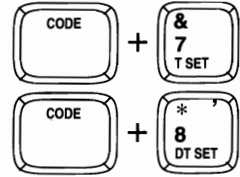

Move the carrier to the desired position and press **CODE** + **T SET** to set an ordinary tab, or **CODE** + **DT SET** to set a decimal tab.

NOTES:

- *Tabs and decimal tabs cannot be set in the display mode.*
- *The tab settings are erased when you switch the power off.*

Clearing Tabs

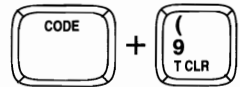

To clear a tab, move the carrier to that position and press the **CODE** + **T CLR**.
To clear all tabs, hold down the same keys until this message appears:

All tabs cleared.

Typing with Tabs

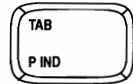

To move the carrier to the next tab to the right, press **TAB**. If there are no more tabs or decimal tabs to the right, the carrier moves to the right margin. When the carrier is on the desired tab stop, start typing. Press **RETURN** to move the carrier back to the left margin and feed paper, or **TAB** to move to the next tab.

Typing with Decimal Tabs

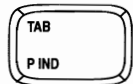

When you press **TAB** to move the carrier to the next decimal tab, the DTAB indicator appears. When this indicator is on, you can type a number. This will be displayed on the screen. When you type the decimal point, however, all that you have typed will be printed with the decimal point aligned at the decimal tab. You can then enter the fractional part of the number, which is printed as you type it. The carrier then moves to the left margin if you press **RETURN**, or to the next tab or decimal tab if you press **TAB**.

NOTES:

- *Pressing **CANCEL** or **CORRECT** before you type anything deactivates the decimal tab function and returns you to normal typing. This is useful when you press **TAB** to move to the next tab and reach a decimal tab instead.*

- You cannot use the decimal tab function when the centering or right margin flush function is activated

Tab	Decimal Tab
May	129.84
June	34.97
July	7864.81

Line Indent

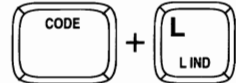

Pressing **CODE** + **L IND** (**L**) is the same as typing five spaces. The primary use is in indenting the first line of paragraphs.

Line Indent

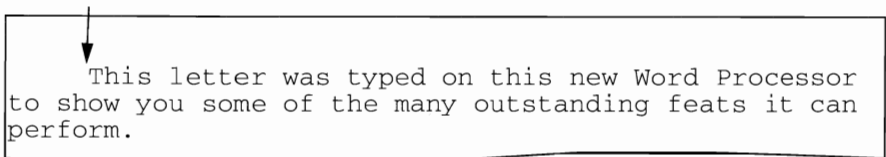

Paragraph Indent

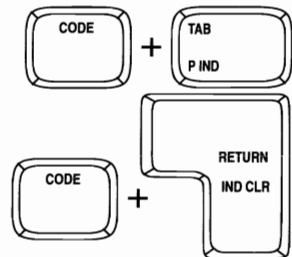

Paragraph indent works like a temporary left margin. The most common application is numbered paragraphs.

First set a tab at the desired indent position and press **RETURN**, to move back to the left margin. Press **CODE** + **P IND**. The PIND indicator appears. From now on the carrier will return to that temporary left margin. To cancel this, press **CODE** + **IND CLR**.

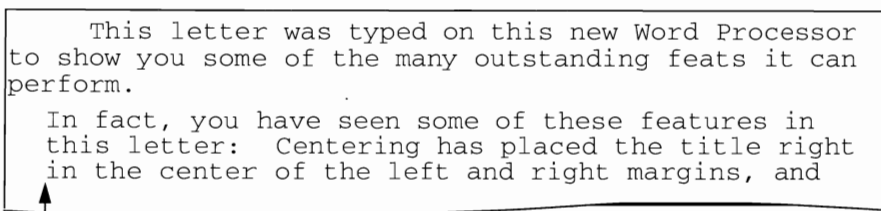

Paragraph Indent

Text Emphasis (Style)

The style function allows you to highlight an important part of your text using bold-face characters, underlining, or expand (a space is automatically inserted between the characters). These functions can be used together in any combination.

Bold

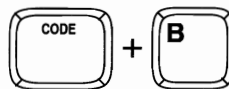

1. Press **MENU** to display the menu.
2. Use **←** and **→** to select STYLE, and press **RETURN** or **↓**.
 - **Accelerator:** Instead of (2), type "S".
3. Use **↑** and **↓** to select BOLD.
4. Use **(SPACE BAR)** to select ON.
 - **Accelerator:** Instead of (3) and (4), type "B".
5. Press **RETURN**. The BLD indicator appears.
 - **Short cut:** Instead of (1), (2), (3), (4), and (5), press **CODE** + **B**. If the function was OFF it is switched to ON and vice-versa.
6. Type your text. The characters are automatically bolded.
7. To return to normal typing, repeat steps (1) to (5) to turn the bold OFF (or press **CODE** + **B**).

Using the **Boldface** is a way of making a Word, Phrase or entire Paragraph stand out and catch the reader's eye. The **Boldface** feature has a

Underline

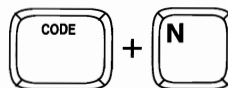

1. Press **MENU** to display the menu.
2. Use **←** and **→** to select STYLE, and press **RETURN** or **↓**.
 - **Accelerator:** Instead of (2), type "S".
3. Use **↑** and **↓** to select UNDERLINE.
4. Use **(SPACE BAR)** to select CNT (continuous) or WRD (word).

- **Accelerator:** Instead of (3) and (4), type "U".
5. Press **RETURN**. The corresponding CNT or WRD indicator appears.
 - **Short cut:** Instead of (1), (2), (3), (4), and (5), press **CODE** + **N** to switch the function OFF/CNT/WRD.
 6. Type your text. The characters are automatically underlined. If the CNT indicator is on, everything is underlined; if the WRD indicator is on, spaces are not underlined.
 7. To return to normal typing, repeat steps (1) to (5) to turn the underline OFF (or press **CODE** + **N**).

Continuous Underline

Using the Underline is a way of making a Word, Phrase or entire Paragraph stand out and catch the reader's eye. The Underline feature has a

Word Underline

Using the Underline is a way of making a Word, Phrase or entire Paragraph stand out and catch the reader's eye. The Underline feature has a

Expand

STYLE	BOLD	OFF	ALL
	UNDERLINE	OFF	
	EXPAND	OFF	

1. Press **MENU** to display the menu.
2. Use **←** and **→** to select STYLE, and press **RETURN** or **↓**.
 - **Accelerator:** Instead of (2), type "S".
3. Use **↑** and **↓** to select EXPAND.
4. Use **(SPACE BAR)** to turn the function ON.
 - **Accelerator:** Instead of (3) and (4), type "E".
5. Press **RETURN**. The EXP indicator appears.
6. Type your text. A space is automatically inserted after each character.
7. To return to normal typing, repeat steps (1) to (5) to turn the expand OFF.

C O P Y ← Expand

This letter was typed on this new Word Processor to show you some of the many outstanding feats it can perform.

Centering and Right Margin Flush Functions

Centering Between Margins or Between Tabs

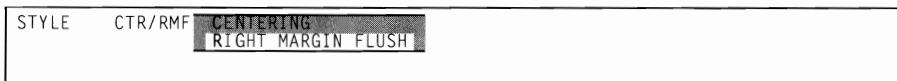
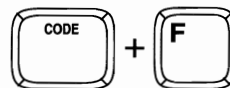

The centering function is used to center text between the margins. It can also be used to center items of a table between two tab stops.

1. To center between margins, position the carrier on the left margin. To center between tabs, press **TAB** to move the carrier to the first tab of the centering range. The text will be centered between that tab and the next tab (or the right margin if there are no more tabs).
2. Press **MENU** to display the menu.
3. Use **←** and **→** to select CTR/RMF, and press **RETURN** or **↓**.
 - **Accelerator:** Instead of (3), type "C".
4. Use **↑** and **↓** to select CENTERING and press **RETURN**. The CTR indicator appears.
 - **Accelerator:** Instead of (4), type "C".
 - **Short cut:** Instead of (2), (3), and (4), press **CODE** + **F**.
5. Type your text. The text is temporarily displayed on the screen and you can edit your text.
6. Press **RETURN** or **TAB**. The text is printed.

NOTES:

- Pressing **CANCEL** before any data has been input switches back to the normal mode.
- The centering function cannot be executed while in the decimal tab or right margin flush mode.
- The centering function cannot be executed if the carrier is not first positioned on the left margin or on a tab.

Centering Between Margins

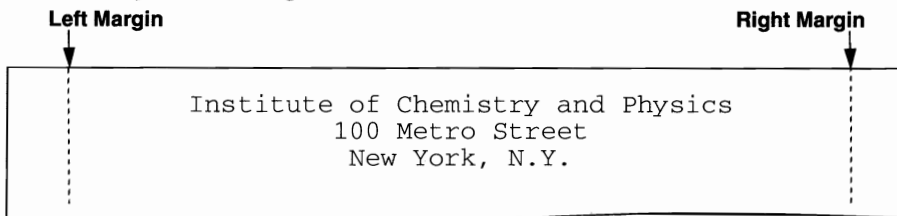

Centering Between Tabs

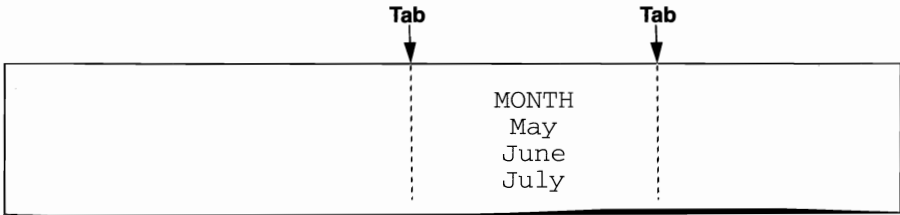

Right Margin Flush (RMF)

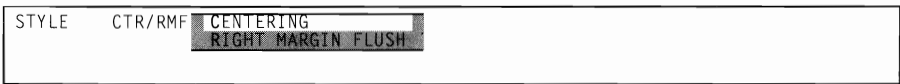
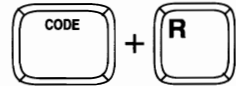

The right margin flush function is used to position the last character of a line exactly on the right margin.

1. Press **MENU** to display the menu.
2. Use **←** and **→** to select CTR/RMF, and press **RETURN** or **↓**.
 - **Accelerator:** Instead of (2), type "C".
3. Use **↑** and **↓** to select RIGHT MARGIN FLUSH and press **RETURN**. The RMF indicator appears.
 - **Accelerator:** Instead of (3), type "R".
 - **Short cut:** Instead of (1), (2), and (3), press **CODE** + **R**.
4. Type your text. The text is temporarily displayed on the screen and you can edit your text.
5. Press **RETURN** or **TAB**. The text is printed.

NOTES:

- Pressing **CANCEL** before any data has been input switches back to the normal mode.
- The right margin flush function cannot be executed while in the decimal tab or centering mode.

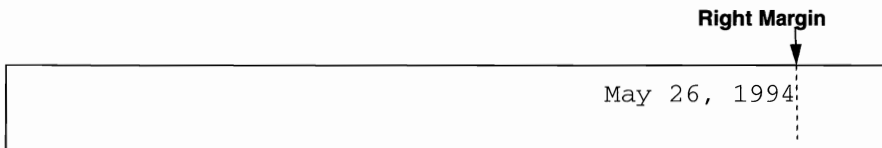

THIS PAGE LEFT BLANK INTENTIONALLY

Spell Checker

This word processor has a Spell Checker that searches for misspelled and “double” words, and allows you to correct them. A user dictionary can be created to store foreign words or brand names that are not standard English.

Description of the Spell Checker

The functions of the Spell Checker are selected from the function menu in WP and TW modes:

WP Application

STYLE	BLOCK	CTR/RMF	SPELL	SPELL CHECK	PAGE PRINT
				USER DICTIONARY MAINTENANCE	
				USER DICTIONARY LOAD	
				USER DICTIONARY SAVE	

TW Application

STYLE	CTR/RMF	SPELL	SPELL CHECK
			USER DICTIONARY MAINTENANCE
			USER DICTIONARY LOAD
			USER DICTIONARY SAVE

SPELL CHECK is used for activating the Spell Checker system. The Spell Checker detects spelling mistakes and “double” (repeated) words. With the WP application, you can check an entire document (ALL option) or have the system check each word while you are typing (ONE WORD option). With the TW application, the system automatically selects the ONE WORD option.

USER DICTIONARY MAINTENANCE allows you to create and edit the user dictionary. The user dictionary is used to store words that are not found in the Spell Checker.

USER DICTIONARY LOAD is used to recall the user dictionary previously saved on the diskette.

USER DICTIONARY SAVE is used to save the user dictionary onto a diskette.

Spell Checker (Word Spell)

The Spell Checker comes with a built-in dictionary of about 70,000 English words. When checking your text, the Spell Checker automatically compares each word with the contents of the built-in dictionary. If a word is not found in the built-in dictionary, the word processor assumes that the word in question is misspelled and warns you.

The built-in dictionary contains only standard English words, and will consider words like brand names, people's names, or foreign language words as misspelled words, even if those words are correct. If you frequently use such words in your document, you should create a "User Dictionary" and store those words in that dictionary. The user dictionary is kept in the memory for as long as the power is on. When a word cannot be found in the built-in dictionary, the Spell Checker will scan the user dictionary and warn you only if the word cannot be found there.

When a word cannot be found in either dictionary, the Spell Checker gives you a menu of options:

- You can **IGNORE** the warning and keep the suspect word unchanged.
- You can ask for **SUGGESTIONS**. In this case, the Spell Checker will supply possible replacement word(s) for the suspect word.
- You can also directly **RETYPE** the word correctly. This option is used when the error is evident and easy to correct, or when the system cannot provide the correct suggestion.
- You can **ADD** the suspect word to the user dictionary. This is useful when the suspect word, although correct, is not a standard English word. Once the word is stored in the user dictionary, the Spell Checker will not warn you the next time the same word is found.

The Spell Checker also detects double words (you typed the same word twice). When this happens, a menu of options appears:

- You can **IGNORE** the warning and keep the repeated word in the text.
- You can automatically **ERASE** the **SECOND WORD**.

NOTE:

This system is not a replacement for careful proofreading of your documents. It has no way of knowing, for example, whether words are missing or whether a given word is appropriate for the current context. If you type "teh" instead of "the", the spell checker alerts you because "teh" is not a valid English word, but if you type "one" instead of "on", it does not consider it a mistake.

Checking Existing Text (WP Application)

With the WP application, you can automatically scan the entire document for problems. The scan is one-directional – that is, it starts at the word where the cursor is located and works toward the end of the document.

Starting the Spell Checker

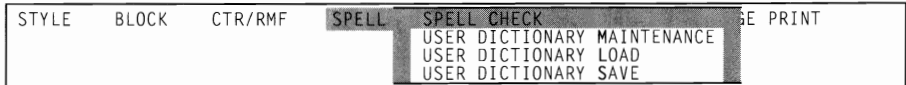
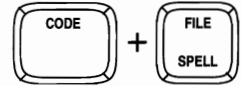

1. Position the cursor at the location in the document where you want to start checking. For example, if you want to check the entire document, position the cursor on the first word of the document.
2. Press **MENU** to display the function menu.
3. Use **←** and **→** to select **SPELL**, then press **↓** or **RETURN** to display the sub-menu.
 - **Accelerator:** Instead of (3), type "L".
4. Use **↑** and **↓** to select **SPELL CHECK** and press **RETURN**. The following menu appears:

Use cursor to select. Press RETURN.

ALL ONE WORD

- **Accelerator:** Instead of (4), type "C".
 - **Short cut:** Instead of (2), (3), and (4), press **CODE** + **SPELL**.
5. Use **←** and **→** to select **ALL** and press **RETURN**. The Spell Checker starts scanning your text for misspelled word and displays the message:

Checking....

While Checking (Suspect & Repeated Words)

When a suspect or repeated word is found, the above message disappears and is replaced with a menu of options. The suspect word is highlighted in the text.

Example 1

Let's suppose that you have typed "The quick broen fox..." ("broen" is suspect)

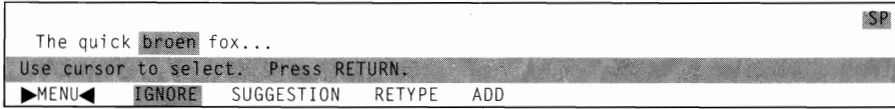

Use **←** and **→** to select an option and press **RETURN**.

1. If you select **IGNORE**: the system start searching for the next suspect word. The word "broen" will not be corrected.
2. If you selected **SUGGESTION**: a menu of possible replacement words appears.

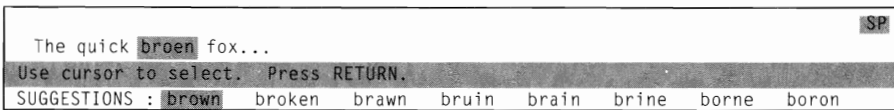

Use **←** and **→** to select the replacement word and press **RETURN**. The word will automatically replace the one in the text, and the system starts searching for the next suspect word. If the correct word does not appear in the suggestion menu, press **CANCEL** to return to the first menu and select **RETYPE** as explained below.

3. If you select **RETYPE**: an input area appears so that you can type the correct word:

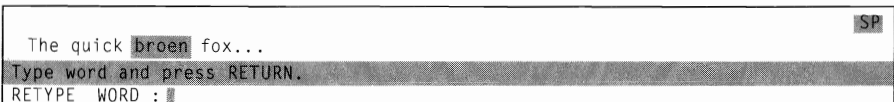

You can immediately type the correct word and press **RETURN**. The correct word replaces the one in the text, and the system starts searching for the next suspect word.

You can also press **↓** first. This will display the suspect word in the input area so that you can correct it in a few keystrokes. Press **RETURN** when the word is corrected.

4. If you select **ADD**: the suspect word is added to the user dictionary. (From now on, it will not be considered "suspect" any more.) The following message appears:

Word added to user dictionary.

NOTE:

If you add words to the user dictionary, you will have to save the user dictionary onto a diskette before turning the power off. (See "Saving the User Dictionary" on page 115.)

Example 2

Let's now suppose that you have typed "The quick brown fox fox..." (the second "fox" is a double word)

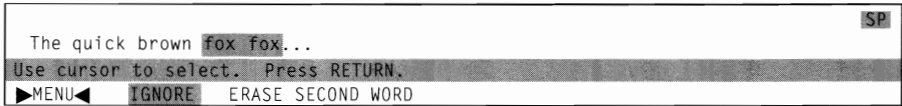

Use **←** and **→** to select an option and press **RETURN**.

1. If you select **IGNORE**: the word is kept in the text and the system starts searching for the next suspect or double word.
2. If you select **ERASE SECOND WORD**: the word is deleted and the system starts searching for the next suspect or double word.

The process repeats to the end of the document (a message will tell you that you reached the end of the document) or until you press **CODE** + **SPELL** or **CANCEL** to turn the Spell Checker off.

Checking While Typing (WP or TW Application)

The Spell Checker can be used to check each word as you type. You can do this either in the WP or TW applications.

Starting the Spell Checker

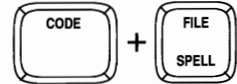

If you are working with the WP application, refer to “Starting the Spell Checker” on page 108. The only differences between the “One Word” procedure and the “All” procedure are: 1) position the cursor at the location where you are going to type, and 2) when the option menu “ALL ONE WORD” appears, select ONE WORD. The Spell Checker will be automatically activated.

If you are working with the TW application, proceed as follows:

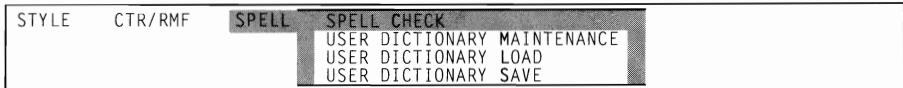

1. Press **MENU** to display the function menu.
2. Use **←** and **→** to select SPELL, then press **↓** or **RETURN** to display the sub-menu.
 - **Accelerator:** *Instead of (2), type “L”.*
3. Use **↑** and **↓** to select SPELL CHECK and press **RETURN**.
 - **Accelerator:** *Instead of (3), type “C”.*
 - **Short cut:** *Instead of (1), (2), and (3), press **CODE** + **SPELL**.*

Once the Spell Checker is started, the SP indicator appears on the screen. The words you type are checked for spelling or redundancy. If an error is found, the system interrupts your typing and displays a menu of options. See “While Checking (Suspect & Repeated Words)” on page 108 for details. In type mode, when you select a suggested word, or when you retype a replacement word, the old word is automatically erased and the system prints the replacement word.

NOTES:

- *In the TW application, when you move the carrier or the cursor over existing text, the system will detect errors even if it was started after typing that text. (This feature is limited to the current line).*
- *To disable the Spell Checker, press **CODE** + **SPELL**.*

The User Dictionary

How the User Dictionary Works

A user dictionary is created automatically when you select the ADD function to add a word to the dictionary. This dictionary is held in memory for as long as the word processor is on. If you add words to the user dictionary and would like to use the same dictionary for checking other files, you must SAVE the user dictionary onto a diskette before switching your unit off. (See "Saving the User Dictionary" on page 115.) Later, when you want to use that same dictionary, you must LOAD it from the diskette to use it. (See "Loading a User Dictionary" on page 114.)

NOTES:

- Each diskette can hold only one user dictionary. If you save a user dictionary onto a diskette that already contains a user dictionary, the dictionary previously on the diskette will be overwritten by the new user dictionary.
- The memory of the word processor can hold only one dictionary. If you create a dictionary in the memory, and then load a dictionary from a diskette, the dictionary currently in the memory will be overwritten by the loaded dictionary.

Maintaining the User Dictionary

Beside the ADD option that allows you to add a suspect word to the user dictionary, the Spell Checker system provides you with tools for editing the user dictionary.

WP Application

STYLE	BLOCK	CTR/RMF	SPELL	SPELL CHECK	USE PRINT
				USER DICTIONARY MAINTENANCE	
				USER DICTIONARY LOAD	
				USER DICTIONARY SAVE	

TW Application

STYLE	CTR/RMF	SPELL	SPELL CHECK
			USER DICTIONARY MAINTENANCE
			USER DICTIONARY LOAD
			USER DICTIONARY SAVE

1. Press **MENU** to display the function menu.
2. Use **←** and **→** to select SPELL, then press **↓** or **RETURN** to display the sub-menu.
 - **Accelerator:** Instead of (2), type "L".
3. Use **↑** and **↓** to select USER DICTIONARY MAINTENANCE and press **RETURN**. The following display appears.

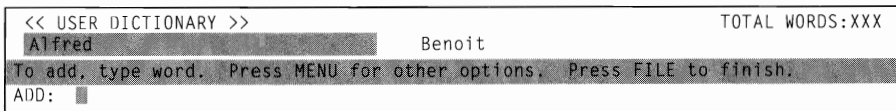

- **Accelerator:** Instead of (3), type "M".
4. To add a new word, type it and press **RETURN**. The new word will be inserted in the list in alphabetical order. The system will tell you if you try to input a word that already exists in the user dictionary.

NOTES:

- On the User Dictionary screen, the keyboard is automatically set to KB: I.
 - If you have added words to the user dictionary, you must save the user dictionary onto a diskette before turning the power off. (See "Saving the User Dictionary" on page 115.)
5. To return to normal typing, press **FILE**.

Using the Function Menu

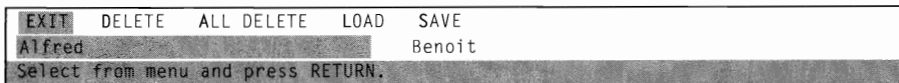

- To select a word, use **↑**, or **↓**.
- To find a specific entry faster, press **CODE** + **GOTO** (**G**) to go closer to the word that you want to select. A message will ask you to enter the first letter of the word:

Type letter to move cursor.

Type the letter.

1. From the USER DICTIONARY screen, press **MENU** to display a menu of function:

NOTE:

To select a function from the menu, use **←** and **→** or type the letter displayed in bold.

2. To exit the user dictionary maintenance screen, select EXIT and press **RETURN**.
 - **Accelerator:** To EXIT from the menu, type "E".
 - **Short cut:** To exit without displaying the menu, press **FILE**.
3. To delete a word, first select the word from the user dictionary screen. Press **MENU** and select DELETE. The following message appears:

Delete the word from user dictionary? Press RETURN(yes) or CANCEL(no).

- **Accelerator:** To select DELETE from the menu, type "D".
 - **Short cut:** To enable the DELETE function without displaying the menu, press **CODE** + **D**.
Press **RETURN** to delete, or **CANCEL** to keep the word in the user dictionary.
4. To delete all words, select ALL DELETE and press **RETURN**. The following message appears:

Delete all words in user dictionary? Press RETURN(yes) or CANCEL(no).

- **Accelerator:** To select ALL DELETE from the menu, type "A".
Press **RETURN** to delete, or **CANCEL** to keep the user dictionary unchanged.
5. To load a different user dictionary file from a different diskette, insert the diskette in the drive, select LOAD and press **RETURN**. Remember that loading a user dictionary file will overwrite the user dictionary currently in memory.
- **Accelerator:** To select LOAD from the menu, type "L".
6. To save the user dictionary, insert a diskette in the drive, select SAVE and press **RETURN**. Remember that turning the power off clears the user dictionary in memory, and that saving the user dictionary onto a diskette which already contains a user dictionary file will overwrite that file on the diskette.
- **Accelerator:** To select SAVE from the menu, type "S".

Loading a User Dictionary

The Spell Checker system allows you to have several user dictionaries, but you cannot store more than one on the same diskette. This feature is very useful when you are dealing with different kinds of documents. For example, if the documents you have to create most frequently are letters (containing people's names) and sales reports (containing company's names) you can store these two kinds of documents on different diskettes, and create the corresponding user dictionary on each diskette.

NOTE:

If you are using the Spell Checker for the first time, your diskette does not contain any user dictionary and you will not be able to load anything.

If you want to reuse an existing user dictionary, first insert the corresponding diskette in the disk drive.

WP Application

STYLE	BLOCK	CTR/RMF	SPELL	SPELL CHECK USER DICTIONARY MAINTENANCE USER DICTIONARY LOAD USER DICTIONARY SAVE	GE PRINT
-------	-------	---------	-------	--	----------

TW Application

STYLE	CTR/RMF	SPELL	SPELL CHECK USER DICTIONARY MAINTENANCE USER DICTIONARY LOAD USER DICTIONARY SAVE
-------	---------	-------	--

1. Press **MENU** to display the function menu.
2. Use **←** and **→** to select SPELL, then press **↓** or **RETURN** to display the sub-menu.
 - **Accelerator:** *Instead of (2), type "L".*
3. Use **↑** and **↓** to select USER DICTIONARY LOAD and press **RETURN**. The user dictionary is now in the word processor memory.
 - **Accelerator:** *Instead of (3), type "L".*

Saving the User Dictionary

When the power is turned off, the user dictionary in memory is deleted. If you want to reuse the same user dictionary to check other documents, do not forget to save it before you turn the power off. The current contents of the user dictionary in memory will replace the user dictionary file on the diskette.

WP Application

STYLE	BLOCK	CTR/RMF	SPELL	SPELL CHECK USER DICTIONARY MAINTENANCE USER DICTIONARY LOAD USER DICTIONARY SAVE	SE PRINT
-------	-------	---------	-------	--	----------

TW Application

STYLE	CTR/RMF	SPELL	SPELL CHECK USER DICTIONARY MAINTENANCE USER DICTIONARY LOAD USER DICTIONARY SAVE
-------	---------	-------	--

1. Press **MENU** to display the function menu.
2. Use **←** and **→** to select SPELL, then press **↓** or **RETURN** to display the sub-menu.
 - **Accelerator:** *Instead of (2), type "L".*
3. Use **↑** and **↓** to select USER DICTIONARY SAVE and press **RETURN**. This message will appear:

Press RETURN to save.

- **Accelerator:** *Instead of (3), type "S".*
4. Press **RETURN** to save the user dictionary on the diskette.

THIS PAGE LEFT BLANK INTENTIONALLY

Mail Merge

The Mail Merge application is used to input and organize data such as a list of names, addresses, telephone and fax numbers into a file called the Merge file. Each entry is called a record and is divided into several labels. Each label is identified with a number (M1, M2, etc.). The list can be edited and printed.

The data of each record can be merged into a Word Processing file that contains Merge Symbols to identify which labels of the record are to be inserted into the text.

The Merge printing feature of the Word Processing application then allows you to create a letter that contains a standard text that may be sent to many people. The variable text of the letter (name, address, etc.) is indicated with Merge Symbols which will be replaced with the corresponding item from the Mail Merge file when printing.

When you save a Mail Merge file, the system automatically adds the extension “.MRG” to the file name.

Starting the Mail Merge Application



1. Switch the power on to display the Main menu.
2. Use the cursor keys to select the icon for Mail Merge and press **RETURN**, (or press **3**). The MERGE INDEX screen appears and shows a list of the Merge files (extension ".MRG").
3. Use the cursor keys to select *NEWFILE and press **RETURN**. The MERGE screen shown below appears.

NOTES:

- After you have completed a work, insert a diskette in the drive and press **FILE** to save the file on a diskette. For details, see "Saving the Merge File" on page 125.
- After saving your work, you will see an updated list of your Merge files on the screen. To return to the Main menu, press **CANCEL**, or press **MENU** to display the function menu, then select EXIT and press **RETURN**.

The MERGE Screen

XXXXXXXX	RECORD:XX	LABEL:XX	KB:XX	REMAIN:X.XX
M1				
* M1				
Type data. Press FILE to finish.				

The MERGE screen displays a single record at a time. The label numbers are displayed on the second line of the screen. With a new blank file, only the first label, M1 is displayed. As you create new labels, they will be automatically numbered M2, M3,...

The Structure of a Merge File

A Merge file is made of several records that are divided into labels. All the records have the same number of labels. Each label is assigned a specific type of information. For example, first name in label M1, second name in label M2, company in label M3, etc. You are free to decide which type of data you are going to enter in each label, but you must consistently enter the same type of data in the same label of all your records. You can imagine the merge as a table: a row corresponds to a record, and a column corresponds to a label.

Label names →	M1	M2	M3	M4
(Contents) →	(Mr/Ms)	(First name)	(Last name)	
Record #1 →	Mr	Terry	Fox	
Record #2 →	Ms	Ruth	Higgins	
Record #3 →	Mr	Kevin	Lee	

A single record contains the variable text that will be inserted in a single letter of the WP application. The letter contains Merge symbols M1, M2, M3, etc. The order in which the Merge symbols are inserted in the letter does not matter. The word processor will always replace a Merge symbol M1, with the data found in label M1. The file can contain a maximum of 99 records, each made of a maximum of 20 labels. The size of a label can be set to 7, 15, 23,...71 characters.

Creating and Editing a Merge File

Entering Data

Move the cursor to the desired label field, then type or correct the data.

NOTES:

- To correct, use **BACKSPACE**, **CORRECT**, **WORD OUT**, and **CODE** + **LINE OUT**.
- To move the cursor within a label field, you can use **←**, **→**. However, when the cursor reaches the left or right border of a label field, it will automatically go to the previous or next label field. **TAB** will also move the cursor to a new label field or move between existing fields.
- Use **CODE** + **INSERT** (**I**) to switch the insert mode on/off.
- Use **CODE** + **BACKSPACE** or the dead keys to superimpose characters (see "Superimposed Characters (Permanent Backspace)" on page 26) or to enter accented letter (see "Accents ("Dead" Keys)" on page 28). If necessary, use **CODE** + **KB** (**K**) to switch the keyboard (see "Switching the Keyboard" on page 54).

Creating a New Label



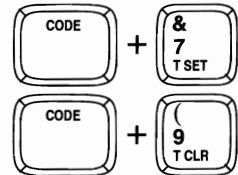

When you start with a blank merge file, the screen displays only one label, M1. After you enter data into this label, press **TAB** to add a new empty label M2. The word processor will automatically add a new label each time you enter data in an empty label.

Changing the Width of a Label



To make a label larger or shorter, proceed as follows:

1. Move the cursor to the label that you want to modify.
2. Press **MENU** to display the function menu.

3. Use  and  to select LABEL and press **RETURN** or  to display the sub-menu.
 - **Accelerator:** Instead of (3), type "L".
4. Use  and  to select LABEL LONGER to increase the width, or LABEL SHORTER to decrease the width and press **RETURN**. The width of the selected column is increased or decreased by eight characters.
 - **Accelerator:** Instead of (4), type "L" to increase, or "S" to decrease.
 - **Short cut:** Instead of (2), (3), and (4), press **CODE** + **TCLR** to increase, or **CODE** + **TSET** to decrease.

NOTES:





- The width of a single column must range between 7 and 71 characters. The word processor does not allow you to make a column narrower than the largest data already entered in that column.
- The maximum width of a record is 168 characters.

Creating a New Record

When you start with a blank merge file, the file contains a single record. After you enter data into this record, the word processor automatically adds a new empty record. Pressing **RETURN** moves the cursor to the beginning of the new record.

Moving the Cursor

You can use the following keys to move the cursor across your file:

Key	Function
 	Moves the cursor one position to the left or the right.
 	Moves the cursor to the previous or next record.
CODE + RELOC CODE + EXPR .	Moves the cursor to the first or last label.
RETURN	Moves the cursor to the beginning of the next record.
CODE + HOME CODE + END	Moves the cursor to the first or last record.
TAB	Moves the cursor to the next label.

Copying Data

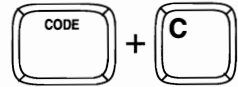

RECORD LABEL DATA COPY PRINT

1. To copy the data of a label (or a part of it), position the cursor on the first character to be copied.
2. Press **MENU** to display the function menu.
3. Use **←** and **→** to select DATA COPY and press **RETURN**. This message will appear:

Move cursor to end of block to copy and press RETURN.

- **Accelerator:** Instead of (3), type "C".
 - **Short cut:** Instead of (2) and (3), press **CODE** + **C**.
4. Use **←** or **→** to mark the text (within the label) that you want to copy and press **RETURN**. This message will appear:

Move cursor to destination for blocked text and press RETURN.

5. Move the cursor to the destination position and press **RETURN**. The marked text is inserted at the destination position.

NOTE:

You can press **CANCEL** at any time to cancel the operation.

Inserting a Blank Record

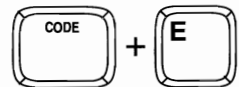

RECORD INSERT DATA COPY PRINT
DELETE

1. Position the cursor on the record where you want to insert a blank record.
2. Press **MENU** to display the function menu.
3. Use **←** and **→** to select RECORD and press **RETURN** or **↓** to display the sub-menu.
- **Accelerator:** Instead of (3), type "R".
4. Use **↑** and **↓** to select INSERT and press **RETURN**. The insertion takes place immediately.
- **Accelerator:** Instead of (4), type "I".
- **Short cut:** Instead of (2), (3), and (4), press **CODE** + **E**.

When you insert a blank record, the record which was initially selected and all records below are pushed down. The cursor rests on the blank record so that you can enter new data.

Deleting a Record

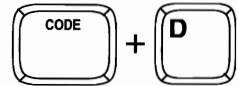

1. To delete a record, position the cursor on the record to be deleted.
2. Press **MENU** to display the function menu.
3. Use **←** and **→** to select RECORD and press **RETURN** or **↓** to display the sub-menu.
 - **Accelerator:** *Instead of (3), type "R".*
4. Use **↑** and **↓** to select DELETE and press **RETURN**. The following message appears:

Delete? Press RETURN(yes) or CANCEL(no).

- **Accelerator:** *Instead of (4), type "D".*
 - **Short cut:** *Instead of (2), (3), and (4), press **CODE** + **D**.*
5. Press **RETURN** to delete the record, or **CANCEL** to quit.

NOTE:

You can press **CANCEL** at any time to cancel the operation.

Printing the Current Record

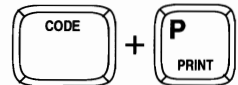

1. Position the cursor on the record you want to print.
2. Press **MENU** to display the function menu.
3. Use **←** and **→** to select PRINT and press **RETURN** or **↓** to display the sub-menu.
 - **Accelerator:** *Instead of (2), type "P".*
4. Use **↑** and **↓** to select ONE RECORD PRINT and press **RETURN** to start printing.
 - **Accelerator:** *Instead of (4), type "O".*
 - **Short cut:** *Instead of (2), (3), and (4), press **CODE** + **PRINT** (**P**).*

NOTES:

- Press **CANCEL** at any time to cancel the operation.
- The pitch will always be 10.

Preparing the Record for Merge Printing

RECORD	LABEL	DATA COPY	PRINT	ONE RECORD PRINT
				PRINT RECORD ON/OFF

The WP application allows you to prepare master documents that contain merge symbols associated with a label number (see “Creating a Document with Merge Symbols” on page 77). When you print such a master document, you will get as many copies as you have “enabled” records in the Merge file (see below to learn how to enable or disable a record). In the first copy, the word processor will merge the data of the first enabled record. In the second copy, the word processor will merge the data of the second enabled record, and so on. (When creating the master file, you should remember what kind of data you have in each label – or refer to a printout of the Merge file.)

An asterisk (*) to the left of a record indicates that the record is enabled. Since you may need to select only particular records for merge printing, the word processor allows you to toggle the records between enabled and disabled. (A new record is automatically enabled.)

1. Position the cursor on the record you want to enable or disable.
2. Press **MENU** to display the function menu.
3. Use **←** and **→** to select PRINT and press **RETURN** or **↓** to display the sub-menu.
 - **Accelerator:** Instead of (2), type “P”.
4. Use **↑** and **↓** to select PRINT RECORD ON/OFF and press **RETURN**. (If the record was enabled, it is now selected.)
 - **Accelerator:** Instead of (4), type “P”.

NOTES:

- Press **CANCEL** at any time to cancel the operation.
- The asterisks can also be used to select records that you want to print when you print the Merge file (see “Printing a Merge File” on page 125).

Instead of the above method, you can also move the cursor to the asterisk and press **(SPACE BAR)**. The asterisk of the selected record disappears. (Pressing **(SPACE BAR)** again will make the asterisk re-appear).

File Operations

Saving the Merge File



1. Press **FILE** from the MERGE screen. The following message appears:

Save file? Press RETURN to save, press CORRECT to abandon.

2. Insert a data diskette and press **RETURN** if you want to save the file. (Press **CORRECT** to erase the file.) If you press **RETURN**, the word processor asks you to enter a file name.

FILENAME:

3. Enter a file name and press **RETURN** to save the file. (The extension ".MRG" is automatically added to the file name.)

NOTE:

When the MERGE INDEX screen is displayed, press **CANCEL** or use the EXIT option on the menu to return to the MAIN MENU.

Retrieving a Merge File

1. Display the MERGE INDEX screen and insert the diskette containing the file you want to retrieve.
2. Move the cursor to the file you want to retrieve and press **RETURN**. The file appears on the MERGE screen.

Printing a Merge File

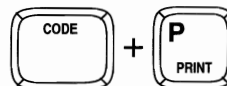

1. With the MERGE INDEX screen displayed, insert the diskette containing the file you want to print. When the file list appears, move the cursor to the file you want to print.
2. Press **MENU** to display the function menu.

EXIT COPY DELETE RENAME DISK DELETE PROTECT ON/OFF **PRINT**

3. Select PRINT and press **RETURN**.
 - **Accelerator:** Instead of (3), type "P".
 - **Short cut:** Instead of (2) and (3), press **CODE** + **PRINT** (**P**).

Using the Merge Function Menu



The other functions that are available on the function menu have already been explained in the "File Operation" section of the WP mode. When required to enter a file name, the extension ".MRG" is created and is visible on the INDEX screen.

Here is a list of the available functions:

Function	Description
EXIT	To return to the Main menu. You can also press CANCEL .
COPY	To copy a Merge file on the same diskette or on another diskette. The word processor allows you to enter a new file name for the copy. See "Copying a File" on page 70.
DELETE	To delete a Merge file. See "Deleting a File" on page 71.
RENAME	To rename a Merge file. See "Renaming a File" on page 72.
DISK DELETE	To delete all the files from the diskette. See "Deleting All Files" on page 74.
PROTECT ON/OFF	To write protect a diskette so that stored information cannot be changed or damaged. See "Diskette Write-Protect" on page 74.

Appendix

This section provides reference material for quick access to the information that you need. For example, if you do not remember the meaning of an error message, indicator, or symbol that appears on the screen, you will find a short definition and the page of this Manual where more information is provided.

Character Keys

Standard (I) and International (II) Keyboard

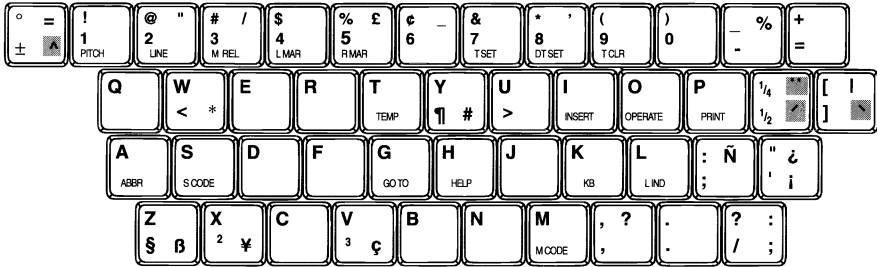

Keys with a single character (standard alphabet)
(Unshifted: small letter; shifted: capital letter)



Keys with more than one black character

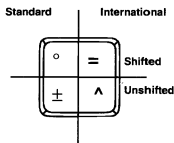

Keys with a green character (extra character obtained with the **CODE** key)

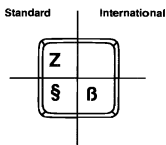

NOTE:

In the above illustration, dead keys are indicated with a small box.

Symbol (III) Keyboard



Keys with a single character
(same character when shifted or unshifted)



Keys with more than one character
(Unshifted: lower case; shifted: upper case)

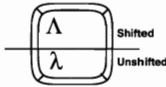

Keys with a third character
(extra character obtained with the **CODE** key)

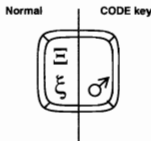

NOTES:

- In the above illustration, dead keys are indicated with a small box.
- To compose large mathematical symbols, use two dead characters and a blank space as the base character.

Examples: Σ (sum) and \int (integral)

Function Keys

The following list of function keys can be used as a quick reference guide. The list is organized in alphabetic order by function. The page(s) of this Manual where you can find more details about the operation are listed. For functions selected from a menu, see also "Function Menus" on page 135.

NOTE:

The functions marked with an asterisk () can be selected from many screens.*

Function	Function Key or Short Cut	Screen & Menu	Page
ABBREVIATED PHRASE LOAD		WP WRITE/EDIT (PHRASE)	82
ABBREVIATED PHRASE MAINTENANCE		WP WRITE/EDIT (PHRASE)	80
ABBREVIATED PHRASE (recall)	CODE + ABBR	WP WRITE/EDIT	79
ABBREVIATED PHRASE SAVE		WP WRITE/EDIT (PHRASE)	82
ALL DELETE (words)		USER DICTIONARY	113
BACKSPACE*	BACKSPACE		32
BACKSPACE 1	CODE + BS 1	TW	91
BOLD	CODE + B	TW (STYLE)	100
		WP WRITE/EDIT (STYLE)	51
CANCEL*	CANCEL		17
CAPS*	CODE + CAPS		18
CENTERING	CODE + F	TW (CTR/RMF)	102
		WP WRITE/EDIT (CTR/RMF)	47
COPY (block)	CODE + C	WP WRITE/EDIT (BLOCK)	33
COPY (data)	CODE + C	MERGE EDIT (DATA COPY)	122
COPY (file)*	CODE + C	INDEX screens	70
CORRECTION*	CORRECT		32,
			94
CURSOR KEYS*	↑ ↓ ← →		29

Function	Function Key or Short Cut	Screen & Menu	Page
DECIMAL TAB SET	CODE + DTSET	TW	98
		WP WRITE/EDIT	43
DELETE (abbreviated phrase)	CODE + D	ABBREVIATED PHRASE	81
DELETE (block)	CODE + D	WP WRITE/EDIT (BLOCK)	35
DELETE (file)*	CODE + D	INDEX screens	71
DELETE (record)	CODE + D	MERGE EDIT (RECORD)	123
DELETE (word)	CODE + D	USER DICTIONARY	113
DEMONSTRATION	CODE + D	MAIN MENU	16
DISK COPY		INDEX screen	72
DISK DELETE	CODE + L	INDEX screen	74
END*	CODE + END		30
EXIT*	CANCEL , FILE	ABBREVIATED PHRASE	81
		USER DICTIONARY	113
		INDEX SCREENS	64
EXPAND		TW (STYLE)	101
		WP WRITE/EDIT (STYLE)	53
EXPRESS BACKSPACE*	CODE + EXPR		30
FILE*	FILE		61
FOOTER		WP WRITE/EDIT (FORM)	58
GO TO*	CODE + GOTO		30
HEADER		WP WRITE/EDIT (FORM)	58
HELP*	CODE + HELP		11
HYPHEN*	-		26
HYPHEN SCAN		WP WRITE/EDIT (SEARCH)	40
HOME*	CODE + HOME		30
INDENT CLEAR	CODE + IND CLR	TW	99
		WP WRITE/EDIT	46
INSERT*	CODE + INSERT		31

Function	Function Key or Short Cut	Screen & Menu	Page
INSERT NEW RECORD	CODE + E	MERGE EDIT (RECORD)	122
JUSTIFY	CODE + OPERATE	TW	87
		WP WRITE/EDIT	50
KEYBOARD*	CODE + KB		54
LABEL LONGER	CODE + T CLR	MERGE EDIT (LABEL)	120
LABEL SHORTER	CODE + T SET	MERGE EDIT (LABEL)	120
LEFT MARGIN	CODE + L MAR	TW	88
		WP WRITE/EDIT	42
LINE INDENT	CODE + L IND	TW	99
		WP WRITE/EDIT	45
LINE OUT*	CODE + LINE OUT		32
LINE SPACING	CODE + LINE	TW	89
		WP WRITE/EDIT	56
LOAD (abbreviated phrase)		ABBREVIATED PHRASE	81
LOAD (file)*	RETURN	INDEX screens	64
LOAD (user dictionary)		USER DICTIONARY	114
MANUAL CORRECTION	CODE + CORRECT	TW	96
MARGIN RELEASE	CODE + M REL	TW	88
		WP WRITE/EDIT	42
MENU*	MENU		11
MERGE CODE	CODE + M CODE	WP WRITE/EDIT	77
MOVE		WP WRITE/EDIT (BLOCK)	36
OPERATE	CODE + OPERATE	TW	86, 87
PAGE BREAK	CODE + P BREAK	WP WRITE/EDIT	56
PAPER DOWN	CODE + P DOWN		27
PAPER INSERT	P INS		6
PAPER SIZE		WP WRITE/EDIT (FORM)	57
PAPER UP	CODE + P UP		27

Function	Function Key or Short Cut	Screen & Menu	Page
PARAGRAPH INDENT	CODE + P IND	TW	99
		WP WRITE/EDIT	46
PERMANENT BACKSPACE*	CODE + BACKSPACE		26
PERMANENT HYPHEN	CODE + -		26
PERMANENT SPACE	CODE + (SPACE BAR)		25
PITCH*	CODE + PITCH		55
PRINT (abbreviated phrases)	CODE + PRINT	ABBREVIATED PHRASE	81
PRINT (file)*	CODE + PRINT	INDEX screens	65
PRINT (one record)	CODE + PRINT	MERGE EDIT (PRINT)	123
PRINT (page)	CODE + PRINT	WP WRITE/EDIT (PAGE PRINT)	65
RELOCATION*	CODE + RELOC		30
RENAME*	CODE + R	INDEX screens	72
REPLACE		WP WRITE/EDIT (SEARCH)	39
RETURN*	RETURN		17
RIGHT MARGIN	CODE + R MAR	TW	88
		WP WRITE/EDIT	42
RIGHT MARGIN FLUSH	CODE + R	TW (CTR/RMF)	103
		WP WRITE/EDIT (CTR/RMF)	49
SAVE (abbreviated phrase)		ABBREVIATED PHRASE	81
SAVE (file)*	FILE		61
SAVE (user dictionary)		USER DICTIONARY	114
SCALE LINE ON/OFF		WP WRITE/EDIT (FORM)	24
SEARCH		WP INPUT EDIT (SEARCH)	37
SHIFT*	SHIFT		18
SHIFT LOCK*	CAPS		18
SPACE*	(SPACE BAR)		25

Function	Function Key or Short Cut	Screen & Menu	Page
SPELL	CODE + SPELL	TW (SPELL)	111
		WP WRITE/EDIT (SPELL)	108
STOP CODE	CODE + S CODE	WP WRITE/EDIT	68
TAB	TAB		44, 98
TAB CLEAR	CODE + T CLR		44, 98
TAB SET	CODE + T SET		43, 98
TEMPORARY FILE	CODE + TEMP	WP WRITE/EDIT	35
TYPEWRITER/WORD PROCESSOR	TW/WP		84
UNDERLINE	CODE + U	TW (STYLE)	100
		WP WRITE/EDIT (STYLE)	52
USER DICTIONARY MAINTENANCE		TW (SPELL)	112
		WP WRITE/EDIT (SPELL)	112
USER DICTIONARY LOAD		TW (SPELL)	114
		WP WRITE/EDIT (SPELL)	114
USER DICTIONARY SAVE		TW (SPELL)	115
		WP WRITE/EDIT (SPELL)	115
WORD OUT*	WORD OUT		32

Function Menus

The following table can be used as a quick guide for the functions available from the function menus. The characters printed in bold indicate the accelerators.

WP WRITE/EDIT Screen

Main Menu	Sub-menu	Short-cut Key	Page
STYLE	BOLD	CODE + B	51
	UNDERLINE	CODE + N	52
	EXPAND		53
BLOCK	COPY	CODE + C	33
	DELETE	CODE + D	35
	MOVE	CODE + E	36
CTR/RMF	CENTERING	CODE + F	47
	RIGHT MARGIN FLUSH	CODE + R	49
SPELL	SPELL CHECK	CODE + SPELL	108
	USER DICTIONARY MAINTENANCE		112
	USER DICTIONARY LOAD		114
	USER DICTIONARY SAVE		115
PHRASE	MAINTENANCE		80
	LOAD		82
	SAVE		82
FORM	PAPER SIZE		57
	HEADER		58
	FOOTER		58
	SCALE LINE ON/OFF		24
SEARCH	SEARCH		37
	REPLACE		39
	HYPHEN SCAN		40
PAGE PRINT		CODE + PRINT (P)	65

ABBREVIATED PHRASE Screen

Menu	Short-cut Key	Page
EXIT	FILE or CANCEL	81
PRINT	CODE + PRINT (P)	81
DELETE	CODE + D	81
LOAD		81
SAVE		81

USER DICTIONARY Screen

Menu	Short-cut Key	Page
EXIT	FILE or CANCEL	113
DELETE	CODE + D	113
ALL DELETE		113
LOAD		113
SAVE		113

INDEX Screens

Menu	Short-cut Key	Page
EXIT	CANCEL	64
COPY	CODE + C	70
DELETE	CODE + D	71
RENAME	CODE + R	72
DISK COPY		72
DISK DELETE	CODE + L	74
PROTECT ON/OFF		74
PRINT	CODE + PRINT (P)	65

TW Application

Main Menu	Sub-menu	Short-cut Key	Page
STYLE	BOLD	CODE + B	100
	UNDERLINE	CODE + N	100
	EXPAND		101
CTR/RMF	CENTERING	CODE + F	102
	RIGHT MARGIN FLUSH	CODE + R	103
SPELL	SPELL CHECK	CODE + SPELL	111
	USER DICTIONARY MAINTENANCE		113
	USER DICTIONARY LOAD		113
	USER DICTIONARY SAVE		113

Mail Merge

Main Menu	Sub-menu	Short-cut Key	Page
RECORD	INSERT	CODE + E	122
	DELETE	CODE + D	123
LABEL	LABEL LONGER	CODE + T CLR	120
	LABEL SHORTER	CODE + T SET	120
DATA COPY		CODE + C	122
PRINT	ONE RECORD PRINT	CODE + PRINT (P)	123
	PRINT RECORD ON/OFF		124

Symbols

The following lists describe the symbols that appear on the screen. Two kinds of symbols exist:

- Symbols displayed on the scale
- Symbols displayed in the text that are never printed

Symbols Displayed on the Scale

Symbol	Meaning	Page
L	Position of the left margin	42
R	Position of the right margin	42
T	Position of a tab stop	43
D	Position of a decimal tab stop	43
⏏	Beginning of the hot zone	25
0, 1, 2,...	Absolute position from the left edge of the paper	22

Symbols Displayed in the Text

All the following symbols are displayed in the text in WP mode (unless otherwise specified).

Symbol	Meaning	Page
⏏	CENTERING BETWEEN MARGINS: displayed at the left of the centered string when the centering function is activated	47
⏏	CENTERING BETWEEN TABS: displayed at the left of the centered string when the centering function is activated	48
⏏	FORMAT CHANGE: displayed in the dead column, in front of the first line of a reformat- ted paragraph	22
⏏	INDENT CLEAR: displayed at the end of an indented paragraph when CODE + IND CLR is pressed	46

Symbol	Meaning	Page
↵	LINE FEED: displayed at the end of a paragraph when RETURN is pressed	17
M	MERGE CODE: displayed at the cursor position when CODE + M CODE (M) is pressed	77
⏴	PAGE BREAK: displayed at the end of a paragraph when CODE + P BREAK is pressed	56
→	PARAGRAPH INDENT: displayed at the left of a tab stop when the cursor has been moved with CODE + P IND	46
←·	PERMANENT BACKSPACE: displayed between the base character and the superimposed character when CODE + BACKSPACE is pressed in TW mode (L/L, centering, right margin flush, and decimal tab)	92
⋮	PERMANENT SPACE: displayed at the cursor position when CODE + (SPACE BAR) is pressed	25
←	RIGHT MARGIN FLUSH: displayed at the left of the aligned string when the right margin flush function has been activated	49
S	STOP SYMBOL: displayed at the cursor position when CODE + S CODE (S) is pressed	68
→	TAB: displayed at the left of a tab stop when the cursor has been moved with TAB	44

Indicators

The following list describes the indicators that appear on top of the screen. In the following list, the “X’s” stand for variable indication.

Indicator	Meaning	Page
AUT	On when the auto return function of the TW mode is activated	86
BLD	On when the bold function is activated	51, 100
CAPS	On if the keyboard is in caps lock mode	18, 90
COL:XXX	Number of the current column	55
CNT	On when the continuous underline function is activated	52, 100
CTR	Displayed when the centering function is on in TW mode	102
DEAD:XX	Displays the dead character when the cursor is on the base character (WP mode)	28
DTAB	Displayed when the decimal tab function is on in TW mode	98
EXP	On when the expand function is activated	53, 101
INS	On when the insert mode is activated	31
JST	On when the justify function is activated	50, 87
KB:XX	Current keyboard selection (I, II, or III)	54, 90
L:XXX	Number of the current line	56
LABEL:XX	Number of the current label	118
L.SP:X.X	Current line spacing (1.0, 1.5, or 2.0)	56
M.C	On when the manual correction function of the TW mode is activated	96
MRG:XX	Prompts you to specify the label number of the information to appear at the current position in a merged document	77
P:XX	Number of the current page	56

Indicator	Meaning	Page
P BS:X	Displays the superimposed character when the cursor is on the base character (WP mode)	26
P IND	Displayed when the paragraph indent function is on in TW mode	99
PITCH:XX	Current pitch (10, 12, or 15)	55, 89
RECORD:XX	Number of the current record	118
REMAIN	In TW mode: Indicates the number of characters which can be typed until the right margin is reached	85
	In other screens: Indicates the remaining free space on the diskette	60
RMF	Displayed when the right margin flush function is on in TW mode	103
SHIFT	On if the keyboard is in uppercase mode	18, 90
TOTAL WORDS:XX	Indicates the total number of words in the user dictionary.	112
SP	On when the Spell Checker is activated	108
WRD	On when the word underline function is activated	52, 100
XXXXXXXX	Displayed at the upper-left corner of the WRITE/EDIT screen: Name of the current file	21

Error Messages

Please consult the following table when an error message appears.

Message	Cause	Remedy
Memory full.	You attempted an operation that would require more memory than the total limit of 32 kilobytes. The merge file length may have exceeded the maximum length of 7 kilobytes.	Delete some parts of the text using BACKSPACE , CORRECT , WORD OUT , CODE + LINE OUT , or the block delete function. You may also try to copy a smaller block.
Unidentified disk error. Insert another and press RETURN.	Defective diskette.	Consult your dealer.
Initialize? Press Y (yes) or N (no).	You attempted to copy an uninitialized source diskette.	Initialize the diskette. (This will erase any files previously stored on the diskette.)
Insert disk and press RETURN.	The diskette is not inserted when you start a read operation, or the diskette is removed during read or write operation (a message was telling you to wait).	Insert the diskette and press RETURN . In future, please avoid removing or inserting a diskette while prompted to wait.
Incorrect disk. Insert another and press RETURN.	The selected file cannot be found on the inserted diskette (you changed the diskette so that the WP INDEX screen and the inserted diskette do not match).	Press CANCEL or reinsert the correct diskette and press RETURN .
Disk is write protected. Press CODE + SPACE to release and press RETURN to retry.	You are using a soft write-protected diskette.	Use another diskette or disengage the soft protection.
Check printer.	Malfunction of the printer mechanism.	Consult your dealer.
Check disk.	Malfunction of the disk drive.	Consult your dealer.

Message	Cause	Remedy
ROM down.	Malfunction detected in your word processor's Read Only Memory.	Consult your dealer immediately.
RAM down.	Malfunction detected in your word processor's Random Access Memory.	Consult your dealer immediately.
Cover open.	The acoustic cover is open.	Close the acoustic cover firmly.

Troubleshooting Chart

Your word processor has been precision-manufactured to give you years of trouble-free use. In the rare case that trouble does happen, you will probably be able to find the solution in the table below. If you cannot, please do not attempt to repair the word processor yourself. Instead, please contact your dealer.

Trouble	Remedy
Nothing works after the word processor has been switched on.	Check that the power cord is plugged in. Check that the acoustic cover is firmly closed.
Printout is impossible or difficult to read.	Check that the cassette daisy wheel is inserted correctly. Check that the cassette ribbon is positioned correctly. Check that the installed daisy wheel matches the selected KEYBOARD.
Correction on paper is impossible.	Check to see if the correction tape has run out and replace it if necessary. Check that the correction tape is installed properly. Check that the correction tape you have purchased corresponds to the cassette ribbon you are using.
All seems normal after the word processor has been switched on, but nothing is displayed.	Adjust the brightness controller.
Printed and displayed characters do not match.	Check that the installed daisy wheel matches the selected KEYBOARD. Check that the PAUSE FOR KEYBOARD CHANGE is selected as NO on the Print Menu screen.
Diskette operation is not possible.	The diskette has been damaged, or a television set is located too close to the drive. Try with another diskette and/or move the word processor. The diskette may be a "HD" diskette. Use "DD" diskette only.

Accessories

Changing the Daisy Wheel Cassette

This word processor uses Brother daisy wheel cassettes, which are print elements housed in clear plastic. This ensures that fingers will never touch the type-face, thereby reducing the risk of damage. One wheel comes with the word processor. Others providing different type sizes, styles, and character sets are also available. (See "Compatible Accessories" on page 150.)

NOTE:

If the cassette is not inserted properly or the daisy wheel is not locked in position, there may be no printout, the printout may be gibberish, or the wheel may break.

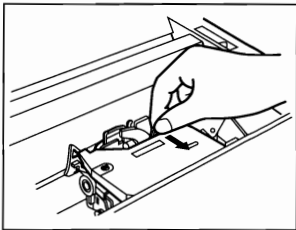

Lift the acoustic cover, and then release the daisy wheel by pulling the lever toward you.

NOTE:

It is not necessary to remove the ribbon when replacing the daisy wheel.

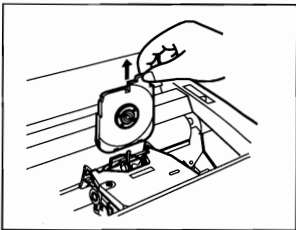

Remove the cassette by the "ear" on the top right.

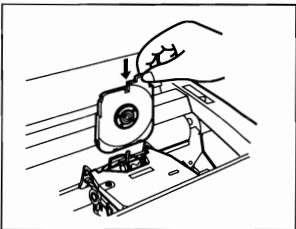

Slide the new cassette into the slot.

NOTE:

Use only Brother Cassette Daisy Wheels and make sure the cassette is not inserted backwards. (The "ear" should be on the right.)

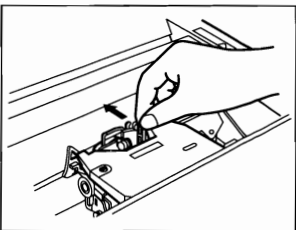

Be sure to slide the lever back to its original position to lock the daisy wheel in place. Press the lever forward once more to assure the daisy wheel is properly set, and close the acoustic cover.

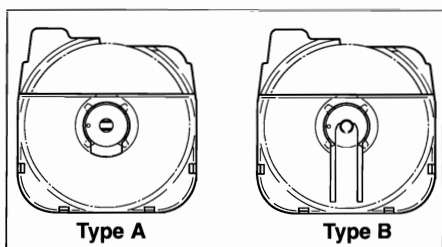

NOTE:

Please check the shape of your daisy wheel cassette before replacing the daisy wheel. The daisy wheel cassette type B cannot be used with this word processor.

Changing Ribbons

This word processor uses ribbons enclosed in handy cassettes. Two types of ribbons are available, Brother Correctable Ribbon model #1030 and Brother Nylon Ribbon model #1032.

NOTE:

Use only Brother ribbons. Ribbons of different brands, or Brother ribbons other than models #1030 and #1032 will not fit into the word processor, or could affect the operation of the word processor. (See "Compatible Accessories" on page 150.)



Turn the power on and use **TW/WP** to switch the word processor to the Typewriter application.

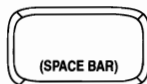

Use **(SPACE BAR)** and **BACKSPACE** to move the carrier to the center of the platen.



Lift the acoustic cover.

NOTE:

It is not possible to move the carrier while the acoustic cover is open. Close the acoustic cover to re-position the carrier.

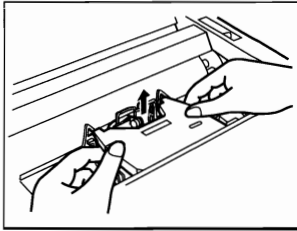

Grasp the cassette with both hands, raise the front end and lift out.

NOTE:

The amount of ribbon remaining can be checked through the viewing hole on the right side of the cassette.

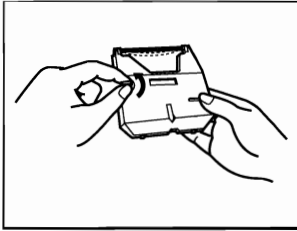

Turn the feed knob on the left side of the new cassette counterclockwise to take up any slack.

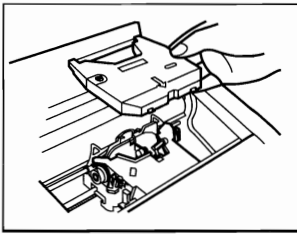

Align the arrow on the cassette with the center of the cassette holder, slide the ribbon between the guides, and use both hands to ease the cassette into the holder.

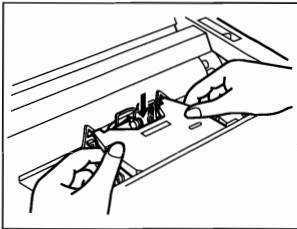

Gently press down on the front of the cassette until it clicks into place. Once again turn the feed knob counterclockwise to take up any slack. Close the acoustic cover.

Changing Correction Tapes

This word processor uses correction tape to correct typewriter errors. Two types of correction tapes are available, Brother Lift off tape model #3010 (for use with the correctable film ribbon) and Brother Cover up tapes model #4010 (for use with the nylon ribbon). (See "Compatible Accessories" on page 150.)



Turn the power on and use **TW/WP** to switch the word processor to the Typewriter application.



Use **(SPACE BAR)** and **(BACKSPACE)** to move the carrier to the center of the platen.

Lift the acoustic cover and remove the ribbon cassette, if installed. (See "Changing Ribbons" on page 146.)

NOTE:

It is not possible to move the carrier while the acoustic cover is open. Close the acoustic cover to re-position the carrier.

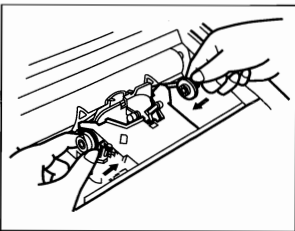
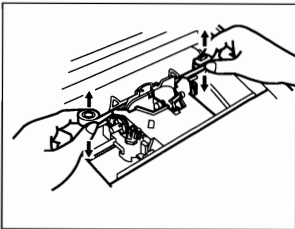
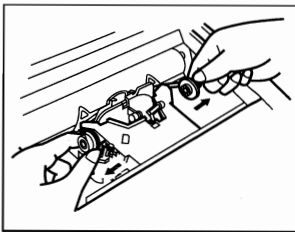

Grasp the spools with your thumbs in the positions shown and pull them off their mounts.

Bring the tape back to a position parallel with the platen and then lift it up and out.

Pass the new tape through the left guide, behind the ribbon guide, and out through the right guide. The rough side of the tape should face the platen.

Mount the feeder spool on the pin on the left and the take-up spool on the pin on the right.

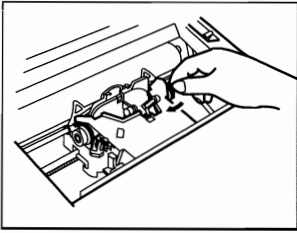

Turn the take-up spool counterclockwise until a small amount of white tape has been wound around it.

Replace the ribbon cassette and close the acoustic cover.

Compatible Accessories

NOTE:

Obtain ribbon cassettes, correction tape, daisy wheel cassettes and diskettes from your nearest authorized dealer. Brother cannot be responsible for difficulties caused by the use of unauthorized accessories.

Starter Kits and Accessories

Name	Description
SK-100	3 Correctable Film Ribbons 1 Script 1012 Daisy Wheel 1 Lift-off Correction Tape
SK-150	3 Correctable Film Ribbons 2 diskettes 2 Lift-off Correction Tapes
MFD-60	A box of ten 3.5" diskettes

Cassette Ribbons / Correction Tapes

Name	Description
1030	Correctable Film Ribbon
1230	Correctable Film Ribbon (2 packs)
1032	Nylon Ribbon
3010	Lift-Off Correction Tape (2 pcs.) to be used with 1030, 1230 ribbons
4010	Cover up Correction Tape (2 pcs.) to be used with 1032 ribbons

Daisy Wheel Cassettes

Name	Pitch	Type
M401	10	Pica 10 (Standard Pica)
M402	10, 12	Prestige 1012
M403	12	Elite 12 (Standard Elite)
M405	10, 12	Script 1012
M408	10	Grande 10
M409	10, 12	Quadro 1012
M411	10	Brougham 10
M412	12	Brougham 12
M414	10, 12	Prestige Italic 1012
M415	10	OCR-B 10
M416	10	OCR-A 10
M417	12	Letter Gothic 12
M410	15	Quadro 15
M413	15	Brougham 15
M461	10	Brougham 10 (International)
M452	10, 12	Prestige 1012 (International)
M460	15	Quadro 15 (International)

NOTE:

"1012" indicates that the same daisy wheel can be used for both Pica and Elite.

Daisy Wheel Samples

Pica (1/10") Pitch

Prestige 1012	ABCDEFGHIJKLMN OPQRSTUVWXYZ abcdefghijklmnopqr stuvwxyz 1234567890
Prestige Italic 1012	<i>ABCDEFGHIJKLMN OPQRSTUVWXYZ abcdefghijklmnopqr stuvwxyz 1234567890</i>
Script 1012	<i>ABCDEFGHIJKL MNOPQRST UVWXYZ abcdefghijklmnopqr stuvwxyz 1234567890</i>
Quadro 1012	ABCDEFGHIJKLMN OPQRSTUVWXYZ abcdefghijklmnopqr stuvwxyz 1234567890
Pica 10	ABCDEFGHIJKLMN OPQRSTUVWXYZ abcdefghijklmnopqr stuvwxyz 1234567890
Grande 10	ABCDEFGHIJKLMN OPQRSTUVWXYZ ABCDEFGHIJKLMN OPQRST UVWXYZ 1234567890
Brougham 10	ABCDEFGHIJKLMN OPQRST UVWXYZ abcdefghijklmnopqr stuvwxyz 1234567890
OCR-B 10	ABCDEFGHIJKLMN OPQRST UVWXYZ abcdefghijklmnopqr stuvwxyz 1234567890

Elite (1/12") Pitch

Prestige 1012	ABCDEFGHIJKLMN OPQRSTUVWXYZ abcdefghijklmnopqr stuvwxyz 1234567890
Prestige Italic 1012	<i>ABCDEFGHIJKLMN OPQRST UVWXYZ abcdefghijklmnopqr stuvwxyz 1234567890</i>
Script 1012	<i>ABCDEFGHIJKL MNOPQRST UVWXYZ abcdefghijklmnopqr stuvwxyz 1234567890</i>
Quadro 1012	ABCDEFGHIJKLMN OPQRST UVWXYZ abcdefghijklmnopqr stuvwxyz 1234567890
Elite 12	ABCDEFGHIJKLMN OPQRST UVWXYZ abcdefghijklmnopqr stuvwxyz 1234567890
Brougham 12	ABCDEFGHIJKLMN OPQRST UVWXYZ abcdefghijklmnopqr stuvwxyz 1234567890
Letter Gothic 12	ABCDEFGHIJKLMN OPQRST UVWXYZ abcdefghijklmnopqr stuvwxyz 1234567890

Micron (1/15") Pitch

Quadro 15	ABCDEFGHIJKLMN OPQRST UVWXYZ abcdefghijklmnopqr stuvwxyz 1234567890
Brougham 15	ABCDEFGHIJKLMN OPQRST UVWXYZ abcdefghijklmnopqr stuvwxyz 1234567890

Pica (1/10") Pitch

Symbol 10

① ^ ˇ ˆ ˘ ˙ ˚ ˛ ˜ ˝ ˞ ˟ ˠ ˡ ˢ ˣ ˤ ˥ ˦ ˧ ˨ ˩ ˪ ˫ ˬ ˭ ˮ ˯ ˰ ˱ ˲ ˳ ˴ ˵ ˶ ˷ ˸ ˹ ˺ ˻ ˼ ˽ ˾ ˿ ˿
 1 2 3 4 5 6 7 8 9 0 _ , ' Γ Δ + ⊖ → T ≡ † ‡ § { + ∇ Σ Φ < Λ Π ∩ § Ω () ' † ‡ ≡ Ψ α ∞ ∪ ∩ √ ∫ ∫
 ≤ ≥ ∂ ∂ - ∅ =



Note:

"1012" indicates that the same daisy wheel can be used for both Pica and Elite.
 Download from www.Somanuals.com. All Manuals Search And Download.

Specifications

Display	LCD, 4lines x 80 columns
Keyboard	65 keys Auto repeat function 3 selectable character sets
Printer Daisy wheel Paper capacity Typing capacity Copy capacity Typing speed Character pitches Line spacing Printing direction Ribbons Correction tapes	Built-in daisy wheel printer Cassette (96 characters) 326.9 mm (12.87") 228.6 mm (9") Original + 4 copies 13 characters/second 10, 12, 15 (90, 108, 135 characters/line max.) 1.0, 1.5, 2.0 bi-directional Correctable film (approx. 50,000 characters) Nylon (approx. 500,000 characters) Lift off & cover-up (up to 1,400 characters)
Memory Correction memory Internal memory	One line 64 kilobytes
General Voltage Weight Dimensions	110 ~ 120V 5.8 kg 16.4" (W) x 5.35" (H) x 17.2" (D) 417 mm (W) x 136 mm (H) x 437.5 mm (D)

Glossary

ABBREVIATED PHRASE	To increase your typing speed, you can store frequently used strings in a special abbreviated phrase file and recall any string by merely typing its abbreviation (which has been stored along with the string).
ACCELERATOR	Instead of selecting a function from a menu with  or  and then pressing  to activate the function or to display a submenu, press the letter keys that appear in bold on the menu. This character is called an accelerator.
BACKUP	A copy of all the data on a diskette that you keep in case your original data is damaged.
BLOCK OPERATIONS	The block operations on this word processor allow for on-screen cutting & pasting tasks. They include block copy, move and delete. You may even copy a block of the document into a temporary file.
BOLDFACE	Boldface characters are thicker than normal characters.
CENTERING	A layout function that allows you to automatically center a line between margins or tabs.
CORRECTION MEMORY	A special memory used by the word processor to temporarily store the text of the current line in the TW mode. Since the word processor knows the contents of the current line as well as their position on the paper, corrections can be carried out without retyping the wrong character. The correction memory is cleared as soon as the carrier advances to the next line.
CURSOR	1) A blinking box used to select a position on the screen; 2) a block-shaped illuminated area used to select menu items by highlighting the item in reverse image.
DAISY WHEEL	A removable plastic wheel with spokes extending out from the center that is used for printing on this word processor.
DEAD KEY	A key that produces a character but does not move the cursor or carrier one position to the right. Dead keys are usually used to type the accent marks used in such languages as French, German, and Spanish.
DECIMAL TAB	A special tab used to neatly align a column of numbers the same way you align them when carrying out a sum manually.

DISK DRIVE	The mechanism which writes data to and reads data from the diskette.
DISKETTE	A thin, flexible magnetic-coated diskette on which computer data can be stored.
DISPLAY	The LCD display shows the setting indicators, the text you are typing, function menus, and messages.
DOUBLE COLUMNS	This function allows you to print your document PRINTING in two columns. On the screen, the text is displayed continuously in one column.
EDITING	Editing a text simply means modifying it. With this word processor, you can edit a line in L/L mode or the entire document in WP mode. You can also edit user dictionaries, abbreviated phrase files, and merge data files.
ELITE	One of the available pitches on this word processor. Elite pitch corresponds to 12 characters per inch. When you select this pitch, make sure that the daisy wheel in use bears the indication "12".
EXPAND	A Word Processing and Typewriter function that changes the appearance of text by inserting a space after each character.
EXPRESS BACKSPACE	A Typewriter and Word Processing function that moves the carrier or cursor quickly to the left margin.
EXTENSION	A period followed by a maximum of three characters, that are added to the end of a file name to identify in which mode the file was created. This word processor adds automatically the extension ".MRG" to your merge file names.
FILE	The unit in which data is stored on the diskette, for example, a single Word Processing document.
FOOTER	A footer is a line of text that is printed at the bottom of each page. With this word processor, the footer includes an automatic page numbering function.
FORMAT	<ol style="list-style-type: none"> 1) The way a diskette is organized for storing files. This word processor uses 240K Brother original format. 2) The visual arrangement of text on a page, determined by such factors as margin and tab settings, justification, etc.
FORMATTING	A process by which the system divides a new diskette into sections that organize the storage of your files.
FRACTIONAL BACKSPACE	A Typewriter function that moves the carrier backwards by 1/60th of an inch.

PLATEN	The rubber roller driving the paper up and down. The movement of the platen can be controlled with the keyboard, or manually, by turning the platen knob. We recommend that you never type anything without inserting paper to prevent the platen from becoming dirty.
RAM	Random Access Memory – a memory you can write in or read from. All the information you input from the keyboard is stored in this type of memory. The RAM is always cleared when you turn the power off.
RECORD	A record is an entry of a Merge file. It may contain different items but must fit on a single line.
REDUNDANCY CHECK	Redundancy check is a function of the Spell Checker. It detects repeated words.
RELOCATION	The relocation function automatically moves the carrier or cursor to the end of the current line after correction has been carried out in the middle of the line.
REVERSE IMAGE	A way of highlighting text by reversing the screen image so that text appears dark and the area surrounding it appears light.
RIGHT MARGIN FLUSH	A layout function that allows you to automatically align the text of a line with the right margin. This is useful, for instance, when you type the date on a letter.
ROM	Read Only Memory. This kind of memory is where the manufacturer stored the software of the word processor. This permanent memory is not cleared when you turn the power off.
SCALE	The line at the top of the display that shows the horizontal position of the cursor as well as the position of the margins, hot zone, and tab settings. It is displayed when SCALE LINE ON is selected.
SCROLL	When all data cannot fit on the screen, changes the displayed data such that as old data disappears at one edge, new data appears at the opposite edge.
SEARCH & REPLACE	The search and replace function automatically scans the document and stops at each occurrence of a specified word. It allows for easy replacement of a word.
SHORT-CUT KEYS	Keys that are used to activate a function quickly, without displaying the function menu.
SOFT HYPHEN	A hyphen typed to divide a word in the hot zone that disappears if subsequent revision or reformatting moves the word out of the hot zone.

SPELL CHECKER	A sophisticated package of functions including a spell checker program with a user dictionary. The spell checker function automatically checks your text and warns you when a mistake is detected (misspelled or double word).
STATUS LINE	The area at the top of the screen showing the name of the file you are working on, the current page, line, and column number of the cursor, number of characters remaining on the line, and the current settings such as Keyboard, Pitch, and Line Spacing.
STOP SYMBOL	Stop symbols can be inserted in your file in order to automatically interrupt printing. When printing is interrupted, you are free to type additional text on the paper. That text will not be stored in the memory.
SUBMENU	A menu that “drops down” from a function menu to display a list of additional options related to your function menu choice.
SUBSCRIPT	A character that must be printed at a position slightly lower than normal characters. Used to type mathematical expressions or chemical formulas.
SUPERIMPOSED	A character like “¥” is not directly available CHARACTERS on the keyboard, but can be obtained by superimposing “Y” and “=”.
SUPERSCRIPT	A character that must be printed at a position slightly higher than normal characters. Used to type mathematical expressions (exponents).
SYMBOL KEYBOARD	The Keyboard setting that offers mathematical symbols and Greek characters (KB:III).
TOP COVER	The clear plastic cover that protects the inside of the word processor and decreases printer noise.
TYPE MODE	An option in Typewriter mode in which the characters you type are printed immediately rather than being displayed on the screen.
UNDERLINE	With the word processor, characters can be automatically printed with an underline.
USER DICTIONARY	A list of words that are not in the Spell Checker standard dictionary, which the Spell Checker consults when checking spelling in your document.
WORD OUT	The WORD OUT function allows you to quickly erase the word the carrier or cursor is on, from the current position to the beginning of the word.

WORD WRAP

When displaying a file, a word that cannot fit on a line is automatically moved to the next line.

WRITE-PROTECT

Protecting a diskette from accidental erasure by setting write-protect ON or OFF from the INDEX screen.

Index

A

Abbreviated Phrase Maintenance 80
Abbreviated Phrase Memory 79
Abbreviated Phrases 79
Accelerator 23
Accents 28, 93
Accessories 145, 150
Acoustic Cover 3
Auto Mode 84
Automatic Correction 94
Automatic Return 86
Automatic Save Function 63
Auto-repeat Keys 9

B

Backing up a Diskette 14
Base Character 28
Block Copy 33, 34
Block Delete 35
Block Move 36
Bold 51, 100
Bottom Margin 57
Bottom Space 57
Brightness Controller 3

C

Cancel Function 17
Capital Lock Function 90
Caps Lock Function 18
Carrier 3
Carrying Handle 3
Cassette Daisy Wheel 3
Cassette Ribbon 3
Centering between Margins 47, 102
Centering between Tabs 48, 102
Character Keys 9, 128
Character Set 54
Cleaning 8
Clearing Tabs 44, 98
Copying a File 70
Copying Data 122

Correction Tape 3
Correction Tapes 147, 150
Corrections 94
Cursor Keys 88

D

Daisy Wheel Lock Lever 3
Daisy Wheels 28, 54, 68, 145, 151,
152
Data Merge 76
Dead Keys 28, 93, 128, 129
Decimal Tabs 43, 97
Deleting a File 71
Deleting a Record 123
Deleting All Files 74
Deleting Text 31
Disk Copy 72
Disk Drive 3
Disk Eject Button 3
Disk Write-Protection 13
Diskette Format 14
Diskette Shutter 13
Diskettes 12
Distance between Margins 43
Double Column Printing 66, 75
Double Words 108, 110

E

Elite 55
Ending Page 66
Error Messages 142
Expand 53, 101
Express Backspace 30, 92
Extra Characters 27

F

Faulty Operation 8
File Name 63
File Operation 60
File Printing 65
Footer 57, 58

Foreign Language Words 107
Foreign Languages 54, 93
Format Change Symbol 42
Fractional Backspace 91
Function Keys 10, 130
Function Menu 23
Function Menu Key 11
Function Menus 135

G

Glossary 154
Go To Function 30, 113
Greek Characters 54
Green Indication on Keys 10, 27

H

Header 57, 58, 66
Help Key 11
Horizontal Positioning 55
Hot Zone 25, 85
Hyphen Scan 40
Hyphens 26

I

Indicators 140
Initializing New Diskettes 14
Insert Mode 31
Inserting Paper 6, 88
Inserting Text 31
Interference 8
International Keyboard 9, 27, 54, 90,
128

J

Joining Paragraphs 32
Justification 25, 50
Justify Mode 84, 87

K

Keyboard 3
Keyboard Control Keys 9
Keyboard Layout 9
Keyboard Switching 54, 90

L

Label 117
LCD 3
Line Indent 45, 99
Line Out 32, 95
Line Spacing 56, 89
Line-by-Line Mode 84, 86
Loading a User Dictionary 114
Loading an Abbreviated Phrase File
82

M

Mail Merge Application 15, 117
Main Menu 15
Malfunction 8
Manual Corrections 96
Manual Return 85
Margins 42, 88
Mathematical Symbols 54
Merge Printing 66, 78, 124
Merge Symbols 75, 76, 77
Message Line 23
Micron 55

N

Normal Backspace 91
Number of Copies 66

O

On-Screen Symbols 17
Overheating 8
Overwrite (file) 62
Overwrite Mode 31

P

Packing Pieces 4
Page Breaks 17, 28, 56
Page Numbering 59
Page Printing 65
Paper Release Lever 3
Paper Size 57
Paper Support 3, 6
Paper Width 55

Paragraph Indent 46, 99
Pause for Keyboard Change 66
Permanent Backspace 26, 92
Permanent Hyphens 26
Permanent Spaces 25, 45, 53
Pica 55
Pitch 55, 75, 89
Platen Knob 3
Power Cord 5
Power Cord Compartment 3
Power Failure 63
Power Switch 3, 5
Precautions 8
Printing a File 65, 125

R

Record 117
Relocation 30, 95
Renaming a File 72
Retrieving a File 64, 125
Return Function 17
Ribbons 146, 150
Right Margin Flush 49, 103

S

Saving a File 61, 125
Saving the Abbreviated Phrase Memory 82
Saving the User Dictionary 115
Scale 22
Scale Cursor 22
Scale ON/OFF 24
Search and Replace 39
Search String 38
Self-Demonstration 16
Shift Lock Function 18, 90
Shift Mode 18
Short Cut 24
Soft Space 25
Space between Columns 66
Spaces 25
Special Symbols 93
Specifications 153
Spell Checker 106
Splitting Paragraphs 32

Standard Keyboard 9, 54, 90, 128
Starter Kits 150
Starting Page 66
Status Line 21, 85
Stop Symbols 68
Style 51, 100
Sub-menu 23
Subscripts 27, 93
Superimposed Characters 26
Superscripts 27, 93
Suspect Word 108, 110
Symbol Keyboard 9, 54, 90, 129
Symbols 138

T

Tabs 43, 97
Temporary File 34, 35, 72
Temporary Left Margin 46
Text Area 22, 57
Text Cursor 22, 29
Text Emphasis 51, 100
Thunderstorms 8
Top Margin 57
Top Space 57
Transporting the Machine 6
Troubleshooting Chart 144
Typewriter Application 15, 83
Typewriter Mode Screen 85

U

Underline 52, 100
User Dictionary 107, 112
User Dictionary Maintenance 112

V

Vertical Layout 56

W

Word Out 32, 94
Word Processing Application 15, 19
Word Spell 107
Word Wrap 17, 25

brother®

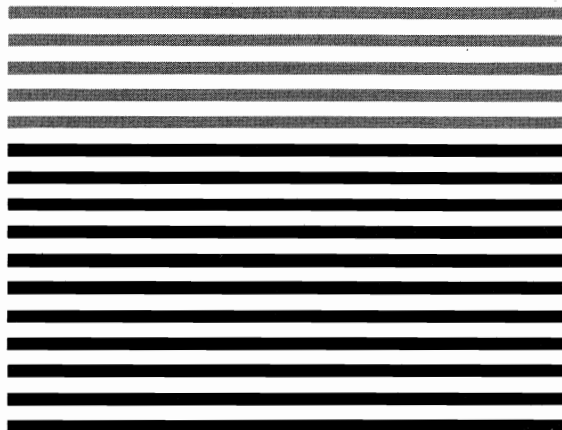

US0082001
Printed in U.S.A.

Free Manuals Download Website

<http://myh66.com>

<http://usermanuals.us>

<http://www.somanuals.com>

<http://www.4manuals.cc>

<http://www.manual-lib.com>

<http://www.404manual.com>

<http://www.luxmanual.com>

<http://aubethermostatmanual.com>

Golf course search by state

<http://golfingnear.com>

Email search by domain

<http://emailbydomain.com>

Auto manuals search

<http://auto.somanuals.com>

TV manuals search

<http://tv.somanuals.com>