

SEH100TX-22 100BASE-T INTELLIGENT STACKABLE HUB USER'S GUIDE

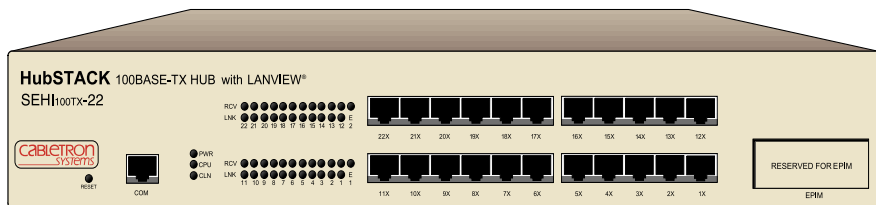

CABLETRON
systems
The Complete Networking Solution™

NOTICE

Cabletron Systems reserves the right to make changes in specifications and other information contained in this document without prior notice. The reader should in all cases consult Cabletron Systems to determine whether any such changes have been made.

The hardware, firmware, or software described in this manual is subject to change without notice.

IN NO EVENT SHALL CABLETRON SYSTEMS BE LIABLE FOR ANY INCIDENTAL, INDIRECT, SPECIAL, OR CONSEQUENTIAL DAMAGES WHATSOEVER (INCLUDING BUT NOT LIMITED TO LOST PROFITS) ARISING OUT OF OR RELATED TO THIS MANUAL OR THE INFORMATION CONTAINED IN IT, EVEN IF CABLETRON SYSTEMS HAS BEEN ADVISED OF, KNOWN, OR SHOULD HAVE KNOWN, THE POSSIBILITY OF SUCH DAMAGES.

© Copyright 1996 by Cabletron Systems, Inc., P.O. Box 5005, Rochester, NH 03866-5005

All Rights Reserved

Printed in the United States of America

Order Number: 9031511-01 April 1996

SPECTRUM, **LANVIEW** and **BRIM** are registered trademarks and **Element Manager**, **EPIM**, **EPIM-100FX**, **EPIM-100TX**, **HubSTACK**, **MicroMMAC**, **SEH**, and **SEHI** are trademarks of Cabletron Systems, Inc.

All other product names mentioned in this manual may be trademarks or registered trademarks of their respective companies.

Printed on



Recycled Paper

FCC NOTICE

This device complies with Part 15 of the FCC rules. Operation is subject to the following two conditions: (1) this device may not cause harmful interference, and (2) this device must accept any interference received, including interference that may cause undesired operation.

NOTE: This equipment has been tested and found to comply with the limits for a Class A digital device, pursuant to Part 15 of the FCC rules. These limits are designed to provide reasonable protection against harmful interference when the equipment is operated in a commercial environment. This equipment uses, generates, and can radiate radio frequency energy and if not installed in accordance with the operator's manual, may cause harmful interference to radio communications. Operation of this equipment in a residential area is likely to cause interference in which case the user will be required to correct the interference at his own expense.

WARNING: Changes or modifications made to this device which are not expressly approved by the party responsible for compliance could void the user's authority to operate the equipment.

DOC NOTICE

This digital apparatus does not exceed the Class A limits for radio noise emissions from digital apparatus set out in the Radio Interference Regulations of the Canadian Department of Communications.

Le présent appareil numérique n'émet pas de bruits radioélectriques dépassant les limites applicables aux appareils numériques de la class A prescrites dans le Règlement sur le brouillage radioélectrique édicté par le ministère des Communications du Canada.

VCCI NOTICE

This equipment is in the 1st Class Category (information equipment to be used in commercial and/or industrial areas) and conforms to the standards set by the Voluntary Control Council for Interference by Information Technology Equipment (VCCI) aimed at preventing radio interference in commercial and/or industrial areas.

Consequently, when used in a residential area or in an adjacent area thereto, radio interference may be caused to radios and TV receivers, etc.

Read the instructions for correct handling.

この装置は、第一種情報装置（商工業地域において使用されるべき情報装置）で商工業地域での電波障害防止を目的とした情報処理装置等電波障害自主規制協議会（VCCI）基準に適合しております。

従って、住宅地域またはその隣接した地域で使用すると、ラジオ、テレビジョン受信機等に受信障害を与えることがあります。

取扱説明書に従って正しい取り扱いをして下さい。

CABLETRON SYSTEMS, INC. PROGRAM LICENSE AGREEMENT

IMPORTANT: Before utilizing this product, carefully read this License Agreement.

This document is an agreement between you, the end user, and Cabletron Systems, Inc. ("Cabletron") that sets forth your rights and obligations with respect to the Cabletron software program (the "Program") contained in this package. The Program may be contained in firmware, chips or other media. BY UTILIZING THE ENCLOSED PRODUCT, YOU ARE AGREEING TO BECOME BOUND BY THE TERMS OF THIS AGREEMENT, WHICH INCLUDES THE LICENSE AND THE LIMITATION OF WARRANTY AND DISCLAIMER OF LIABILITY. IF YOU DO NOT AGREE TO THE TERMS OF THIS AGREEMENT, PROMPTLY RETURN THE UNUSED PRODUCT TO THE PLACE OF PURCHASE FOR A FULL REFUND.

CABLETRON SOFTWARE PROGRAM LICENSE

1. **LICENSE.** You have the right to use only the one (1) copy of the Program provided in this package subject to the terms and conditions of this License Agreement.

You may not copy, reproduce or transmit any part of the Program except as permitted by the Copyright Act of the United States or as authorized in writing by Cabletron.
2. **OTHER RESTRICTIONS.** You may not reverse engineer, decompile, or disassemble the Program.
3. **APPLICABLE LAW.** This License Agreement shall be interpreted and governed under the laws and in the state and federal courts of New Hampshire. You accept the personal jurisdiction and venue of the New Hampshire courts.

EXCLUSION OF WARRANTY AND DISCLAIMER OF LIABILITY

1. **EXCLUSION OF WARRANTY.** Except as may be specifically provided by Cabletron in writing, Cabletron makes no warranty, expressed or implied, concerning the Program (including its documentation and media).

CABLETRON DISCLAIMS ALL WARRANTIES, OTHER THAN THOSE SUPPLIED TO YOU BY CABLETRON IN WRITING, EITHER EXPRESSED OR IMPLIED, INCLUDING BUT NOT LIMITED TO IMPLIED WARRANTIES OF MERCHANTABILITY AND FITNESS FOR A PARTICULAR PURPOSE, WITH RESPECT TO THE PROGRAM, THE ACCOMPANYING WRITTEN MATERIALS, AND ANY ACCOMPANYING HARDWARE.

2. **NO LIABILITY FOR CONSEQUENTIAL DAMAGES.** IN NO EVENT SHALL CABLETRON OR ITS SUPPLIERS BE LIABLE FOR ANY DAMAGES WHATSOEVER (INCLUDING, WITHOUT LIMITATION, DAMAGES FOR LOSS OF BUSINESS, PROFITS, BUSINESS INTERRUPTION, LOSS OF BUSINESS INFORMATION, SPECIAL, INCIDENTAL, CONSEQUENTIAL, OR RELIANCE DAMAGES, OR OTHER LOSS) ARISING OUT OF THE USE OR INABILITY TO USE THIS CABLETRON PRODUCT, EVEN IF CABLETRON HAS BEEN ADVISED OF THE POSSIBILITY OF SUCH DAMAGES. BECAUSE SOME STATES DO NOT ALLOW THE EXCLUSION OR LIMITATION OF LIABILITY FOR CONSEQUENTIAL OR INCIDENTAL DAMAGES, OR ON THE DURATION OR LIMITATION OF IMPLIED WARRANTIES, IN SOME INSTANCES THE ABOVE LIMITATIONS AND EXCLUSIONS MAY NOT APPLY TO YOU.

UNITED STATES GOVERNMENT RESTRICTED RIGHTS

The enclosed product (a) was developed solely at private expense; (b) contains “restricted computer software” submitted with restricted rights in accordance with Section 52227-19 (a) through (d) of the Commercial Computer Software - Restricted Rights Clause and its successors, and (c) in all respects is proprietary data belonging to Cabletron and/or its suppliers.

For Department of Defense units, the product is licensed with “Restricted Rights” as defined in the DoD Supplement to the Federal Acquisition Regulations, Section 52.227-7013 (c) (1) (ii) and its successors, and use, duplication, disclosure by the Government is subject to restrictions as set forth in subparagraph (c) (1) (ii) of the Rights in Technical Data and Computer Software clause at 252.227-7013. Cabletron Systems, Inc., 35 Industrial Way, Rochester, New Hampshire 03867-0505.

CONTENTS

CHAPTER 1 INTRODUCTION

1.1	Using This Manual.....	1-1
1.2	Document Conventions	1-2
1.3	Getting Help.....	1-3
1.4	Related Manuals.....	1-3

CHAPTER 2 SEHI FEATURES AND OPTIONS

2.1	SEHI Overview	2-1
2.2	SEHI Features	2-2
2.3	Stackable Capabilities	2-3
2.4	Rack Mounting Capabilities	2-4
2.5	Remote Network Management.....	2-4
2.6	Optional 100BASE-TX and 100BASE-FX EPIMs.....	2-4

CHAPTER 3 INSTALLATION REQUIREMENTS AND SPECIFICATIONS

3.1	Cable Specifications	3-1
3.1.1	HubSTACK Interconnect Cable Requirements.....	3-1
3.1.2	UTP Cable Specifications	3-2
3.1.3	Multimode Specifications for the EPIM-100FX	3-3
3.2	Network Cable Lengths	3-4
3.3	Network Port Specifications.....	3-5
3.4	COM Port Requirements	3-5
3.5	Operating Specifications.....	3-6
3.5.1	Power Supply Requirements	3-6
3.5.2	Environmental Requirements	3-6
3.6	Agency Approvals.....	3-7
3.7	Physical Specifications	3-7

CHAPTER 4 INSTALLATION

4.1	Unpacking the SEHI	4-1
4.2	Pre-Installation Checkout	4-2
4.3	Tabletop or Shelf Installation	4-3
4.4	Rackmount Installation	4-4
4.5	Powering Up and Stacking the SEHI.....	4-7
4.6	Installing the EPIM-100TX or the EPIM-100FX	4-9

CHAPTER 5 CONNECTING TO THE NETWORK

5.1 Connecting the SEHI to the Network5-1
5.1.1 Connecting to Network Ports.....5-1
5.1.2 Connecting a UTP Segment to an EPIM-100TX.....5-2
5.1.3 Connecting a Fiber Segment to the EPIM-100FX.....5-4
5.2 Testing the Installation5-5

CHAPTER 6 TROUBLESHOOTING

6.1 Installation Test.....6-1
6.2 Using LANVIEW.....6-2
6.3 Using the RESET Button6-4
6.4 Setting the NVRAM Switch6-5

CHAPTER 7 LOCAL MANAGEMENT

7.1 Local Management Keyboard Conventions7-2
7.2 Management Terminal Setup.....7-3
7.3 Accessing Local Management7-6
7.4 The Feature Selection Screen7-7
7.5 The Community Name Table Screen.....7-8
7.5.1 Editing the Community Name Field.....7-9
7.6 The Configuration Screen7-10
7.6.1 Setting the IP Address.....7-12
7.6.2 Setting the Subnet Mask7-12
7.6.3 Setting the Default Gateway.....7-13
7.6.4 Using the Port Enable Override.....7-13
7.6.5 Exiting the Configuration Screen.....7-14
7.7 The Trap Table Screen7-14
7.7.1 Configuring the Trap Table.....7-15
7.7.2 Exiting the Trap Table Screen.....7-15
7.8 The SNMP Tools Screen7-16
7.8.1 Getting Individual OIDs7-18
7.8.2 Getting the Next OID7-18
7.8.3 Setting an OID.....7-18
7.8.4 Viewing Multiple OIDs7-19
7.8.5 Walking Through OIDs.....7-19
7.8.6 Stepping Through OIDs.....7-20
7.8.7 Cycling Through OIDs.....7-20
7.8.8 Exiting the SNMP Tools Screen7-20

7.9 The Device Statistics Screen..... 7-21

7.9.1 Selecting the Appropriate Module/Port 7-23

7.9.2 Using the ENABLE PORT Command 7-24

7.9.3 Using the DISABLE PORT Command 7-24

7.9.4 Exiting the Device Statistics Screen 7-24

APPENDIX A EPIM SPECIFICATIONS

A.1 EPIM Specifications..... A-1

A.1.1 EPIM-100TX..... A-1

A.1.2 EPIM-100FX..... A-2

APPENDIX B IMAGE FILE DOWNLOAD USING OIDS

B.1 Setting Up a UNIX Workstation as a TFTP Server..... B-2

B.2 Standard Local Download B-3

INDEX

CHAPTER 1

INTRODUCTION

Welcome to the Cabletron Systems **SEHI100TX-22 100BASE-T Intelligent Stackable Hub User's Guide**. This manual provides installation instructions, troubleshooting, and reference information for the SEHI100TX-22.

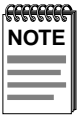

The term SEHI (Stackable Ethernet Hub with Intelligence) is used throughout this manual when describing the features and functions of the SEHI100TX-22.

1.1 USING THIS MANUAL

Read through this manual to gain an understanding of the features and capabilities of the SEHI. A general knowledge of Ethernet and IEEE 802.3u type data communications networks and their physical layer components is helpful when installing the SEHI.

Chapter 1, **Introduction**, outlines the contents and describes the objectives and conventions of this manual. This chapter also provides getting help information and concludes with a list of related manuals.

Chapter 2, **SEHI Features and Options**, briefly describes SEHI features and provides information about available options.

Chapter 3, **Installation Requirements and Specifications**, provides installation requirements, network guidelines, and SEHI specifications.

Chapter 4, **Installation**, contains instructions for installing the SEHI as a stackable or standalone hub.

Chapter 5, **Connecting to the Network**, explains how to connect the SEHI to the network using the various media types.

Chapter 6, **Troubleshooting**, describes how to use the LANVIEW LEDs to troubleshoot network problems.

Chapter 7, **Local Management**, describes how to use SEHI Local Management screens and the available commands.

Appendix A, **EPIM Specifications**, provides specifications, cabling information, and switch settings for the Ethernet Port Interface Modules.

Appendix B, **Image File Download Using OIDs**, provides instructions for setting up a TFTP server and downloading an image file to the SEHI by setting specific MIB OID strings.

1.2 DOCUMENT CONVENTIONS

The following conventions are used throughout this document:

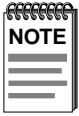

Note symbol. Calls the reader's attention to any item of information that may be of special importance.



Tip symbol. Conveys helpful hints concerning procedures or actions.



Caution symbol. Contains information essential to avoid damage to the equipment.



Warning symbol. Warns against an action that could result in equipment damage, personal injury or death.

1.3 GETTING HELP

If you need additional support related to this device, or if you have any questions, comments, or suggestions concerning this manual, contact Cabletron Systems Technical Support:

By phone	(603) 332-9400 Monday – Friday; 8 A.M. – 8 P.M. Eastern Time
By CompuServe	GO CTRON from any ! prompt
By Internet mail	support@ctron.com
By FTP	ctron.com (134.141.197.25)
Login	<i>anonymous</i>
Password	<i>your email address</i>

Before calling Cabletron Systems Technical Support, have the following information ready:

- A description of the failure
- A description of any action(s) already taken to resolve the problem (e.g., changing mode switches, rebooting the unit, etc.)
- A description of your network environment (layout, cable type, etc.)
- Network load and frame size at the time of trouble (if known)
- The serial and revision numbers of all Cabletron Systems products in the network
- The device history (i.e., have you returned the device before, is this a recurring problem, etc.)
- Any previous Return Material Authorization (RMA) numbers

1.4 RELATED MANUALS

Use the Cabletron Systems *SEH100TX-22 100BASE-T User's Guide* to supplement the procedures and other technical data provided in this manual. The procedures contained in the *SEH100TX-22 100BASE-T User's Guide* are referenced where appropriate, but not repeated in this manual.

CHAPTER 2

SEHI FEATURES AND OPTIONS

This chapter provides an overview of the SEHI and contains sections detailing features and available options.



The terms SEHI (Stackable Ethernet Hub with Intelligence) and SEH (Stackable Ethernet Hub) are used throughout this manual when describing the features and functions of the SEHI100TX-22 and the SEH100TX-22.

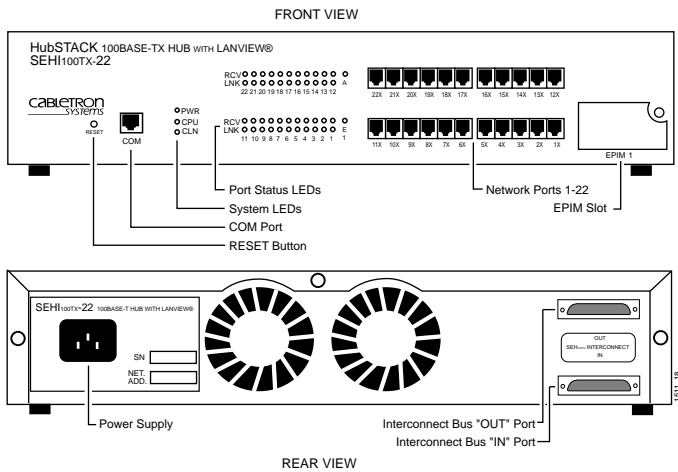

Figure 2-1 The SEHI100TX-22

2.1 SEHI OVERVIEW

The SEHI100TX-22 is an intelligent repeating hub providing 22 RJ45 ports and one Ethernet Port Interface Module (EPIM) port on the front panel for network connections. The SEHI has two rear panel HubSTACK Interconnect Bus ports for stackable connections. The SEHI100TX-22 is designed to manage the Cabletron Systems non-intelligent stackable hub, the SEH100TX-22.



The SEHI100TX-22 operates in a 100BASE-T Ethernet network. This product will NOT operate in a 10BASE-T environment. Connect the SEHI100TX-22 and SEH100TX-22 only to similar 100BASE-T products.

The SEHI100TX-22 supports the EPIM-100TX and the EPIM-100FX. No other Cabletron Systems EPIMs operate in this device.

2.2 SEHI FEATURES

Repeater Functionality

The SEHI fully conforms to the IEEE 802.3u Repeater specifications. The SEHI transmits retimed data packets, regenerates the preamble, extends fragments, and arbitrates collisions.

The SEHI100TX-22 meets IEEE 802.3u Repeater Class I standards. Class I standards allow one repeater between any two Data Terminal Equipment (DTE) devices within a single collision domain (network).

The SEHI automatically partitions problem segments, and reconnects repaired segments to the network. This feature minimizes the impact on network operation resulting from a problem on one segment by isolating the problem segment. Only devices on the problem segment are affected. When the problem is solved, the SEHI automatically reconnects the isolated segment to the network.

Polarity Detection and Correction

Each twisted pair port on the SEHI incorporates a polarity detection and correction feature that allows the SEHI to pass data regardless of the polarity of the twisted pair segment's receive link.

FLASH EEPROMs

The SEHI uses FLASH EEPROMs that allow the downloading of new and updated firmware using Cabletron Systems SPECTRUM Element Manager/Windows or any device using BOOTP or TFTP protocols.

LANVIEW LEDs

Cabletron Systems LANVIEW status monitoring and diagnostics system is a troubleshooting tool that helps in diagnosing power failures, collisions, cable faults, and link problems. The LANVIEW LEDs are conveniently located on the SEHI front panel.

RESET Button

Resetting the hub with the front panel RESET Button reboots the SEHI and initializes the processor. Resetting the SEHI also resets all of the SEH non-intelligent hubs in the stack.

Local Management

Manage the SEHI and its attached segments through Local Management on the SEHI. Local Management provides full packet and error statistics for the entire stack, individual device, or individual port. Access Local Management by attaching a DEC VT320 terminal or a PC using VT320 emulation software to the RJ45 COM port on the SEHI. Cabletron Systems provides a UTP console cable with RJ45 connectors at each end, adaptors for DB9 or DB25 connections and an instruction sheet with adaptor pinout information with the SEHI. Chapter 7, **Local Management**, provides detailed information on setting up and managing your network through Local Management.

2.3 STACKABLE CAPABILITIES

The SEHI100TX-22 intelligent hub is designed to manage a stack of up to four Cabletron Systems SEH100TX-22 non-intelligent hubs. The SEHI is placed at the bottom of the stack. It manages all SEH hubs in the stack and provides full packet and error statistics for the entire stack, individual device, or individual port.

Stack up to four SEH non-intelligent hubs with one SEHI using the Cabletron Systems external HubSTACK Interconnect cables provided with each SEH. Stackable configurations make it possible to maintain only one IEEE repeater hop while providing up to 120 ports. Hubs can be added or removed from the stack without having to power down the entire stack.

2.4 RACK MOUNTING CAPABILITIES

The SEHI can be installed in a 19-inch rack. Cabletron Systems provides brackets and mounting screws with the SEHI. See Chapter 4, **Installation**, for complete rack mounting instructions.

2.5 REMOTE NETWORK MANAGEMENT

Manage the SEHI remotely with any SNMP network management system. Cabletron Systems offers the following remote management packages:

- Cabletron Systems SPECTRUM
- Cabletron Systems SPECTRUM Element Manager/Windows
- Cabletron Systems Remote SPECTRUM Portable Management Applications
- Third Party SNMP compliant Network Management Packages

2.6 OPTIONAL 100BASE-TX and 100BASE-FX EPIMs

100BASE-TX and 100BASE-FX EPIMs are not included with the SEHI but can be purchased separately from Cabletron Systems.

EPIMs enable the expansion of a network through different types of media. Cabletron Systems offers two optional EPIMs for the SEHI100TX-22 and the SEH100TX-22 as shown in Table 2-1.

Table 2-1 100BASE-TX/FX EPIMs

EPIM	Media Type	Connector
EPIM-100TX	Category 5 UTP Cable	RJ45
EPIM-100FX	Multimode Fiber Optic Cable	SC

CHAPTER 3

INSTALLATION REQUIREMENTS AND SPECIFICATIONS

This Chapter describes cabling requirements, network guidelines, and operating specifications for the SEHI100TX-22.



The network must meet the requirements and conditions specified in this chapter to obtain satisfactory performance from this equipment. Failure to follow these guidelines could result in poor network performance.

3.1 CABLE SPECIFICATIONS

The front panel SEHI100TX-22 network ports support Category 5 Unshielded Twisted Pair (UTP) cabling. Ethernet Port Interface Modules (EPIMs) expand the network using UTP (EPIM-100TX) or multimode fiber optic (EPIM-100FX) cabling. For information concerning the two EPIM types, refer to Appendix A. The rear panel Interconnect Bus ports support Cabletron Systems Interconnect cables for stackable applications.

Take care in planning and preparing the network cabling and connections. The quality of the connections and the length of cables are critical factors in determining the reliability of the network. The following sections describe specifications for each media type.

3.1.1 HubSTACK Interconnect Cable Requirements

Attach the SEHI to the stacked SEH modules with the HubSTACK Interconnect cables provided with each SEH and available only from Cabletron Systems (P/N 9380209). The cable attaches to the SEHI rear panel bus “OUT” port. The SEHI must be placed at the bottom of the stack. Stack up to four SEH hubs together with one SEHI.

3.1.2 UTP Cable Specifications

The device at the other end of the twisted pair segment must meet IEEE 802.3u 100BASE-T specifications. When connecting a 100BASE-TX Twisted Pair Segment to the SEHI twisted pair network ports and the EPIM-100TX module, the network must meet the following requirements:

Length

The IEEE 802.3u 100BASE-T standard requires that 100BASE-TX devices be capable of transmitting over a 100 meter (328 foot) link using Category 5 UTP wire.

Impedance

UTP cables typically have an impedance of between 85 to 110 ohms.

Jitter

Intersymbol interference and reflections cause jitter in the bit cell timing, resulting in data errors. A 100BASE-TX link must not generate more than 1.4 ns of jitter. If the cable meets the impedance requirements for a 100BASE-TX link, jitter should not be a concern.

Crosstalk

Crosstalk is caused by signal coupling between the different cable pairs contained within a multi-pair cable bundle. 100BASE-TX transceivers are designed so that the user does not need to be concerned about cable crosstalk, provided the cable meets all other requirements.

Noise

Noise is caused by either crosstalk or externally induced impulses. Impulse noise may cause data errors if the impulses occur at very specific times during data transmission. Generally, the user need not be concerned about noise. If noise-related data errors are suspected, it may be necessary to either reroute the cable or eliminate the source of the impulse noise.

Propagation Delay

Propagation delay is the amount of time it takes data to travel from the sending device to the receiving device. Total propagation delay allowed for the network is 256 bit times (2.56 μ s) in one direction (5.12 μ s round trip). If the total propagation delay between any two nodes on the network exceeds 2.56 μ s, then use bridges or other devices to further segment the network.

Temperature

The attenuation of PVC insulated cable varies significantly with temperature. At temperatures greater than 40°C (104°F), Cabletron Systems recommends the use of plenum-rated cables to ensure that cable attenuation remains within specification.

3.1.3 Multimode Specifications for the EPIM-100FX

The SEHI supports the Cabletron Systems EPIM-100FX. The EPIM-100FX meets IEEE 802.3u standards. When connecting a fiber optic segment to the SEHI EPIM-100FX module, the network must meet the following requirements:

Cable Loss

Test the fiber optic cable with a fiber optic attenuation test set adjusted for an 850 nm wavelength. This test verifies that the signal loss in a cable is within an acceptable level. The maximum loss for a multimode fiber optic cable is 11.0 dB.

Fiber Optic Budget and Propagation Delay

Determine the maximum fiber optic cable length by calculating the fiber optic budget delay and total network propagation before fiber optic cable runs are incorporated in any network design.

Fiber optic budget is the combination of the optical loss due to the fiber optic cable, in-line splices, and fiber optic connectors.

Propagation delay (collision delay) is the amount of time it takes data to travel from the sending device to the receiving device. Total propagation delay allowed for the entire network is 256 bit times (2.56 μ s) in one direction (5.12 μ s round trip). If the total propagation delay between any two nodes on the network exceeds 2.56 μ s, then use bridges or other devices to further segment the network.

3.2 NETWORK CABLE LENGTHS

This section details the maximum network cable lengths specified by the IEEE 802.3u standard for a Class I repeater. As stated previously, the physical size of the network is limited primarily by propagation delay. The round trip delay cannot exceed 512 bit times or 5.12 μ s.



A stack of five SEH hubs or four SEH hubs and one SEHI hub is equivalent to one repeater.

A 100BASE-T network might use all UTP links, all fiber links or a combination of both. Table 3-1 details the maximum link lengths for each type and combination of cable when used with a Class I repeater.

Figure 3-1 shows a simplified example of a network with one Class I repeater. Link segments A and B represent the longest links in the network. In this case, if both segment A and segment B are UTP, each segment may be up to 100 meters long for a maximum network length of 200 meters. If segment A is UTP and segment B is fiber, the maximum length of the network is 263 meters (with a maximum UTP segment length of 100 meters). If both segments A and B are fiber, the maximum length is 274 meters.



The maximum length of an individual UTP segment may be no more than 100 meters.

Table 3-1 Maximum Class I Network Cable Length

Number of Repeaters	UTP	UTP & Fiber	Fiber
1	200 m	263 m	274 m

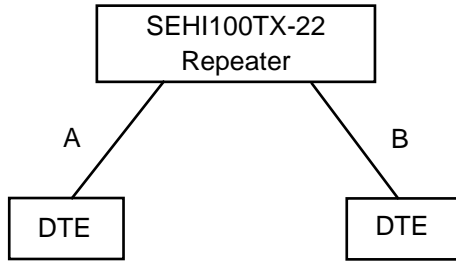
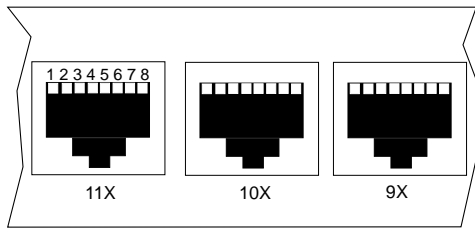

Figure 3-1 Class I Network

3.3 NETWORK PORT SPECIFICATIONS

The SEHI network ports use shielded RJ45 connectors that support UTP cabling. Figure 3-2 shows the RJ45 pinouts.



- | | |
|---------------|---------------|
| 1. Receive + | 5. Not Used |
| 2. Receive - | 6. Transmit - |
| 3. Transmit + | 7. Not Used |
| 4. Not Used | 8. Not Used |

09162_02

Figure 3-2 RJ45 Network Ports

3.4 COM PORT REQUIREMENTS

The RJ45 COM port supports access to a Local Management Console. The COM port supports a Digital Equipment Corporation VT320 terminal or PC emulation of the VT320 terminal. Figure 3-3 shows the pinouts for the RJ45 COM port.

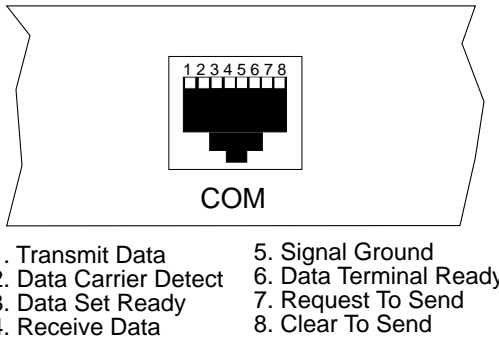

1511_15

Figure 3-3 COM Port Pinouts

3.5 OPERATING SPECIFICATIONS

The operating specifications for the SEHI100TX-22 are described in this section. Cabletron Systems reserves the right to change these specifications at any time without notice.

3.5.1 Power Supply Requirements

The SEHI uses a universal power supply. The input requirements are listed in Table 3-2.

Table 3-2 Power Supply Requirements

Line Input Range Volts (V)	Current Amperes (A)	Frequency Hertz (Hz)
100–125 Vac	4.0 A	50/60 Hz
200–250 Vac	2.0 A	

3.5.2 Environmental Requirements

This section details the environmental requirements of the SEHI.

Operating Temperature: 5°C to 40°C (41°F to 104°F)

Storage Temperature: -30°C to 90°C (-22°F to 194°F)

Operating Humidity: 5% to 95% (non-condensing)

CHAPTER 4

INSTALLATION

This chapter outlines the procedure for attaching the SEHI to the network as a stackable or standalone device. Ensure that the network meets the guidelines and requirements outlined in Chapter 3, **Installation Requirements and Specifications**, before installing the SEHI.

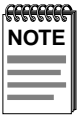

A single phase grounded power receptacle that meets the requirements listed in Chapter 3 must be located within seven feet of the installation.



Failure to follow installation instructions may result in an electrical shock hazard.

4.1 UNPACKING THE SEHI

Unpack the SEHI as follows:

1. Remove the shipping material covering the SEHI in the shipping box.
2. Carefully remove the SEHI from the shipping box and set it aside to prevent damage.
3. Visually inspect the SEHI. If there are any signs of damage, contact Cabletron Systems Technical Support immediately.
4. Read the SEHI Release Notes included in the shipping box.

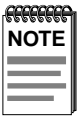

Cabletron Systems includes a 3-1/2" disk with the SEHI100TX-22 that contains a backup copy of the FLASH Firmware Image File. Download the file to the SEHI100TX-22 if the existing image becomes corrupted. See Appendix B for detailed download instructions.

4.2 PRE-INSTALLATION CHECKOUT

The SEHI is equipped with an NVRAM reset switch (Figure 4-1) located behind the grillwork on the side of the hub. Ensure that this switch is in the **DOWN** position by looking in through the grillwork on the right side of the hub. If the switch is **UP**, move it into the **DOWN** position with a **non-metallic** tool. Do not remove the chassis cover to perform this operation. Leaving the switch in the **UP** position results in user-installed parameters such as IP address and Community Names being cleared from NVRAM whenever the SEHI loses power and/or is reset. See Chapter 6, Section 6.4 for detailed instructions on setting the NVRAM switch.

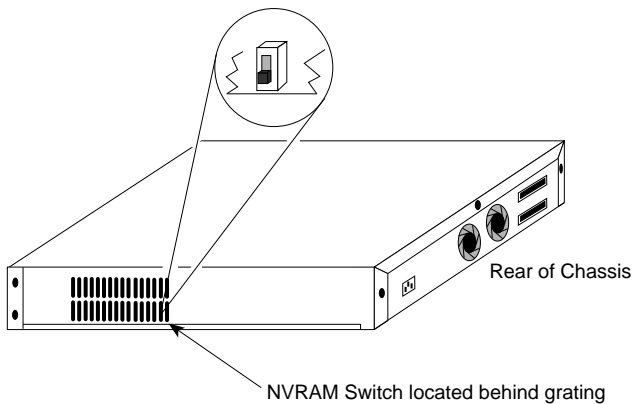

1511_02

Figure 4-1 NVRAM Switch Location

The SEHI may be installed on a tabletop or shelf, or in a 19-inch rack, and configured as a standalone or stacked hub.

Refer to Section 4.3 for information concerning a tabletop or shelf installation. Section 4.4 describes the rackmount installation.

4.3 TABLETOP OR SHELF INSTALLATION

This section provides guidelines for installation on a tabletop or shelf.

Tabletop and shelf installations must be within reach of the network cabling and meet the requirements listed below:

- In a shelf installation, the shelf must be able to support 30 pounds of static weight for each device in the stack.
- Maintain a temperature of between 5°C (41°F) and 40°C (104°F) at the installation site with fluctuations of less than 10°C per hour.

The SEHI must be located within seven feet of its power source and with an unrestricted free surface area as shown in Figure 4-2.



In order to allow for proper cooling, there must be a two-inch clearance on either side and the back of the unit.

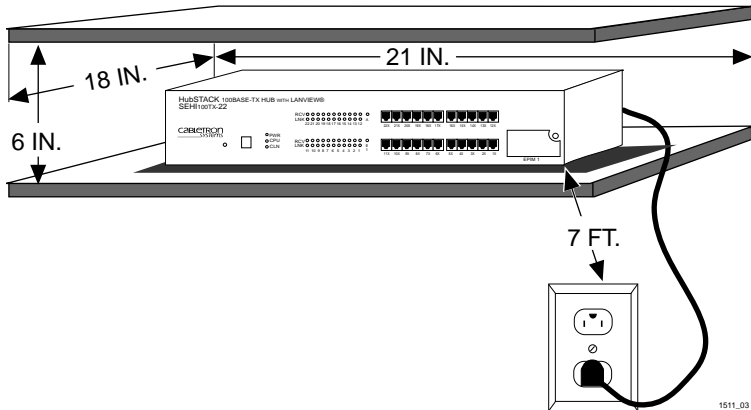

Figure 4-2 Tabletop or Shelf Installation

Proceed to Section 4.5, **Powering Up and Stacking the SEHI.**

4.4 RACKMOUNT INSTALLATION

To install the SEHI in a 19-inch rack, Cabletron Systems provides a kit with the SEHI that includes rackmount brackets, mounting screws, and a strain-relief bracket for cable management.

Rack mounting the SEHI involves the following:

- Attaching the strain-relief bracket
- Rack mounting the SEHI
- Stacking the SEHI when applicable

Attaching the Strain-Relief Bracket

Attach the strain-relief bracket to the front of the SEHI as follows:

1. Locate the strain-relief bracket and four 8-32 x 3/8-inch pan-head screws from the rackmount kit.



Do NOT attempt to attach the strain-relief bracket with screws other than the 8-32 x 3/8-inch screws included with the SEHI. Use of longer screws may damage the unit or cause electrical shock.

2. Attach the strain-relief bracket to the bottom of the SEHI (Figure 4-3).

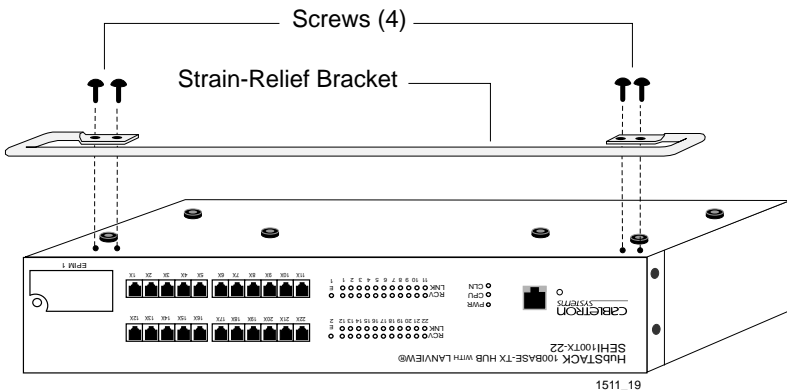

Figure 4-3 Attaching the Strain Relief Bracket

Rack Mounting the SEHI

Refer to Figure 4-4 and proceed as follows to install the SEHI into a 19-inch rack.

1. Remove the four cover screws (two from each side) located along the front edges of each side of the SEHI.



Do not remove the cover from the SEHI100TX-22. Do not remove any other screws from the unit.

2. Using the four 6-32 x 3/8-inch replacement flathead cover screws provided in the rack mounting kit, attach the rack mounting brackets to each side of the SEHI.

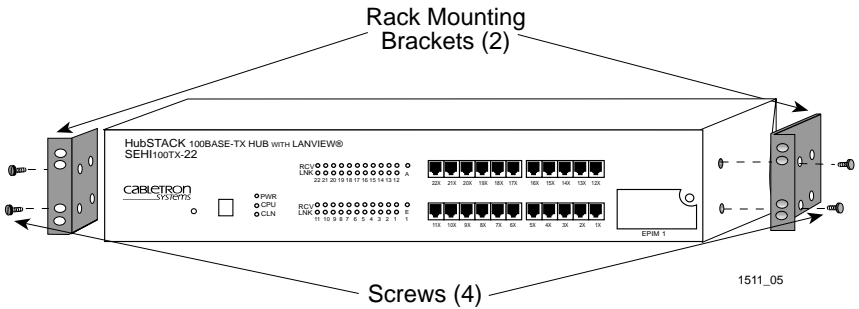

Figure 4-4 Installing the Rack Mounting Brackets

3. Ensure that the rack used will support the unit, and that the rack will remain stable with the unit installed in it. Support the SEHI securely from underneath, and align the mounting brackets of the SEHI chassis with the screw holes in the equipment rack as shown in Figure 4-5. Fasten the SEHI to the equipment rack securely.

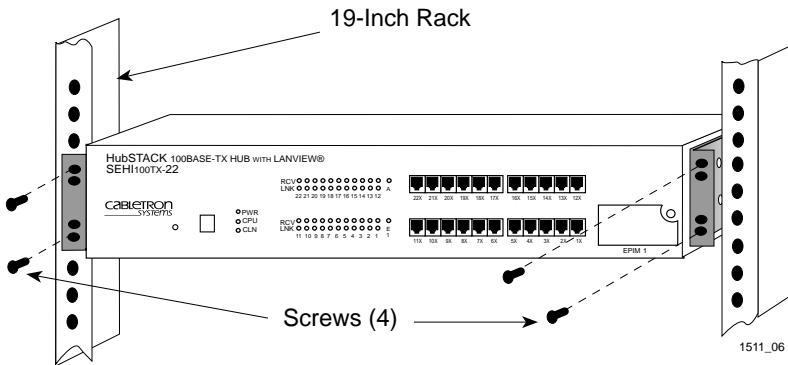

Figure 4-5 Installing the SEHI in the Rack



The cooling fans at the rear panel of the SEH must have adequate clearance (**two inches on either side and in the rear**) for unrestricted air flow. The temperature for the selected location must be maintained between 5°C and 40°C, and fluctuate less than 10°C per hour.

Proceed to Section 4.5, **Powering Up and Stacking the SEHI.**

4.5 POWERING UP AND STACKING THE SEHI

The following section details the procedures that **must** be followed to power up and interconnect stacked hubs. Failure to follow this procedure may result in damage to the equipment.



If you are using an intelligent hub (SEHI) to manage the stack, you must locate the SEHI at the bottom of the stack.

The SEHI must be completely powered up and initialized before powering up and interconnecting the rest of the stack.



The SEH and the SEHI have universal power supplies that allow connection to power sources from 100 Vac to 125 Vac @ 4.0 A or 200 Vac to 250 Vac @ 2.0 A, 50/60 Hz.

1. Power up the SEHI by plugging the power cord into the back panel of the SEHI and plugging the other end into a grounded receptacle.

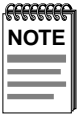

Locate the SEHI at the bottom of the stack.

For management purposes, stacked hubs are always numbered from 1 to 5 starting at the bottom.

2. Verify that the PWR LED is on, indicating that the SEHI is receiving power. After the SEHI runs a self test and completes the boot process successfully, the CPU LED blinks green indicating normal operation. If the LED remains red, the processor is faulty; contact Cabletron Systems Technical Support. Do not proceed with the following steps until the CPU LED is a steady blinking green.



Do NOT power up or interconnect any other hubs in the stack until the SEHI has successfully completed the boot process.

3. Power up the SEH above the SEHI in the stack by plugging the power cord into the back panel of the SEH and plugging the other end into a grounded receptacle.

- Verify that the **PWR** LED is on, indicating that the SEH is receiving power.



Do NOT connect the interconnect cable between the SEH and the SEHI before powering up the SEH. Otherwise damage to the SEH may result.

- Attach the HubSTACK Interconnect cable provided with the SEH to the “IN” port on the rear panel of the SEH as shown in Figure 4-6.
- Attach the other end of the interconnect cable to the “OUT” port on the rear panel of the hub at the bottom of the stack.



Do not leave an interconnect cable connected at only one end during network operation. Corrupted data may result.

- Repeat steps 3 through 6 until all SEH hubs are connected.

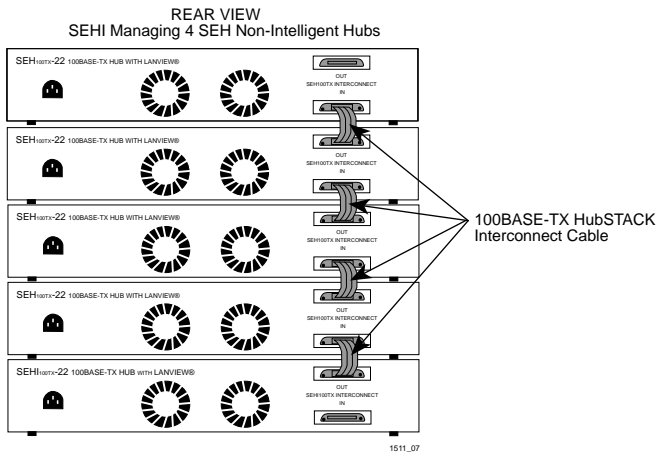

Figure 4-6 Stacking the SEHI

4.6 INSTALLING THE EPIM-100TX OR THE EPIM-100FX

This section contains procedures on how to install the EPIM-100TX or the EPIM-100FX to upgrade or change the capabilities of your SEHI. After installing a new EPIM, refer to the appropriate EPIM section in Appendix A to verify proper operation.



Observe all static precautions while handling an EPIM.

Install an EPIM-100TX or an EPIM-100FX as follows:



When removing an EPIM, pull the module straight out to prevent damage to the connector.

1. Remove the coverplate or the existing EPIM (whichever applies).
2. Slide the new EPIM into place, making sure that the connectors on the rear of the EPIM align correctly and firmly with the connector inside the SEHI. Refer to Figure 4-7.
3. Install the mounting screw.

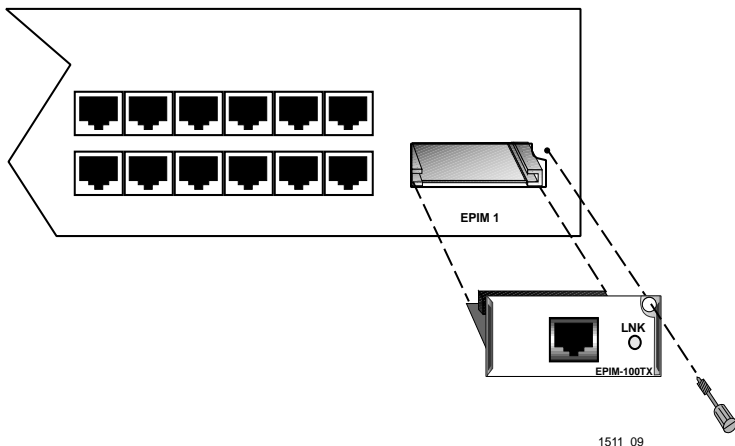

Figure 4-7 Installing an EPIM-100TX/FX

CHAPTER 5

CONNECTING TO THE NETWORK

This chapter outlines the procedure for connecting the SEHI to a network. Ensure that the network meets the guidelines and requirements outlined in Chapter 3, **Installation Requirements and Specifications**, before installing the SEHI.

5.1 CONNECTING THE SEHI TO THE NETWORK

The procedure for connecting network segments to the SEHI varies depending on the media and ports being connected. Refer to the following list and perform the procedure described in the subsections that apply to connecting the SEHI to a network:

- Network Ports Section 5.1.1
- EPIM-100TX Section 5.1.2
- EPIM-100FX Section 5.1.3

Prior to connecting the network cabling, check the connectors for the proper pinouts as shown in Chapter 3.

5.1.1 Connecting to Network Ports

Attach UTP segments to the RJ45 Network Ports on the front panel of the SEHI. Each twisted pair port on the SEHI incorporates a polarity detection and correction feature. The polarity detection and correction feature allows the SEHI to pass data regardless of the polarity of the twisted pair segment's receive link. Operating in this condition is not recommended; the segment should be removed from the network and wired correctly by a technician.

Connect the twisted pair segments to the SEHI as follows:

1. Insert the RJ45 connector from each twisted pair segment into the desired network port on the SEHI. See Figure 5-1.

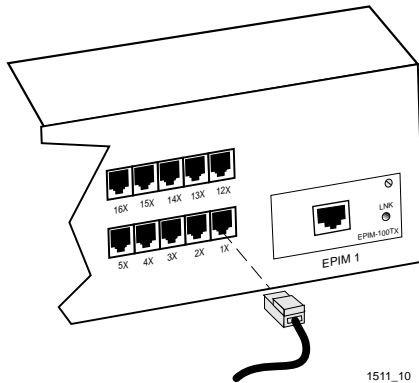

Figure 5-1 SEHI Network Ports

2. Check that the applicable **LNK** LED for the port is on. If the LED is off, perform each of the following steps until it is on:
 - a. Check that the 100BASE-TX device at the other end of the twisted pair segment is powered up.
 - b. Verify that the RJ45 connector on the twisted pair segment has the proper pinouts. Check the cable for continuity.
 - c. Check that the twisted pair connection meets dB loss and cable specifications outlined Chapter 2.

If a link is not established, contact Cabletron Systems Technical Support.

5.1.2 Connecting a UTP Segment to an EPIM-100TX

The EPIM-100TX is often used to provide a connection between the SEHI and a bridge, router, or switch. Normally, in this configuration, a “straight-through” cable is used and the EPIM crossover switch shown in Figure 5-2 is set to “not crossed over.”

The EPIM-100TX is also used to provide another RJ45 port to connect to a UTP segment. Before connecting a segment to the EPIM-100TX, check each end of the segment to determine if the wires have been crossed over for the proper connection. If the wires do not cross over, use the switch on the EPIM-100TX to internally cross over the RJ45 port. Refer to Figure 5-2 to properly set the EPIM-100TX crossover switch.

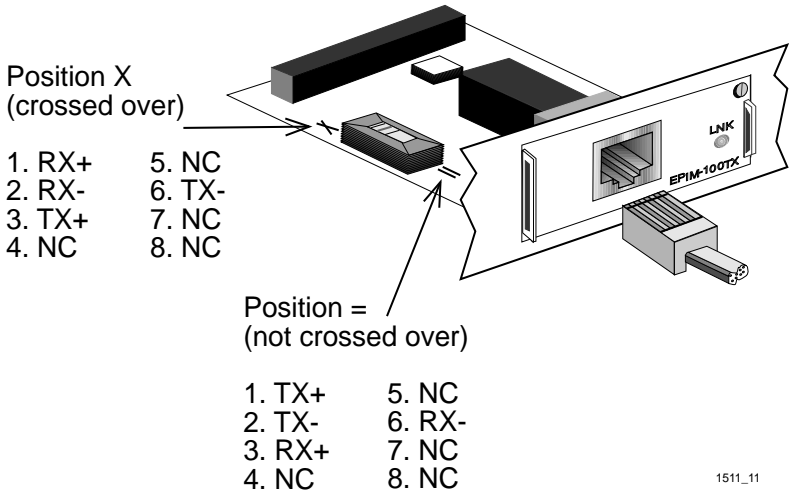

Figure 5-2 EPIM-100TX Crossover Switch

Connect an EPIM-100TX to a twisted pair segment as follows:

1. Connect the twisted pair segment to the module by inserting the RJ45 connector on the twisted pair segment into the RJ45 port on the module. See Figure 5-2.
2. Check that the **LNK** LED on the EPIM-100TX is on. If the LED is off, perform each of the following steps until it is on:
 - a. Check that the 100BASE-TX device at the other end of the twisted pair segment is powered up.
 - b. Verify that the RJ45 connector on the twisted pair segment has the proper pinouts.
 - c. Check the cable for continuity.
 - d. Check that the twisted pair connection meets dB loss and cable specifications outlined in Chapter 3, Section 3.1.2.
 - e. Check that the crossover switch is in the correct position.

If a link is not established, contact Cabletron Systems Technical Support.

5.1.3 Connecting a Fiber Segment to the EPIM-100FX

The EPIM-100FX has an SC style network port (see Figure 5-3). Cabletron Systems supplies fiber optic cables using SC connectors that are keyed to insure proper crossover of the transmit and receive fibers.



An odd number of crossovers (preferably one) must be maintained between devices so that the transmit port of one device is connected to the receive port of the other device and vice versa.

Use the following steps to connect a fiber segment to the SEHI:

1. Remove the protective plastic covers from the fiber optic ports on the module port and from the ends of the connectors.



Do not touch the ends of the fiber optic strands, and do not let the ends come in contact with dust, dirt, or other contaminants. Contamination of the ends causes problems in data transmissions. If the ends become contaminated, clean them with alcohol using a soft, clean, lint free cloth.

2. Insert one end of the SC connector into the EPIM-100FX on the SEHI. See Figure 5-3.

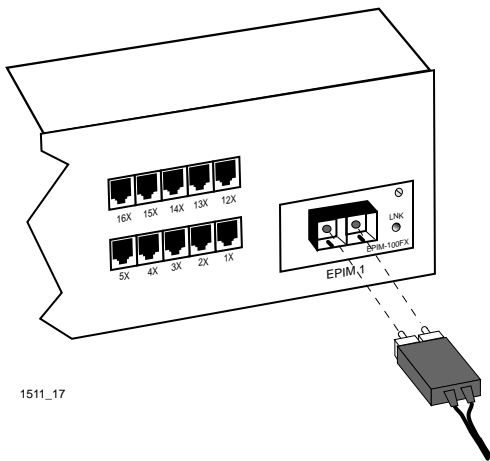

Figure 5-3 EPIM-100FX Port

3. At the other end of the fiber optic cable, attach the SC connector to the other device.
4. Check that the EPIM-100FX **LNK** LED is on. If the LED is off, perform the following steps until it is on:
 - a. Check that the power is turned on for the device at the other end of the link.
 - b. Verify proper “cross-over” of fiber strands between the applicable port on the SEHI and the fiber optic device at the other end of the fiber optic link segment.
 - c. Verify that the fiber connection meets the dB loss specifications outlined in Chapter 3.

If a link is not established, contact Cabletron Systems Technical Support.

5.2 TESTING THE INSTALLATION

The SEHI00TX-22 is now ready for operation. Before placing the network into service, test that all stations can be addressed and that the SEHI and all stations are indicating normal operation. Ensure that the networking software is configured properly to match the installed network. If there are any errors or abnormal operation, proceed to Chapter 6, **Troubleshooting**.

CHAPTER 6

TROUBLESHOOTING

This chapter contains instructions for using LANVIEW LEDs to troubleshoot physical layer network problems. It also describes how to reset the SEHI and how to reset the NVRAM switch.

6.1 INSTALLATION TEST

After connecting the SEHI to the network, verify that packets pass between all Ethernet devices connected to the SEHI and any other devices connected to the network. If there is a problem with any of the attached devices, check the link as follows:

1. Check that the **LNK** LED, if applicable, for the port is on. If the LED is not on:
 - a. Check that the 100BASE-TX device at the other end of the twisted pair segment is powered up.
 - b. Verify that the connector on the twisted pair segment has the proper pinouts. Refer to Chapter 3 for the pin assignments for twisted pair connectors.
 - c. For the EPIM-100FX check that the TX and RX fibers are properly connected.
 - d. Check the cable for continuity. Several tools are available for this test, depending on the media used.
 - e. Check that the twisted pair segments meet cable specifications for dB loss as described in Chapter 3.

2. If the remote station is ready and the **LNK** LED is on, but no data passes through the port, one of two conditions may exist:
 - Network management has disabled the port. Correct this condition by enabling the port through network management.
 - The port is segmented either because the collision detector was on for more than 110 μ s or the SEHI detected more than 32 consecutive collisions on the attached segment. The affected port remains segmented until a good packet is transmitted/received without collisions.

If the **LNK** LED is still not on, contact Cabletron Systems Technical Support.

6.2 USING LANVIEW

The SEHI incorporates the Cabletron Systems LANVIEW status monitoring and diagnostics system. LANVIEW LEDs help diagnose problems such as power failure or cable fault. The SEHI includes the following LANVIEW LEDs:

- **PWR**, for power status
- **CPU**, for board status
- **RCV** (Receive), **LNK** (Link), and **CLN** (Collision) for Ethernet status.

Figure 6-1 provides a quick reference chart of LED locations and definitions. This chapter also includes a detailed description of each LED.

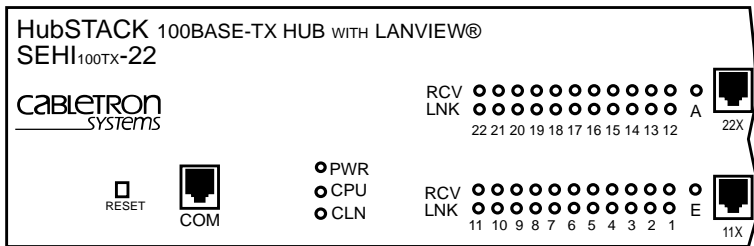

LED NAME	LED COLOR	DEFINITION
PWR (Power)	Off Green (Solid)	No power Power
CPU (Central Processing Unit)	Off Green (Flashing) Green (Blinking) Red (Solid)	CPU in BOOT process CPU initializing CPU functioning CPU not functioning
CLN (Collision)	Red	Collision
RCV (Receive)	Yellow (Flashing) Off	SEHI is receiving data No activity
LNK (Link)	Green Off	Link established No link

1511_13

Figure 6-1 LANVIEW LEDs

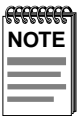

Flashing indicates an irregular LED pulse.

Blinking indicates a steady LED pulse.

PWR

When this green LED is on, it indicates that the SEHI is receiving power. If this LED is off, it indicates a loss of input power. Check the input power source (circuit breaker, fuse, etc.). If the proper source power is present, the problem could be with the SEHI.

CPU

This LED alternates from red to green to during power up. After the boot is complete, the LED blinks green. A blinking green LED indicates normal operation. A red LED indicates a faulty processor.

CLN

This red LED indicates that a collision has occurred on one of the ports.

RCV

When a yellow RCV LED flashes, it indicates that the SEHI is receiving data packets from the associated port segment. Each SEHI port has a corresponding RCV LED:

- Network Ports: RCV LEDs 1-22
- EPIM 1: RCV LED E
- Management A

LNK

When a green LNK LED is on, it indicates an established link between the associated port and the device at the other end of the segment. The LNK LED remains on as long as a link is maintained. Each SEHI Network Port (ports 1-22) has a corresponding LNK LED.

6.3 USING THE RESET BUTTON

The SEHI incorporates a recessed RESET button. See Figure 6-1. The RESET button initializes the SEHI processor. This button does NOT initialize Non-Volatile Random Access Memory (NVRAM), the nonvolatile random access memory where the SEHI stores network management parameters.

To use the RESET button, use a pen or pencil to press the button. When this is done, the SEHI initializes itself.



All modules in a stacked configuration reset when the SEHI is reset.

6.4 SETTING THE NVRAM SWITCH



To prevent the possibility of electrical shock, **do not** remove the chassis cover to access the NVRAM switch, and use only a **non-metallic** tool when moving the NVRAM switch.

The SEHI uses NVRAM (Non-Volatile Random Access Memory) to store user-entered parameters such as IP address and Community Names. To reset these parameters to the factory defaults, refer to Figure 6-2 and perform the following steps:

1. With the power ON and using a **non-metallic** tool, move the NVRAM switch to the UP position.
2. Press the RESET switch located on the front panel.
3. Wait until the unit boots (approximately 12 seconds).
4. Return the NVRAM switch to the DOWN position.



Failure to return the NVRAM switch to the DOWN position will result in loss of user-entered parameters upon power shutdown and restart. The SEHI will clear NVRAM if the unit is restarted with the switch in the UP position.

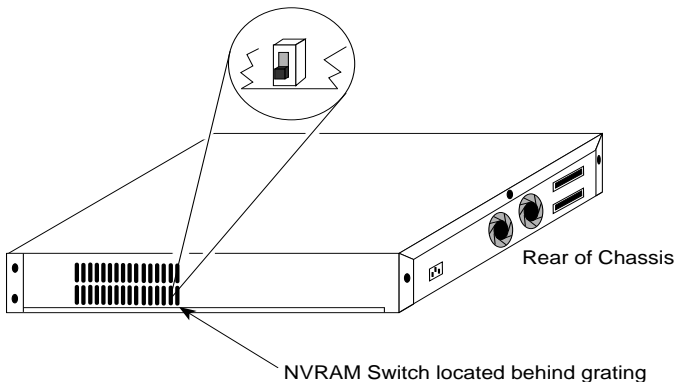

1511_02

Figure 6-2 NVRAM Switch Location

CHAPTER 7

LOCAL MANAGEMENT

This chapter explains how to set up a management terminal to access the SEHI Local Management. It also explains how to use the Local Management screens and commands.

Local Management supplies the tools to manage the SEHI and all of its attached segments. It allows the user to perform the following tasks:

- Assign an IP address and subnet mask
- Select a default gateway
- Control access to the SEHI through the community names established in the Community Name Table
- Designate which Network Management Workstations receive trap messages from the device
- Navigate through the Management Information Base (MIB) and manage the objects within it from a remote location. Given the appropriate security level, the MIB is accessible from the SEHI through SNMP Tools.

Local Management also allows the user to manage each non-intelligent stackable hub attached to the SEHI, and provides a Statistics screen to view error, collision, and traffic statistics for the entire stack, individual module, or individual port.

7.1 LOCAL MANAGEMENT KEYBOARD CONVENTIONS

All key names appear in this manual as capital letters. For example, the enter (return) key appears as ENTER and the space bar appears as SPACE bar. Table 7-1 explains the keyboard conventions used in this manual as well as the key functions.

Table 7-1 Keyboard Conventions

Key	Function
RETURN Key and ENTER Key	These are selection keys that perform the same Local Management function. For example, "Press ENTER" means press either ENTER or RETURN, unless this manual specifically instructs you otherwise.
SPACE bar and BACKSPACE Key	These keys cycle through selections in some Local Management fields. Use the SPACE bar to cycle forward through selections and use BACKSPACE to cycle backward through selections.
Arrow Keys	These are navigation keys. Use the UP-ARROW, DOWN-ARROW, LEFT-ARROW, and RIGHT-ARROW keys to move the screen cursor. For example, "Use the arrow keys" means to press whichever arrow key moves the cursor to the desired field on the Local Management screen.

7.2 MANAGEMENT TERMINAL SETUP

Use one of the following systems to access Local Management:

- A Digital Equipment Corporation VT series terminal
- A VT type terminal running emulation programs for the Digital Equipment Corporation VT series
- An IBM or compatible PC running a VT series emulation software package

An RJ45 console cable is required to attach the management terminal to the SEHI. The console cable is included with the SEHI in a package that contains the following:

- UTP console cable with RJ45 connectors on each end
- Adaptors for DB9 or DB25 connections
- Instruction sheet

The following sections explain how to attach the console cable and set up the management terminal. Refer to the RJ45 Cable Kit Instruction Sheet for adapter pinouts and additional information.

Console Cable Configuration

Use the RJ45 Cable Kit provided with the SEHI to attach the management terminal to the SEHI COM port as shown in Figure 7-1.

Connect the console cable to the SEHI as follows:

1. Attach the male RJ45 connector to the COM port of the SEHI.
2. Attach the female end (25-pin or 9-pin, as applicable) to the COM port on the terminal.

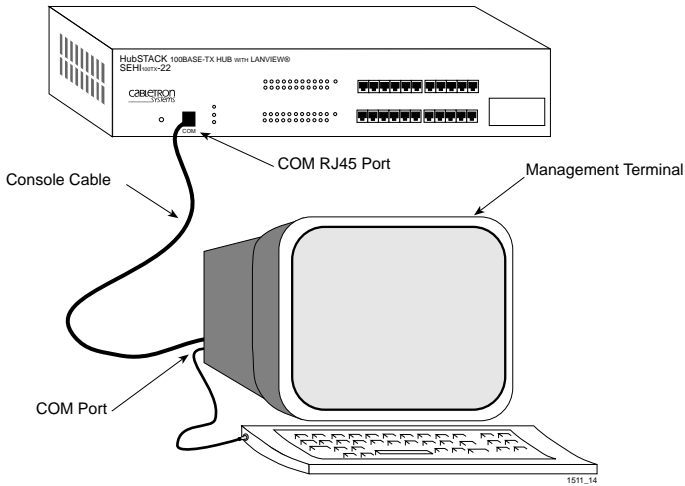

Figure 7-1 Management Terminal Connection

Management Terminal Setup Parameters

Table 7-2 lists the setup parameters for the local management terminal. If the terminal is a Digital Equipment Corporation VT320 terminal, press **F3** to access the Setup Directory. If the local management terminal uses terminal emulation of the VT320, refer to the equipment user manual for setup procedures.

Table 7-2 Terminal Setup Parameters

Menu	Function	Selection
Display Setup:	Columns	80 Columns
	Controls	Interpret Controls
	Auto Wrap	No Auto Wrap
	Test Cursor	Cursor
General Setup:	Mode	7 Bit Control
	Cursor Keys	Normal Cursor Keys
Communications Setup:	Transmit	Transmit = 9600
	Receive	Receive = Transmit
	XOFF	any option
	Bits, Parity	8 Bits, No Parity
	Stop Bit	1 Stop Bit
	Local Echo	No Local Echo
	Port	DEC-423, Data Leads Only
	Transmit	any option
Keyboard Setup:	Auto Answerback	No Auto Answerback
	Auto Repeat	any option
	Keyclick	any option
	Margin Bell	Margin Bell
	Warning Bell	Warning Bell
	Auto Answerback	No Auto Answerback

7.3 ACCESSING LOCAL MANAGEMENT

After configuring the local management terminal and properly attaching the cables to the SEHI, access the Local Management interface.

Use the following steps to access Local Management:

1. Power up the terminal. The Password screen (Figure 7-2) appears.

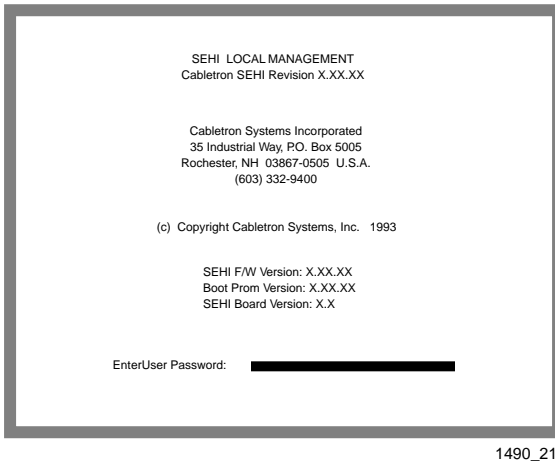
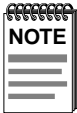

Figure 7-2 Password Screen

2. Enter the **Password**. The factory default password for Super-User access is “public” or press **ENTER**.



The password is one of the community names specified in the Community Name Table. Access to certain Local Management capabilities depends on the degree of access accorded that community name. See Section 7.5 for more details about community names.

3. Press **ENTER**.
 - If the password entry is invalid, the cursor returns to the beginning of the password entry field.
 - If the password is valid, the associated access privilege appears briefly, then the Feature Selection screen (Figure 7-3) appears.

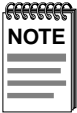

If the terminal keyboard is not used for 15 minutes, the Local Management session ends and the screen defaults to the Password screen.

7.4 THE FEATURE SELECTION SCREEN

The Feature Selection screen is the main menu screen for SEHI Local Management. There are five screen options in the Feature Selection screen: Community Name Table, IP Address Assignment, Component Trap Table, SNMP Tool Support, and Device Statistics. Use the arrow keys to highlight an option, then press **ENTER** (or press the corresponding **Function Key**). The selected screen appears.

To exit your Local Management session, use the arrow keys to highlight the **EXIT LIM SERVICE** command, then press **ENTER**.

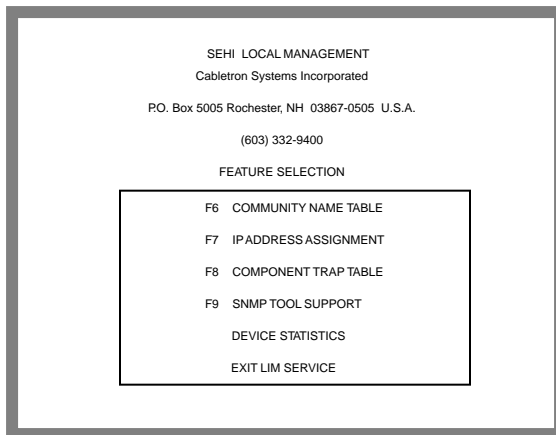

1490_22

Figure 7-3 Feature Selection Screen

7.5 THE COMMUNITY NAME TABLE SCREEN

To access the Community Name Table screen from the Feature Selection screen, use the arrow keys to highlight the **Community Name Table** option, then press **ENTER** or **F6**. The Community Name Table screen shown in Figure 7-4 appears.

SEHI LOCAL MANAGEMENT				
Cabletron SEHI Revision X.XX.XX				
COMMUNITY NAME TABLE				
COMMUNITY NAME		ACCESS		
PUBLIC				BASIC-READ
PUBLIC				READ-ONLY
PUBLIC				READ-WRITE
PUBLIC				SUPER-USER
SAVE	IP TABLE	TRAP TABLE	SNMP TOOLS	RETURN
F6	F7	F8	F9	

1490_23

Figure 7-4 Community Name Table Screen

Community names are set through the Community Name Table option. Community names are passwords to Local Management and are agents of security control to the SEHI. SEHI access is controlled by establishing up to four different levels of security authorization: Basic-Read, Read-Only, Read-Write, and Super-User.

With Super-User access, the user changes the existing passwords by changing the community names. Only the community name assigned Super-User access has full management privileges.

The following sections explain each field on the Community Name Table screen and provides instructions on how to change them.

COMMUNITY NAME

Displays the user-defined name through which a user can access Local Management for the SEHI. Any community name assigned here acts as a password to Local Management.

ACCESS

Indicates the access status accorded each community name. The following conditions are possible:

Basic-Read	This allows Read-Only access to Local Management, but excludes read privileges to the Component Trap screen.
Read-Only	This allows Read-Only access to Local Management, but excludes access to security protected fields of the upper levels of authorization (Read-Write or Super-User).
Read-Write	This allows the user to read and write to Local Management fields, excluding IP Address, Subnet Mask, and Community Names.
Super-User	This access privilege gives the user read and write access to Local Management. Super-User allows read and write access to all modifiable parameters including: Community Names, IP Addresses, Traps, and SNMP Objects.

7.5.1 Editing the Community Name Field

The password used to access Local Management at the Password screen must have Super-User privileges for the edits to take effect. If a password is entered with Basic-Read, Read-Only, or Read-Write privileges, Local Management displays the message “AUTHORIZATION PROHIBITS ACCESS”, and does not include editing capabilities.

Use the following steps to edit the Community Name field:

1. Use the arrow keys to highlight the **Community Name** field adjacent to the desired access level.
2. Enter the community name (maximum of 32 characters) into the field.
3. Press **ENTER**.
4. Repeat steps 1-3 for editing any of the other community names.
5. Use the arrow keys to highlight the **SAVE** command at the bottom of the screen, then press **ENTER** or **F6**. The “**SAVED OK**” message appears indicating that the edits have been saved to memory.

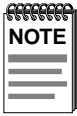

The first time a user attempts to exit the screen without saving the changes, a “NOT SAVED?” message is displayed. The edits are lost if the user proceeds to exit without saving the changes.

6. To exit the screen, press the appropriate Function key or use the arrow keys to highlight the RETURN command.
7. Press **ENTER**. The Feature Selection screen appears.

7.6 THE CONFIGURATION SCREEN

To access the Configuration screen from the Feature Selection screen, use the arrow keys to highlight the **IP Address Assignment** option, then press **ENTER** or **F7**. The screen shown in Figure 7-5 appears.

I/F	IP Address	SubNET Mask	MAC Address
1	000.000.000.000	000.000.000.000	00-00-1d-05-dc-36

Default Gateway: 0.0.0.0

Serial Port 1 Application: CONSOLE Baud Rate: 9600 --ACTIVE--

Port Enable Override: OVERRIDE DISABLED

SAVE COMMUNITY NAMES TRAP TABLE SNMP TOOLS RETURN

F6 F7 F8 F9

1490_24

Figure 7-5 Configuration Screen

Assign the IP Address, Subnet Mask, and Default Gateway through the SEHI Configuration screen. Use the Port Enable Override option to enable all device ports in the stack. This option overrides the Port Disable setting in the Statistics screen.

The following sections explain each field on the Configuration screen and instructions on how to change them.

I/F

The number of the interface corresponding to the channels over which packets with that IP Address pass. On the SEHI, this value is always 1.

IP Address

Displays the IP address of the SEHI.

SubNET Mask

Displays the subnet mask for the SEHI. A subnet mask is a 32-bit quantity which “masks out” the network bits of the IP address. This is done by setting the bits in the mask to 1 when the network treats the corresponding bits in the IP address as part of the network or subnetwork address, or to 0 if the corresponding bit identifies the host.

MAC Address

Displays the physical address associated with the interface.

Default Gateway

Displays the default gateway for the SEHI. This field is not defined until an appropriate value is entered. The default gateway identifies the default gateway device that will forward packets to other IP subnetworks.

Serial Port 1 Application

Displays the port's application setting as CONSOLE.

Baud Rate

Displays the Baud Rate setting of the device attached to the SEHI through the serial port. The setting for the serial port is 9600.

Port Enable Override

This command lets the user override the Disable Port settings in the Device Statistics screen to enable all ports in the stack.

7.6.1 Setting the IP Address

Use the following steps to set the IP address:

1. Use the arrow keys to highlight the **IP Address** field.
2. Enter the IP address into this field. The format for this entry is XXX.XXX.XXX.XXX, with values for XXX being from 0 to 255. The screen beeps if non-numeric or adjacent dots are entered. If the entry does not have three dots it will be rejected.
3. Press **ENTER**. The IP address appears and the natural subnet mask for the user is generated and also appears.
4. Use the arrow keys to highlight the **SAVE** option, then press **ENTER** or **F6**. The “SAVED OK” message appears indicating that the changes have been saved to memory.



The first time an attempt is made to exit the screen without saving the changes, a “NOT SAVED?” message is displayed. The edits are lost if the user proceeds to exit without saving the changes.

7.6.2 Setting the Subnet Mask



Consult the Network Administrator prior to setting the Subnet Mask.

The subnet mask defines how the SEHI treats SNMP Trap IP destination addresses in its Trap Table.

- Set the subnet mask when workstations in the Trap Table reside on a different subnet (i.e., across a gateway or router), and these workstations are to receive SNMP traps.
- Use the subnet mask factory default setting of 0.0.0.0 when all trap designated workstations are on the SEHI subnet.

Use the following steps to set the subnet mask:

1. Use the arrow keys to highlight the **SubNET Mask** field.

2. Enter the subnet mask into this field. The format for this entry is XXX.XXX.XXX.XXX with values for XXX being from 0 to 255.
3. Press **ENTER**.
4. Use the arrow keys to highlight the **SAVE** option, then press **ENTER** or **F6**. The “SAVED OK” message appears indicating that the changes have been saved to memory.

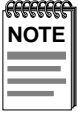

The first time an attempt is made to exit the screen without saving the changes, a “NOT SAVED?” message is displayed. The edits are lost if the user proceeds to exit without saving the changes.

7.6.3 Setting the Default Gateway

The Default Gateway field allows the user to describe the router through which the SEHI will be forwarding IP packets.

Use the following steps to set the Default Gateway:

1. Use the arrow keys to highlight the **Default Gateway** field.
2. Enter the gateway’s default mask in this field. The format for this entry is XXX.XXX.XXX.XXX with values for XXX being from 0 to 255.
3. Press **ENTER**. If your entry is accepted as a valid default gateway, “OK” appears to the right of the field.
4. Use the arrow keys to highlight the **SAVE** option, then press **ENTER** or **F6**. The “SAVED OK” message appears indicating that the changes have been saved to memory.

7.6.4 Using the Port Enable Override

Use the following steps to override the Disable Port settings:

1. Use the arrow keys to highlight the **Port Enable Override** field.
2. Press **ENTER** to toggle from the default setting of “OVERRIDE DISABLED” to “OVERRIDE ENABLED”.
3. The adjacent field displays “Y/N”. Enter **Y** to continue enabling all of the ports, or **N** to discontinue the port enable override. The message “PORT ENABLED” appears after **Y** is entered.

7.6.5 Exiting the Configuration Screen

Use the following steps to exit the Configuration screen and return to the Feature Selection screen:

1. Press the appropriate Function key. To return to the Feature Selection screen, use the arrow keys to highlight the **RETURN** command.
2. Press **ENTER**. The Feature Selection screen appears.

7.7 THE TRAP TABLE SCREEN

Access the Trap Table screen from the Features Selection screen using the arrow keys to highlight the **Component Trap Table** option, then press **ENTER** or **F8**. The screen shown in Figure 7-6 appears.

SEHI LOCAL MANAGEMENT				
Cabletron SEHI Revision X.XX.XX				
TRAP TABLE				
SNMP Community Name	Traps	IP Address		
<CR>	N	0.0.0.0		
<CR>	N	0.0.0.0		
<CR>	N	0.0.0.0		
<CR>	N	0.0.0.0		
<CR>	N	0.0.0.0		
<CR>	N	0.0.0.0		
<CR>	N	0.0.0.0		
<CR>	N	0.0.0.0		
SAVE	COMMUNITY NAMES	IP TABLE	SNMP TOOLS	RETURN
F6	F7	F8	F9	

1490_25

Figure 7-6 Trap Table Screen

The Trap Table defines the management stations that receive SNMP Traps for alarm/event notification. The following sections explain each field on the Trap Table screen and provide instructions on how to change them.

SNMP Community Name

Displays the community name included in the trap message sent to the Network Management Station with the associated IP address.

Traps

Enables transmission of the traps to the network management station with the associated IP address.

Trap IP Address

Indicates the IP address of the workstation to receive trap alarms from the SEHI.

7.7.1 Configuring the Trap Table

Use the following steps to configure the Trap Table:

1. Use the arrow keys to highlight the **SNMP Community Name** field, then enter the community name.
2. Press **ENTER**.
3. Use the arrow keys to highlight the **Traps** field and enter **Y** to send alarms from the SEHI to the workstation, or **N** to prevent alarms from being sent.
4. Press **ENTER**.
5. Use the arrow keys to highlight the appropriate **Trap IP Address** field.
6. Enter the IP address of the workstation that you want to send traps to in this field. The format for this entry is XXX.XXX.XXX.XXX, with the value of XXX ranging from 0 to 255, and three dots, or else it returns to the beginning of the field.
7. Use the arrow keys to highlight the **SAVE** option, then press **ENTER** or **F6**. The “SAVED OK” message appears indicating that the changes have been saved to memory.

7.7.2 Exiting the Trap Table Screen

Use the following steps to exit the Trap Table screen and return to the Feature Selection screen:

1. Press the appropriate Function key. To exit to the Feature Selection screen, use the arrow keys to highlight the **RETURN** command.
2. Press **ENTER**. The Feature Selection screen appears.

7.8 THE SNMP TOOLS SCREEN

This section describes how to use the SNMP Tools screen to access Management Information Bases (MIBs). Access to screen options depends on the access status accorded to the user's community name. This section describes Super-User management capabilities.

SNMP Tools allows access to valuable MIB information. The user gets information about specific object identifiers (OIDs), edit the values of configurable OIDs, and request the OID numerically sequential to the originally requested OID.

Other ways to view OIDs from the SNMP Tools screen include Walking, Stepping, and Cycling. Walk and Cycle let the user review several OIDs at a time.

To access the SNMP Tools screen from the Features Selection screen, use the arrow keys to highlight the **SNMP Tools Support** option, then press **ENTER** or **F9**. The SNMP Tools screen shown in Figure 7-7 appears.

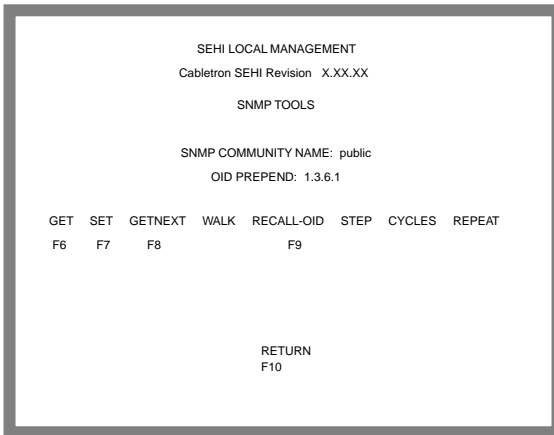

1490_26

Figure 7-7 SNMP Tools Screen

The following sections describe SNMP Tools screen fields.

SNMP COMMUNITY NAME

Identifies the community name used as a password to determine access level to the MIB component.

OID PREPEND

Specifies the number prefix common to all Object Identifiers (OIDs) found in the MIBs – 1.3.6.1 is the default prefix OID. This is a modifiable field.

GET

Lets you retrieve MIB objects using SNMP protocol.

SET

Allows users with Read-Write and Super-User access to change modifiable MIB objects, using SNMP protocol.

GETNEXT

Displays the OID following the current OID.

WALK

Allows the user to scroll through a section of the MIB leaf by leaf, from a user-specified object identifier. Leaves are the sections of the OID separated by periods. When a walk is initialized, the following categories for each walk entry, or step are displayed.

- Specified OID – gives the number tag for that OID.
- Size – identifies the number of bytes it takes to store that object.
- Type – specifies the variable type of the object (e.g., int = integer).
- Data – displays what the object identifier represents.

Recall-OID

Recalls, from memory, the last OID used.

STEP

Displays the MIB walk, step by step, giving the user time to view specific leaves in detail.

CYCLES

Allows the user to specify the number of GETNEXT requests to cycle through and how much time will elapse between each request.

REPEAT

Repeats the last GET command, allowing the user to monitor changes to a specific OID.

7.8.1 Getting Individual OIDs

Use the following steps to GET an OID:

1. Highlight **GET**, using the arrow keys, then press **ENTER** or **F6**.
“<GET> OID (=|F9)” appears.
2. Use one of the following options to enter the OID:
 - Enter the OID minus the prepend (e.g., if the prepend is 1.3.6.1, and 4.1.3 is entered, then the OID=1.3.6.1.4.1.3).
 - Enter an “=” and the OID suffix (e.g., if =4.1.3 is entered, then the OID=4.1.3). This allows the user to not use the prepend.
 - Press **F9** to recall an OID already entered. The user can then use the keyboard to modify the recalled OID as necessary.
3. Press **ENTER**. If there is no instance of that OID, the return code will specify “MIB_NO_INSTANCE”, otherwise, information about that OID data type, length, and value appear.

7.8.2 Getting the Next OID

Use the following steps to GET the next OID:

1. Highlight **GETNEXT** with the arrow keys, then press **ENTER** or **F8**.
“<GETNEXT> OID (=|F9)” appears.
2. Enter the desired **OID**, or OID extension. (Press F9 to recall the last OID request. The recalled OID may then be modified as necessary.)
3. Press **ENTER**. If there is no instance of that OID, the return code specifies “MIB_NO_INSTANCE”, otherwise, information about the data type, length, and value of that OID appear.

7.8.3 Setting an OID

Use the following steps to SET an OID:

1. Highlight **SET** by using the arrow keys, then press **ENTER** or **F7**.
“<SET> OID (=|F9)” appears.
2. Enter the OID, minus the OID prepend. If the OID was previously entered, pressing **F9** recalls that entry. The arrow keys may be used to modify the recalled OID if necessary.

3. Press **ENTER**. If there is no instance of that OID, the return code will specify “MIB_NO_INSTANCE”, otherwise “DATA TYPE:” appears.
4. Enter the data type for that OID. The following are possible choices: integer, string, null, OID, IP address, counter, gauge, timeticks, and opaque.
5. Press **ENTER**. “DATA” appears.
6. Enter the value to correspond to the OID. If accepted, “<SET> OPERATION CODE: XXXX <OK>” appears, otherwise an error message appears.

7.8.4 Viewing Multiple OIDs

Viewing several object identifiers at one time allows the user to quickly scan a MIB for the specific information that is needed. The **WALK** command scrolls through OIDs numerically sequential to the initial OID request. The **STEP** command scrolls the MIB Walk, one OID at a time. Cycling allows you to specify how many **GETNEXT** commands to cycle through for one OID.

7.8.5 Walking Through OIDs

Use the following steps to **WALK** through an OID:

1. Highlight **WALK**, using the arrow keys, then press **ENTER**. “<INITIAL> OID (=|F9)” appears.
2. Enter the OID (minus the prepend) and press **ENTER**. The screen will begin walking through the sublayers of the MIB available from the specified OID. Each OID listed displays the specified OID, its size, its type, and the data it contains.
3. Press the **SPACE** bar to stop the walk, or wait for “***MIB WALK COMPLETED***” to appear on the screen.

7.8.6 Stepping Through OIDs

Use the following steps to STEP through OIDs (the user can step through only after a GETNEXT):

1. Highlight **STEP**, using the arrow keys, then press **ENTER**. “Specify OID” appears.
2. Enter the OID (only the suffix is necessary) and press **ENTER**. The Tools screen will begin to scroll one OID at a time, through all of the sublayers of the MIB available for that OID.

7.8.7 Cycling Through OIDs

Use the following steps to CYCLE through an OID:

1. Use the arrow keys to Highlight **CYCLES**, then press **ENTER**.
2. Enter the number of cycles desired to occur after “ENTER CYCLE COUNT:”, then press **ENTER**.
3. Enter how many seconds delay desired between get next requests after “ENTER CYCLE DELAY (secs):”, then press **ENTER**.

7.8.8 Exiting the SNMP Tools Screen

To exit the SNMP Tools Screen:

1. Use the arrow keys to highlight the **RETURN** command.
2. Press **ENTER**. The Feature Selection screen appears.

7.9 THE DEVICE STATISTICS SCREEN

This section describes the features of the Device Statistics screen. The user can view error, collision, and traffic statistics for the stack, a selected module, or a selected port. The user can also enable and disable ports.

To access the Statistics screen from the Features Selection screen, use the arrow keys to highlight the **Device Statistics** option, then press **ENTER**. The Device Statistics screen shown in Figure 7-8 appears.

SEHI LOCAL MANAGEMENT			
Cabletron SEHI Revision X.XX.XX			
DEVICE STATISTICS			
	STACK TOTAL	MODULE: 1	PORT 1
BYTES RECEIVED:	3792125	67960	67960
FRAMES RECEIVED:	16547	255	255
ERRORS RECEIVED:	0	0	0
COLLISIONS:	0	0	0
OOV COLLISIONS:	0	0	0
CRC ERRORS:	0	0	0
ALIGNMENT ERRORS:	0	0	0
RUNT PACKETS:	0	0	0
GIANT PACKETS:	0	0	0
PORT ADMIN. STATUS:	0	0	
PORT SEG. STATUS:			ENABLE UNSEGMENTED
ENABLE PORT	DISABLE PORT		
UPDATE -FREQ 3 Sec	MODULE 1	PORT 1	RETURN

1490_27

Figure 7-8 Device Statistics Screen

The following sections describe Device Statistics screen fields and provide instructions on how to change them.

BYTES RECEIVED

Displays the number of bytes received.

FRAMES RECEIVED

Displays the number of frames received.

ERRORS RECEIVED

Displays the number of errors received.

COLLISIONS

Displays the number of collisions received.

OOW COLLISIONS

Displays the number of Out Of Window collisions. OOW collisions are usually caused by the network being too long where the round trip propagation delay is greater than 51.2 μ s (the collision domain is too large), a station somewhere on the network is violating Carrier Sense and transmitting at will, or a cable somewhere on the network failed during the transmission of the packet.

CRC ERRORS

Displays the number of packets with bad Cyclic Redundancy Checks (CRC) that have been received from the network. The CRC is a 4-byte field in the data packet that ensures that the transmitted data that is received is the same as the data that was originally sent.

ALIGNMENT ERRORS

Displays the number of errors due to misaligned packets.

RUNT PACKETS

Displays the number of runt packets received from the network. A runt packet is less than the minimum Ethernet frame size of 64 bytes, not including preamble.

GIANT PACKETS

Displays the number of packets received that exceed 1518 data bytes, not including preamble.

PORT ADMIN. STATUS

Displays the administrative status of the port selected. The two possible status messages are Enable or Disable.

PORT SEG. STATUS

Displays the segmentation status of the port selected. The two possible status messages are Segmented or Unsegmented. The SEHI and SEH automatically partition problem segments, and reconnect non-problem segments to the network.

ENABLE PORT

This command lets the user enable the selected port.

DISABLE PORT

This command lets the user Disable the selected port.

UPDATE-FREQ

This command lets the user select the time interval between Stack/Module/Port counter updates. Choose update intervals in increments of 3 seconds, with the maximum interval being 99 seconds.

MODULE

This command lets the user view statistics for a selected module in the stack. The SEHI is Module 1 and each SEH in the stack follows in sequential order. Figure 7-9 shows each module number in the stack.

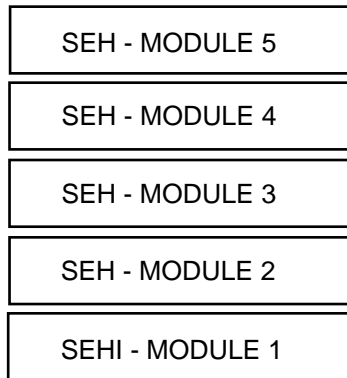

Figure 7-9 Module Number Sequence

PORT

Allows the user to view statistics for ports 1–24 of the selected module.

7.9.1 Selecting the Appropriate Module/Port

When the Device Statistics screen first appears, statistics are displayed for Module 1 and Port 1. View statistics for another module and port by using the **Module x** or **Port x** commands at the bottom of the screen.

Use the following steps to select a module or port:

1. Use the arrow keys to highlight the Module or Port command.
2. Press the **SHIFT** and + or - keys until the desired module or port number appears.
3. Press **ENTER**. The selected Module and Port statistics appear.

7.9.2 Using the ENABLE PORT Command

The ENABLE PORT command lets the user enable the selected port. The user must first use the **PORT** command to select the desired port.

Use the following steps to set the PORT ENABLE command:

1. Use the arrow keys to highlight the **ENABLE PORT** command at the bottom of the screen.
2. Press **ENTER**. The corresponding port is enabled and the Port Admin Status field is updated.

7.9.3 Using the DISABLE PORT Command

The DISABLE PORT command lets the user disable the port selected in the PORT command. The user must first use the PORT command to select the desired port.

Use the following steps to set the DISABLE PORT command:

1. Use the arrow keys to highlight the **DISABLE PORT** command at the bottom of the screen.
2. Press **ENTER**. The corresponding port is disabled and the Port Admin Status field is updated.

7.9.4 Exiting the Device Statistics Screen

Use the following steps to exit the Device Statistics screen and return to the Feature Selection screen:

1. Use the arrow keys to highlight the **RETURN** command at the bottom of the screen.
2. Press **ENTER**. The Feature Selection screen appears.

APPENDIX A

EPIM SPECIFICATIONS

A.1 EPIM SPECIFICATIONS

EPIMs enable the connection of the SEHI to the network using different media types. The SEHI100TX-22 supports the EPIM-100TX and the EPIM-100FX. This appendix provides specifications for each EPIM.

A.1.1 EPIM-100TX

The EPIM-100TX is an RJ45 connector supporting Unshielded Twisted Pair (UTP) cabling.

The slide switch on the EPIM-100TX determines the cross-over status of the cable pairs. If the switch is on the **X** side, the pairs are internally crossed over. If the switch is on the **=** side, the pairs are not internally crossed over. Figure A-1 shows the pinouts for the EPIM-100TX in both positions.

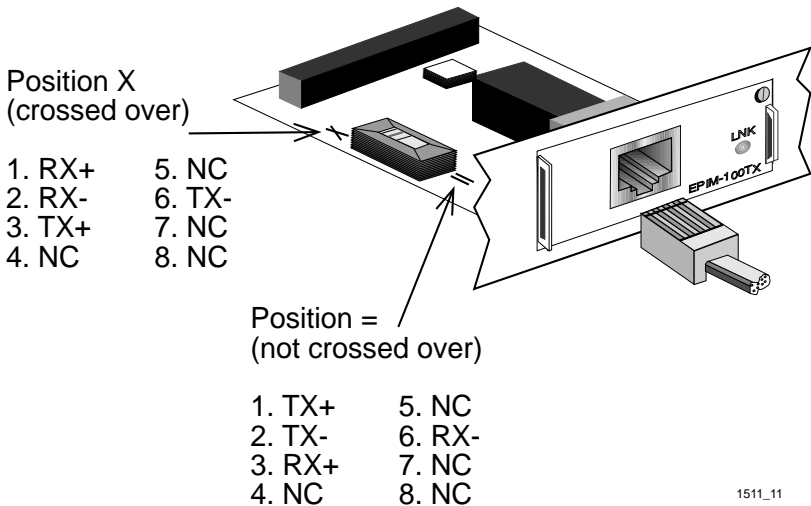

Figure A-1 EPIM-100TX Pinouts

A.1.2 EPIM-100FX

The EPIM-100FX shown in Figure A-2 supports Multimode Fiber Optic cabling. The EPIM-100FX is equipped with an SC style connector. Specifications for the EPIM-100FX are listed below.

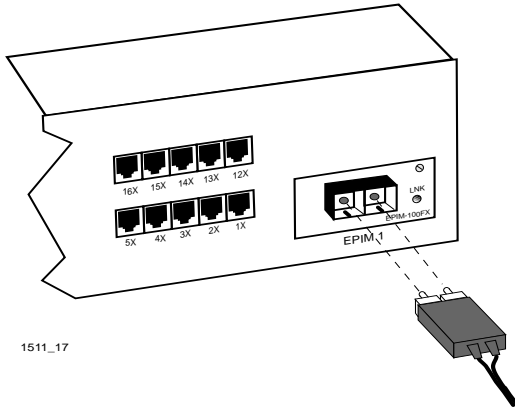

Figure A-2 EPIM-100FX

Table A-1 Transmitter Power

Cable Type	Worst Case Budget	Typical Budget
50/125 μm fiber	6.0 dB	9.0 dB
62.5/125 μm fiber	9.0 dB	12.0 dB
100/140 μm fiber	15.0 dB	18.0 dB

The transmitter power levels and receive sensitivity levels listed are peak power levels after optical overshoot. A peak power meter must be used to correctly compare the values given above to those measured on any particular port. If power levels are being measured with an average power meter, add 3 dBm to the measurement to compare the measured values to the values listed above.

APPENDIX B

IMAGE FILE DOWNLOAD USING OIDS

This appendix provides instructions for setting up a TFTP server and to download an image file to the SEHI by setting specific MIB OID strings. Set the OID strings with the SNMP Tools screen described in Chapter 7.

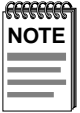

Download an image file to the SEHI with a remote management package such as SPECTRUM, SPECTRUM Element Manager, or the appropriate SPECTRUM Portable Management Application. Refer to the specific package documentation for image file download procedures.

The SEHI supports the Standard Local Download application. In this application the SEHI automatically disables management while download of the new firmware image is in progress.

Before downloading the image to a device, you must do the following:

- Load the image file onto your network TFTP server.



For information on how to setup a workstation as a TFTP server, refer to your specific workstation documentation and the guidelines outlined in this instruction guide.

- Decompress the image file.

B.1 SETTING UP A UNIX WORKSTATION AS A TFTP SERVER

Due to variations between UNIX systems and individual configurations, this section provides only GUIDELINES for configuring a UNIX workstation to perform an image file download. The instructions include command examples, where appropriate. Bold lettering in examples indicates operator entry.



If unsure about how to properly configure your UNIX workstation using these guidelines, contact your Systems Administrator.



Due to variations between UNIX systems, and individual configurations, this section provides only GUIDELINES for configuring a UNIX workstation to perform an image file download. The instructions include command examples, where appropriate. Bold lettering in examples indicates operator entry.

Downloading an image file requires setting up your UNIX workstation as a TFTP server.

Use the following steps to set up a UNIX workstation:

1. If you already have a /tftpboot directory, confirm the TFTP setup of your workstation as follows:

Request a process status and grep for TFTP
(e.g., `unix% netstat -a | grep tftp`).

The following information represents a typical output:

```
user  161  7.7  1.2  32  184  p3  S  12:00  grep tftp
root  87   0.0  0.9  48  136  ?   S  11:05  tftp -s
```

The term `tftp -s`, located at the end of the root string, indicates TFTP is active. If TFTP is NOT running, only the `grep` process appears.

2. If you do NOT have a /tftpboot directory, then create one
(e.g., `unix% mkdir tftpboot`).

3. Ensure that the /tftpboot directory is not owned (e.g., `unix% chown nobody tftpboot`).
4. Store the hex image file in the /tftpboot directory as `sehi.hex`.



This step requires decompression of the zipped image file. If you do not have a UNIX unzip utility, access to a PC with `pkunzip`, or a way to FTP the decompressed image to a UNIX workstation, contact Cabletron Systems Technical Support.

5. Edit the `/etc/inetd.conf` file by removing anything prior to the `tftpboot` daemon (e.g., the `#` sign) that comments-out the line.
6. Kill the `inetd` process (e.g., `unix% kill -HUP 'process ID number'`), and then restart the process (e.g., `unix% inetd`), to enable the revised `inetd.conf` file.

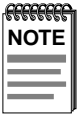

You must request a process status and `grep` for `inetd` to obtain the process ID number (see step 3 above).

B.2 STANDARD LOCAL DOWNLOAD

Table B-1 provides a step-by-step procedure for downloading the firmware image file. This section provides specific MIB OIDs, their names, and the required setting for proper image file download. Refer to your specific MIB walking tool documentation for instructions on how to set MIB OID strings.

The Download OIDs for Cabletron Systems products reside in the Cabletron Systems enterprise MIBs (group 52). The specific OIDs necessary to perform an image file download reside in the common download group under `ctDL` (Cabletron Download). The full OID string to reach this group is: `1.3.6.1.4.1.52.4.1.5.8.1`

When performing the steps in Table B-1, keep the following in mind:

- You must follow the steps in order.

Appendix B: Image File Download Using OIDs

- Enter the IP address of the TFTP server in standard dotted decimal notation (e.g., 132.177.118.24).
- Enter the FULL path to the image file in the ctDLTFTPRequest OID, including the name of the image file (e.g., c:\tftpboot\sehi.hex).

Table B-1 OIDs and Settings

Step	OID Name	OID Number	Data Type	SNMP OID Data
1.	ctDLForceOnBoot	1.3.6.1.4.1.52.4.1.5.8.1.1.0	integer	1
2.	ctDLCommitRAMToFlash	1.3.6.1.4.1.52.4.1.5.8.1.2.0	integer	1
3.	ctDLTFTPRequestHost	1.3.6.1.4.1.52.4.1.5.8.1.4.0	IP address	Enter the IP address of the TFTP server.
4.	ctDLTFTPRequest	1.3.6.1.4.1.52.4.1.5.8.1.5.0	string (ASCII)	Enter the path to the image file.
5.	ctDLInitiateColdBoot	1.3.6.1.4.1.52.4.1.5.8.1.3.0	integer	1

INDEX

Numerics

100BASE-TX

- cable length 3-2
- crosstalk 3-2
- impedance 3-2
- jitter 3-2
- noise 3-2
- propagation delay 3-3
- temperature 3-3

C

Cable Specifications 3-1

- UTP and STP 3-2

Cable specifications

- multimode fiber optic 3-3

Com port 3-5

Community name table

- access 7-9
- community name 7-8

Configuration

- baud rate 7-11
- default gateway 7-11
- I/F 7-11
- IP address 7-11
- MAC address 7-11
- port ENABLE override 7-11
- serial port application 7-11
- subnet mask 7-11

D

Default gateway 7-13

Device statistics

- alignment errors 7-22
- bytes received 7-21
- collisions 7-21
- CRC errors 7-22
- disable port 7-22
- enable port 7-22
- errors recieved 7-21
- frames received 7-21
- giant packets 7-22
- module 7-23
- oow collisions 7-22
- port 7-23
- port admin. status 7-22
- port seg. status 7-22
- runt packets 7-22
- update freq 7-23

Device statistics screen 7-21

Dimensions 3-7

E

Environmental requirements 3-6

EPIM installation 4-9

EPIM specifications 2-4

- EPIM-100FX A-2
- EPIM-100TX A-1

F

- FLASH EEPROMs 2-2
- FLASH firmware image 4-1

H

- Help 1-3
- HubSTACK
 - cable requirements 3-1

I

- IP address 7-12

L

- LANVIEW 6-2
 - LEDs 6-3
- Local Management 7-1
 - accessing 7-6
 - community name table 7-8
 - configuration screen 7-10
 - console cable 7-4
 - device statistics 7-21
 - DISABLE port 7-24
 - ENABLE port 7-24
 - port enable override 7-13
 - setting default gateway 7-13
 - setting IP address 7-12
 - setting subnet mask 7-12
 - SNMP tools 7-16
 - terminal requirements 7-3
 - terminal setup 7-5
 - trap table 7-14

N

- Network connection 5-1
 - EPIM-100FX 5-4
 - EPIM-100TX 5-2
 - unshielded twisted pair 5-2
- Network port specifications
 - SEHI100TX-22 3-5
- NVRAM
 - setting 6-5

O

- OIDs 7-16
- Operating specifications 3-6

P

- Port ENABLE override 7-13
- Power supply requirements 3-6

R

- Remote network management 2-4
- Reset 6-4

S

- Safety requirements 3-7
- SEHI features 2-2
- Size
 - dimensions 3-7
- SNMP tools
 - cycles 7-17
 - get 7-17
 - getnext 7-17
 - OID prepend 7-17
 - recall OID 7-17
 - repeat 7-17
 - set 7-17
 - SNMP community name 7-16
 - step 7-17
 - walk 7-17
- SNMP tools screen 7-16
- Subnet mask 7-12

T

- Trap table
 - SNMP community name 7-14
 - trap IP address 7-15
 - traps 7-15
- Trap table screen 7-14
- Troubleshooting 6-1

POWER SUPPLY CORD

The mains cord used with this equipment must be a 2 conductor plus ground type with minimum 0.75 mm square conductors and must incorporate a standard IEC appliance coupler on one end and a mains plug on the other end which is suitable for the use and application of the product and that is approved for use in the country of application.

GERMAN:

Die Netzleitung, die mit diesem Gerät benutzt wird, soll einen zwei Leiter mit Erdleiter haben, wobei die Leiter mindestens 0.75 mm sind, mit einer normalen IEC Gerätesteckdose an einem Ende und einem Gerätestecker am anderen Ende versehen sind, der fuer den Gebrauch und die Anwendung des Gerätes geeignet und der zum Benutzen im Lande der Anwendung anerkannt ist.

SPANISH:

El cable principal de la red eléctrica utilizado con este equipo debe tener 2 conductores y 1 toma de tierra con un mínimo de 0.75 mm² cada uno y necesita tener un aparato de acoplamiento standard IEC en un extremo y un enchufe para el cable principal de la red eléctrica en el otro extremo, lo cual sea adecuado para el uso y aplicación del producto y lo cual sea aprobado para uso en el país de aplicación.

FRENCH:

Le cordon d'alimentation reliant cet appareil au secteur doit obligatoirement avoir deux fils conducteurs de 0.75 mm² minimum et un fil de terre. Il doit également être équipé du côté appareil d'une fiche agréée IEC et du côté secteur, d'une prise adaptée à l'usage du produit et aux normes du pays où l'appareil est utilisé.

Free Manuals Download Website

<http://myh66.com>

<http://usermanuals.us>

<http://www.somanuals.com>

<http://www.4manuals.cc>

<http://www.manual-lib.com>

<http://www.404manual.com>

<http://www.luxmanual.com>

<http://aubethermostatmanual.com>

Golf course search by state

<http://golfingnear.com>

Email search by domain

<http://emailbydomain.com>

Auto manuals search

<http://auto.somanuals.com>

TV manuals search

<http://tv.somanuals.com>