

azur

840E

 **Cambridge Audio**

Your music + our passion

Important safety instructions

For your own safety please read the following important safety instructions carefully before attempting to connect this unit to the mains power supply. They will also enable you to get the best performance and prolong the life of the unit:

1. Read these instructions.
2. Keep these instructions.
3. Heed all warnings.
4. Follow all instructions.
5. Do not use this apparatus near water.
6. Clean only with a dry cloth.
7. Do not block any ventilation openings. Install in accordance with the manufacturer's instructions.
8. Do not install near any heat sources such as radiators, heat registers, stoves, or other apparatus (including amplifiers) that produce heat.
9. Do not defeat the safety purpose of the polarized or grounding-type plug. A polarized plug has two blades with one wider than the other. A grounding type plug has two blades and a third grounding prong. The wide blade or the third prong are provided for your safety. If the provided plug does not fit into your outlet, consult an electrician for replacement of the obsolete outlet.
10. Protect the power cord from being walked on or pinched, particularly at plugs, convenience receptacles, and the point where they exit from the apparatus.
11. Only use attachments/accessories specified by the manufacturer.
12. Use only with the cart, stand, tripod, bracket, or table specified by the manufacturer, or sold with the apparatus. When a cart is used, use caution when moving the cart/apparatus combination to avoid injury from tip-over. 
13. Unplug this apparatus during lightning storms or when unused for long periods of time.
14. Refer all servicing to qualified service personnel. Servicing is required when the apparatus has been damaged in any way, such as the power-supply cord or plug being damaged, liquid has been spilled or objects have fallen into the apparatus, the apparatus has been exposed to rain or moisture, does not operate normally, or has been dropped.

WARNING - To reduce the risk of fire or electric shock, do not expose this unit to rain or moisture.

The unit is of Class 1 construction and must be connected to a mains socket outlet with a protective earthing connection.

The unit must be installed in a manner that makes disconnection of the mains plug from the mains socket outlet (or appliance connector from the rear of the unit) possible. Where the mains plug is used as the disconnect device, the disconnect device shall remain readily operable. Only use the mains cord supplied with this unit.

Please ensure there is ample ventilation (at least 10cm clearance all round). Do not put any objects on top of this unit. Do not situate it on a rug or other soft surface and do not obstruct any air inlets or outlet grilles. Do not cover the ventilation grilles with items such as newspapers, table-cloths, curtains etc.

This unit must not be used near water or exposed to dripping or splashing water or other liquids. No objects filled with liquid, such as vases, shall be placed on the unit.



The lightning flash with the arrowhead symbol within an equilateral triangle is intended to alert the user to the presence of un-insulated 'dangerous voltage' within the product's enclosure that may be of sufficient magnitude to constitute a risk of electric shock to persons.

The exclamation point within an equilateral triangle is intended to alert the user to the presence of important operating and maintenance instructions in the service literature relevant to this appliance.

WEEE symbol



The crossed-out wheeled bin is the European Union symbol for indicating separate collection for electrical and electronic equipment. This product contains electrical and electronic equipment which should be reused, recycled or recovered and should not be disposed of with unsorted regular waste. Please return the unit or contact the authorised dealer from whom you purchased this product for more information.

CE mark



This product complies with European Low Voltage (2006/95/EC) and Electromagnetic Compatibility (89/336/EEC) Directives when used and installed according to this instruction manual. For continued compliance only Cambridge Audio accessories should be used with this product and servicing must be referred to qualified service personnel.



C-Tick mark

This product meets the Australian Communications Authority's Radio communications and EMC requirements.



Ross Test Stamp

This product meets Russian electronic safety approvals.

FCC regulations

NOTE: THE MANUFACTURER IS NOT RESPONSIBLE FOR ANY RADIO OR TV INTERFERENCE CAUSED BY UNAUTHORIZED MODIFICATIONS TO THIS EQUIPMENT. SUCH MODIFICATIONS COULD VOID THE USER AUTHORITY TO OPERATE THE EQUIPMENT.



This equipment has been tested and found to comply with the limits for a Class B digital device, pursuant to Part 15 of the FCC Rules. These limits are designed to provide reasonable protection against harmful interference in a residential installation. This equipment generates, uses and can radiate radio frequency energy and, if not installed and used in accordance with the instructions, may cause harmful interference to radio communications. However, there is no guarantee that interference will not occur in a particular installation.

If this equipment does cause harmful interference to radio or television reception, which can be determined by turning the equipment off and on, the user is encouraged to try to correct the interference by one or more of the following measures:

- Re-orient or relocate the receiving antenna.
- Increase the separation between the equipment and receiver.
- Connect the equipment into an outlet on a circuit different from that to which the receiver is connected.
- Consult the dealer or an experienced radio/TV technician for help.

Ventilation

IMPORTANT - The unit will become hot when in use. Do not stack multiple units on top of each other. Do not place in an enclosed area such as a bookcase or in a cabinet without sufficient ventilation.

Ensure that small objects do not fall through any ventilation grille. If this happens, switch off immediately, disconnect from the mains supply and contact your dealer for advice.

Positioning

Choose the installation location carefully. Avoid placing it in direct sunlight or close to a source of heat. No naked flame sources, such as lighted candles, should be placed on the unit. Also avoid locations subject to vibration and excessive dust, cold or moisture. The unit can be used in a moderate climate.

This unit must be installed on a sturdy, level surface. Do not place in a sealed area such as a bookcase or in a cabinet. Any space open at the back (such as a dedicated equipment rack) is fine however. Do not place the unit on an unstable surface or shelf. The unit may fall, causing serious injury to a child or adult as well as serious damage to the product. Do not place other equipment on top of the unit.

Due to stray magnetic fields turntables or CRT TVs should not be located nearby due to possible interference.

Electronic audio components have a running in period of around a week (if used several hours per day). This will allow the new components to settle down, the sonic properties will improve over this time.

Power sources

The unit should be operated only from the type of power source indicated on the marking label. If you are not sure of the type of power supply to your home, consult your product dealer or local power company.

This unit has been designed to be left in Standby mode when not in use, this will increase the life of the amplifier (this is true with all electronic equipment). To turn the unit off completely switch off on the rear panel. If you do not intend to use this unit for a long period of time, unplug it from the mains socket.

Overloading

Do not overload wall outlets or extension cord as this can result in a risk of fire or electric shock. Overloaded AC outlets, extension cords, frayed power cords, damaged or cracked wire insulation, and broken plugs are dangerous. They may result in a shock or fire hazard.

Be sure to insert each power cord securely. To prevent hum and noise, do not bundle the interconnect leads with the power cord or speaker leads.

Cleaning

To clean the unit, wipe its case with a dry, lint-free cloth. Do not use any cleaning fluids containing alcohol, ammonia or abrasives. Do not spray an aerosol at or near the unit.

Battery disposal

Please dispose of any discharged batteries according to local environmental/electronic waste disposal guidelines.

Loudspeakers

Before making any connections to loudspeakers, make sure all power is turned off and only use suitable interconnects.

Servicing

These units are not user serviceable, never attempt to repair, disassemble or reconstruct the unit if there seems to be a problem. A serious electric shock could result if this precautionary measure is ignored. In the event of a problem or failure, please contact your dealer.

Limited warranty

Cambridge Audio warrants this product to be free from defects in materials and workmanship (subject to the terms set forth below). Cambridge Audio will repair or replace (at Cambridge Audio's option) this product or any defective parts in this product. Warranty periods may vary from country to country. If in doubt consult your dealer and ensure that you retain proof of purchase.

To obtain warranty service, please contact the Cambridge Audio authorised dealer from which you purchased this product. If your dealer is not equipped to perform the repair of your Cambridge Audio product, it can be returned by your dealer to Cambridge Audio or an authorised Cambridge Audio service agent. You will need to ship this product in either its original packaging or packaging affording an equal degree of protection.

Proof of purchase in the form of a bill of sale or receipted invoice, which is evidence that this product is within the warranty period, must be presented to obtain warranty service.

This Warranty is invalid if (a) the factory-applied serial number has been altered or removed from this product or (b) this product was not purchased from a Cambridge Audio authorised dealer. You may call Cambridge Audio or your local country Cambridge Audio distributor to confirm that you have an unaltered serial number and/or you purchased from a Cambridge Audio authorised dealer.

This Warranty does not cover cosmetic damage or damage due to acts of God, accident, misuse, abuse, negligence, commercial use, or modification of, or to any part of, the product. This Warranty does not cover damage due to improper operation, maintenance or installation, or attempted repair by anyone other than Cambridge Audio or a Cambridge Audio dealer, or authorised service agent which is authorised to do Cambridge Audio warranty work. Any unauthorised repairs will void this Warranty. This Warranty does not cover products sold AS IS or WITH ALL FAULTS.

REPAIRS OR REPLACEMENTS AS PROVIDED UNDER THIS WARRANTY ARE THE EXCLUSIVE REMEDY OF THE CONSUMER. CAMBRIDGE AUDIO SHALL NOT BE LIABLE FOR ANY INCIDENTAL OR CONSEQUENTIAL DAMAGES FOR BREACH OF ANY EXPRESS OR IMPLIED WARRANTY IN THIS PRODUCT. EXCEPT TO THE EXTENT PROHIBITED BY LAW, THIS WARRANTY IS EXCLUSIVE AND IN LIEU OF ALL OTHER EXPRESS AND IMPLIED WARRANTIES WHATSOEVER INCLUDING, BUT NOT LIMITED TO, THE WARRANTY OF MERCHANTABILITY AND FITNESS FOR A PRACTICAL PURPOSE.

Some countries and US states do not allow the exclusion or limitation of incidental or consequential damages or implied warranties so the above exclusions may not apply to you. This Warranty gives you specific legal rights, and you may have other statutory rights, which vary from state to state or country to country.

For any service, in or out of warranty, please contact your dealer.

Plug Fitting Instructions (UK Only)

The cord supplied with this appliance is factory fitted with a UK mains plug fitted with a 5 amp fuse inside. If it is necessary to change the fuse, it is important that a 5 amp one is used. If the plug needs to be changed because it is not suitable for your socket, or becomes damaged, it should be cut off and an appropriate plug fitted following the wiring instructions below. The plug must then be disposed of safely, as insertion into a mains socket is likely to cause an electrical hazard. Should it be necessary to fit a 3-pin BS mains plug to the power cord the wires should be fitted as shown in this diagram. The colours of the wires in the mains lead of this appliance may not correspond with the coloured markings identifying the terminals in your plug. Connect them as follows:

The wire which is coloured BLUE must be connected to the terminal which is marked with the letter 'N' or coloured BLACK.

The wire which is coloured BROWN must be connected to the terminal which is marked with the letter 'L' or coloured RED.

The wire which is coloured GREEN/YELLOW must be connected to the terminal which is marked with the letter 'E' or coloured GREEN.

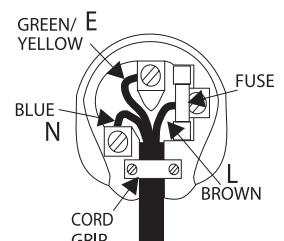

If a standard 13 amp (BS 1363) plug is used, a 5 amp fuse must be fitted, or if any other type of plug is used a 5 amp fuse must be fitted, either in the plug or adaptor, or on the distribution board.

Contents

Important safety instructions	2
Limited warranty.....	3
Contents.....	4
Introduction	4
Rear panel connections.....	5
Front panel controls.....	6
Remote control.....	7
iPod compatibility.....	7
Input connections	8
Power syncing.....	8
Output connections.....	9
Mono Bridged connections	10
Operating instructions	11
Pre-Amplifier setup	11
Multi-Room connections.....	14
Custom installation use.....	15
Technical Specifications.....	15
Troubleshooting.....	15

Make sure you register your purchase.

Visit: www.cambridgeaudio.com/sts

By registering, you'll be the first to know about:

- Future product releases
- Software upgrades
- News, events and exclusive offers plus competitions!

This guide is designed to make installing and using this product as easy as possible. Information in this document has been carefully checked for accuracy at the time of printing; however, Cambridge Audio's policy is one of continuous improvement, therefore design and specifications are subject to change without prior notice.

This document contains proprietary information protected by copyright. All rights are reserved. No part of this manual may be reproduced by any mechanical, electronic or other means, in any form, without prior written permission of the manufacturer. All trademarks and registered trademarks are the property of their respective owners.

Incognito, Incognito Ready and TerraPin are trademarks of Cambridge Audio Ltd. All rights reserved.

Class XD Technology International Patent Pending Cambridge Audio Ltd.

© Copyright Cambridge Audio Ltd 2008

A-BUS and A-BUS Ready are registered trademarks of LeisureTech Electronics Pty Ltd Australia. This product may be covered by one or more of the following patents: US 7,181,023, 6,389,139, EP 1004222, AU 739808, NZ 502982, Mexico Z41196, Canada CA2301062.

iPod and Apple are trademarks of Apple Inc., registered in the U.S. and other countries.

Introduction

Thank you for purchasing this Azur 840E Pre-Amplifier. We hope that you will enjoy many years of listening pleasure from it.

Cambridge Audio has taken the Azur 840 series to its peak with the introduction of two new models – the 840E Pre-Amplifier and 840W Power Amplifier. The 840E is a high-end pre-amplifier which uses Cambridge Audio's new proprietary TerraPin™ modules for unprecedented audio fidelity, forming the perfect partner for the accompanying 840W power amplifier.

Other features include the use of precision resistor ladders switched by gold plated relay contacts for the volume and balance controls rather than the more common solid-state or volume potentiometer schemes. Volume is controllable in 1 dB steps over most of the range, giving very fine control, an accurate logarithmic law and superbly accurate channel balance. Input switching is also by high quality gold contact relays.

Inputs 1 and 2 feature balanced inputs using XLRs giving optimal performance with equipment such as the matching 840C Upsampling CD player which feature balanced outputs.

The casework combines massive structural rigidity with careful damping and control of acoustic resonance. An Azur Navigator remote control is also provided, giving full remote control in an attractive and easy to use handset.

We have also included support for multi-room use. By plugging in one or two external Cambridge Audio Incognito keypads and a power supply unit, this unit can become the hub of a simple multi-room system. In addition, Control Bus Input/Output, IR Emitter Input, Trigger In/Out and RS232 control are featured making it easy to integrate the 840E into a Custom Installation system if desired.

Your pre-amplifier can only be as good as the system it is connected to. Please do not compromise on your source equipment, power amplifier or cabling. Naturally we particularly recommend models from the Cambridge Audio Azur range, in particular the matching 840W Class XD™ Power Amplifier. These have been designed to the same exacting standards as this pre-amplifier. Your dealer can also supply excellent quality Cambridge Audio interconnects to ensure your system realises its full potential.

Thank you for taking the time to read this manual; we do recommend you keep it for future reference.

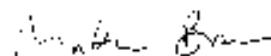

Matthew Bramble,
Cambridge Audio Technical Director
and the 840E/840W design team

Rear panel connections

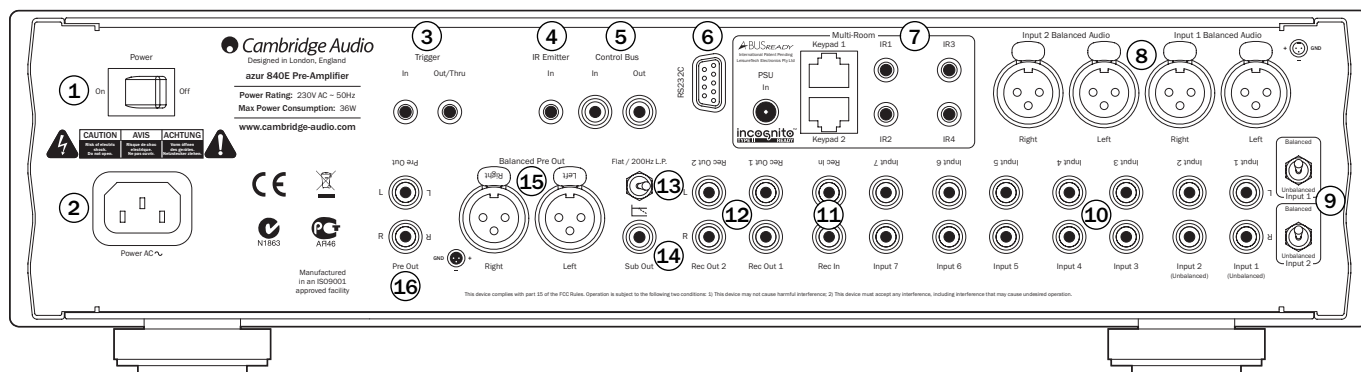

① Power On/Off

Switches the unit on and off.

② AC power socket

Once you have completed all connections to the unit, plug the AC power cable into an appropriate mains socket then switch on. Your unit is now ready for use.

③ Trigger In, Out/Thru

For Custom Install use, the 840E can be turned on and off (i.e. brought in and out of Standby mode) by the presence of 5-12V DC at the Trigger input. A trigger input will also produce an internally generated 12V DC trigger output at the Output/Thru connection. Turning the 840E on from the remote/front panel also produces a 12V DC trigger output at the Output/Thru connection. This can be used to turn on/Standby a connected 840W power amplifier if desired. Refer to the 'Power syncing' section of this manual for more information.

④ IR (Infra-Red) Emitter In

Allows modulated IR commands from multi-room systems or IR repeater systems to be received by the unit. Commands received here are not looped out of the Control Bus. Refer to the 'Custom installation' section of this manual for more information.

⑤ Control Bus

In - Allows un-modulated commands from multi-room systems or other components to be received by the unit.

Out - Loop out for Control Bus commands to another unit.

Also allows the 840E to turn on/off some Cambridge Audio units, including the matching 840W power amplifier. Refer to the 'Power syncing' section of this manual for more information.

⑥ RS232C

The RS232C port allows external serial control of the 840E for custom install use. A full command set is available on the Cambridge Audio website at www.cambridge-audio.com. This port can also be used by Cambridge Audio service personnel for software updates.

⑦ A-BUS™ Ready / Incognito Ready™ multi-room outputs

PSU In - Connect an Incognito PS5 to supply power to the connected multi-room keypads/speakers.

Keypad 1/2 - Connect one or two Incognito A-BUS KP10 keypads (or other A-BUS compatible keypads) using CAT5/5e cable. Incognito AS10 Active Ceiling Speakers can also be connected here.

IR - Four IR outputs for remote control of source equipment.

Please refer to the 'Multi-Room' section of this manual for more information on connections and set-ups.

⑧ Input 1/2 Balanced Audio

Inputs 1 and 2 feature either unbalanced (phono/RCA) or balanced (XLR) connections. Either type may be used but not both at the same time. The balanced connection is the higher quality option and can reject noise and interference in the cable when used with other equipment that supports this function. An XLR connector is wired Pin 1 - Ground; Pin 2 - Hot (in-phase); Pin 3 - Cold (phase-inverted).

Use the Balanced/Unbalanced switch (Item 9) to select the connection type you wish to use. The unused input does not require to be terminated.

⑨ Input 1/ Input 2 Balanced/Unbalanced switch

Use to select the connection type for Input 1/ Input 2.

⑩ Inputs 1-7

These inputs are suitable for any 'line level' source equipment such as CD players, DAB or FM/AM tuners etc.

Note: These inputs are for analog audio signals only. They should not be connected to the digital output of a CD player or any other digital device.

⑪ Rec In (Input 8)

Connect to the output sockets of a Tape/MD player or other devices that support recording.

⑫ Rec Out 1/2

Connect to the input sockets of your recording device.

⑬ Flat/200Hz LP switch

The 840E features a Sub output that is a separate mono mix created from the main pre-amp outputs. This output can have either a 'Flat' (i.e. full range, unfiltered) frequency response or a 200Hz Low Pass filter can be applied. Most Subwoofers feature built in Low Pass filtering and 'Flat' is usually the best setting. This setting does not affect the main outputs which are always full-range.

⑭ Sub Out

Connect to the input on an active subwoofer if required.

⑮ Balanced Pre Out

For connection to the balanced inputs of a power amplifier that support this type of connection.

⑯ Pre Out

For connection to the unbalanced inputs of a power amplifier.

Front panel controls

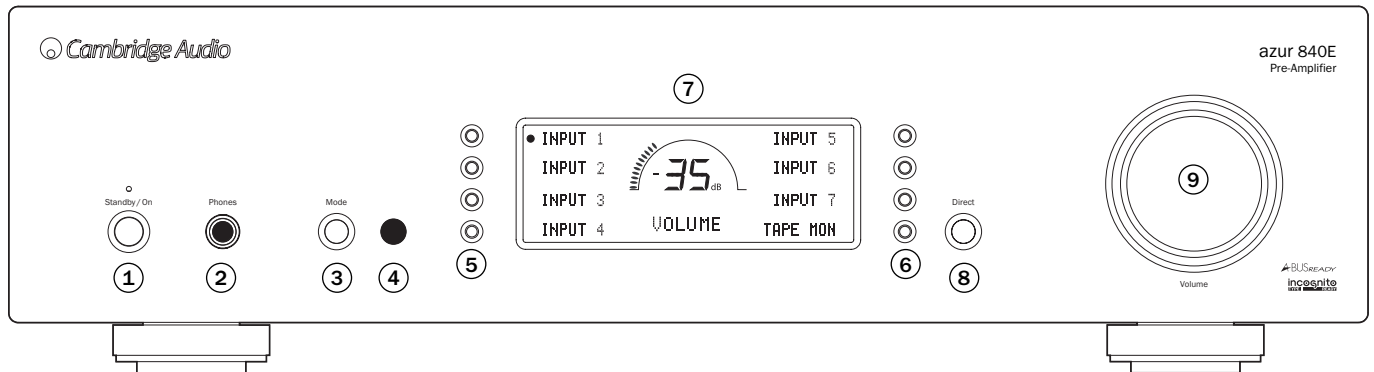

① Standby/On

Switches the unit between Standby mode (indicated by dim power LED) and On (indicated by bright power LED). Standby is a low power mode where the power consumption is less than 30 Watts. The unit can be left in Standby mode when not in use. If the unit is not going to be used for a long period of time it should be switched off via the Power On/Off switch on the rear panel.

Note: As default the 840E ramps the volume up or down when switched on and when going into Standby mode. This feature can be turned off if desired; please refer to the 'Pre-amplifier setup' section of this manual for more information.

② Phones

Allows for the connection of stereo headphones with a ¼" Jack plug. Headphones with an impedance of between 32 and 600 ohms are recommended. When the headphones are connected, the loudspeaker relays are released switching off the output to the loudspeakers (speakers A and B).

③ Mode

Press to switch between Volume, Balance, Bass and Treble modes. Press and hold to enter the 840E System Configure menu.

④ Infrared sensor

Receives IR commands from the supplied Azur remote control. A clear unobstructed line of sight between the remote control and the sensor is required.

⑤ & ⑥ Input select buttons

Push the appropriate input selection button to select the source component that you wish to listen to (highlighted by a solid circle on the display). The signal selected is also fed to the Rec Out sockets so that it may be recorded. The input should not be changed whilst recording.

⑦ Display

LCD used to control the 840E. Please refer to the 'Operating instructions' and 'Pre-amplifier setup' section of this manual for more information.

⑧ Direct

This control gives the audio signal a more direct path by bypassing the tone control circuits for the purest possible sound quality.

The Bass/Treble icon (B : f) appears in the display when the bass and treble circuit is active (in circuit) and is not present when they are bypassed.

Note: Direct can be set on or off individually for each input. This setting is recalled each time a source is selected.

⑨ Volume

Use to increase/decrease the level of the sound from the outputs of the amplifier. This control affects the level of the loudspeaker output, the pre-amp output and the headphone output. It does not affect the Tape Out connections.

As the 840E uses a very high quality passive resistor ladder switched by relays to achieve volume and balance, audible control clicks can be heard from the unit when the volume or balance is adjusted.

The Volume control is also used in navigating the 840E System Configure menus on the front panel display.

Please refer to the 'Operating instructions' section of this manual for more information on some functions of these buttons.

Remote control

The 840E is supplied with an Azur Navigator remote control that operates both this amplifier and Cambridge Audio Azur CD players. Insert the supplied AAA batteries to activate.

The functions relevant to the amplifier are as follows:

Standby/On

Switches the amplifier between On and Standby mode.

Numerical buttons 1-8

Press to change the input source to the amplifier. Button 8 toggles Tape Monitor on/off.

Bright

Adjust the backlight of the front panel display; bright, dim or off.

Mode

Press to switch between Volume and Balance modes.

Mute

Mutes the audio on the amplifier. The mute mode is indicated by MUTE appearing and the volume level being replaced by two flashing dashes in the display. Press again to cancel mute.

Volume

Increase or decrease the volume of the amplifier output.

The following functions can be optionally used to control Cambridge Azur range CD players:

Open/Close

Opens and closes the disc tray.

Play / Stop / Pause

Press the relevant button to play, stop or pause the CD.

Skip

Right Skip - Press once to skip forward by one track on the CD. Press and hold to skip forwards through tracks.

Left Skip - Press once to skip backward by one track on the CD. Press and hold to skip backwards through tracks.

Search

Press and hold to search within the selected track. Right button to fast forward, left button to rewind.

Repeat, Random, Remain

Refer to the 'Operating instructions' section of your CD player manual for information on the functions of these buttons.

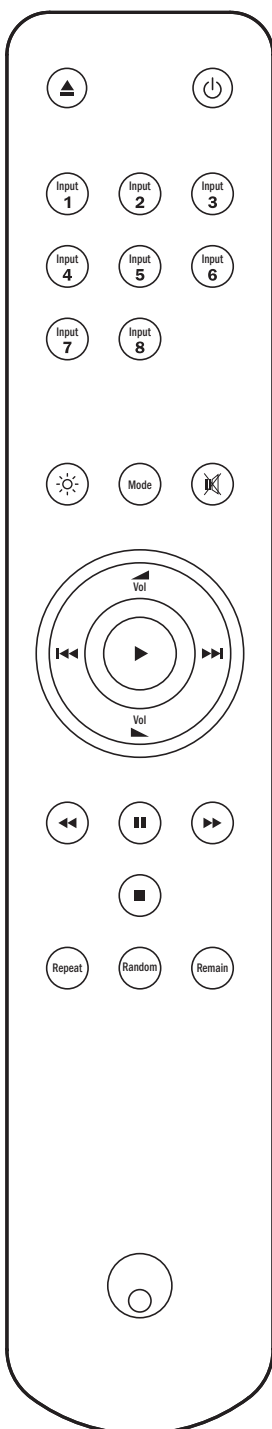

iPod compatibility

To make use of the iPod functionality, your iPod dock must be connected to 'Input 4'.

The 840E remote can also control the basic functions of Apple iPod models when mounted in Cambridge Audio's iPod docks, Apple's Universal Dock or other docks compatible with the Apple Remote. Refer to your dock's instruction manual on how to make connections.

To use the Azur remote to control the docked iPod, hold down the *Input 4* button whilst pressing one of the following buttons:

Play/Pause

Press to play the iPod, press again to pause play.

Skip

Press once to skip forwards or backwards one track.

Input (Source) connections

Inputs 1 and 2 on the 840E feature either unbalanced (phono/RCA) or balanced (XLR) connections. The 840E is designed to work at its highest performance when a balanced interconnect is used.

The diagrams below shows the 840E pre-amplifier connected to an Azur 840C CD player in unbalanced (Figure 1) and balanced (Figure 2) configurations. The 840E can also be connected to non Cambridge Audio sources with balanced outputs.

Balanced connections in an audio system are designed to reject electrical noise, from power wiring etc, and also the effects of noise currents flowing through ground connections. The basic principle of balanced interconnection is to get the signal you want by subtraction,

using a three-wire connection. One signal wire (the hot or in-phase) carries the normal signal, while other (the cold or phase-inverted) carries an inverted version. The balanced input senses the difference between the two lines to give the wanted signal. Any noise voltages that appear identically on both lines (these are called common-mode signals) are cancelled by the subtraction.

Make sure the Balanced/Unbalanced switch for Inputs 1 and 2 are set to the connection type you wish to use.

Figure 1: Unbalanced input

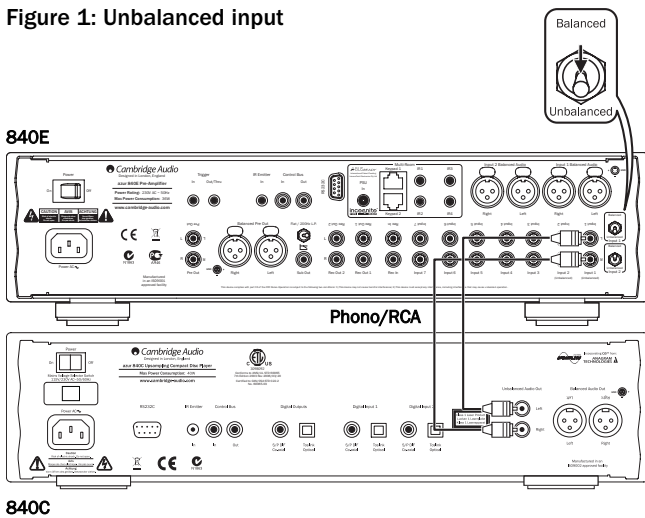
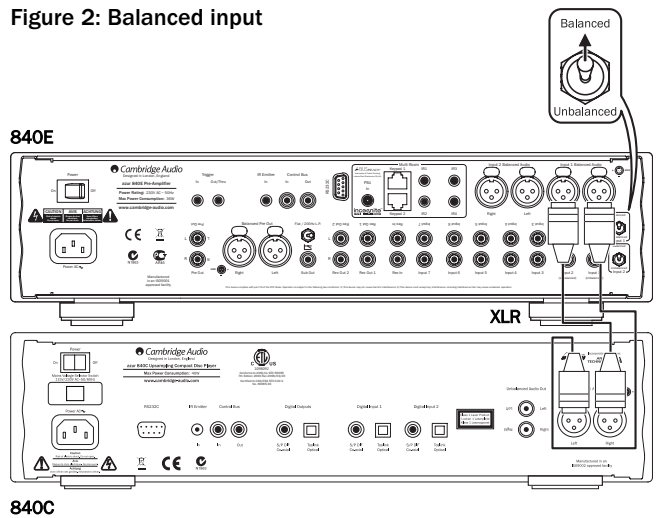

Figure 2: Balanced input



Power syncing (On/Standby control)

When going in/out of Standby mode the Azur 840E pre-amplifier can (if desired) automatically control the 840W when connected via the Control Bus sockets (the Control Bus sockets are colour-coded orange on the rear panels of compatible Azur models). For this feature to work the units must be connected together by RCA/phono leads. No further setup is necessary.

Connect the Control Bus Out from the 840E to the Control Bus In on the 840W. Continue the chain to other Azur models if it is required to sync more units (refer to the 840E's own manual for more information as this requires some setup).

Note: The 840E features a Trigger Out which can alternatively be used to control the 840W's Standby/On status if desired. Again, the procedure is simply to connect the two units together (using a 3.5mm mono mini-jack lead in this case).

Control Bus is the recommended method when using an 840E and other Cambridge Audio equipment with Control Bus In/Out.

Trigger In/Out can be useful if the 840W (and indeed 840E) is desired to be controlled by other equipment that features trigger outputs (Custom install and/or Multi-Room Systems etc).

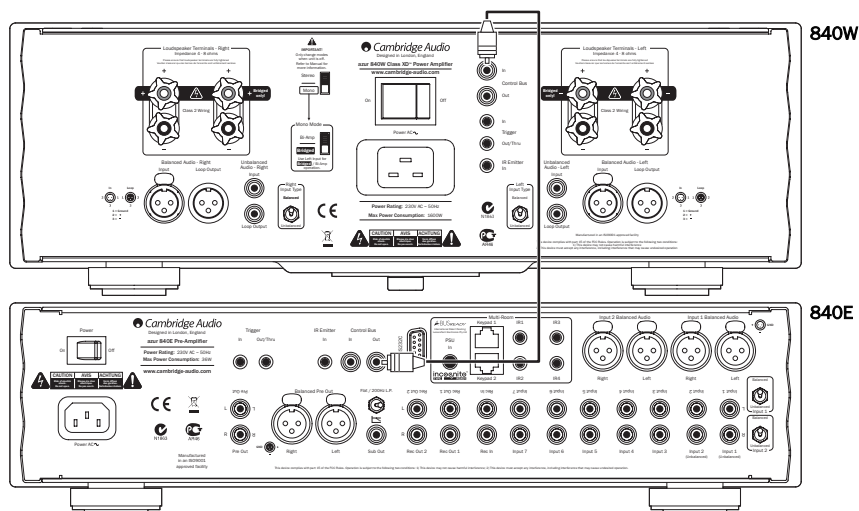

Output connections - Unbalanced

The 840E features both balanced (XLR) and unbalanced (RCA/Phono) output connections. For the best quality we recommend you use the balanced output with power amplifiers that feature this connection (such as our own 840W Class XD power amplifier).

The diagram below shows the 840E pre-amplifier connected to an Azur 840W power amplifier and a pair of loudspeakers.

When using unbalanced (phono/RCA) connections, the Left and Right Input Type switches on the 840W must be in the 'Unbalanced' position.

Before making any connections to the loudspeakers, make sure all power is turned off and only use suitable interconnects (e.g. banana plugs). Ensure that the positive (+) and negative (-) connections are matched.

Your loudspeaker may have more than one pair of connecting terminals; LF (Low Frequency) and HF (High Frequency). For single-wiring it is recommended to connect to the LF terminals. The metal strip connecting the low-frequency terminals to the high-frequency terminals must **not** be removed (only to be removed for a bi-wiring system).

Note: In this configuration the 840W must be set to Stereo mode.

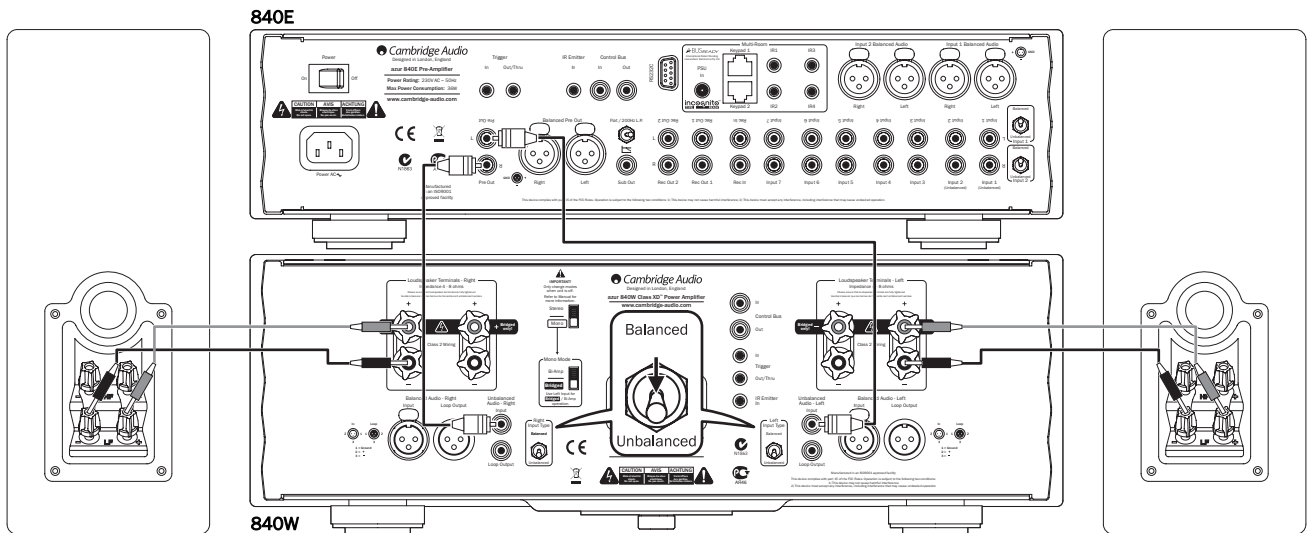

Output connections - Balanced

The diagram below shows the 840E connected to an 840W using the Balanced Audio inputs via three-pin XLR connectors.

When using balanced (XLR) connections, the Left and Right Input Type switches on the 840W must be in the 'Balanced' position.

Before making any connections to the loudspeakers, make sure all power is turned off and only use suitable interconnects (e.g. banana plugs). Ensure that the positive (+) and negative (-) connections are matched.

Your loudspeaker may have more than one pair of connecting terminals; LF (Low Frequency) and HF (High Frequency). For single-wiring it is recommended to connect to the LF terminals. The metal strip connecting the low-frequency terminals to the high-frequency terminals must **not** be removed (only to be removed for a bi-wiring system).

Note: In this configuration the 840W must be set to Stereo mode.

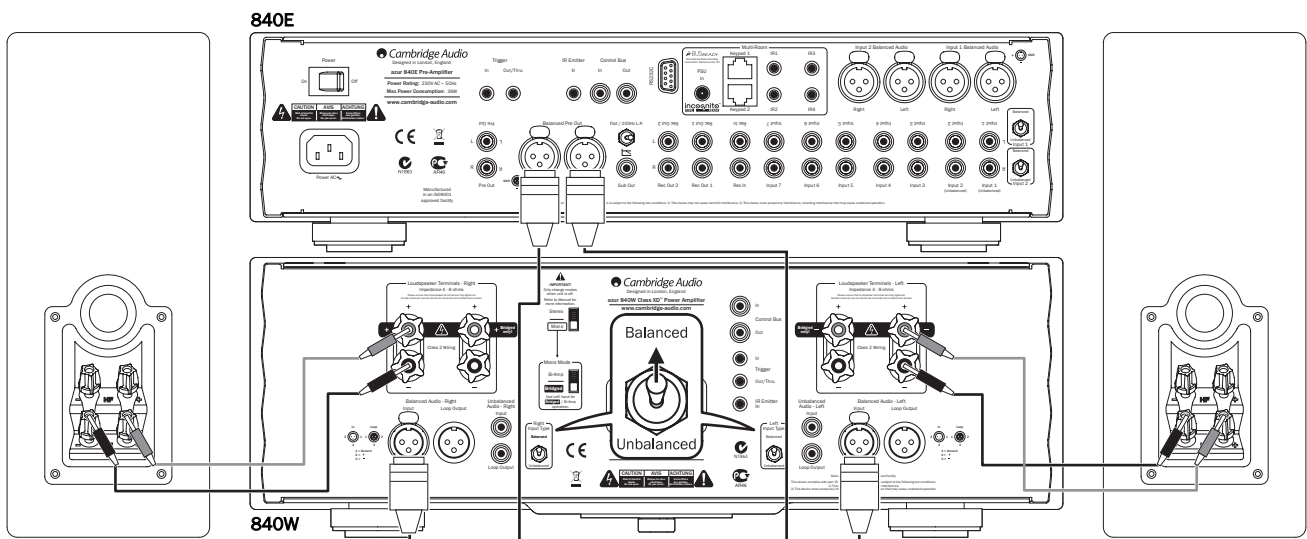

Mono Bridged connections

The matching Azur 840W power amplifier features Mono and Bridged Mono settings that allow two (or more) 840Ws to be used as mono-blocs for high end systems. Below is an example using two 840Ws in Bridged Mono with an 840E.

In Bridged Mono mode each 840W drives one speaker across its output channels acting as a 500W mono amplifier instead of a 200wpc stereo one. One 840W drives the left speaker and the other the right. See the 840W manual for full details on Bridged Mono and other possible combinations.

The example below uses balanced connections from 840E to each 840W, unbalanced connections can also be used and the principle is the same.

Important! 840W settings

Before making any connections to the loudspeakers, make sure all power is turned off and only use suitable interconnects (e.g. banana plugs). Ensure that the positive (+) and negative (-) connections are wired as shown in the diagram.

When using balanced (XLR) connections, the Left and Right Input Type switches on the 840W must be in the 'Balanced' position. When using unbalanced (phono/RCA) connections, the Left and Right Input Type switches on the 840W must be in the 'Unbalanced' position.

Only use the Left Inputs on the 840W for Bridged operation.

In this configuration the Stereo/Mono switch on the 840W must be set to 'Mono' and the Mono mode switch must be set to 'Bridged'.

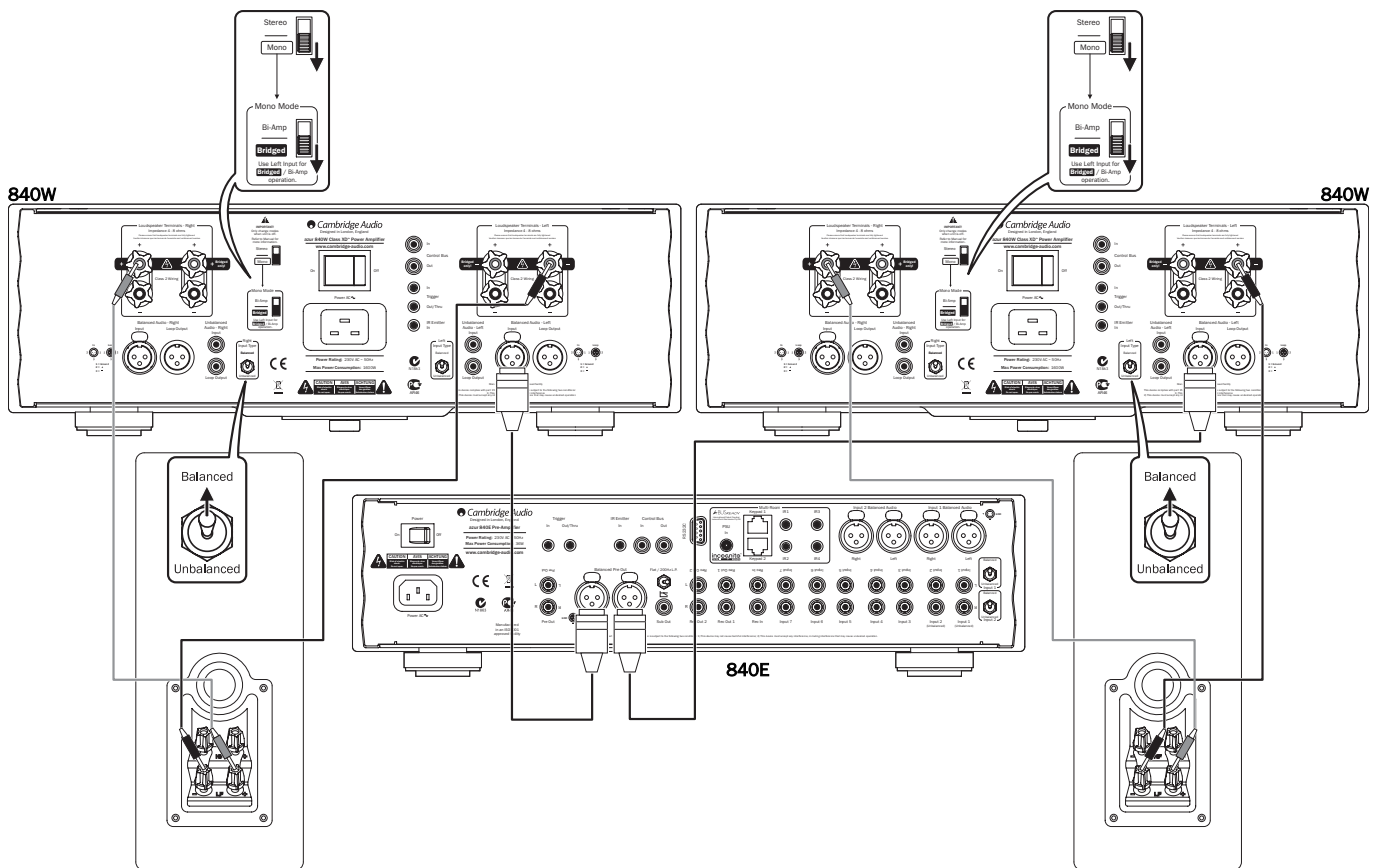

Operating instructions

The 840E has a custom-made display on the front of the unit that shows the current status and allows you to access the 840E System Configuration menus. Here you can adjust the listening settings of the amplifier to personal preference. The menu system is easy to navigate and control, simply by using the input select buttons to turn a feature on (solid circle) or off (no circle) and the volume control knob to increase/decrease settings.

Volume

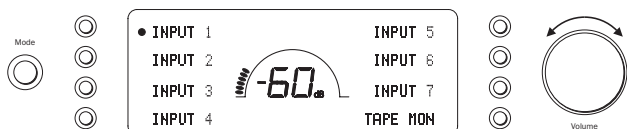

Adjust the volume control knob on the front panel (or using the remote control). The display will show the change in volume in decibels (dB). '0dB' indicates maximum volume while lower volume settings progress into the negative range. This can also be changed to arbitrary volume units (0-96) in the System Configure menu.

Balance, Bass, Treble

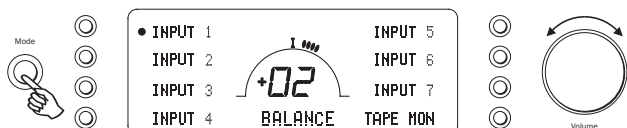

Press the *Mode* button to scroll through the options of Balance, Treble or Bass modes. BALANCE, TREBLE or BASS will appear on the display depending on which mode you have entered. Adjustments can then be made using the volume control. This allows subtle adjustments to the tonal balance of the sound. These modify the sound through your loudspeakers and the Pre-Out sockets only; they do not affect the signals sent through the Tape Out connections.

Press the *Mode* button again to return to Volume mode or wait 5 seconds for the 840E to automatically exit and return to Volume mode.

Direct

With a well produced CD and a good system the tone controls are unnecessary and can be switched out by pressing the *Direct* button:

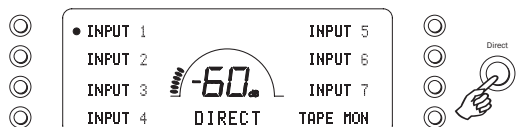

This completely removes them from the signal path for maximum fidelity. If the musical recording is of poor quality or other factors are affecting the sound quality, you can adjust the tone controls to compensate. To use the tone controls press the *Direct* button so that the Bass/Treble icon ($\text{B} \text{ } \text{H}$) lights in the display indicating that they are active and direct mode is Off.

The 840E stores whether Direct mode is on or off **for each input individually**. For example it is possible to have the tone controls automatically active for the Tuner source but not the CD source.

Pre-amplifier setup

The 840E features many advanced settings that allow its use to be customised to user preference. The inputs can be named to reflect the actual source units you have, each input can be trimmed so that each sounds the same in terms of loudness when you switch between them and other options.

Changing input names / source naming



Press and hold the relevant input select button for four seconds to change its name. For example, if Input 1 is a CD player, name it "CD" etc. Letters are selected by turning the volume control to scroll through the available characters. Press LEFT or RIGHT to select which character you wish to edit. Press EXT CHAR to access an extended character set. Press OK to confirm and exit the input name change menu.

System Configure menu

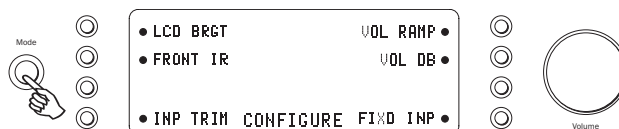

Press and hold the *Mode* button to access the System Configure menu. The menu options are LCD brightness, Front IR, Input gain trim, Volume ramp, Volume display, and Fixed input gain.

To exit the System Configure menu and its sub-menus, press the *Mode* button again.

LCD brightness

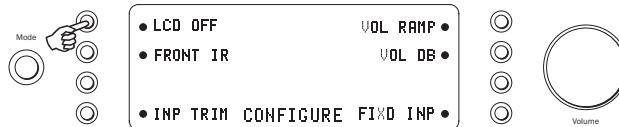

In the System Configure menu press the LCD input select button to scroll through bright/dim/off settings for the front panel display. Press the *Mode* button to exit.

Volume ramp

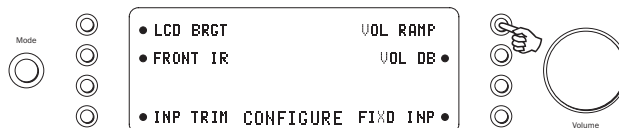

The 840E automatically ramps the volume down when going into Standby mode and up when coming out of Standby mode. To turn this feature off, press the VOL RAMP input select button in the System Configure menu and set to off. Press the *Mode* button to exit.

Volume display

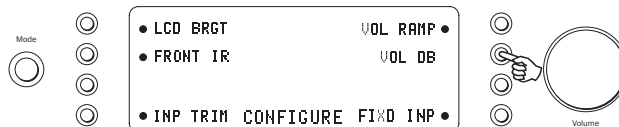

To change the volume display from decibels (-95 to 0dB) to arbitrary volume units (0 to 96 units) select VOL DB in the System Configure menu. Press the input select button to turn off the volume in decibels. Press the *Mode* button to exit.

Pre-amplifier setup continued

Front IR

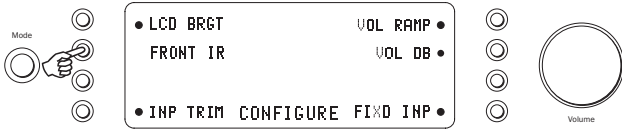

Used in conjunction with Custom Installation (C.I.) systems or IR repeater systems, it may be desirable to disable the front panel IR by setting FRONT IR to off (press the input select button to turn off). Press the *Mode* button to exit.

Input gain trim

The relative levels of the inputs can be adjusted by gain trim. This allows each to be adjusted so that each sounds the same in terms of average loudness when you switch between them. Pick the loudest sounding source and trim its level until it matches the average perceived level of the others. Repeat this process if other sources also stand out as louder than the average.



To set the input gain trim for each source, select INP TRIM in the System Configure menu. Select the input required and use the volume control to set the gain between 0 and -12 dB (the available range is restricted if the volume is set very low). Press the *Mode* button to exit.

Fixed level inputs

Any input of the 840E is able to be set for fixed gain. Whenever this input is selected the gain will automatically go to this value and will not be adjustable by the volume control. This can be useful with sources that have their own built in volume control (such as some set-top boxes etc.)

Also, this feature can be used to integrate an AV Receiver which has pre-amp outputs (such as our own 540R or 640R models) with the 840E.

The front Left and Right pre-amp outputs of the AV Receiver are simply fed to any desired input of the 840E and that input set for fixed gain. The AV receiver is then wired to the various surround speakers whilst the 840E/W drives the Front Left and Right.

The 840E/W can then be used for Stereo sources as normal for best sound quality. When it is desired to decode surround sound, select the input chosen for fixed gain on the 840E. Now the AV Receiver can be used to decode any of its surround sound sources. It will have control of the volume of all channels and the 840E's own volume control will be disabled.

You may wish to re-name the fixed level input as "AV mode" or similar on the 840E. As the gain can be fixed to any value it is easy to match the level of the 840E to that of the other AV channels.

To set a fixed volume for a source, select FIXED INP in the System Configure menu:



Select the input required and set the fixed gain using the volume control (the OFF setting does not disable the input but leaves the input gain subject to the volume control which is the default setting). When a source has a fixed input, the balance is always set to neutral. Press the *Mode* button to exit.

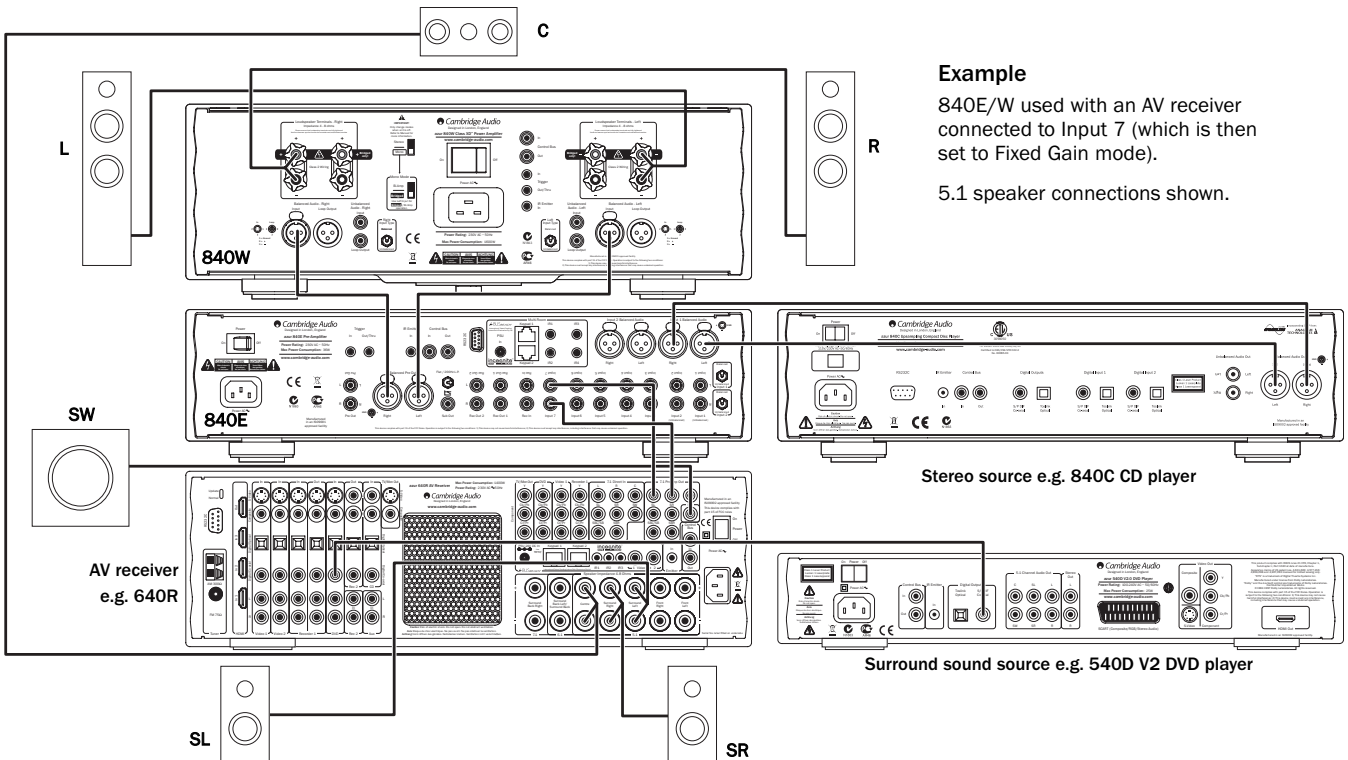

Example
840E/W used with an AV receiver connected to Input 7 (which is then set to Fixed Gain mode).
5.1 speaker connections shown.

On/Off control menu

When going in/out of Standby mode the 840E can automatically turn on and off other connected Cambridge Audio Azur models that have control bus sockets. For this feature to work the units must be connected together (see diagram) by RCA/phono leads. The Control Bus sockets are colour-coded orange on the rear panels of compatible Azur models. Connect the Control Bus Out from the 840E to the Control Bus In on another Azur model (e.g. 840W). Continue the chain to other Azur models if required.

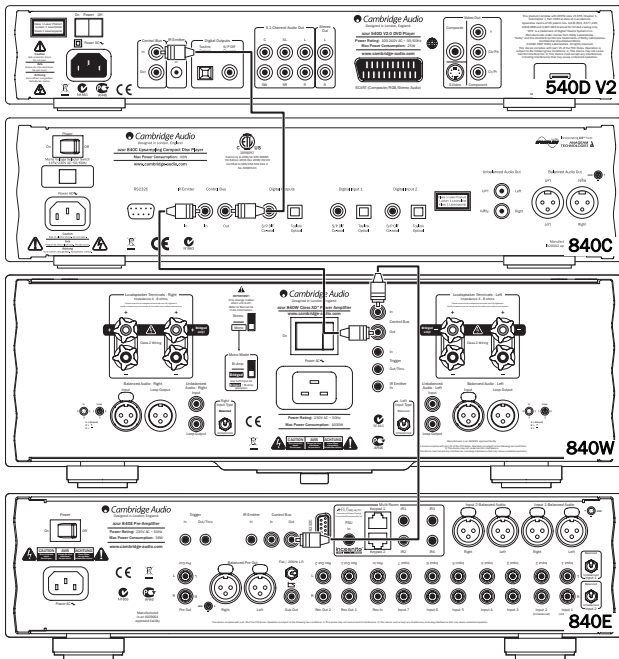

Now while the 840E is on press and hold the *Standby/On* button until ON/OFF CTR appears on the display:

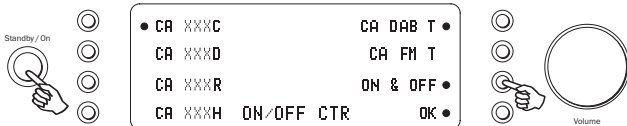

Select the connected Azur models by pressing the appropriate input select button. For example, CA XXXC for an Azur CD player (740C, 840C), CA XXXD for an Azur DVD player, CA DAB T for an Azur DAB tuner etc.

Press ON & OFF to scroll through the options of ON (turns all Azur units on only), OFF (turns all Azur units into Standby only) or ON & OFF (turns all Azur units on and into Standby mode).

Press OK to confirm and exit.

Multi-room connections

The 840E features Incognito Ready/A-BUS Ready outputs, allowing multi-room capability. One or two amplified keypads can be plugged into the 840E (using Cat5/5e cable and RJ45 plugs) to provide multi-room audio in one or two secondary rooms or zones. The keypads are powered by an external PSU (also required) through the Cat5/5e cables and no mains connection is required in the secondary rooms.

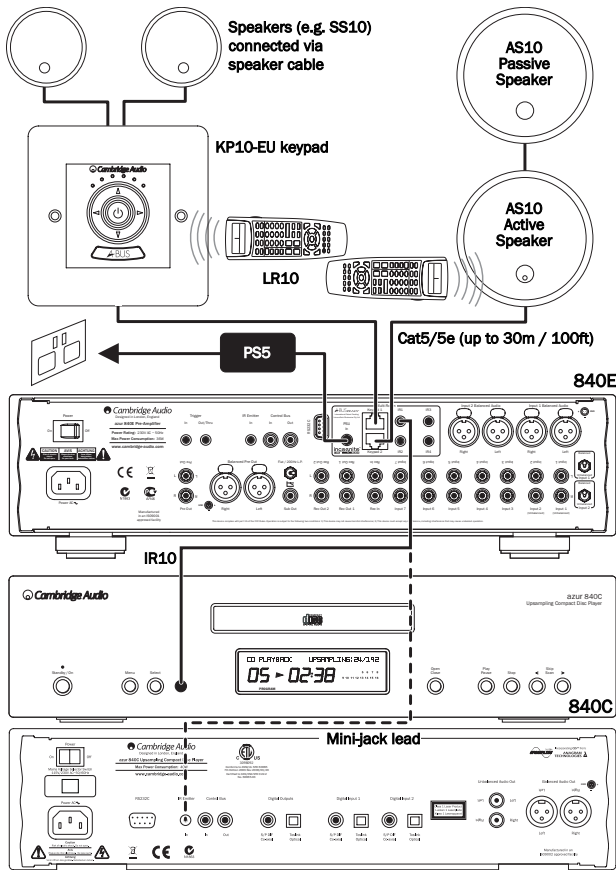
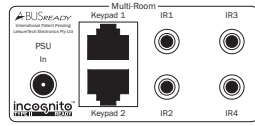

The 840E is Incognito Ready Type II, which means the keypads can operate independently of the amplifier in terms of volume/bass/treble etc, be independently turned on and off, and can also listen to a different source from that which is currently selected on the amplifier. However, both keypads can only listen to the same source.

A-BUS is a standard that allows compatibility between different manufacturers equipment, so A-BUS compatible keypads from other manufacturers can also be used. If used with our own Incognito KP10 keypads, there are some extra features such as the ability to change source on the 840E from the keypad (EU model shown here):

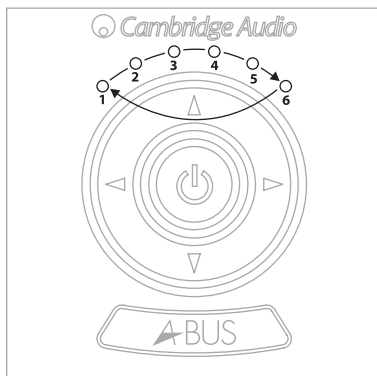

- Order of selection:
1. Input 1
 2. Input 2
 3. Input 3
 4. Input 4
 5. Input 5
 6. Input 6 (Tape)

Connections to the 840E Incognito Ready / A-BUS Ready outputs are made by Cat-5 cable (terminated with an RJ45 jack plug). The RJ45 plug must be wired to the EIA/TIA 568A wiring standard:

- Wire colours:
- | | | |
|----------------|-----------------|----------------|
| 1. Green/White | 3. Orange/White | 6. Orange |
| 2. Green | 4. Blue | 7. Brown/White |
| | 5. Blue/White | 8. Brown |

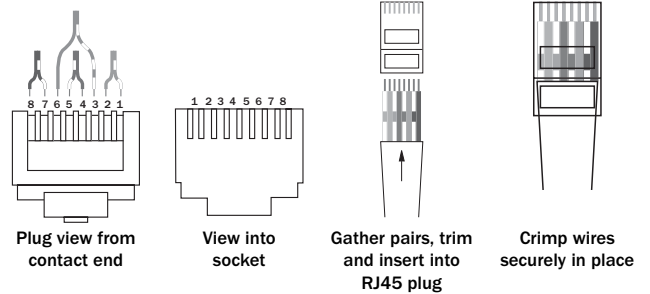

To allow control of your source equipment from the remote rooms an IR emitter (IR10) is plugged into one of the IR outputs on the rear of the unit and then attached over the IR window of the source unit. Alternatively, on our own products that feature IR emitter Inputs, a mini-jack to mini-jack lead can be used. Commands received by the keypads can now be sent back to the source equipment via the 840E.

It is then possible to control the source equipment from the remote rooms by using the source equipment's own remote controls or through a learning remote. The Incognito LR10 Learning Remote can fully control the keypads, "learn" the source's remote control codes (including those from other manufacturers) and change source input on the 840E etc.

On the front panel display of the 840E the extra multi-room zones are indicated by a circle outline next to the input source (see Fig. 1). When listening to the same source, the circle outline and solid circle overlap (see Fig. 2).

Fig. 1 - One or both keypads are listening to a different source (Input 2) to the amplifier (Input 1).

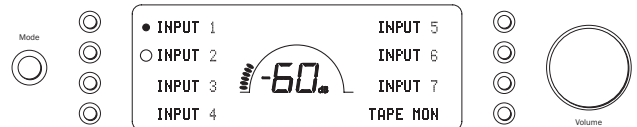
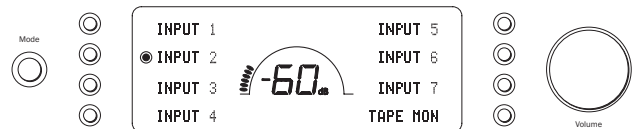

Fig. 2 - One or both keypads are listening to the same source (Input 2) as the amplifier (Input 2).



For further details on the Incognito multi-room system please contact your local Cambridge Audio dealer or visit: www.cambridge-audio.com

Custom installation (C.I.) use

The 840E features a Control Bus input/output that allow un-modulated remote control commands (positive logic, TTL level) to be received electrically by the unit and looped to another unit if desired. These control commands are typically generated by custom installation (multi-room) systems or remote IR receiver systems. The Control Bus sockets are colour-coded orange.

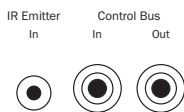

An IR Emitter Input is also provided that allows modulated IR remote control commands to be received electrically by the unit. Commands on this input operate the unit only and are not looped out demodulated on the Control Bus Output.

An RS232C port is also featured which allows the 840E to be controlled by C.I. systems.



In addition the unit features 'direct' IR/Control codes as well as toggle codes for some of their features to simplify programming custom installation systems. Special direct On/Off and Mute commands can be accessed on the supplied remote control for teaching into C.I. systems as follows:

1. Press and hold the *Standby/On* button. The remote first generates it's standby (toggle) command. Keep the button held down, after 12 seconds an amplifier "On" command will be generated. If the button is kept held down for a further 12 seconds, an amplifier player "Off" command is generated.
2. Press and hold the *Mute* button. The remote first generates it's mute (toggle) command. Keep the button held down, after 12 seconds a "Mute on" command will be generated. If the button is kept held down for a further 12 seconds, a "Mute off" command is generated.

A full code table and RS232 protocol for this product is available on the Cambridge Audio website:

www.cambridge-audio.com

Technical specifications

THD (+ noise)	< 0.0006% @1kHz < 0.003% @20kHz
S/N (unweighted)	< 121dB < 100dBu
Frequency response	10Hz - 100kHz ± 0.1dB
Crosstalk @1kHz	> 100dB
Input isolation	> 115dB
Maximum output	8V rms unbalanced 8V + 8V rms balanced
Output impedance	100 Ohms (Unbalanced or Balanced)
Subwoofer out	Flat or 200Hz 2nd Order Butterworth LPF
Max power consumption	36W
Bass & Treble controls	Shelving type Max bass boost/cut ± 10 dB at 10 Hz Max treble boost/cut ± 7.5 dB at 20 kHz
Dimensions (H x W x D)	115 x 430 x 385mm (4.5 x 16.9 x 15.2")
Weight	8.7kg (19.1Lbs)

Troubleshooting

There is no power

- Ensure the AC power cord is connected securely.
- Ensure the plug is fully inserted into the wall socket and is switched on.
- Check fuse in the mains plug or adaptor.

There is no sound

- Make sure the unit is not in Standby mode.
- Check that source component is properly connected.
- Check that Input 8 (Rec In) is not switched on (unless a tape input is required).
- Check that your speakers are properly connected.
- Make sure unit is not in mute mode.

There is no sound on one channel

- Ensure that balance control is in the correct position.
- Check speaker connections.
- Check interconnects.

There is a loud buzz or hum

- Check turntable or tone arm for ground and connection lead fault.
- Ensure no interconnects are loose or defective.
- Ensure that your tape deck/turntable is not too close to the unit.

Unable to make or play tape recordings

- Check that Input 8 (Rec In) and Rec Out have been connected correctly.

There is weak bass or diffused stereo imaging

- Ensure that speakers are not wired out of phase.

The remote handset will not function

- Check that the batteries have not expired.
- Ensure that nothing is blocking the remote sensor.

For more frequently asked questions (FAQs), technical advice and information on getting the most out of your 840E, please visit the Support section on Cambridge Audio's website: www.cambridgeaudio.com/support.php

For all servicing, in or out of warranty, please contact your dealer.

Cambridge Audio is a brand of Audio Partnership Plc
Registered Office: Gallery Court, Hankey Place
London SE1 4BB, United Kingdom
Registered in England No. 2953313

www.cambridge-audio.com

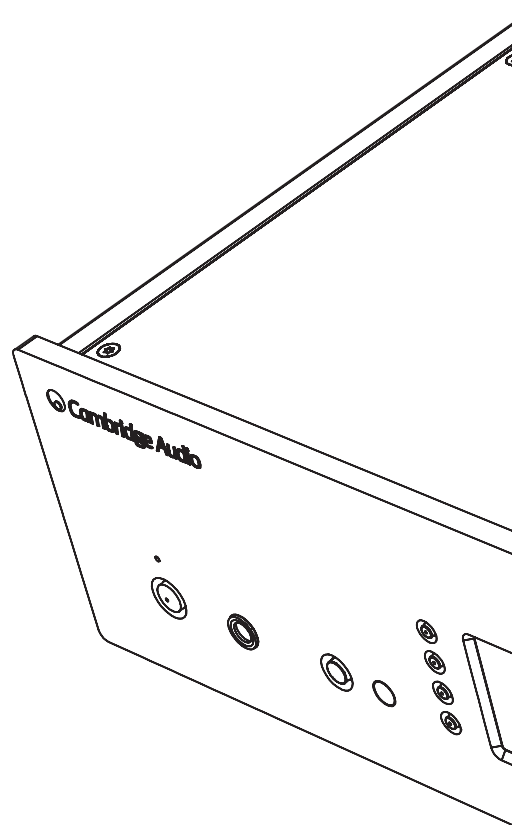

© 2008 Cambridge Audio Ltd

AP21424/3

Free Manuals Download Website

<http://myh66.com>

<http://usermanuals.us>

<http://www.somanuals.com>

<http://www.4manuals.cc>

<http://www.manual-lib.com>

<http://www.404manual.com>

<http://www.luxmanual.com>

<http://aubethermostatmanual.com>

Golf course search by state

<http://golfingnear.com>

Email search by domain

<http://emailbydomain.com>

Auto manuals search

<http://auto.somanuals.com>

TV manuals search

<http://tv.somanuals.com>