

DIGITAL VIDEO CAMCORDER

Instruction Manual

ENGLISH

E

CAMESCOPE ET LECTEUR VIDEO NUMÉRIQUES

Mode d'emploi

FRANÇAIS

F

VIDEOCÁMARA Y GRABADORA DIGITAL

Manual de Instrucciones

ESPAÑOL

Es

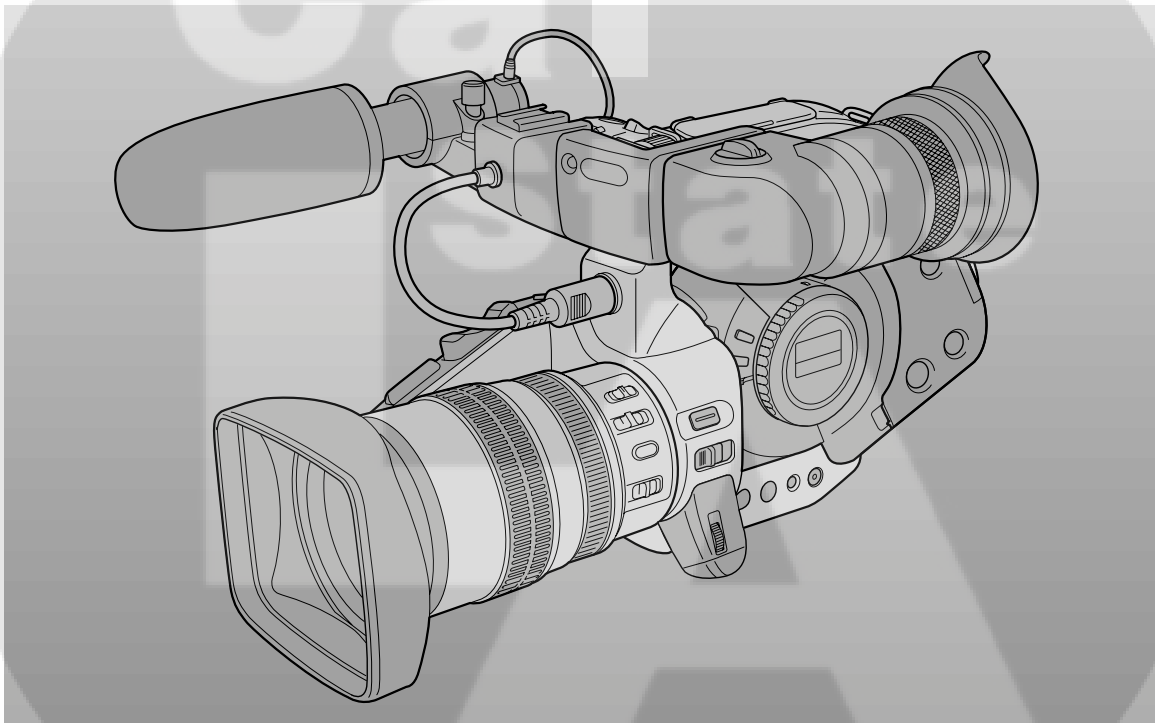

Canon

XL1S

Mini DV Digital
Video
Cassette

A (NTSC)

This instruction book explains the use of the Complete Kit (XL1S plus the color viewfinder and 16× 1S II zoom lens) and the Body Kit (XL1S alone). Please note the illustration and descriptions in this book refer to the Complete Kit.

The Body kit is available only in the U.S.A.

Ce mode d'emploi vous explique comment utiliser le kit complet (XL1S plus viseur couleur et objectif zoom 16× 1S II) et le kit de boîtier (XL1S seulement). Veuillez noter que les illustrations et les descriptions de ce manuel représentent le kit complet.

Le kit de boîtier n'est disponible qu'aux Etats-Unis.

Este manual de instrucciones explica el uso del Equipo Completo (XL1S más el visor en color y el objetivo zoom IS II de 16×) y del Body Kit (sólo la XL1S). Tenga a bien tener presente que las ilustraciones y las descripciones de este manual se refieren al Equipo Completo.

Únicamente en el "equipo completo"

Important Usage Instructions

E

WARNING:



TO REDUCE THE RISK OF FIRE OR ELECTRIC SHOCK, DO NOT EXPOSE THIS PRODUCT TO RAIN OR MOISTURE.

WARNING:



TO REDUCE THE RISK OF ELECTRIC SHOCK AND TO REDUCE ANNOYING INTERFERENCE, USE THE RECOMMENDED ACCESSORIES ONLY.

COPYRIGHT WARNING:

Unauthorized recording of copyrighted materials may infringe on the rights of copyright owners and be contrary to copyright laws.

Digital Video Camcorder, XL1SA Systems.

This device complies with Part 15 of the FCC Rules. Operation is subject to the following two conditions: (1) This device may not cause harmful interference, and (2) this device must accept any interference received, including interference that may cause undesired operation.

Note: This equipment has been tested and found to comply with the limits for class B digital device, pursuant to Part 15 of the FCC Rules. These limits are designed to provide reasonable protection against harmful interference in a residential installation. This equipment generates, uses and can radiate radio frequency energy and, if not installed and used in accordance with the instructions, may cause harmful interference to radio communications. However, there is no guarantee that interference will not occur in a particular installation. If this equipment does cause harmful interference to radio or television reception, which can be determined by turning the equipment off and on, the user is encouraged to try to correct the interference by one or more of the following measures:

- Reorient or relocate the receiving antenna.
- Increase the separation between the equipment and receiver.
- Connect the equipment into an outlet on a circuit different from that to which the receiver is connected.
- Consult the dealer or an experienced radio/TV technician for help.

Use of shielded cable is required to comply with class B limits in Subpart B of Part 15 of FCC Rules.

Do not make any changes or modifications to the equipment unless otherwise specified in the manual.

If such changes or modifications should be made, you could be required to stop operation of the equipment.

Canon U.S.A. Inc.

One Canon Plaza, Lake Success, NY 11042, U.S.A.

Tel No. (516)328-5600

CAUTION:

TO PREVENT ELECTRIC SHOCK, MATCH WIDE BLADE OF PLUG TO WIDE SLOT, FULLY INSERT.

Important Warning



The lightning flash with arrowhead symbol, within an equilateral triangle, is intended to alert the user to the presence of uninsulated "dangerous voltage" within the product's enclosure, that may be of sufficient magnitude to constitute a risk of electric shock to persons.

CAUTION:

TO REDUCE THE RISK OF ELECTRIC SHOCK, DO NOT REMOVE COVER (OR BACK). NO USER-SERVICEABLE PARTS INSIDE. REFER SERVICING TO QUALIFIED SERVICE PERSONNEL.



The exclamation point, within an equilateral triangle, is intended to alert the user to the presence of important operating and maintenance (servicing) instructions in the literature accompanying the product.

IMPORTANT SAFETY INSTRUCTIONS

In these safety instructions the word “product” refers to the Canon Digital Video Camcorder DM-XL1SA and all its accessories.

1. Read Instructions — All the safety and operating instructions should be read before the product is operated.
2. Retain Instructions — The safety and operating instructions should be retained for future reference.
3. Heed Warnings — All warnings on the product and in the operating instructions should be adhered to.
4. Follow Instructions — All operating and maintenance instructions should be followed.
5. Cleaning — Unplug this product from the wall outlet before cleaning. Do not use liquid or aerosol cleaners. The product should be cleaned only as recommended in this manual.
6. Accessories — Do not use accessories not recommended in this manual as they may be hazardous.
7. Avoid magnetic or electric fields — Do not use the camera close to TV transmitters, portable communication devices or other sources of electric or magnetic radiation. They may cause picture interference, or permanently damage the camera.
8. Water and Moisture — Hazard of electric shock — Do not use this product near water or in rainy/moist situations.
9. Placing or Moving — Do not place on an unstable cart, stand, tripod, bracket or table. The product may fall, causing serious injury to a child or adult, and serious damage to the product. A product and cart combination should be moved with care. Quick stops, excessive force, and uneven surfaces may cause the product and cart combination to overturn.
10. Power Sources — The CA-910A Compact Power Adapter should be operated only from the type of power source indicated on the marking label. If you are not sure of the type of power supply to your home, consult your product dealer or local power company. Regarding other power sources such as battery power, refer to instructions in this manual.
11. Polarization — The CA-910A Compact Power Adapter is equipped with a polarized 2-prong plug (a plug having one blade wider than the other). The 2-prong polarized plug will fit into the power outlet only one way. This is a safety feature. If you are unable to insert the plug fully into the outlet, try reversing the plug. If the plug still fails to fit, contact your electrician to replace your obsolete outlet. Do not defeat the safety purpose of the polarized plug.



12. Power Cord Protection — Power cords should be routed so that they are not likely to be walked on or pinched by items placed upon or against them. Pay particular attention to plugs and the point from which the cords exit the product.
13. Outdoor Antenna Grounding — If an outside antenna is connected to the product, be sure the antenna is grounded so as to provide some protection against voltage surges and built-up static charges. Section 810 of the National Electrical Code, ANSI / NFPA No. 70—1984, provides information with respect to proper grounding of the mast and supporting structure, grounding of the lead-in wire to an antenna discharge unit, size of grounding conductors, location of antenna discharge unit, connection to grounding electrodes, and requirements for the grounding electrode. See figure 1.

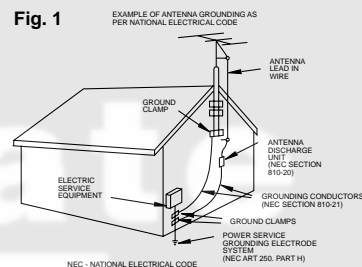

14. Lightning — For added protection of this product during a lightning storm, or when it is left unattended and unused for long periods of time, disconnect it from the wall outlet and disconnect the antenna. This will prevent damage to the product due to lightning and power-line surges.
15. Power Lines — An outside antenna system should not be located in the vicinity of overhead power lines or other electric light or power circuits, or where it can fall into such power lines or circuits. When installing an outside antenna system, extreme care should be taken to keep from touching such power lines or circuits as contact with them might be fatal.
16. Overloading — Do not overload wall outlets and extension cords as this can result in a risk of fire or electric shock.
17. Objects and Liquid Entry — Never push objects of any kind into this product through openings as they may touch dangerous voltage points or short out parts that could result in a fire or electric shock. Be careful not to spill liquid of any kind onto the product.
18. Servicing — Do not attempt to service this product yourself as opening or removing covers may expose you to dangerous voltage or other hazards. Refer all servicing to qualified service personnel.

19. **Damage Requiring Service** — Disconnect this product from the wall outlet and all power sources including battery, and refer servicing to qualified service personnel under the following conditions:
- a. When the power-supply cord or plug is damaged.
 - b. If any liquid has been spilled onto, or objects have fallen into, the product.
 - c. If the product has been exposed to rain or water.
 - d. If the product does not operate normally even if you follow the operating instructions. Adjust only those controls that are covered by the operation instructions. Improper adjustment of other controls may result in damage and will often require extensive work by a qualified technician to restore the product to its normal operation.
 - e. If the product has been dropped or the cabinet has been damaged.
 - f. When the product exhibits a distinct change in performance. This indicates a need for service.
20. **Replacement Parts** — When replacement parts are required, be sure the service technician has used replacement parts that are specified by Canon or that have the same characteristics as the original part. Unauthorized substitutions may result in fire, electric shock or other hazards.
21. **Safety Check** — Upon completion of any service or repairs to this product, ask the service technician to perform safety checks to determine that the product is in safe operating order.

Contents

Introduction

Important Usage Instructions	2
IMPORTANT SAFETY INSTRUCTIONS	3
Thank you for choosing a Canon	7
Introducing the XL1S	8

Preparation

Finding Your Way Around the XL1S	9
Attaching and Detaching the Color Viewfinder Unit... ..	13
Mounting and Unmounting XL Lenses	14
Adjusting the Color Viewfinder Unit	16
Attaching the Provided Microphone	18
Powering the XL1S	19
Loading a Cassette	22
Supporting the Camera.....	24
Using the Menus	25
Using the Wireless Controller/Tally Lamps.....	30
Setting the Date and Time	32

Recording

Basic Recording	35
Zooming (for Zoom Lenses)	38
Turning the SuperRange Optical Image Stabilizer On/Off (16× IS II lens)	40
Using the ND Filter (for appropriate lenses)	41
Taking Still Pictures (Photo Mode)	42
Choosing the Movie Mode (Normal/Frame)	44
Searching and Reviewing While Recording	45
Using the Various Recording Programs	46
Easy Recording	49
Auto	49
Manual	49
Spotlight	49
Giving priority to shutter speed (shutter-priority: Tv)	50
Giving priority to the aperture (aperture-priority: Av)	50
Selecting the Audio Mode	51
Setting the Audio Input – Two Channel Recording....	52
Setting the Audio Input – 4 Channel Recording....	53

Making a Sound Check	54
Using the Custom Keys	55
Changing the custom keys setting	55
Operating the CSTM KEY button	56
Fading In and Out Between Scenes	58
Using a Canon Speedlite for Flash Photography (optional)	60
Using the Color Bars	61
Recording the Viewfinder Information	62
Recording with the Interval Timer	63
Setting the Self-Timer	64
Using the DV Control	65

~ When Making Manual Adjustments ~

Adjusting the Focus (for autofocus lenses)	66
Adjusting the Exposure	67
Using AE Shift	68
Using the Custom Preset	69
Using the Zebra Pattern	71
Recording the PC Screen or other equipment using CLEAR SCAN	72
Adjusting the Gain	73
Adjusting the White Balance	74

Playback

Playing back a Cassette	76
Displaying Date, Time and Camera Data (Data Code)	79
Searching the Tape (Photo Search/Date Search/Index Search)	81
Returning to a Pre-Marked Position.....	82
Connections for Playback on a TV Screen	83

Editing

Editing to a VCR	84
Dubbing to/from a Cassette with Digital Video Equipment	86
Recording from a VCR, TV or Analog Camera (Analog Line-in).....	88

E

Introduction

Recording Over Existing Scenes

(AV Insert Editing)	90
Audio Dubbing	93
Selecting the Audio Output	96

Additional Information

Notes on Using the Batteries	98
Camera Holding Styles	101
Function settings saved at POWER off or with the STANDBY button	102
Maintenance	104
Cautions	104
Storage	104
Maintenance	105
Using the camera abroad	105
Condensation	106
Troubleshooting	107
The XL1S System Diagram (Availability differs from area to area)	110
Optional Accessories	111
Screen Displays	114
Specifications	120
Index	121
Menu at a Glance	122

5151 State University Drive Los Angeles, CA

www.calstatela.edu

The serial number of this product may be found on the bottom of the camera. No others have the same serial number as yours. You should record the number and other vital information here and retain this book as a permanent record of your purchase to aid identification in case of theft.

Date of Purchase
Dealer Purchased From
Dealer Address
Dealer Phone No.
Model Name XL1SA
Serial No.

Thank you for choosing a Canon

E







First, we'd like to thank you for purchasing this Canon camcorder. Its advanced technology makes it very easy to use — you will soon be making high-quality videos which will give you pleasure for years to come.

For quick reference (in addition to the contents and index) please refer to:

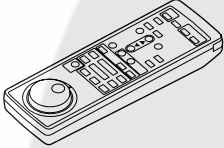
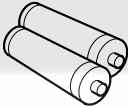
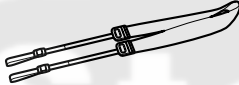

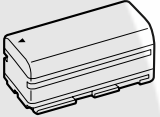
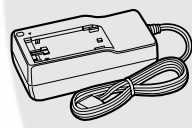

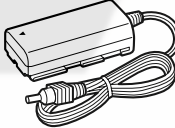
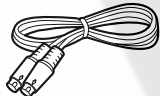
- Finding your way around the camcorder (p. 9)
- Screen displays (p. 114)

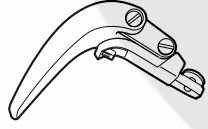
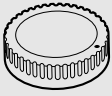
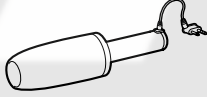
Note that capital letters are used to refer to settings displayed in the menus and buttons labelled on the camcorder itself e.g. Press the EJECT button.

The XL1S is supplied with the following accessories:

WL-D3000 Wireless Controller 	Two AAA batteries 	SS-1000 Shoulder Strap 	Lens cap 	BP-930 Battery Pack 
CA-910 Compact Power Adapter 	Lithium button battery 	DC-900 DC Coupler 	S-150 S-video Cable 	STV-150 Stereo Video Cable 
SP-100 Shoulder pad 	Body cap 	Stereo microphone 		

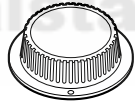
“Complete kit” only

Color Viewfinder 	16× IS II Zoom Lens (with soft case) 	Dust cap 	Lens hood 
---	---	---	---

Introducing the XL1S

E

3CCD System with Pixel Shift Technology

Higher sensitivity, higher SN ratio, higher image resolution and a greater dynamic range results from horizontally shifting the green CCD (270,000 pixels).

Interchangeable Lens System: XL Mount

A variety of XL Mount lens are available providing you with the flexibility needed to shoot high quality video.

EF Adapter (optional)

A valuable accessory is the EF Adapter that fits onto the XL1S to allow you to use Canon EF lenses (that have the manual focusing only). The difference in size between the XL1S' CCD and 35 mm film means that the effective focal length of the EF lens is multiplied by 7.2x.

SuperRange Optical Image Stabilizer

Canon's stabilization technology gives you steadier images even at the furthest reaches of the zoom range. The feedback system boots suppression performance for low frequency vibration.

SLR-Style Flash Photography

Attach a Canon E-TTL flash (420EX or 550EX) to illuminate your subject when shooting still images in the Photo Mode (FA-200 Flash Adapter optionally required).

DV Terminal (IEEE 1394)

XL1S is equipped with a DV terminal that conforms to IEEE 1394. By connecting the XL1S to your computer, you can capture still images or motion images on your PC.

Four-channel Simultaneous Recording

When recording in 12bit-ST1, 2 mode, you can record 4 channels simultaneously. In addition, you can output the 4 channels independently.

Recording modes

XL1S has 6 recording modes : Easy Recording, Auto, Tv, Av, Manual and Spotlight.

Low-angle Recoding

You can make a low-angle recording easily thanks to the start/stop button, zoom button and photo button on the handle.

Custom Keys

You can assign various functions to 2 exclusive buttons (independent for camera mode and VCR mode).

Clear Scan

You can remove the black band that appears when recording a computer screen.

Custom Preset

You can adjust the color gain, color phase, sharpness and setup level. The combination of adjustments can be assigned to 3 buttons.

Zebra Pattern

Areas of overexposure can be shown by diagonal lines in the viewfinder.

VCR Stop

In camera mode, you can stop the recorder section anytime allowing you to adjust the camera section without worrying about the 5-minute timer.

Interval Recording

You can record images over a selected time with a selected interval.

Analog Line-In Recording

Connect to a VCR or analog camcorder and record onto a DV tape in the XL1S.

Audio Dubbing/AV Insert Editions

Add new audio to an original recoding, or replace the original audio & video.

Finding Your Way Around the XL1S

E

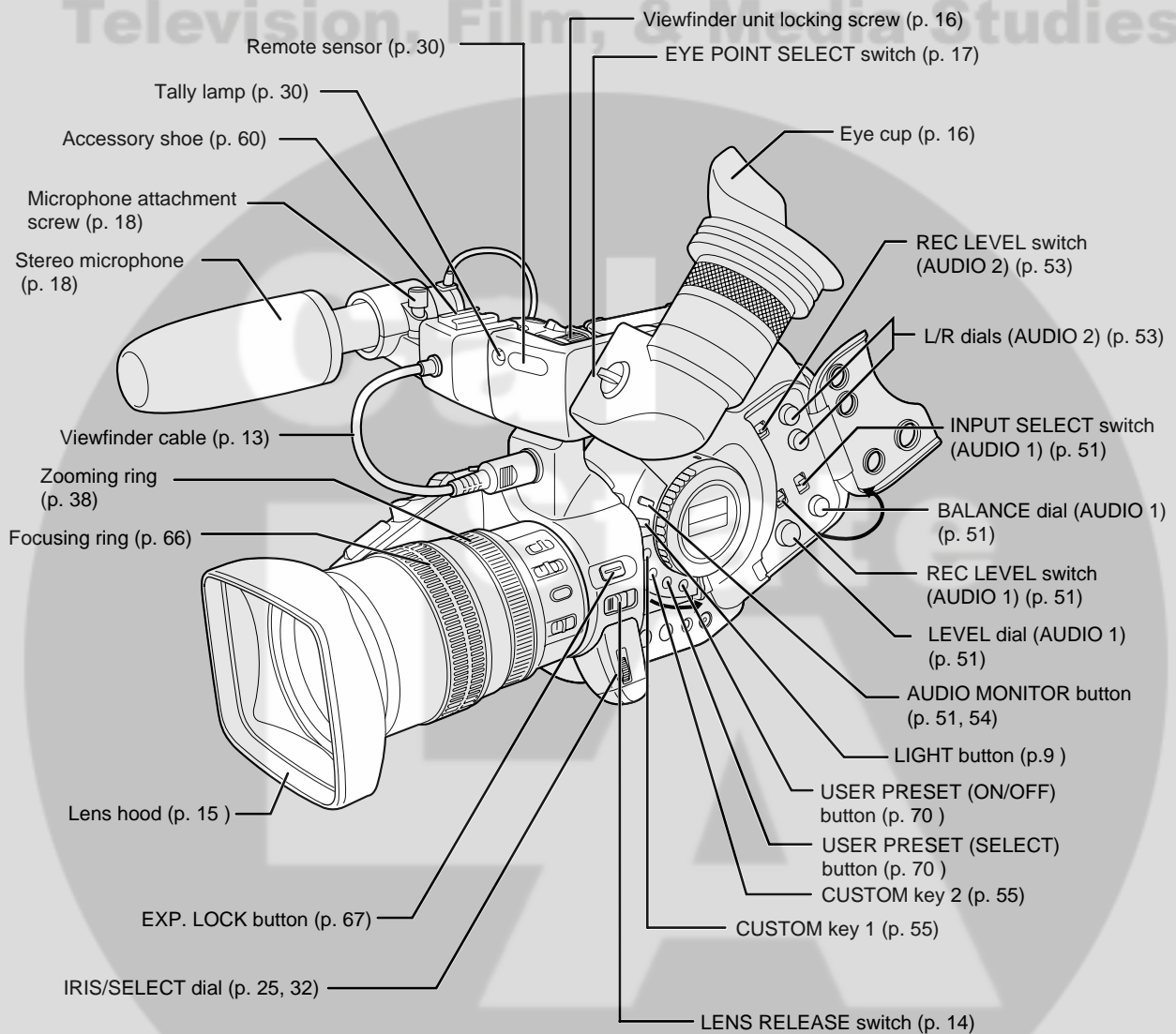

For instructional use only

For instructional use only

Preparation

Light Button

Push the LIGHT button to illuminate the main and audio panels for approximately 10 seconds. If you press and hold the button for at least 3 seconds, the panels remain illuminated until you press the button once more to turn the backlight off.

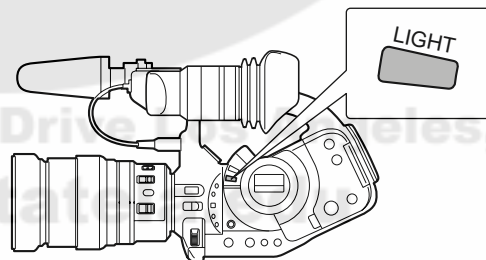

Television, Film, & Media Studies

For instructional use only

For instructional use only

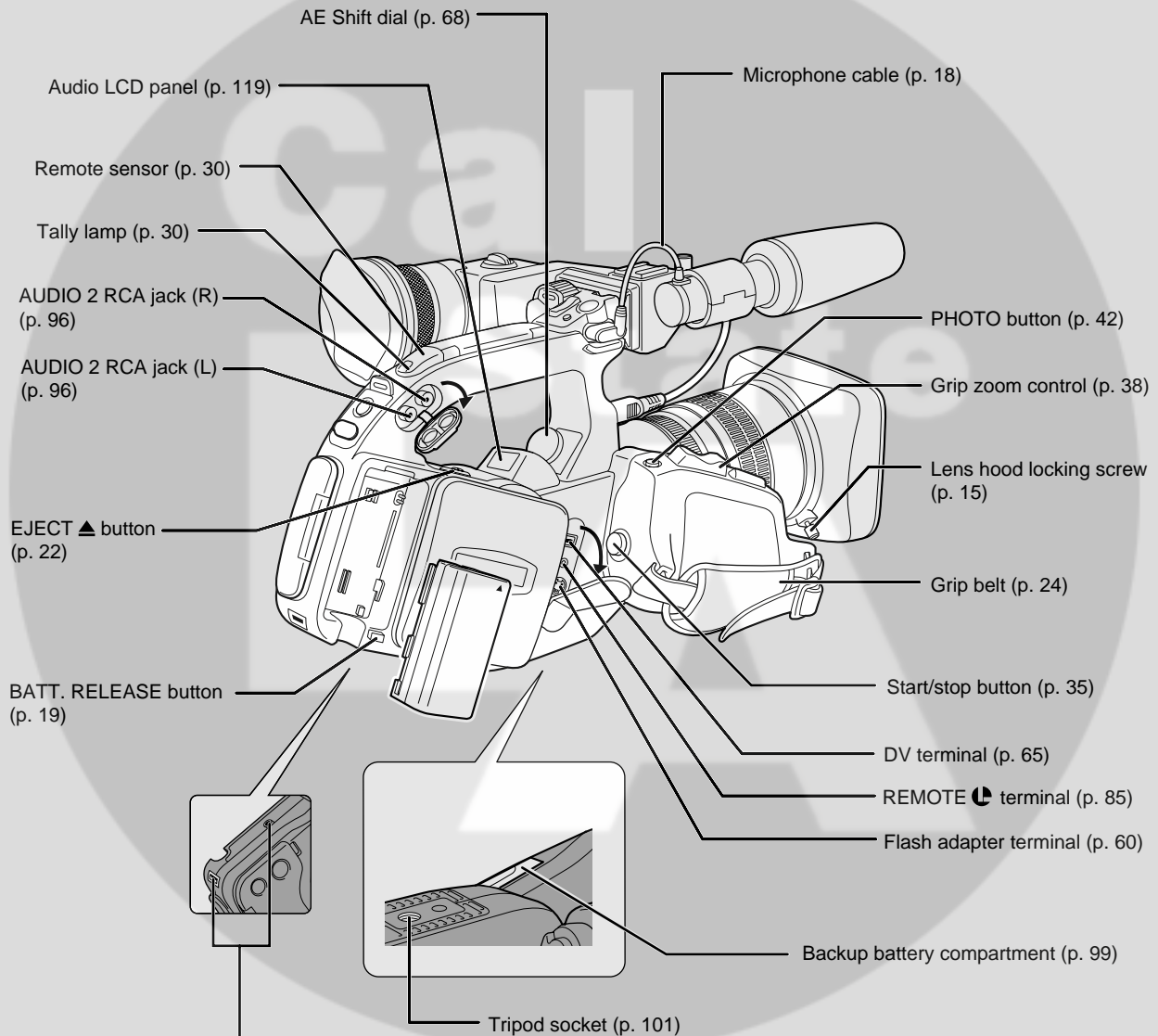

Socket for attaching the SP-100 Shoulder Pad or MA-100 or MA-200 Microphone Adapter/Shoulder Pad. Do not attach a tripod to this socket.

5151 State University Drive Los Angeles, CA
www.calstatela.edu

Television, Film, & Media Studies

For instructional use only

For instructional use only

Preparation

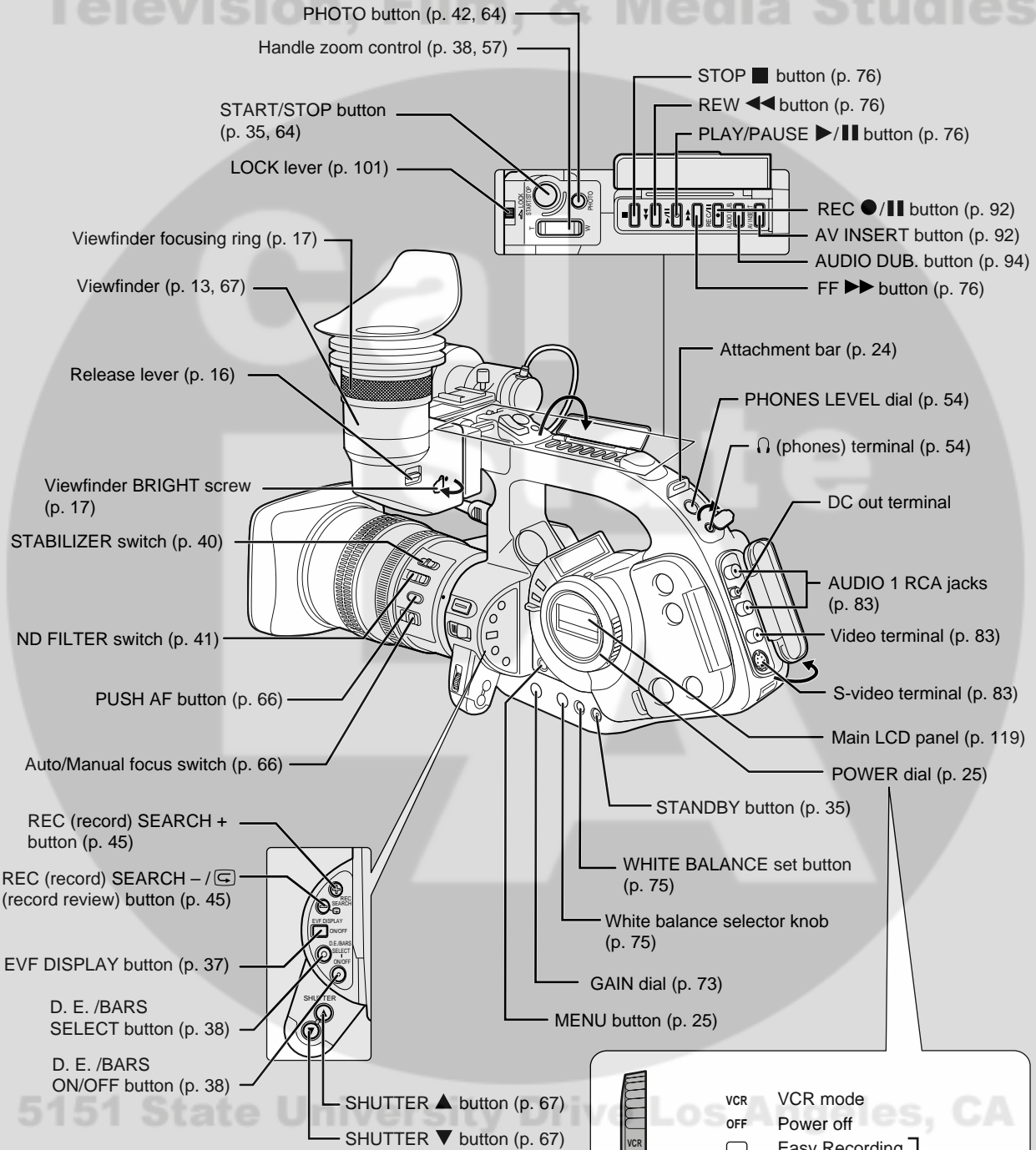

VCR	VCR mode	Recording programs (camera mode)
OFF	Power off	
[Easy Recording icon]	Easy Recording	
[A icon]	Auto	
Tv	Shutter-Priority	
Av	Aperture-Priority	
M	Manual	
[Spotlight icon]	Spotlight	
[POWER icon]	POWER	
[VCR OFF icon]	VCR OFF	

5151 State University Drive, Los Angeles, CA
www.calstate.edu

Television, Film, & Media Studies

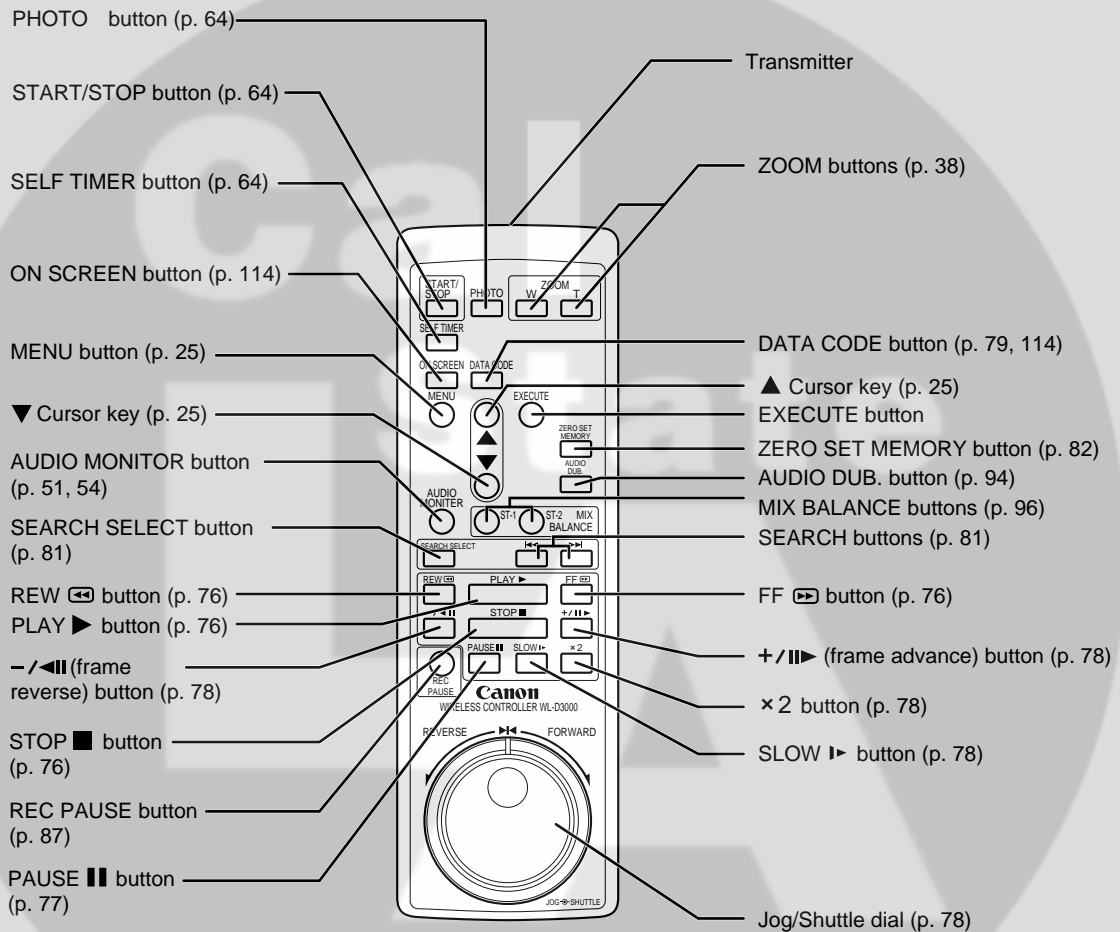

5151 State University Drive Los Angeles, CA
www.calstatela.edu

Attaching and Detaching the Color Viewfinder Unit

- If you are a Body Kit user, refer to the viewfinder instruction manual.

E

Attaching the Color Viewfinder Unit

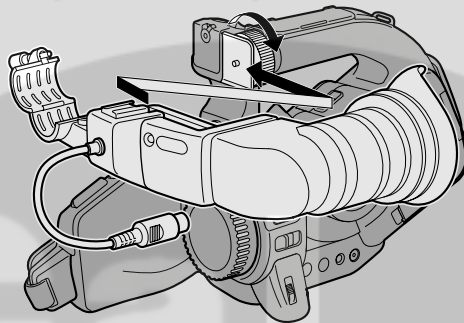

1. Slide the viewfinder unit onto the bracket and tighten the locking screw to hold the unit in place.

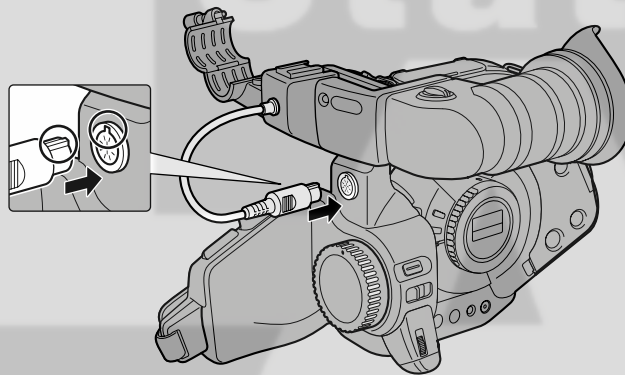

2. Connect the viewfinder cable to the socket at the front of the camera body.

Detaching the Viewfinder Unit

1. Detach the viewfinder cable.
2. Loosen the unit locking screw and slide the viewfinder unit off the bracket.

5151 State University Drive Los Angeles, CA
www.calstatela.edu

Preparation

Mounting and Unmounting XL Lenses

E

Any lens bearing the **XL** mark can be used with this camcorder.

- If you are a Body Kit user, please refer to the appropriate lens instruction manual. Note that the lens functions vary by the lens type.

Mounting the lens

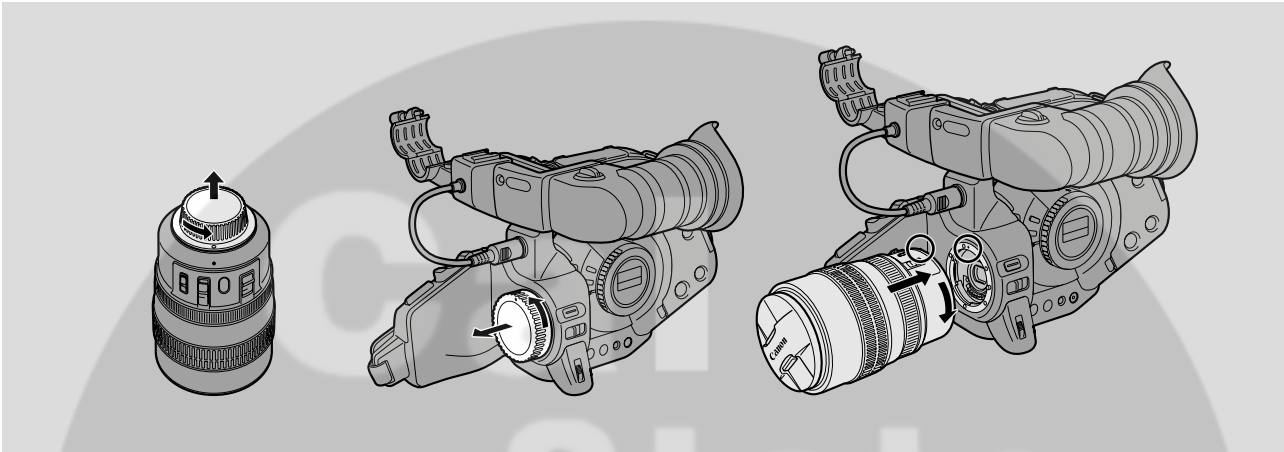

1. Remove the dust cap from the lens and the body cap from the camcorder.
2. Align the red dot on the camera body with the mount positioning point (the red dot) on the lens, then turn the lens clockwise until it clicks and locks into place.

Unmounting the lens

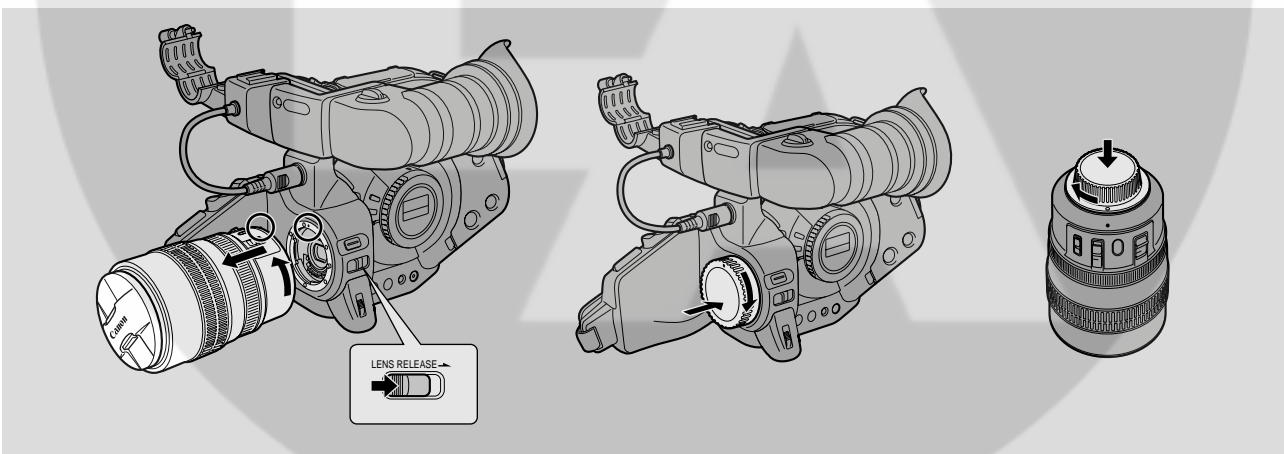

1. Slide and hold the **LENS RELEASE** switch and turn the lens counter-clockwise until it stops. Then, remove the lens from the camera body.
2. When you are not using the lens or camera, be sure to replace the dust cap and body cap.

Attaching the Lens Hood

E

Television, Film, & Media Studies

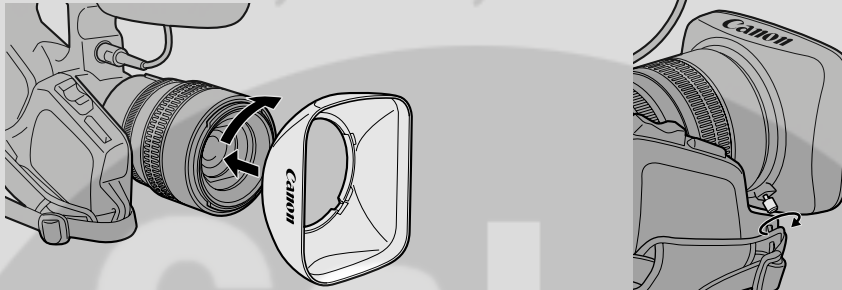

1. **Remove the lens cap.**
2. **Align the hood with the lens lengthways, and the Canon logo facing to the left.**
3. **Twist it 90° into position (clockwise), so that the Canon logo is to the top.**
 - You do not need to assert any pressure — screw the hood lightly into place.
4. **Finally, tighten the locking screw.**
 - To remove, reverse the above procedure.

Since the lens hood cuts stray light that may cause flare and ghost images and protects the lens, be sure to attach the hood when you are recording.

Lens settings

There are four functions which can only be adjusted using controls on the lens:

- Optical Image stabilizer (p. 40)
- ND Filter (p. 41)
- Push Autofocus (p. 66)
- Manual Focus (p. 66)

Notes:

- Make sure that the camera is turned off before mounting or removing the lens.
- To avoid damaging the lens or camera, place them on a table or secure surface when mounting or removing the lens.
- Use only lenses bearing the **XL** mark. You cannot use VL mount lenses with this camcorder.
- If you turn the camera on without a lens attached the caution “CHECK THE LENS” is displayed for a few seconds. “LENS” then flashes continuously in the viewfinder. Turn the camera off and mount a lens. (“LENS” also flashes if only the optional EF Adapter XL or Extender XL 1.6 × is attached.)

When the lens is removed from the camcorder, avoid contact with the exposed parts inside the camera (such as the CCD area). If such parts require cleaning, do so with a commercially available lens cleaning kit, making sure that the camera is turned off first.

Adjusting the Color Viewfinder Unit

E

Adjusting for left eye/right eye operation

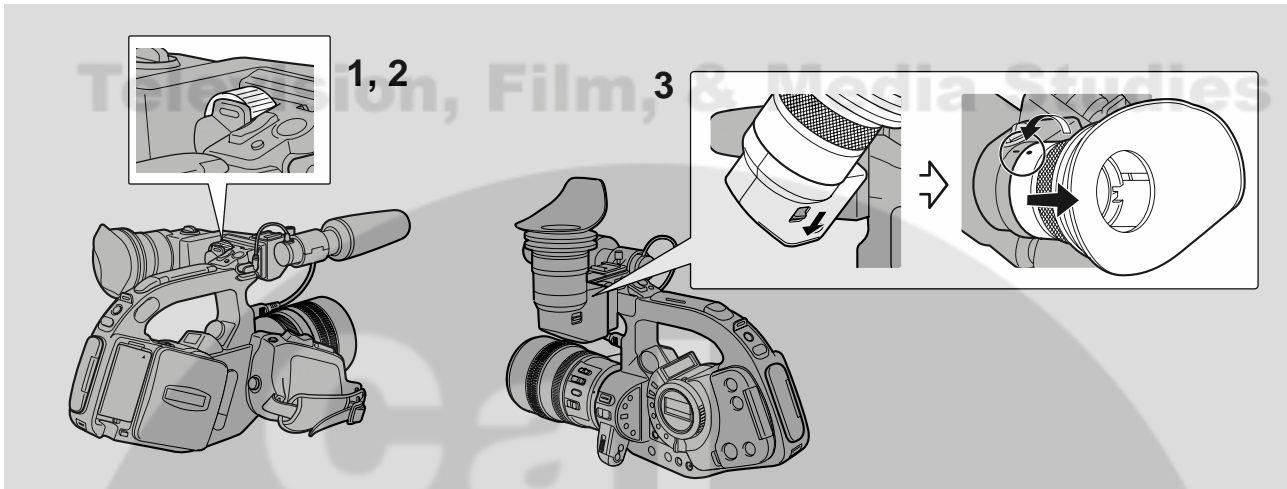

You can slide the viewfinder unit along the bracket to a position that best suits you — for use with either the left or right eye.

- 1. Loosen the locking screw and slide the unit to the position you require along the bracket.**
- 2. Tighten the locking screw.**
- 3. Switch the eye cup around (if necessary).**
 - Slide and hold the release lever on the underside of the viewfinder and then twist the eye cup counter-clockwise (until the mark on the eye cup lines up with the mark on the viewfinder) to allow you to remove it from the viewfinder. Replace, with the eye cup facing the opposite direction, by lining up the marks and twisting the cup clockwise until it locks into place.

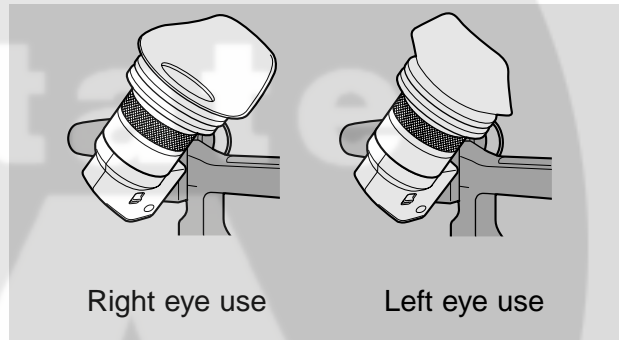

5151 State University Drive Los Angeles, CA
www.calstatela.edu

Adjusting to your viewing point

To monitor the scene with your eye near to the viewfinder turn the EYE POINT SELECT switch to NEAR. To view the scene at a distance from the viewfinder, turn the switch to FAR.

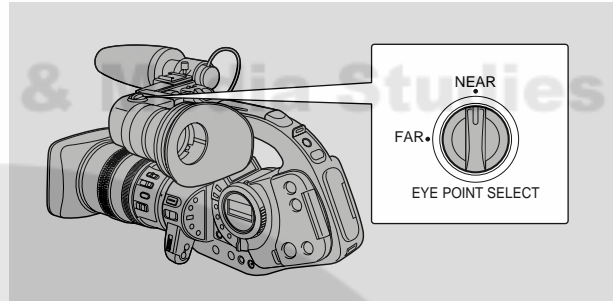

Adjusting to your eyesight

- In record pause mode, turn the viewfinder focusing ring (focusing the display between -5 and +2) to suit your eyesight.
- The viewfinder rotates through 270° to give a choice of shooting positions.

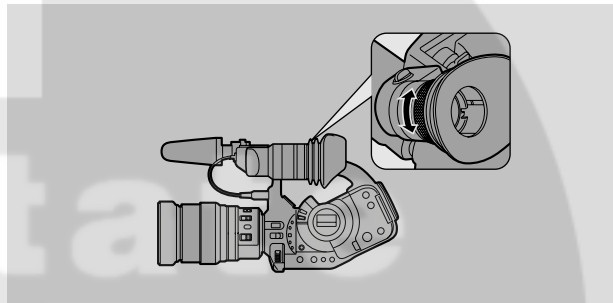

Adjusting the viewfinder color

MENU

(see p. 27)



1. Open either the camera menu or the VCR menu, and select **DISP. SET UP**.
2. Select **EVF COLOR**, then adjust the color by turning the IRIS/SELECT dial.
3. Close the menu.

- Turn the IRIS/SELECT dial up to make the viewfinder reddish, and down to make it greenish.

Adjusting the viewfinder brightness

- Adjust the brightness of the display by turning the BRIGHT screw. You can reveal the screw on the under side of the viewfinder by pulling back the small screw cover.

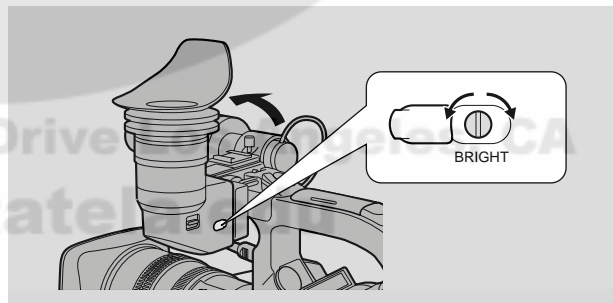

Attaching the Provided Microphone

E

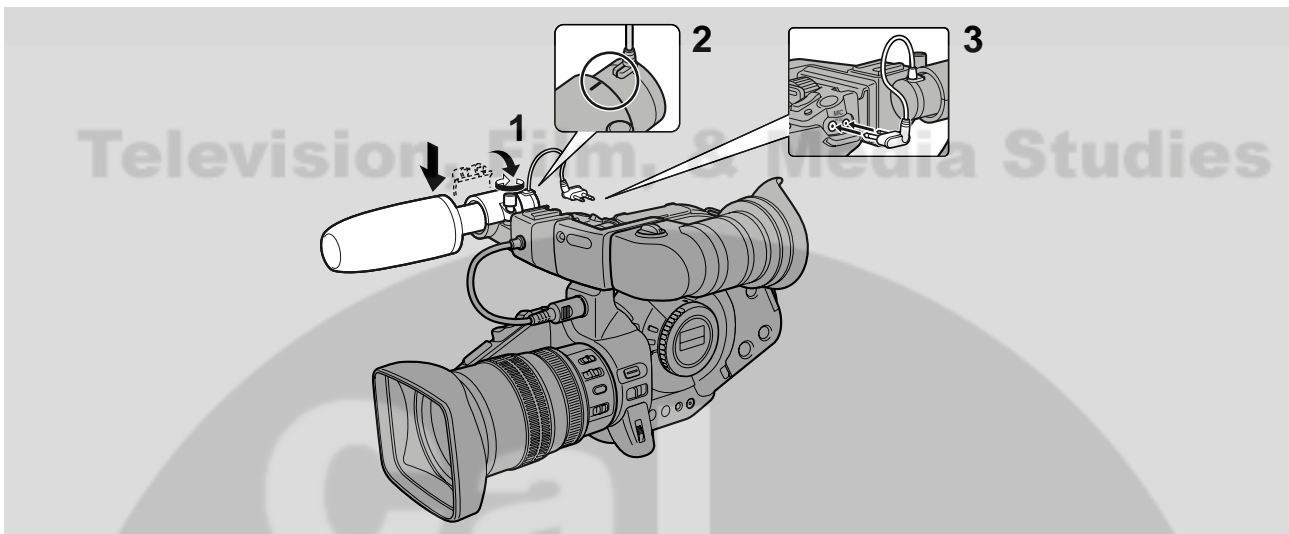

1. Loosen the microphone attachment screw on the viewfinder unit and insert the microphone into the microphone clamp.
2. Align the mark on the microphone with the mark on the clamp and tighten the screw to hold the microphone firmly in place.
3. Plug the microphone cable to the camera's MIC terminals.

Note:

- Make sure that the camera is turned off before attaching or removing the microphone cable.

Preparation

5151 State University Drive Los Angeles, CA
www.calstatela.edu

Powering the XL1S

Before operating your camera, you will need to use the power adapter to:

provide power from an AC outlet

or

charge a battery pack

Notes:

- The power adapter converts current from a household power socket (100–240 V AC, 50/60 Hz) to the DC current used by your camera.
- If the adapter is used next to a TV, it may cause the TV to emit noise — move the adapter away from the TV or the antenna cable.

Connecting the camera to an AC outlet

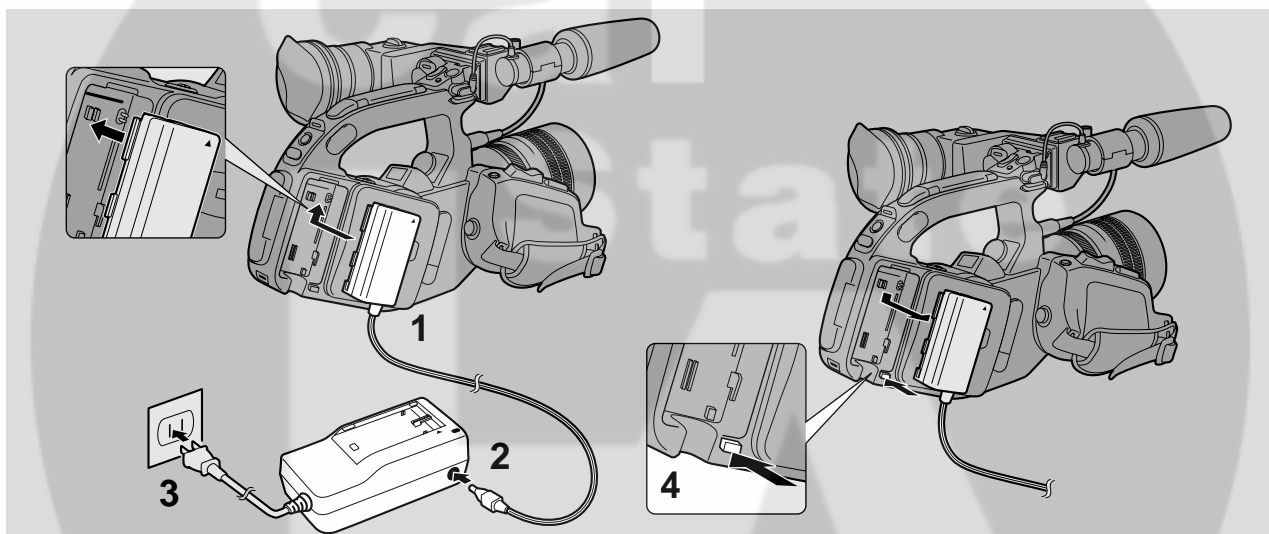

Use the power adapter and the DC coupler to provide your camera with instant power from an AC outlet.

1. Attach the DC coupler to the camera.

- Align the triangle on the DC coupler with the line on the camera.
- Slide the coupler in the direction of the arrow, until it clicks into place.

2. Connect the DC coupler to the adapter.

3. Plug the adapter into an AC outlet.

4. Detach the DC coupler after use.

- Press and hold the BATT. RELEASE button, while you slide the coupler down.
- Always turn the camera off before removing the power source.

5151 State University Drive Los Angeles, CA
www.calstatela.edu

E

Preparation

Charging and attaching the battery pack

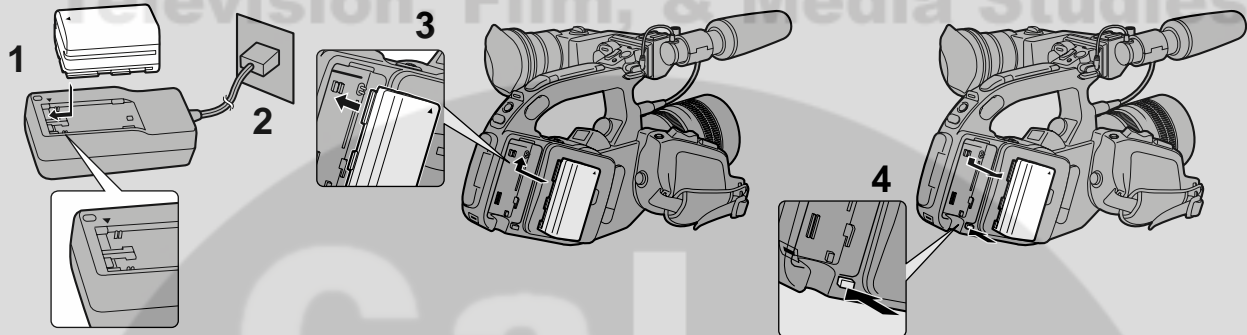

Your battery pack was partially charged before it left the factory. It should have enough power for you to check that your camera is working properly. However, you must charge the battery pack fully if you want it to power the camera for more than a few minutes.

1. Attach the battery pack to the power adapter.

- Align the triangle on the battery pack with the line on the power adapter.
- Slide the battery across until it clicks into place.
- Make sure the DC coupler is not connected.

2. Plug the adapter into an AC outlet.

- The charge indicator flashes red to show that charging is in progress. Single flashes mean that the battery pack is less than 50% charged. Double flashes mean that it is between 50% and 75% charged. Triple flashes mean that it is more than 75% charged.
- The indicator glows steadily when the battery pack is fully charged.

3. Take the battery pack off the adapter and attach it to the camera.

- Align the triangle on the battery pack with the line on the camcorder, then slide the battery up in the direction of the arrow until it clicks into place.

4. Remove the battery pack after use.

- Press and hold the BATT. RELEASE button, while you slide the battery down.
- Always turn the camera off before removing the power source.

Notes:

- You can find detailed notes for using the batteries in the “Notes on Using the Batteries” on p. 98. These notes include charging and recording times and how to install the back-up battery.
- Using the optional CH-910 Dual Battery Charger/Holder you can power the camera from two battery packs for longer continuous recording. You can exchange the battery packs independently without cutting the power to the camcorder. In addition, the CH-910 can charge two batteries consecutively when it is connected to an AC outlet.

CA-910 Compact Power Adapter

E

Specifications

Power supply	100–240 V AC, 50–60 Hz
Power consumption	16 W
Rated output	Adapter mode: 6.0 V, 1.7 A DC Charger mode: 8.4 V, 1.2 A DC
Operating temperature range	32°F–104°F (0°C–40°C)
Dimensions	2 1/2 × 5 × 1 3/4 in (63 × 127.5 × 43 mm)
Weight	10 7/8 oz (310 g)

Weight and dimensions are approximate.
Errors and omissions excepted.
Subject to change without notice.

When replacement of power supply is required, please return it to the responsible nearest Canon Service Center and please replace it with the same type number CA-910 or equivalent.

The Adapter can be used with a power supply between 100 and 240 V AC. For areas where 120 V AC power is not used, you will need a special plug adapter.
Contact your nearest Canon Service Center for further information.

For instructional use only

For instructional use only
Preparation

5151 State University Drive Los Angeles, CA
www.calstatela.edu

Loading a Cassette

E

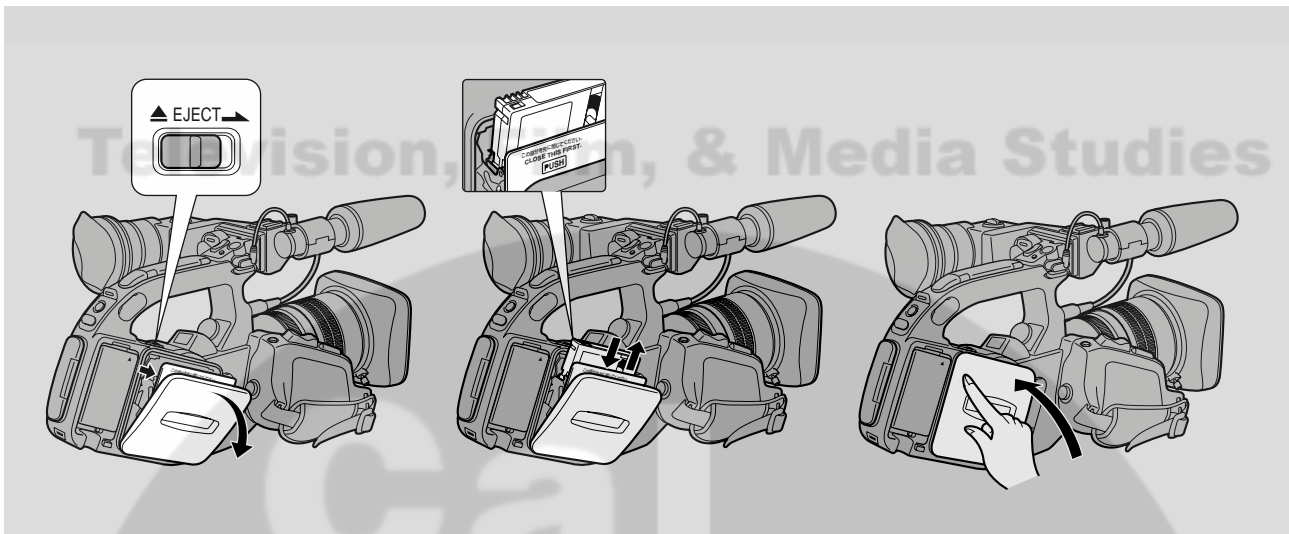

Use videocassettes marked with the ^{Mini}DV logo only.*

Loading and unloading

1. Make sure that you have inserted a power source.
2. Slide the **EJECT** ▲ button across to release the cover.
 - Wait a couple of seconds for the cassette compartment to open automatically.
3. Load or unload the cassette.
 - Insert the cassette gently with the window facing out.
 - Remove the cassette by pulling it straight out.
4. Press the **PUSH** mark on the compartment until it clicks.
5. Click the cover back into place.

* ^{Mini}DV is a trade mark.

Notes:

- After loading a cassette, use record search (p. 45) to find the point where you want to start recording.
- Do not interfere with the cassette compartment while it is opening or closing automatically, or attempt to close the cover.
- Do not leave the cassette in the camera after use — return it to its case and store it in a cool, clean, dry place.
- Close the inner door before closing the outer door.

5151 State University Drive Los Angeles, CA
www.calstatela.edu

Protecting tapes from accidental erasure

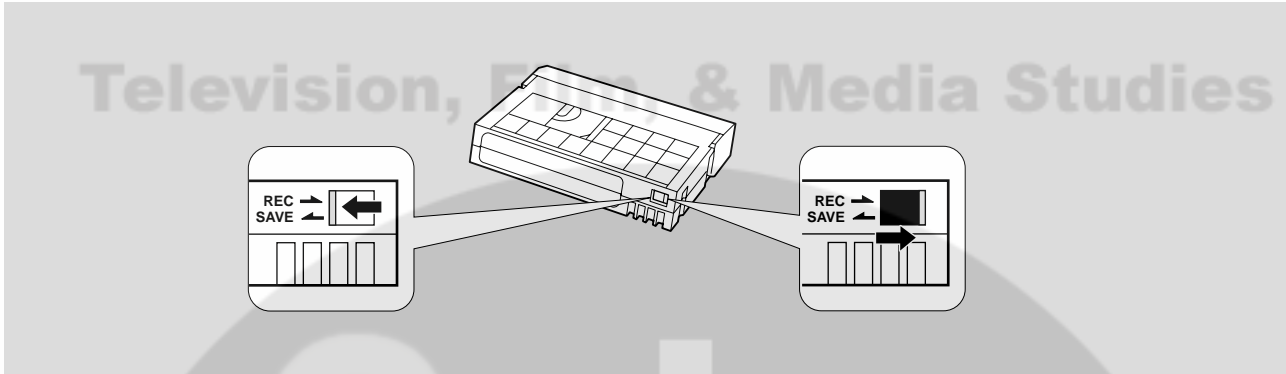

To protect your recording from accidental erasure, slide the tab on the cassette so that it exposes the hole and the red mark. (This switch position is usually labeled SAVE or ERASE OFF.)

If you load this cassette and put the camera in record pause mode (p. 35), “THE TAPE IS SET FOR ERASURE PREVENTION” is displayed for approx. 4 seconds and then the  mark flashes in the display. The camera also shows the above phrase if you accidentally press the ● (record) button with the camera switched to VCR mode.

If you want to record on the cassette again, slide the tab back so the hole is closed, and the red mark covered.

Handling cassettes

- To protect the tape heads, transfer cassettes directly from the tape case to the camcorder — do not open the tape protect cover or touch the tape itself.
- Do not use cassettes where the tape has been damaged or rejoined — they may damage the camcorder.
- Do not insert anything into the small holes on the cassette or cover them with cellophane tape.
- Handle cassettes with care — dropping them or exposing them to external shocks may cause internal damage.
- Store cassettes in the provided case, rewinding them to the start of the tape first, and then storing them upright.
- A cassette with metal plated terminals may become dirty with use, affecting information transfer. Therefore, after using a tape around ten times, be sure to clean the terminals with a cotton wool bud.

Cassette memory

You are unable to use the cassette memory function with this camcorder.

5151 State University Drive Los Angeles, CA
www.calstatela.edu

Supporting the Camera

E

Prepare the lens cap

- Attach/remove the lens cap as shown.

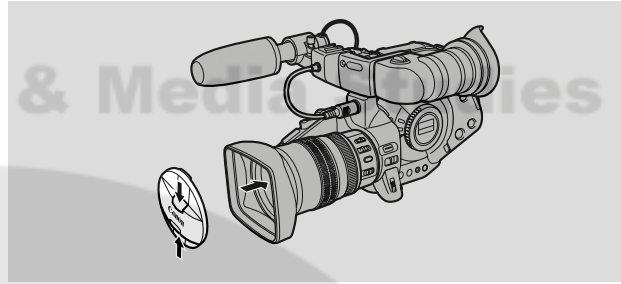

Attach the SP-100 shoulder pad

- For extra comfort and control, attach the shoulder pad to the camera.
- Clip the adapter unit onto the base of the camcorder and tighten the fixing screw using a coin.
- When you are not using the shoulder pad, fold it in towards the camera until it clicks into the storage position.

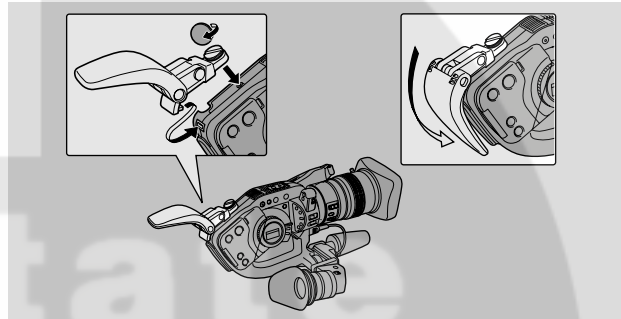

Adjust the grip belt

- Adjust the length of the grip belt strap so that you can operate the start/stop button and zoom control effectively.

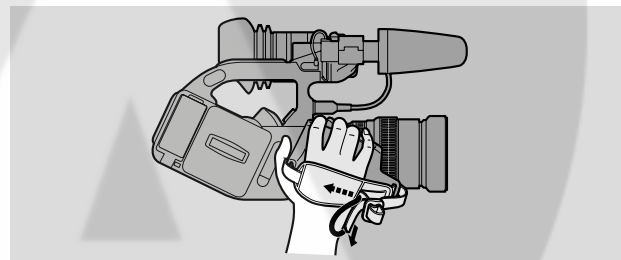

Attach the shoulder strap

- For extra security and portability, attach the shoulder strap before using the camera.
- Pass the ends through the attachment bars and adjust the length as shown.

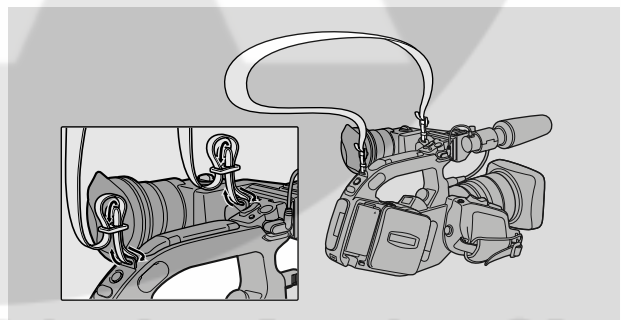

Notes:

- Be careful not to leave the viewfinder exposed to bright sunlight, or it may damage the LCD. (The light is concentrated by the viewfinder lens.) Either turn the EYE POINT SELECT switch to the FAR setting, or change the angle of the viewfinder to move it out of direct sunlight.
- Place the camera on a table or secure surface when attaching the shoulder pad, grip belt or strap.

Using the Menu

E

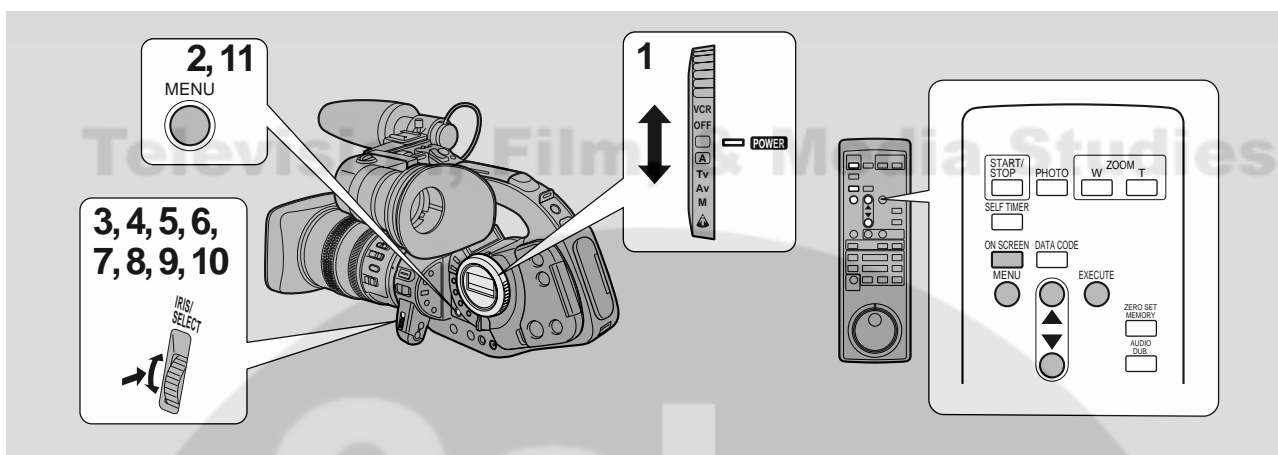

Selecting from the Menu

1. Turn the **POWER** dial to a recording program or to **VCR**.
2. Press the **MENU** button to open the menu.
 - One of the main menu appears, according to the **POWER** dial setting.
3. Turn the **IRIS/SELECT** dial and move the arrow to the desired submenu.
4. Press the **IRIS/SELECT** dial in to select.
 - The submenu appears.
5. Turn the **IRIS/SELECT** dial and move the arrow to the desired function.
6. Press the **IRIS/SELECT** dial in to select.
 - The function and its settings only appear.
7. Turn the **IRIS/SELECT** dial and move the arrow to the desired setting.
8. Press the **IRIS/SELECT** dial in to select.
 - The function is set to and you return to the submenu.
9. Turn the **IRIS/SELECT** dial and select the arrow to **← RETURN**.
10. Press the **IRIS/SELECT** dial in to select.
 - You return to the main menu.
11. Press the **MENU** button.
 - The main menu disappears.

Notes:

- Pressing the **MENU** button at any time closes the menu.
- Selecting **← RETURN** takes you back one menu, or closes the main menu.
- Items that are unavailable due to the setting of other menu items or program AE modes, appear in purple.
- You may find it convenient to use the wireless controller to move around the menus. Press the **MENU** button to open/close the menu and use the arrow keys to in place of turning the **IRIS/SELECT** dial. Push the **EXECUTE** button to select.
- Pressing the start/stop button or the **PHOTO** button will close the menu and start recording.
- You can display the menus on a connected TV screen by turning **TV SCREEN** on through the menu or using the wireless controller's **TV SCREEN** button. See p. 88 for TV hookup instructions.

List of Menus

Turn to the appropriate page for a detailed explanation of each function.

● CAM. MENU

Appears when the POWER dial is set to camera mode.

There are 6 (+1) submenus within the CAM. MENU.

- ① To camera set up submenu
- ② To custom preset submenu
- ③ To VCR set up submenu
- ④ To display set up submenu
- ⑤ To system submenu
- ⑥ To custom key submenu
- ⑦ Close the main menu

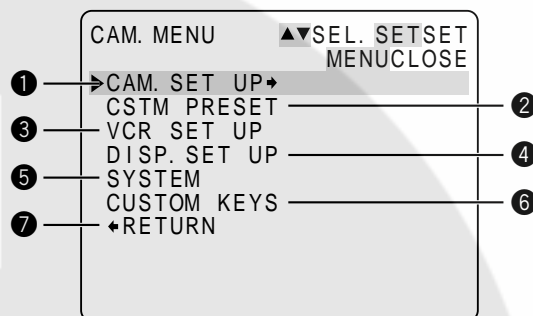

- ① Camera set up submenu
 - ① Movie mode
 - ② 16:9 effect
 - ③ Zebra pattern
 - ④ Zebra pattern level
 - ⑤ Grip zoom control
 - ⑥ Handle-top zoom control
 - ⑦ Clear scan
 - ⑧ Return

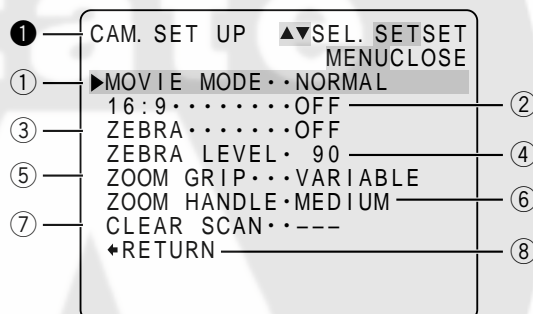

- ② Custom preset submenu
 - ⑨ Preset No.
 - ⑩ Color gain
 - ⑪ Color phase
 - ⑫ Sharpness
 - ⑬ Setup level
 - ⑭ Return

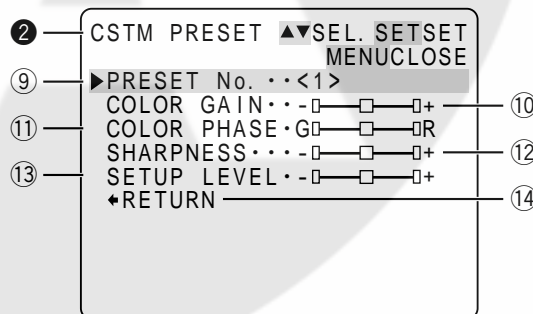

- ③ VCR set up submenu
 - ⑮ Record mode
 - ⑯ Audio mode
 - ⑰ Audio 1 input sensitivity
 - ⑱ Audio 2 input sensitivity
 - ⑲ Power save
 - ⑳ Self timer
 - ㉑ To INTERVAL TIMER submenu
 - ㉒ Return

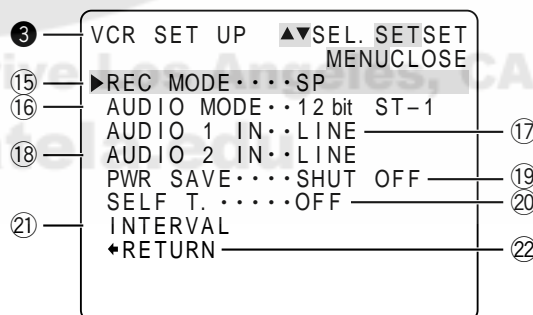

- ④ Display set up submenu
- ②③ EVF color
- ②④ 16:9 guide line display
- ②⑤ TV screen
- ②⑥ Guide information
- ②⑦ Return

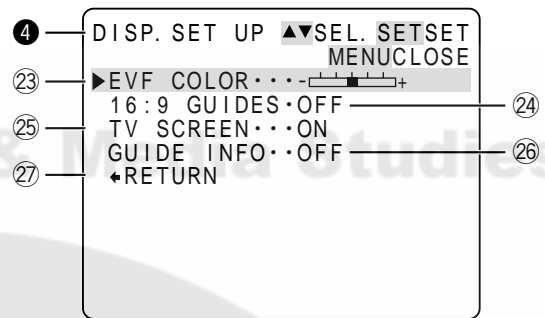

- ⑤ System submenu
- ②⑧ Sensor
- ②⑨ Tally lamp
- ③⑩ Character recording
- ③① DV control
- ③② Time zone/Daylight saving time
- ③③ Date/time set
- ③④ Return

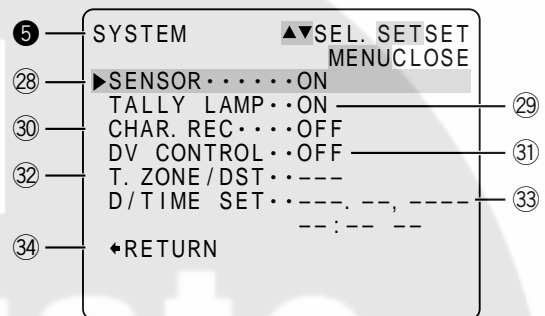

- ⑥ Custom key submenu
- ③⑤ Custom key 1 select
- ③⑥ Custom key 2 select
- ③⑦ Return

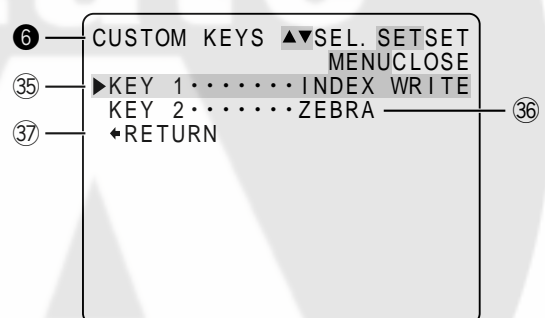

E**● VCR MENU**

Appears when the POWER dial is set to VCR.
There are 4 submenus within the VCR MENU.

- ① To VCR set up submenu
- ② To display set up submenu
- ③ To system submenu
- ④ To custom key submenu
- ⑤ Close the main menu

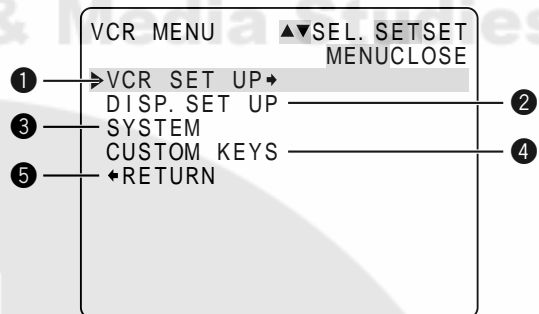

- ① VCR set up menu
- ① Record mode
- ② Output channel
- ③ Audio 1 in sensitivity
- ④ Audio 2 in sensitivity
- ⑤ Mix select
- ⑥ Audio mode
- ⑦ Return

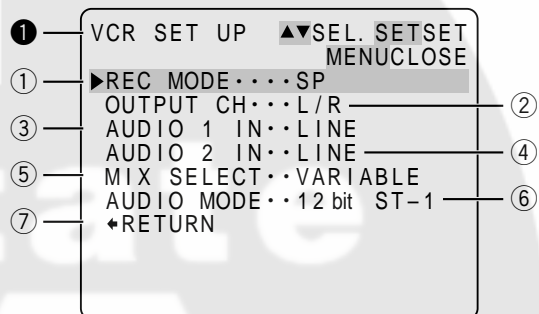

- ② Display set up submenu
- ⑧ EVF color
- ⑨ Displays
- ⑩ 6-second auto date
- ⑪ Data code
- ⑫ Date/time select
- ⑬ Custom keys display
- ⑭ Return

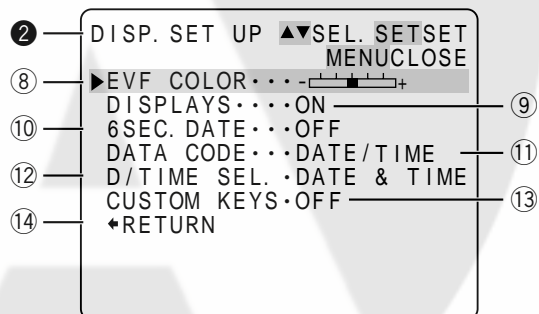

- ③ System submenu
- ⑮ Sensor
- ⑯ Return

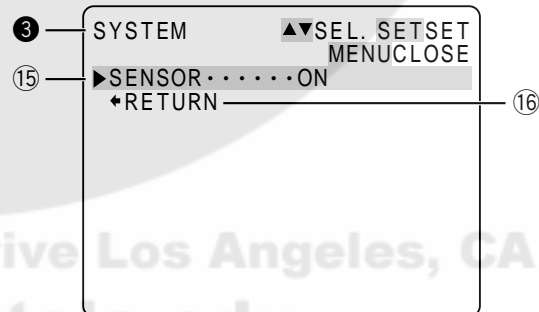

5151 State University Drive Los Angeles, CA
www.calstateia.edu

- ④ Custom key submenu
- ⑰ Custom key 1 select
- ⑱ Custom key 2 select
- ⑲ Return

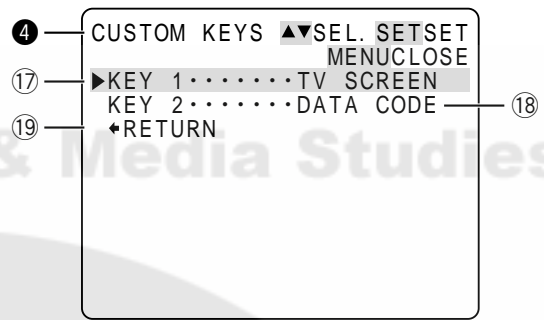

Television, Film, & Media Studies



For instructional use only

For instructional use only
Preparation

5151 State University Drive Los Angeles, CA
www.calstatela.edu

Using the Wireless Controller/Tally Lamps

E

The supplied wireless controller can operate the camera from a distance of up to 16 feet (5 m). Point it at either of the camera's remote sensors while you press the buttons.

The tally lamps light up to let you know that the camera is in range and responding to your commands.

There are five functions which can only be operated using the wireless controller:

- Special playback (p. 78)
- Zero set memory (p. 82)
- Index/photo/date search (p. 81)
- Audio mix (p. 96)

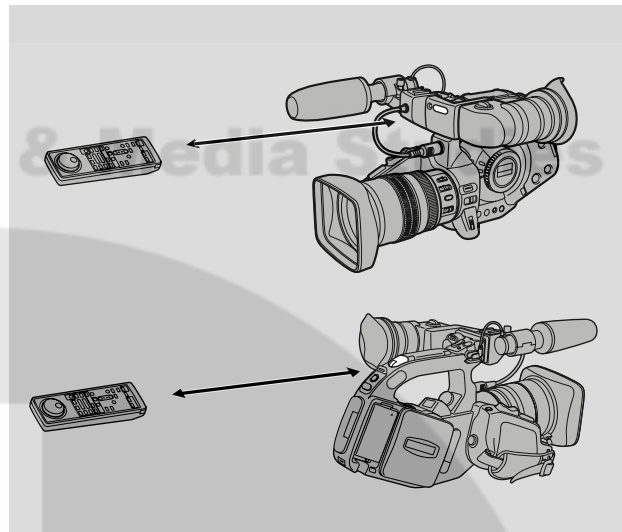

Inserting batteries

Insert two AAA batteries, following the ⊕ and ⊖ markings. Be careful not to reverse the polarity of the batteries.

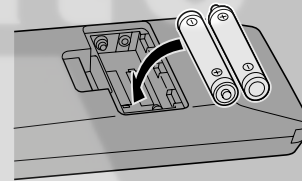

Notes:

- When using the wireless controller in brightly lit places or outdoors, the effective range will be less.
- The camera may have difficulty picking up the remote control signals at extremely close range.
- Do not leave the controller exposed to direct sunlight, or in hot or humid places.
- When the batteries run out, replace them both together.
- Make sure the shoulder strap does not obstruct the tally sensors.

5151 State University Drive Los Angeles, CA
www.calstatela.edu

Turning off the remote sensors

The remote sensors can be turned off to prevent interference from other Canon wireless controllers being used nearby.

MENU

(see p. 27)



1. Open either the camera menu or the VCR menu, and select **SYSTEM**.
2. Select **SENSOR**, then select **OFF** setting.
3. Close the menu.
 - appears in the viewfinder.

Turning off the tally lamps

The tally lamps let you know that the camera is recording. However, the flashing of the front lamp may be reflected into the lens during close-up recording, or when recording through glass.

You may therefore decide to turn them off.

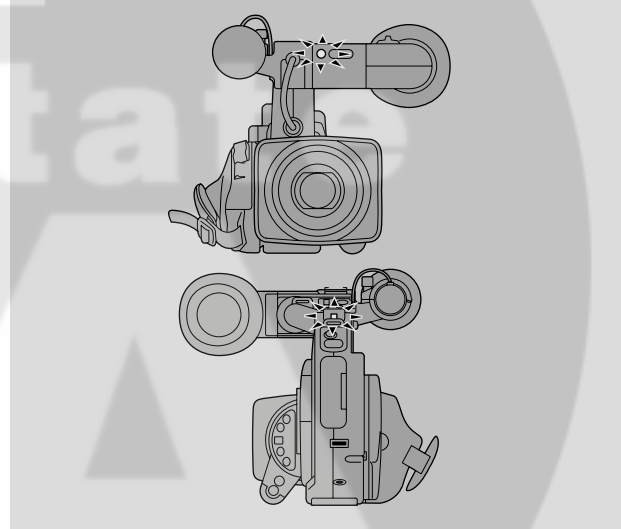

Preparation

MENU

(see p. 27)



1. Open the camera menu and select **SYSTEM**.
2. Select **TALLY LAMP**, then select **OFF** setting.
3. Close the menu.
 - The tally lamps no longer flash during recording, but they will still light up when the camera receives a signal from the wireless controller.

www.calstatela.edu

Setting the Date and Time

E

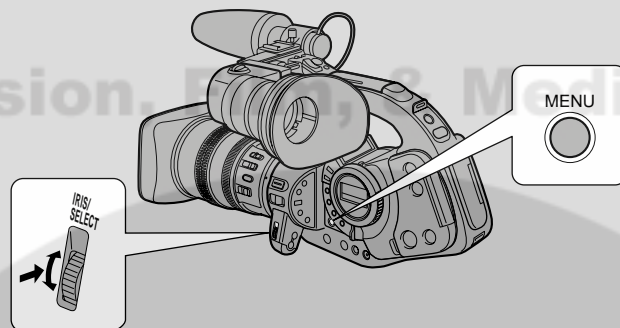

The date and/or time display forms part of the data code. You can choose to display or hide it during playback (see p. 79).

Set the date and time display when you first start using your camera. Install the backup battery before you begin (see p. 99).

- Before you start setting the date and time, select your home time zone from the menu.

Setting the time zone/daylight saving time

MENU

(see p. 27)

▶SYSTEM▶

▶▶ T.ZONE/DST ••▶N.Y. *

1. Open the camera menu and select SYSTEM.

2. Select T.ZONE/DST.

- The time zone display appears in the viewfinder.
- Your camcorder's time zone is factory-preset to New York. If you are at another time zone, select your time zone first and daylight saving time (DST) setting if necessary.

3. Move up or down the list of time zones with the IRIS/SELECT dial.

Select the option that represents your time zone.

- If you are now in daylight saving time, select the time zone with the daylight saving time mark  next to the area.

4. Close the menu.

5151 State University Drive Los Angeles, CA

www.calstatela.edu

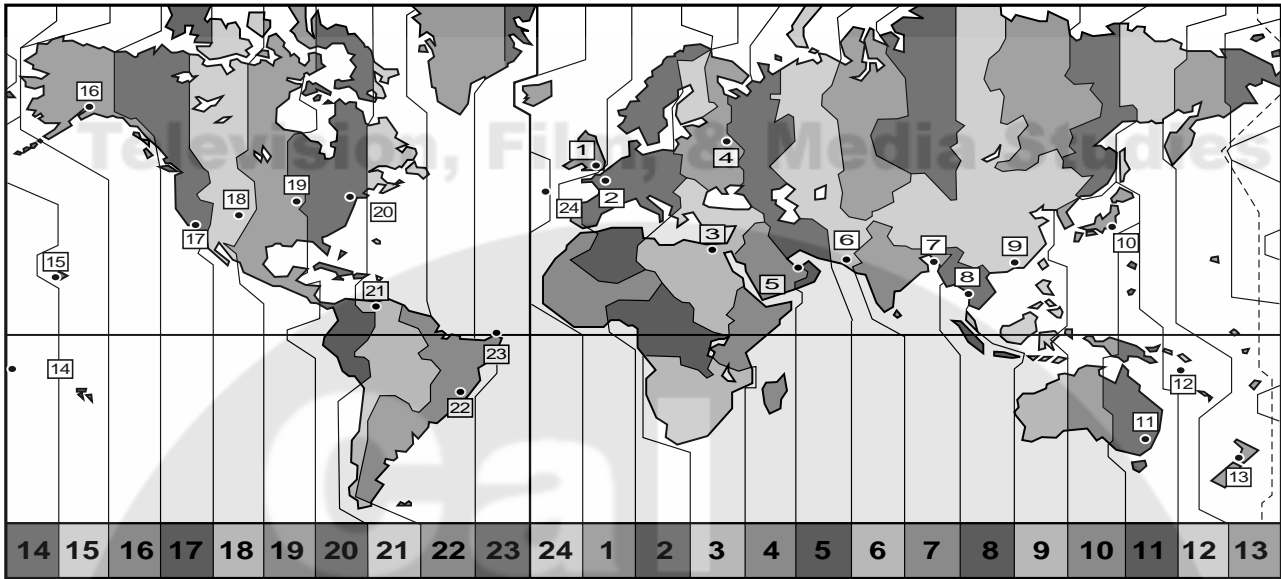

No.	Time zone	No.	Time zone
1	LONDON	13	WELLGTN (Wellington)
2	PARIS	14	SAMOA
3	CAIRO	15	HONOLU (Honolulu)
4	MOSCOW	16	ANCHOR (Anchorage)
5	DUBAI	17	L.A. (Los Angeles)
6	KARACHI	18	DENVER
7	DACCA	19	CHICAGO
8	BANGKOK	20	N.Y. (New York)
9	H. KONG (Hong Kong)	21	CARACAS
10	TOKYO	22	RIO (Rio de Janeiro)
11	SYDNEY	23	FERNAN. (Fernando de Noronha)
12	SOLOMON	24	AZORES

Notes:

- After you have selected your time zone and set the date and time, when you travel to another time zone, there is no need to reset the date and time. Just set the time zone to your destination and the camera's clock will automatically change to display the correct time for your destination.
- The camera automatically accounts for the number of days in a month and leap year.

5151 State University Drive Los Angeles, CA
www.calstatela.edu

Setting the clock

After you set the date and time, the date/time and home time zone will be displayed for about 4 seconds each time you turn the power on.

MENU

(see p. 27)

►SYSTEM►

►► D/TIME SET..►JAN. 1, 2001
12:00 AM

1. Open the camera menu and select **SYSTEM**.
2. Select **D/TIME SET**.
 - The year display starts to flash.
3. Turn the **IRIS/SELECT** dial up and down to change the year. Press the dial in to move to another part of the display.
 - Once you move from the year, the next part of the display starts flashing.
4. Set the month, day, hours, and minutes in the same way.
5. Press the **MENU** button when finished, and to start the clock.

Notes:

- To make a change to part of the date and time, press the **IRIS/SELECT** dial in at step 3 to move to the part to be changed. Turn the dial to make the change, then close the menu.
- The date can be set to any year between 2001 and 2031.
- If you press the **MENU** button in the middle of setting the date and time, you leave the menu, and the clock starts.
- If you press the **IRIS/SELECT** dial in after setting the minutes you can set the date and time again from the start.

Date and time display

You can choose to display or hide the date and time display during recording. When the date and time display is set to **ON**, the date and time show in the lower left-hand corner of the display but the time zone disappears in about 4 seconds. The 4-second display will no longer appear when you turn on the power. It is not automatically superimposed on your recordings.

MENU

(see p. 28)

►DISP.SET UP►

►► D/TIME SEL..►DATE & TIME

To turn it on, open the camera menu and select **DISP.SET UP**. Then select **D/T DISPLAY**, set it to **ON** and close the menu.

5151 State University Drive Los Angeles, CA

www.calstatela.edu

Basic Recording

E

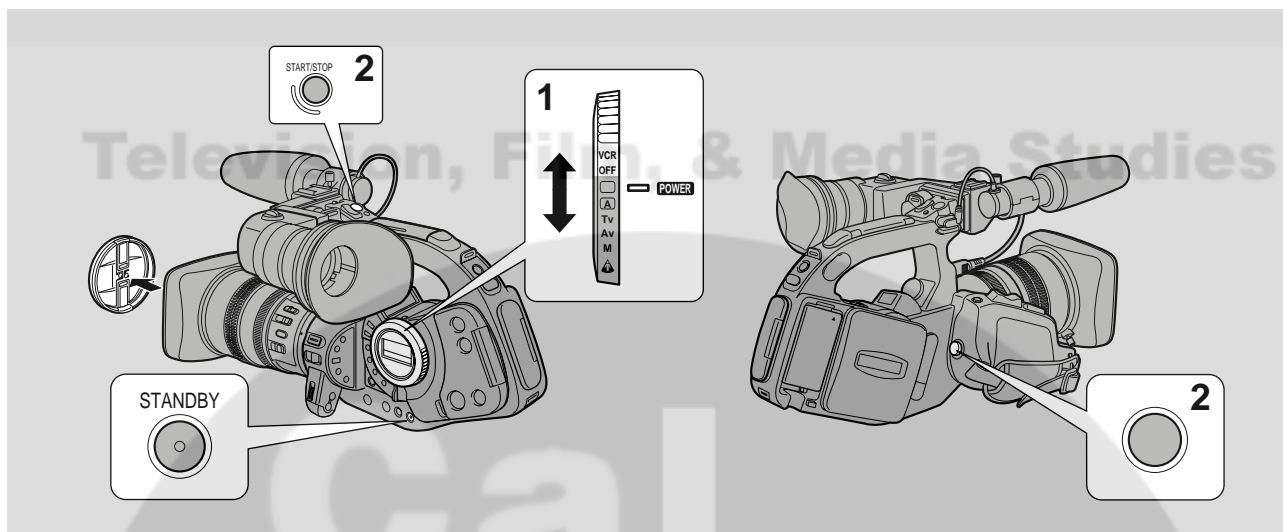

Before you start recording

- Attach a power source (p. 19).
- Load a cassette (p. 22).
- Remove the lens cap and fasten the shoulder pad (p. 24).
- Adjust the viewfinder (p. 16).
- Choose your grip — side or top (p. 24).

You may also want to install the backup battery (p. 79) in order to set the date and time display (p. 79).

To record

- 1. Turn the POWER dial to .**
 - This selects the camera's Easy Recording program. It allows you to simply point and shoot without making any manual adjustments (see pp. 66-75).
 - The camera power indicator lights up red and PAUSE appears in the viewfinder — the camera is now in "record pause mode".
- 2. Press the start/stop button to begin recording.**
 - There are two start/stop buttons, to give you control from both gripping positions.
 - The tally lamps flash rapidly and REC appears in the viewfinder.
- 3. Press the start/stop button again to pause recording.**
 - The camera returns to record pause mode and PAUSE reappears in the viewfinder.
 - You can stop and restart recording as often as you like by pressing the start/stop button.

Using the STANDBY button

As long as the POWER dial is set to a recording program, you can use the STANDBY button to turn the camera on and off. This makes it easy to save battery power, and prevents accidental operation of the start/stop button.

Press and hold the STANDBY button for a few moments to enter/leave standby mode. When the camera enters standby mode, ENTERING POWER STANDBY is shown in the viewfinder.

Five-minute Auto Shut off

MENU

(see p. 26)

▶ VCR SET UP ▶

▶▶ PWR SAVE.....▶ SHUT OFF

The camera will turn itself off if you leave it in the record pause mode for more than about 5 minutes. You can select this 5-minute timer between power off the whole camera (SHUT OFF) or turn off the recorder section (VCR STOP) from the VCR SET UP submenu of the camera menu.

In VCR STOP mode, as you can operate the camera section, you can adjust iris, shutter speed or etc. without worrying about the 5-minute timer.

To return to record pause mode, press the CSTM KEYS “VCR STOP” button. To start recording, press the start / stop button.

In SHUT OFF mode, press the STANDBY button or set the POWER dial to OFF and then back to recording program.

VCR Stop

MENU

(see p. 27)

▶ CUSTOM KEYS ▶

▶▶ KEY 1.....▶ VCR STOP

The recorder section can be turned off by setting the CSTM KEYS 1 or 2 to VCR STOP under the CUSTOM KEYS submenu in the camera menu.

Press the “VCR STOP” button so that you can alter the camera parameters regardless of the 5-minute timer.

Press the VCR STOP button again to return to record pause mode.

When you have finished recording

- Replace the lens cap.
- Unload the cassette.
- Set the POWER dial to OFF.
- Disconnect the power source.

Notes:

- To check that the camera is recording correctly, make a test recording first.
- Before making important recordings, clean the video heads using a Canon DVM-CL Digital Video Head Cleaning Cassette or a commercially available digital video head cleaning cassette.

5151 State University Drive Los Angeles, CA

www.calstatela.edu

Changing the recording mode (SP/LP)

You can record and play back a tape in SP (standard play) and LP (long play) modes. LP extends tape usage by 1.5 times.

You can't add sound (audio dubbing) or images (AV insert) to a tape that has been recorded in LP mode. If you plan to use either of these functions later, record in SP mode.

MENU

(see p. 26)

▶ VCR SET UP ▶

▶▶ REC MODE...▶SP

To change to LP mode, open either the camera menu or the VCR menu and select VCR SET UP. Then select REC MODE, set it to LP and close the menu.

Notes:

- When recording and playing back tapes in LP mode, the nature of the tape and usage conditions may affect recording, mosaic-like noise may appear in the image and the sound may be distorted during playback. For important recordings, therefore, set the camera to SP mode.
- If you record in both modes on the same tape, the picture may become distorted during playback and the time code may not be written correctly.
- A tape recorded in LP mode on other digital equipment may produce mosaic-like noise and the sound may become distorted when played back on this camcorder, and vice versa.

Turning the camera recording displays ON/OFF

You can change the viewfinder display by pressing the EVF DISPLAY button.

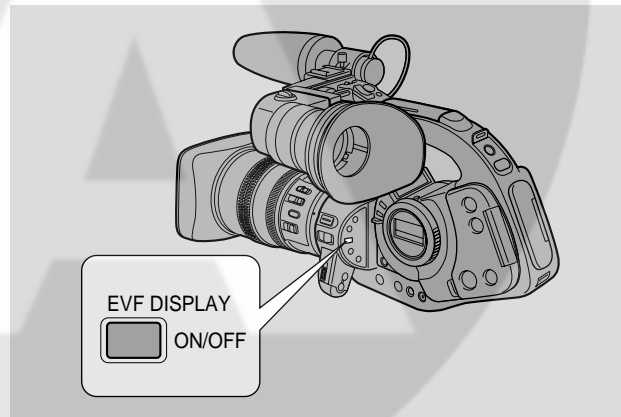
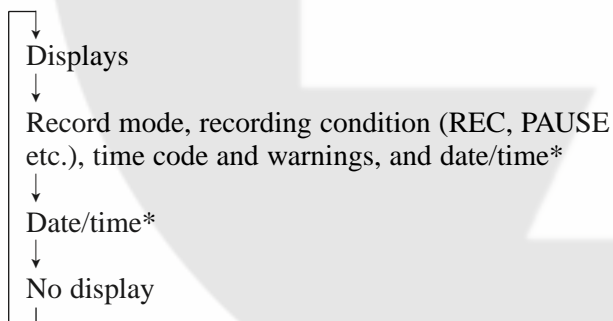

Recording

*Appears when the GUIDE INFO of the DISP. SET UP submenu (Camera menu) is set to D/T DISPLAY.

- When you turn the camera off, it returns to usual display.
- The same information is displayed on the connected TV screen (TV SCREEN function).

Zooming (for Zoom Lenses)

- Refer to the appropriate lens instruction manual. Note that the lens functions vary by the lens type.

E

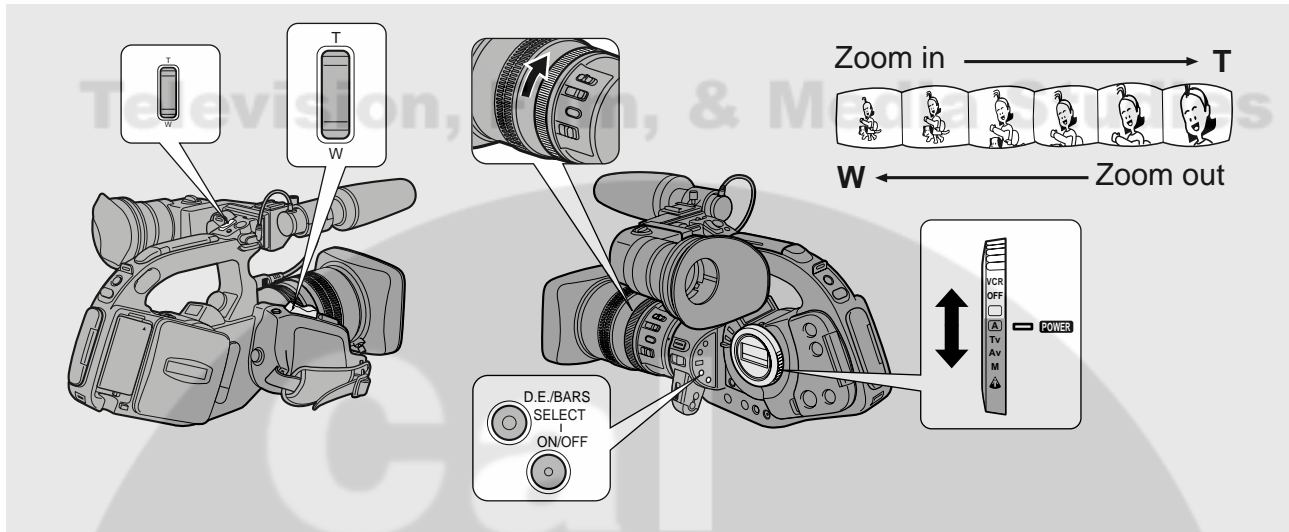

Optical zoom

Operate the zoom controls from either the side grip or the camera handle. Turn the zoom control towards W to zoom out to wide-angle. Turn it towards T to zoom in to telephoto.

You can also zoom in and out using the lens's zoom ring.

To control the speed of zooming (using the zoom control on the side grip and the lens's zoom ring):

- Move the control/ring slightly to zoom slowly.
- Turn it further to zoom more quickly. (The further you turn the zoom control/ring, the faster the zoom speed.)

The T and W buttons on the wireless controller and the camera handle adjust the picture angle, but not the zoom speed.

Notes:

- When the lens is at the extreme wide-angle position, you can focus on a subject as close as 3/4 in (2 cm).
- Since the zoom changes the picture angle, when using the high speed zoom there are cases when the autofocus can not keep pace with the zoom speed.

5151 State University Drive Los Angeles, CA
www.calstatela.edu

2× digital zoom

E

Activate the digital zoom to double the camera's zoom range.

The zoom control continues to work as usual — the camera automatically switches between optical zooming and digital zooming.

- Image resolution is slightly lower when the magnification exceeds the optical zoom range.

Activating the digital zoom

1. Turn the **POWER** dial to any recording program.
2. Press the **D.E./BARS SELECT** button to move through the list of effects in the viewfinder, until you reach **D.ZOOM**.

- The flashing display changes to show which effect you can select.
- The camera only displays selectable effects.

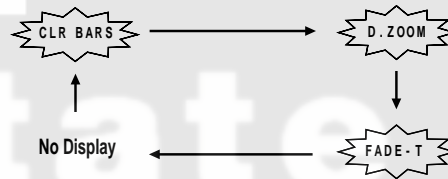

3. Press the **D.E./BARS ON/OFF** button to activate the digital zoom.
 - D.ZOOM is shown constantly in the viewfinder.
4. The digital zoom will remain activated until you press the **D.E./BARS ON/OFF** button to deactivate it. When deactivated, **D.ZOOM** flashes in the viewfinder and you can then press the **D.E./BARS SELECT** button to select a different digital effect, or to turn the digital effects off completely by choosing the blank display.

Notes:

- You cannot select a different digital effect while the digital zoom is still activated.
- The digital zoom remains programmed until you turn it off.

5151 State University Drive Los Angeles, CA
www.calstatela.edu

Recording

Turning the SuperRange Optical Image Stabilizer On/Off (16× IS II lens)

E

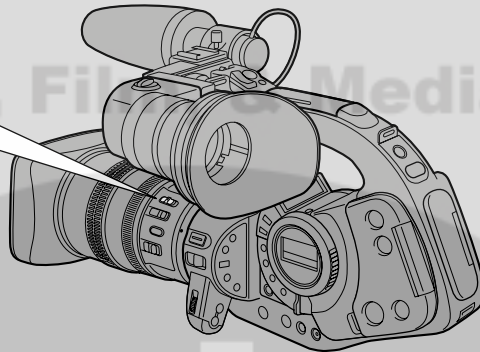
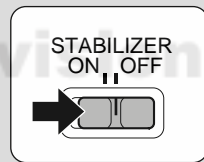

The Optical Image Stabilizer can compensate for a wide range of camera movement — you can record stable images even if you are shooting from a moving car.

Before you start recording, slide the STABILIZER switch on the video lens to turn the image stabilizer on or off.

Notes:

- The image stabilizer is designed to deal with a normal degree of camera shake.
- Keep the image stabilizer turned off when the camera is mounted on a tripod.
- Sliding the switch to OFF has no effect when the camera is set to the Easy Recording program.
- The image stabilizer is not as effective as usual when the Extender XL 1.6× (optional) is attached.

Recording

5151 State University Drive Los Angeles, CA
www.calstatela.edu

Using the ND Filter (for appropriate lenses)

- Refer to the appropriate lens instruction manual. Note that the lens functions vary by the lens type.

E

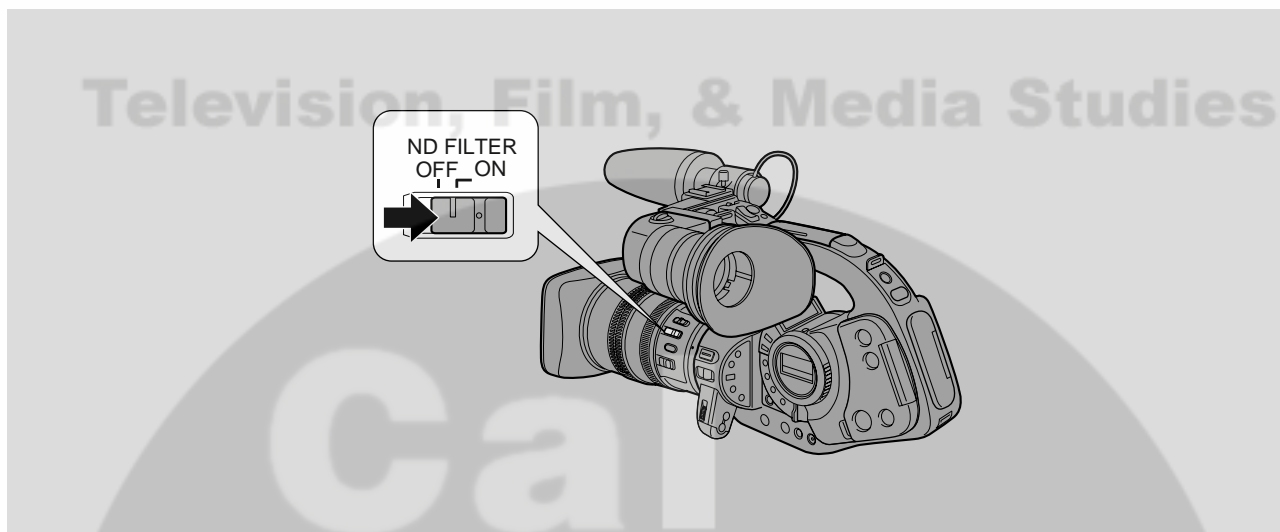

On bright days or when recording very bright scenes, despite the iris being at its smallest aperture, blurring of the image may occur. In such cases, using an ND filter should remove this problem.

The 16× IS II zoom lens XL comes with a built-in ND filter.

The ND FILTER switch is located on the body of the XL lens.

Slide the ND FILTER switch to ON to use the filter.

- ND is shown continuously in the display while the ND filter is switched on.

When the camera is set to the Easy or Auto Recording programs (and the XL lens is attached):

- ND ON flashes in the viewfinder to advise you to switch the ND filter on.
- ND ON with the “ON” flashing advises you to fit an external ND filter* or that the light conditions are still too bright, despite having switched the ND filter on.
- ND OFF with the “OFF” flashing warns you that the ND filter is no longer suitable for the current conditions. Set the ND FILTER switch to OFF.

* When you don't have an external ND filter, make the shutter speed faster in Tv mode or open the aperture in Av mode.

Note:

- Make sure you reset the white balance, if you were using a manual white balance before you turned the ND filter on.

5151 State University Drive Los Angeles, CA
www.calstatela.edu

Taking Still Pictures (Photo Mode)

E

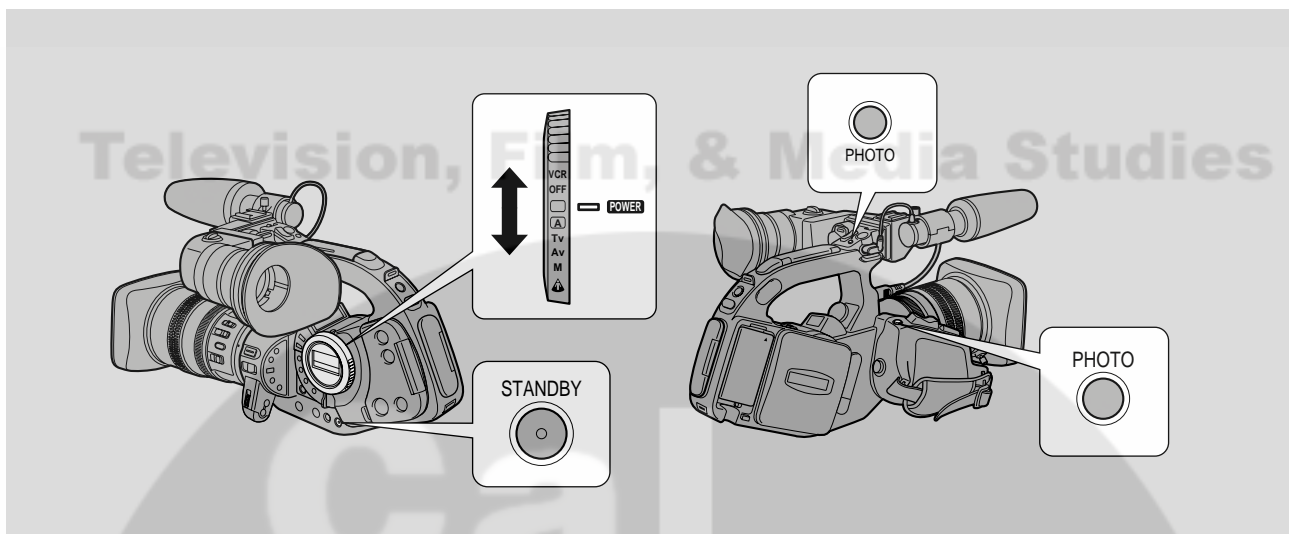

You can record still pictures like a photograph. The camera records the picture and sound to tape for approximately 6 seconds. The exposure is automatically adjusted.

Also, starting your shooting with a still photo makes it easy to find the beginning again later with the Photo Search function (p. 81).

There are 2 Photo buttons on the camera body, to let you take still images from both gripping positions.

You can take a still picture at any time during regular video recording, or you can put the camcorder into record pause mode first, then take a still picture.

During record mode

Press the PHOTO fully down and the still picture will be taken immediately.

- The camera takes the images immediately, and then records the “photo” to the tape for approximately 6 seconds. During this time the camera also records the sound, and the display shows the still picture.
- A counter display appears, and counts up to 6 seconds as the camcorder records the picture.
- The camera returns to record pause mode.

During record pause mode

1. Press the Photo button halfway down and hold it:

- “PHOTO” flashes in the viewfinder.
- Exposure is locked.
- During autofocus ● flashes white in the viewfinder as the camcorder adjusts the focus and it is displayed continuously as a green mark when the camera is ready to take the still picture. (The focus, exposure and zoom are now locked. Also you cannot turn the image stabilizer on/off)
- To change the still picture before recording: release the button, select a new picture and then press down the PHOTO button lightly once more.
- If the subject is unsuitable for autofocus (p. 108), the camera may not be able to focus, and ● may continue to flash white in the viewfinder. In this case: override the focus temporarily using the lens’ manual focusing ring (p. 66). The green mark lights up.
- If you are recording using manual focus (p. 66), the ● mark will light up green when you first press the PHOTO button. Focus the camera using the manual focusing ring.

2. Press the PHOTO button fully down to take the still picture.

- The camera takes the image immediately, and then records the “photo” to the tape for approximately 6 seconds. During this time the camera also records the sound, and the display shows the still picture.
- A counter display appears, and counts up to 6 seconds as the camera records the picture. ● disappears from the display.
- The camera returns to record pause mode.

Notes:

- While the camera records the still, you cannot use the camera functions (POWER dial/STANDBY button do not respond until recording is complete). This applies even when you haven’t loaded a cassette.
- The wireless controller’s PHOTO button has no half-way setting, press the button and the camera soon takes the “photo”.
- Only take “photos” where it is bright enough to see the image in the viewfinder.
- For even greater versatility, attach a Canon Speedlite for flash photography (available as optional accessories, see page 60), when taking still pictures from record pause mode.

Choosing the Movie Mode (Normal/Frame)

E

The Frame mode can be used when you want to look at a video, scene by scene, free from field slippage (the “flicker” that normally occurs when you pause a video). The vertical resolution of the image is improved by 1.5×. During playback, pause the video at any time if you would like to view a crystal clear still image in the display or on a connected TV screen. It is also possible to transfer your favorite still pictures to a PC for image enhancement and print out. Since the frame rate is close to that of a movie, this mode can be used to create “cinematic-like appearance.”

MENU

(see p. 26)



1. Turn the **POWER** dial to any recording program except Easy Recording.
2. Open the camera menu and select **CAM. SET UP**.
3. Select **MOVIE MODE**, then select **FRAME** setting.
4. Close the menu.
 - FRAME appears in the viewfinder.

Notes:

- To return to normal video shooting, you need to re-select **NORMAL** from **MOVIE MODE** at the camera menu.
- Frame mode cannot be used with the Easy Recording program.
- Frame video may not appear completely smooth during normal playback.

5151 State University Drive Los Angeles, CA
www.calstatela.edu

Searching and Reviewing While Recording

Record search

When the camera is in record pause mode, you can use record search to play the tape forwards or backwards to find the point where you want to start or restart recording.

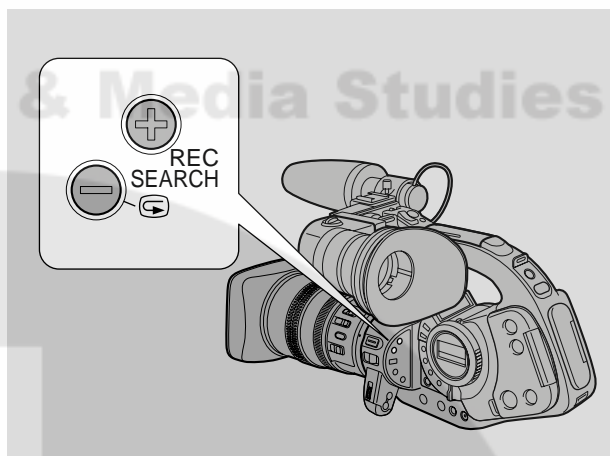

E

1. **Make sure the camera is in record pause mode.**
2. **Press and hold the REC SEARCH + or – button while you check the picture in the viewfinder.**
 - The + button plays the recording forwards and the – button plays it backwards.
3. **Release the button when you find the point where you want to start recording.**
 - The camera returns to record pause mode.

Record review

When the camera is in record pause mode, you can use record review to play back the last few seconds of your recording and then return automatically to record pause mode.

1. **Make sure the camera is in record pause mode.**
2. **Press and release the  (record review) button while you check the picture in the viewfinder.**
 - The camera rewinds the tape, plays back the last few seconds, and returns to record pause mode.

Note:

- Noise may appear on the screen during record search and record review.

Recording

5151 State University Drive Los Angeles, CA
www.calstatela.edu

Using the Various Recording Programs

E

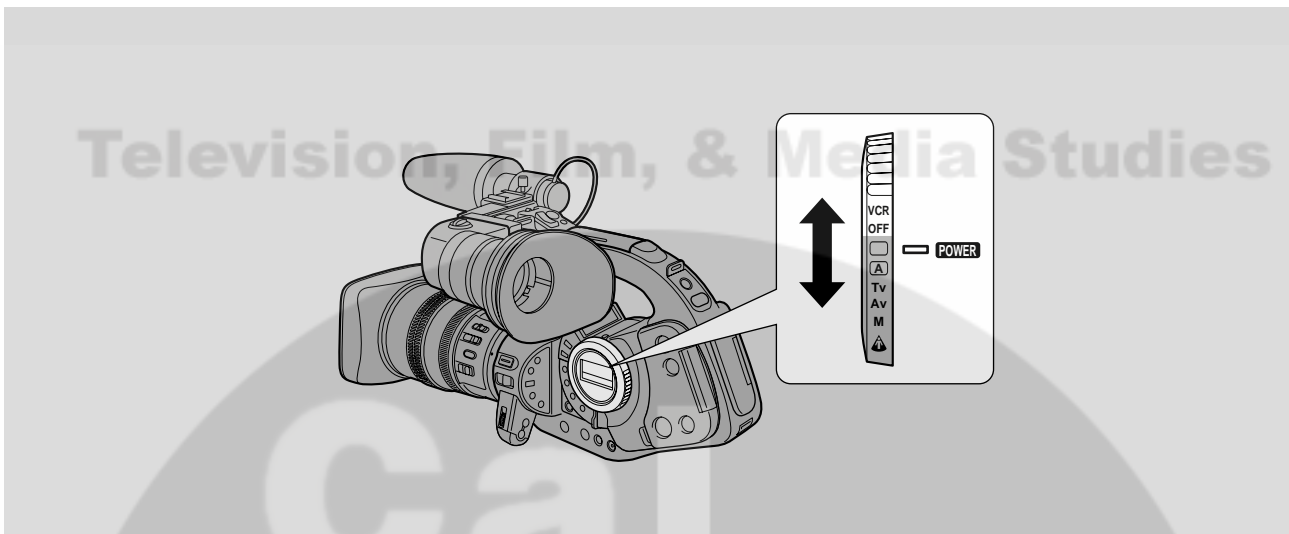

The camera provides you with a choice of 6 recording programs. They use different combinations of camera settings in order to adjust the exposure and other functions to match the recording situation.

The name of your selected recording program appears constantly on the left of the display, with the exception of the Easy Recording program whose mark is displayed and then disappears after 4 seconds.

Notes:

- Avoid changing programs during recording as the brightness of the image may change suddenly.
- The specialized AE programs are not suitable for all kinds of lighting. The image may flicker, or a bright line may appear on the screen if you use them in the wrong lighting conditions.

Recording

5151 State University Drive Los Angeles, CA
www.calstatela.edu

Availability of functions in each recording program.

Recording programs	<input type="checkbox"/> (Easy Recording)	Auto	Tv	Av	Manual	Spotlight	During Exposure LOCK
EXP LOCK button	×		○		×	×	—
IRIS/SELECT dial	×	× *1	○ *1	○	○	×	○
SHUTTER button	×	× *1	○	× *1	○	×	○
AE LEVEL dial	× (fixed at 0)		○		×	×	×
GAIN knob	× (fixed at auto)		○			×	○
WHITE BALANCE dial	× (fixed at auto)			○			
WHITE BALANCE set button	×			○			
Color, Sharpness, Setup Level adjustment	○			○			
CSTM PRESET SELECT button	×			○			
CSTM PRESET ON/OFF button	×			○			
CSTM KEYS1 button	○			○			
CSTM KEYS2 button	○			○			
Movie mode	× (fixed at normal)			○			
16:9	× (fixed at off)			○			
Frequency selection of Clear Scan	×	×	○ *2	×	○ *2	×	○ *2
Clear Scan	×	×	○	×	○	×	× *3
Colour Bars				○			
Digital zoom				○			
Fade trigger	×			○			

○: Available ×: Not available

*1: Available when the Exposure is locked.

*2: Available during the Clear Scan.

*3: The SHUTTER buttons have no effect you lock the exposure during Clear Scan operation in Tv mode.

E

Available functions in recording programs vary by the lens type.

16× IS II, 16× IS lens and 3× wide lens

Recording program	<input type="checkbox"/> (Easy Recording)	Except <input type="checkbox"/> (Easy Recording)
Manual focus ring		○
Zoom ring		○
Image Stabilizer *1	× (fixed at on)	○
ND filter		○
Focus mode	× (fixed at autofocus)	○
Push AF button	×	○

*1: 16× IS II / 16× IS lens only

16× manual lens

Recording program	<input type="checkbox"/> (Easy Recording)	Except <input type="checkbox"/> (Easy Recording)
Zoom ring		○
ND filter		○
Zoom speed	×	○

Easy Recording

The simplest way to use the camera is with the POWER dial set to the  position. The camera will take care of focus, exposure and other adjustments, leaving you free to point and shoot.



E

Auto

In normal recording conditions, set the POWER dial to  (Auto). This is the same as the Easy Recording program, except that you now have the option of using any of the camera's manual functions — you can adjust focus and exposure, set the white balance, and so on.



Manual

Select this program for total creative freedom when operating the camcorder. You can set aperture and shutter speeds completely independently to give you exactly the exposure you require.

M

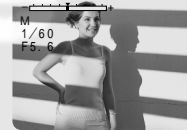

There are 27 shutter speed settings, between 1/8 and 1/15000 of a second and 28 aperture values, between f/1.6 and f/16 (you can also close the iris.)

Spotlight

The exposure is automatically adjusted for glare-free recordings of subjects lit by a concentrated light source.



Recording

5151 State University Drive Los Angeles, CA
www.calstatela.edu

Giving priority to shutter speed (shutter-priority: Tv)

Use this program to let you select the shutter speed.

The camera sets the appropriate aperture (F number) automatically to give the correct exposure.

When you turn the POWER dial to Tv, the current shutter speed is shown in the viewfinder. Select your desired shutter speed by pressing the SHUTTER ▲ and ▼ buttons.



Tv

You can choose 12 shutter speeds between 1/8 and 1/15,000 of a second and also CS (Clear Scan) mode.

- If you try to set a shutter speed that is either too high or too low for the shooting conditions, the indicator flashes in the viewfinder. In this case, increase or decrease the setting until the flashing stops, or slide the ND FILTER switch ON/OFF as appropriate before changing the setting.

Note:

- When recording in extreme low-light conditions, we recommend the use of a Canon Speedlite or Video Light (available as optional accessories, see page 60).

Giving priority to the aperture (aperture-priority: Av)

Use this program to let you select the aperture (iris diameter) to give you maximum control over the depth of field.

A large F number (a small aperture) gives a greater depth of field.



Av

- Under very bright conditions when you have set the F number to f/16, blurring of the image may occur. Check the image in the viewfinder while setting the aperture.
- When a lens that has a built-in ND filter is attached, if you switch the filter on, the intensity of the light is reduced and the image in the viewfinder may go dark. In such a case, switch the filter off and change the aperture setting.
- When shooting in the (Easy Recording) or (Auto) programs on bright sunny days outdoors, the camera may display “ND ON”/“ND OFF” repeatedly. In this case, it may be effective to switch to the Av recording program and adjust the setting of the F number to between f/5.6 and f/11 (the shutter speed may become higher than usual).

The camera sets the appropriate shutter speed automatically to give the correct exposure. When you turn the POWER dial to Av the current F number is shown in the viewfinder. Select your desired F number by turning the IRIS/SELECT dial.

You can choose 8 F numbers between f/1.6 and f/16, and CLOSE to shut the iris completely. If you try to set an F number that is too high or too low for the shooting conditions, the indicator flashes in the viewfinder. In this case, increase or decrease the setting until the flashing stops.

Note:

- The camera memorizes the latest Tv or Av value until a new value is set except when you change the exposure after locking the exposure.
Turning off the camcorder or changing the recording program does not erase the stored value.

Selecting the Audio Mode

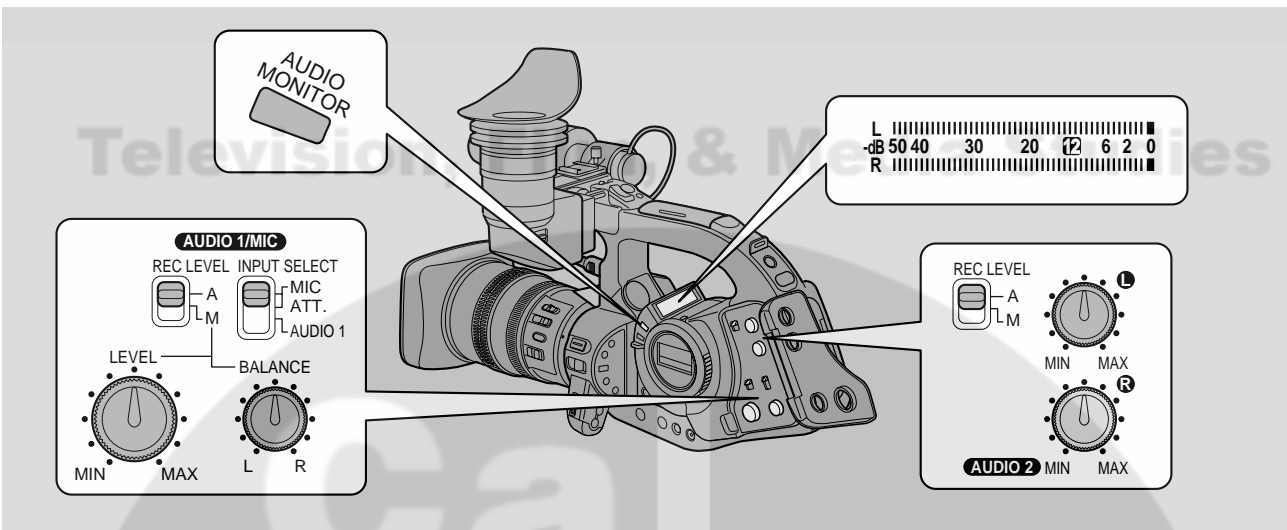

The XL1S can record sound in 3 audio modes:

- 16-bit (48kHz, 2 channel) for the highest sound quality
- 12-bit ST-1 (32kHz, 2 from 4 channels) for recording on two channels (stereo 1), leaving two channels (stereo 2) free for you to add new sound at a later date.
- 12-bit ST-1, 2 (32kHz, 4 channels) for simultaneous recording on four channels (stereo 1 and stereo 2).

MENU

(see p. 26)

▶ VCR SET UP ▶

▶▶ AUDIO MODE ▶▶ 16 bit

1. To switch between the 3 modes, open the camera menu and select **VCR SET UP**.
2. Select **AUDIO MODE**, then select a mode.
3. Close the menu.
 - The name of your chosen mode is displayed in the viewfinder and main LCD panel.

After selecting the audio mode you can set the audio input:

- The settings for 16-bit and 12-bit stereo 1 audio are the same, and are explained under “Two Channel Recording” on the next page.
- The settings for 12-bit stereo 1, 2 are explained under “Four channel Recording” on page 53.

Note:

- For audio output details, including how to play back a tape that has new sound on stereo 2, see page 96.

5151 State University Drive Los Angeles, CA
www.calstatela.edu

E

Recording

Setting the Audio Input — Two Channel Recording

Set the input for Stereo 1 in one of two ways, A or B, depending on the source for the input:

E

A. Using the supplied microphone or attaching an external microphone to the mini jacks

1. Change the audio mode at the menu if necessary (see page 26).
2. Slide the **INPUT SELECT** switch to **MIC**.
 - This assigns the MIC mini jacks as the source for the audio input.
 - In place of the supplied microphone, you can attach an external microphone to the mini jacks.
 - If you wish to use the attenuator to provide more natural sound without distortion (when recording in loud places) slide the INPUT SELECT switch to ATT.

B. Using the AUDIO 1 RCA jacks

1. Change the audio mode at the menu if necessary (see page 26).
2. Slide the **INPUT SELECT** switch to **AUDIO 1**.
 - This assigns the AUDIO 1 RCA jacks as the source for the audio input.

MENU

(see p. 26)

▶ VCR SET UP ▶

▶▶ AUDIO 1 IN ◦▶ LINE

3. Open the camera menu and select **VCR SET UP**.
4. Select **AUDIO 1 IN**, then select a mode.
 - LINE: To record sound from a VCR, CD or other line in devices.
 - MIC ATT20: To record sound using a microphone, when the sound level is high.
 - MIC: To record sound using a microphone (e.g. attached via the optional MA-100 or MA-200 Microphone Adapter/Shoulder Pad).
5. Close the menu.

Setting the recording level for 2 channel recording

In normal recording conditions, the camera sets the audio recording level automatically, as long as you slide the REC LEVEL switch to A.

You can also set the recording level manually:

1. Slide the **REC LEVEL** switch of the **AUDIO 1/MIC** controls to **M**.
 - MANU appears in the audio LCD panel.
2. Turn the **LEVEL** dial to adjust the recording level and **BALANCE** dial to adjust the balance between the two inputs.
 - Check the levels for each channel in the audio LCD panel.
 - If the level exceeds the Ⓢ point, it is essential for you to monitor the sound using headphones.
 - Adjust the headphone volume by rotating the PHONES LEVEL dial.



Setting the Audio Input — 4 Channel Recording

E

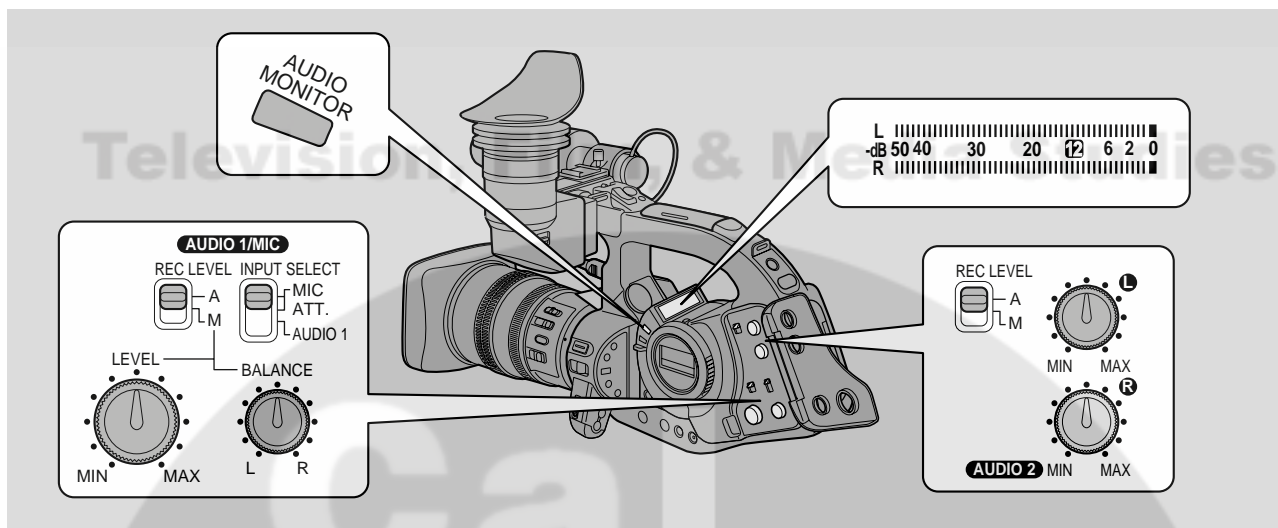

1. Set the audio mode to “12 bit ST-1, 2”.
2. Set the input for stereo 1 in exactly the same way as for 2 channel recording.

MENU

(see p. 26)



3. Set the input for stereo 2 by connecting a device to the AUDIO 2 RCA jacks and then selecting the appropriate option for AUDIO 2 IN:
 - LINE: To record sound from a VCR, CD or other line in devices.
 - MIC ATT20: To record sound using a microphone, when the sound level is high.
 - MIC: To record sound using a microphone (e.g. attached via the optional MA-100 or MA-200 Microphone Adapter/Shoulder Pad).

Setting the recording level for 4 channel recording

In normal recording conditions, the camera sets the audio recording level automatically as long as you slide the REC LEVEL switch to A (automatic).

You can also set the recording level manually:

1. Set the recording level for stereo 1 in exactly the same way as for 2 channel recording.
2. Set the recording level for stereo 2 by sliding the REC LEVEL switch of the AUDIO 2 controls to M (manual).
3. Turn the L and R dials to independently adjust the recording levels of the 2 inputs (corresponding to the L and R channels of the AUDIO 2 RCA jacks).
 - Check the levels for each channel in the audio LCD panel.
 - It is essential for you to monitor the sound using headphones.
 - Adjust the headphone volume by rotating the PHONES LEVEL dial.

Making a Sound Check

E

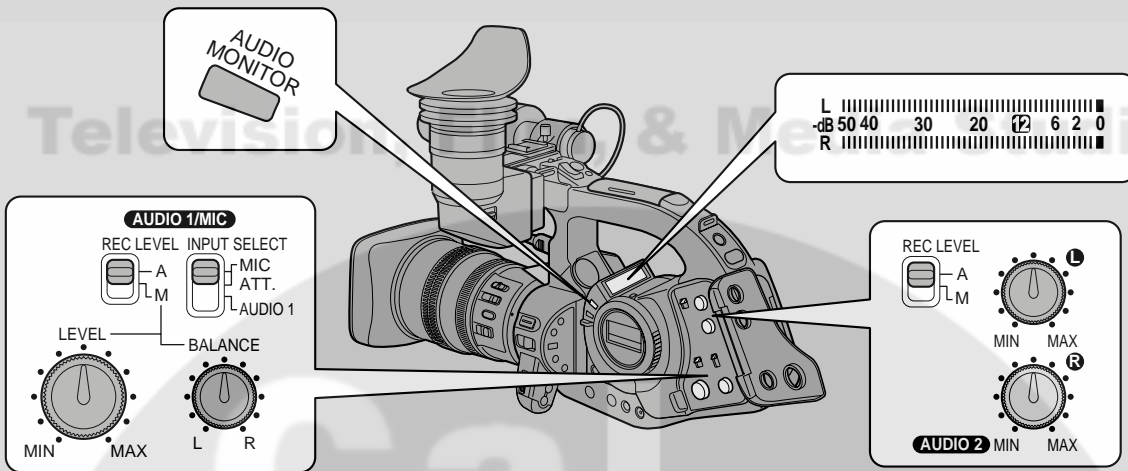

Press the AUDIO MONITOR button to make a sound check — stereo 1 only (ST1), stereo 2 only (ST2) or both (MIX) [each in turn].

- Your choice is selected a few seconds after you last pressed the button, and shown in the viewfinder and audio LCD panel.
- Unlike selecting the audio output in VCR mode, you cannot mix the balance at this point — even if VARIABLE is chosen at the VCR menu, it is fixed during camera mode.

Headphones

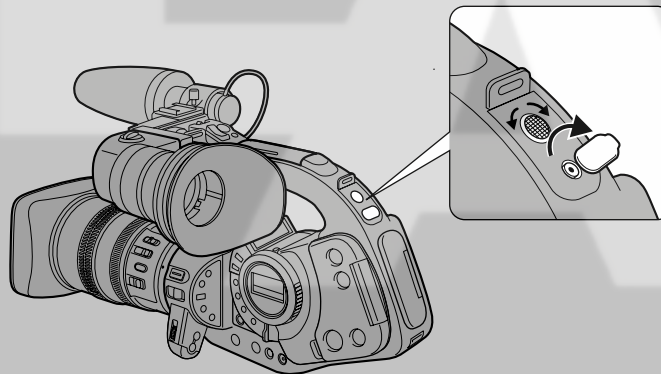

You can monitor the sound while recording by attaching stereo headphones to the camera's Ω terminal. Adjust the headphone volume by rotating the PHONES LEVEL dial.

Using the Custom Keys

You can assign frequently used functions to the custom keys (for camera mode and VCR mode independently). This allows you to customize the camera to your recording situations.

Default settings:

	Camera mode	VCR mode
CSTM KEYS1	INDEX WRITE	TV SCREEN
CSTM KEYS2	ZEBRA	DATA CODE

To view the current custom key setting in the viewfinder, select CUSTOM KEYS from DISP. SET UP in the camera menu or VCR menu.

Functions listed below can be assigned to custom keys.

* Functions with an asterisk can be operated only by the custom key.

* The assignable functions are the same for custom keys 1 and 2.

Camera mode

Index write*
Zebra pattern
VCR stop*
TV screen
Audio 1 in
Audio 2 in
Grip zoom speed
Handle zoom speed
No function assigned

VCR mode

TV screen
Data code
Audio 1 in
Audio 2 in
No function assigned

Changing the custom keys setting

MENU

(see p. 27)

▶CUSTOM KEYS▶

▶KEY 1.....▶INDEX WRITE

1. Open either the camera menu or the VCR menu and select CUSTOM KEYS.
2. Select KEY 1 or KEY2, then select the function.
3. Close the menu.

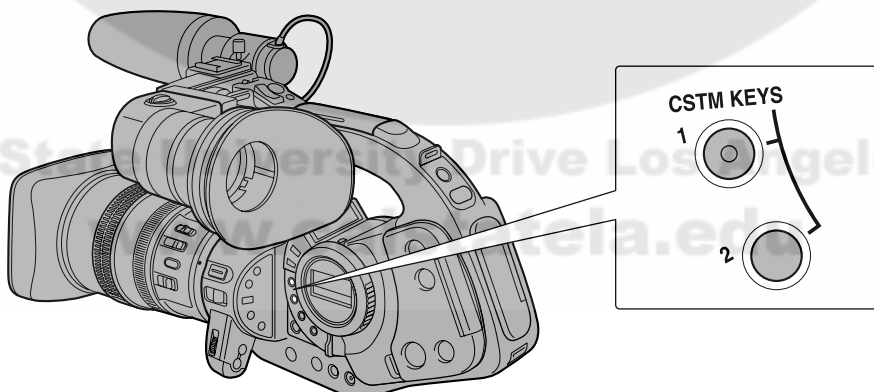

Operating the CSTM KEY button

- A function assigned to a custom key is used as a button of that effect (e.g. “INDEX WRITE” button).

Index Write

CAMERA MODE

You can add an index signal to your recording for easy search in VCR mode.

- You cannot add or erase the index signal later.
- You cannot use “INDEX WRITE” button during photo nor interval timer recording.
- Index Write can be operated only by the custom key.

• While in record mode

Press the “INDEX WRITE” button and the index signal will be recorded for approximately 6 seconds. During this time, “INDEX” appears in the viewfinder.

• While in record pause mode

1. Press the “INDEX WRITE” button and “INDEX” will appear in the viewfinder.

2. Press the start/stop button to begin recording.

- The index signal will be recorded for approximately 6 seconds. During this time, “INDEX” appears in the viewfinder.

Zebra pattern

CAMERA MODE

The zebra pattern is a series of diagonal stripes that appear in the viewfinder to highlight areas of overexposure. Use a guide to setting the aperture (iris) and shutter speed.

This function can also be selected from CAM. SET UP in the camera menu (ZEBRA). The zebra pattern level can be adjusted in the same submenu (ZEBRA LEVEL)(p. 26).

Press the “ZEBRA” button to display the zebra pattern. Press the button again to eliminate the pattern.

- The camera does not record the zebra pattern. It only appears in the viewfinder.

VCR stop

CAMERA MODE

You can turn the recorder section off and leave the camera section turned on. This allows you to adjust the camera regardless of the 5-minute timer.

- VCR STOP can be operated only by the custom key.

Press the “VCR STOP” button to turn the recorder section off. Press the button again to return to record pause mode.

Audio 1 input level

CAMERA MODE

VCR MODE

Press the “AUDIO 1 IN” button to display the Audio 1 input level select menu.

MENU

(see p. 26)

AUDIO 1 IN •▶LINE

- 1. Select the input level from MIC, MIC ATT 20 (mic level with attenuator 20dB), LINE.**
- 2. Close the menu by pressing the IRIS/SELECT dial.**

Audio 2 input levelCAMERA
MODEVCR
MODE

Press the “AUDIO 2 IN” button to display the Audio 2 input level select menu. The “AUDIO 2 IN” button operates the same way as the “AUDIO 1 IN” button.

MENU

(see p. 26)

AUDIO 2 IN ••▶LINE

Grip zoom speedCAMERA
MODE

Press the “ZOOM GRIP” button to display the grip zoom speed select menu.

1. Select the zoom speed from **VARIABLE**, **LOW**, **MEDIUM** and **FAST**.
2. Close the menu by pressing the **IRIS/SELECT** dial.

MENU

(see p. 26)

ZOOM GRIP •••▶VARIABLE

Handle-top zoom speedCAMERA
MODE

Press the “ZOOM HANDLE” button to display the handle-top zoom speed select menu.

1. Select the zoom speed from **LOW**, **MEDIUM** and **FAST**.
2. Close the menu by pressing the **IRIS/SELECT** dial.

MENU

(see p. 26)

ZOOM HANDLE •▶MEDIUM

Data codeVCR
MODE

Press the “DATA CODE” button once to display the data code. Press the button again to hide the data code.

5151 State University Drive Los Angeles, CA
www.calstatela.edu

Fading In and Out Between Scenes

E

Fade trigger

When you start recording, the scene gradually fades in from a black screen. When you stop recording, it gradually fades out.

Set the fade trigger each time you wish to use it (both before you fade in and again before you fade out).

FADE-T is shown constantly in the viewfinder when it is ready for use.

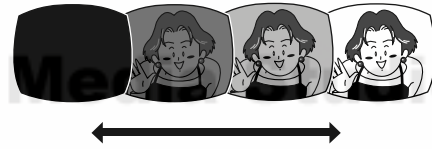

Activating the fade trigger

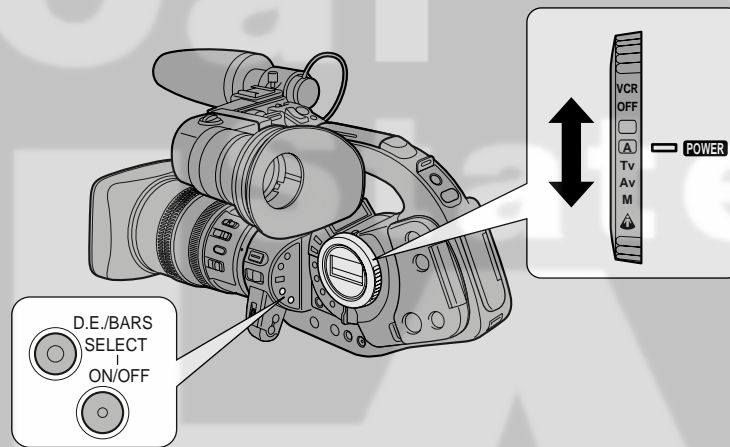

1. Turn the **POWER** dial to any recording program (except Easy Recording).

2. Press the **D.E./BARS SELECT** button to move through the list of effects in the viewfinder, until you reach **FADE-T**.

- The flashing display changes to show which effect you can select.

3. Press the **D.E./BARS ON/OFF** button to set the fade trigger ready for use.

- FADE-T is shown constantly in the viewfinder.

4. Start or stop recording.

- The fade trigger is now activated — the scene will fade in or out.
- FADE-T then starts to flash again in the viewfinder.
- If you wish to use the fade trigger again, press the D.E./BARS ON/OFF button. If not, you can press the D.E./BARS SELECT button to select a different digital effect, or to turn the digital effects off completely by choosing the blank display.

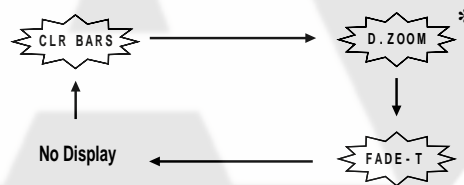

* "D. ZOOM" may not appear according to the lens you use.

Notes:

- You cannot select a different digital effect while the fade trigger is still turned on.
- You can turn the fade trigger off before you use it by pressing the D.E./BARS ON/OFF button again.
- You are unable to use the fade trigger with the Easy Recording program.
- The fade trigger setting is remembered by the camera, until you change the POWER dial setting.

16:9 (Wide screen TV recording)

Produces images in the 16:9 format for playback on widescreen TVs.

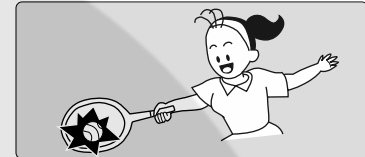
**MENU**

(see p. 26)

▶CAM. SET UP



16:9.....▶OFF

To switch 16:9 to ON, open the camera menu and select CAM.SET UP. Then select 16:9, set it to ON and close the menu.

You can display the guide lines in the viewfinder showing the area you can record when the 16:9 is turned on.

MENU

(see p. 26)

▶DISP. SET UP▶



16:9 GUIDES▶ OFF

To switch 16:9 guide line to ON, open the camera menu and select DISP. SET UP. Then select 16:9 GUIDES, set it to ON and close the menu.

Notes:

- “16:9” is shown in the viewfinder when you switch the 16:9 mode on.
- You cannot use the 16:9 mode with the Easy Recording program.
- If you play back a recording made for 16:9 on a normal TV screen, the image will appear to be vertically “squashed” (compressed).
- If you connect the camcorder to a TV with an S1 terminal or the Video ID-1 system, recordings made in the 16:9 mode for wide screen TVs will automatically play back in wide screen mode on the TV screen.

5151 State University Drive Los Angeles, CA

www.calstatela.edu

Using a Canon Speedlite for Flash Photography (optional)

E

For SLR-style flash photography, attach a Canon Speedlite 420EX or 550EX* to the camera using the optional FA-200 Flash Adapter. Attach its hot shoe cube to the XL1S's accessory shoe, and the flash cable to the flash adapter terminal.

Use the camera in exactly the same way as you would normally in photo mode (p. 42). Turn on the Speedlite using its main switch, and wait for it to charge. When you press the PHOTO button halfway down, the camera sets the autofocus and the zoom is locked. Pressing the PHOTO button fully down releases a pre-exposure flash that sets the flash intensity, exposure and white balance. The main flash is then sent out.

- In dark recording situations, a supplementary light beam is sent out by the flash for approx. seven seconds to illuminate the subject, while you hold the camera's PHOTO button halfway down. This supplementary light only operates during autofocus.

* Speedlite 380EX also can be used.

Flash Charging

While the flash is charging, a white ⚡ flashes in the viewfinder.

When the flash is fully charged a green ⚡ lights up constantly in the viewfinder.

- Although it is possible to record a still image while the Speedlite is still charging, the flash will not go off. In addition, the Speedlite cannot charge while you are holding the PHOTO button halfway down.
- ⚡ disappears from the display while the camera records the still picture.
- If the ⚡ mark does not appear in the viewfinder when you turn the flash on, make sure that the flash unit is slid fully locked on the hot shoe cube.

Notes:

- For full details of how to use the Speedlite, refer to its instruction manual.
- If you use the Speedlite in the shutter-priority (Tv), you can choose any shutter speed between 1/60 and 1/1000 and also CS (Clear Scan) mode.
- In the aperture-priority (Av), you can choose any F number, but an F number of less than f/8 gives the best results.
- You cannot use the Speedlite with the:
 - Manual recording program.
 - Exposure Lock. (⚡ goes out if you press the EXP. LOCK button. It reappears when you turn the lock off, by pressing the EXP. LOCK button.)
- Turn the Speedlite unit off when you do not require the flash.
- The Speedlite can not be used with an SA-1 Adapter Bracket.
- You cannot use the bounce flash on the 420EX and 550EX Speedlite with the XL1S.
- You cannot use the Speedlite Transmitter ST-E2 for the 420EX/550EX.
- You cannot use the 420EX/550EX's multiple speedlite control.
- The FA-200 Flash Adapter contains a special cable. Do not use other cables to attach a flash unit.
- You cannot use a flash with an EF lens nor 14× full manual lens attached to the XL1S.

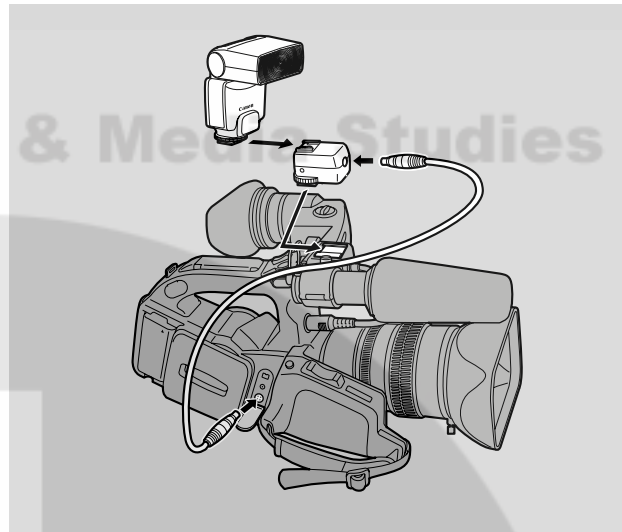

Using the Color Bars

The XL1S is able to record industry standard SMPTE color bars.

E

Activating the color bars

1. Turn the **POWER** dial to any recording program.
2. Press the **D.E./BARS SELECT** button to move through the list of effects in the viewfinder, until you reach **CLR BARS**.
 - The flashing display changes to show which effect you can select.
 - The camera only displays selectable effects.
3. Press the **D.E./BARS ON/OFF** button to activate the **CLR BARS**.
 - CLR BARS is shown constantly in the viewfinder.
4. The color bars will remain activated until you press the **D.E./BARS ON/OFF** button to deactivate it. When deactivated, **CLR BARS** flashes in the viewfinder and you can then press the **D.E./BARS SELECT** button to select a different digital effect, or to turn the digital effects off completely by choosing the blank display.

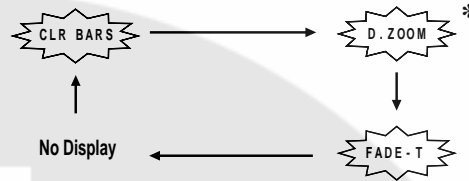

Note:

- You cannot select a different digital effect while the color bars are still activated.

* "D. ZOOM" may not appear depending on the lens you use.

5151 State University Drive Los Angeles, CA
www.calstatela.edu

Recording the Viewfinder Information

E

You can record the information (such as date and time) displayed in the viewfinder superimposed within the picture.

Unlike the data code, you cannot hide the viewfinder information at a later time.

MENU

(see p. 27)

▶ SYSTEM ▶

▶ CHAR. REC...▶OFF

1. Open the camera menu and select **SYSTEM**.
2. Select **CHAR. REC**, then select **ON** setting.
3. Close the menu.

Note:

- Once you set **ON** setting, the information in the viewfinder will remain recorded within the picture until you select **OFF** setting. Note you cannot hide the viewfinder information at a later time.

For instructional use only

Recording

For instructional use only

5151 State University Drive Los Angeles, CA
www.calstatela.edu

Recording with the Interval Timer

With the interval timer, you can record images over a selected time with a selected interval. This function is useful when shooting flowers, animals, and other natural events.

You can choose an interval from 30 seconds, 1 minute, 5 minutes and 10 minutes, and a recording time from 0.5 seconds, 1 second, 1.5 seconds, and 2 seconds.

Example: 2 seconds recording time at a 5 minutes interval
(= standby time of 5 minutes including the recording time of 2 seconds)

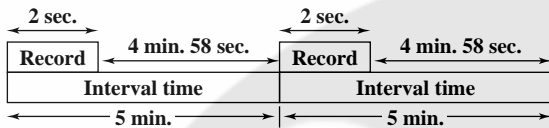

Default setting:

Recording time: 0.5 seconds

Interval time: 30 seconds

MENU

(see p. 26)



1. Open the camera menu and select VCR SET UP.
2. Select INTERVAL, then INTERVAL menu opens.
3. Select ON setting, then select interval time and record time.
4. Close the menu.
5. Press the start/stop button to begin recording.
 - The interval recording starts and INTERVAL appears in the viewfinder.
 - When the interval time is set to 30 seconds or 1 minute, the camera repeats record and record pause and 5 minutes or 10 minutes, the camera repeats record and stop.

To pause interval recording, press the start/stop button.

- The camera returns to record pause and INTERVAL flashes in the viewfinder.
- To restart the recording, press the start/stop button.

To finish interval recording, set the camera in record pause mode, then select OFF in the INTERVAL menu.

- When you record by the interval timer long time (more than 12 hours), we recommend to turn off the viewfinder display by pressing EVF DISPLAY ON/OFF button.
- When the characters displayed remains in the viewfinder, turn off the power and wait few hours.
- The remaining tape display may not appear.

Setting the Self-Timer

E

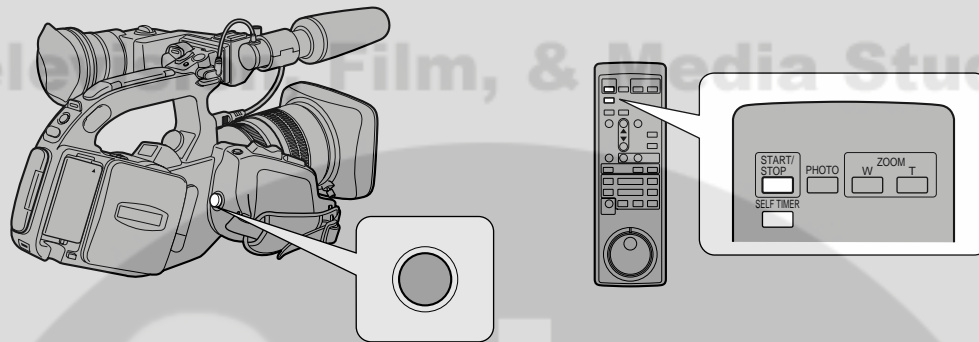

This is useful when you want to include yourself in the picture when recording movies or still photography.

1. Press the wireless controller's **SELF TIMER** button or select **ON** setting of the **SELF T.** from **VCR SET UP** of the camera menu.

- SELF TIMER appears in the viewfinder.

MENU

(see p. 26)

► VCR SET UP ►

► SELF T. ► ON

For movies

2. Press the start/stop button.

- When you press the **START/STOP** button of the wireless controller, the camera starts shooting at the count of 2 seconds (or after 10 seconds on the camera). The remaining time before shooting (e.g. "5 sec") appears in the viewfinder.
- SELF TIMER disappears from the viewfinder when recording begins.

For stills

2. Press a **PHOTO** button.

- When you press the **PHOTO** button of the wireless controller, the camera starts shooting at the count of 2 seconds (or after 10 seconds on the camera).
- The camera automatically adjusts the focus 2 seconds before the countdown is complete. The ● mark flashes white then returns green after the focus and exposure are set. If you are using the wireless controller, the ● mark starts flashing immediately after you press the **PHOTO** button.
- The camera takes the picture for approximately 6 seconds.

Notes:

- Initially the tally lamps flash once a second, then just before recording starts they flash more quickly for a few seconds before the camera starts to record.
- To cancel the self-timer press the **SELF TIMER** button once more before recording. Once the countdown has begun, press the **SELF TIMER**, **START/STOP** or **PHOTO** button to turn it off.
- Cancel the self-timer at any stage by turning the power off or pressing the **STANDBY** button.
- If you press the **SELF TIMER** button when the recording displays have been turned off (p. 37), the self timer display does not appear in the viewfinder, until you press the start/stop/PHOTO button to start the countdown.

Using the DV Control

When equipment such as another camcorder or video recording device, is connected to the XL1S with a DV cable, its record/record pause operation can be controlled by pressing the XL1S' start/stop button.

E

1. Open the camera menu and select **SYSTEM**.
2. Select **DV CONTROL**, then select **ON** setting.
3. Close the menu.

MENU

(see p. 27)



A. When the camera is in record pause mode:

Pressing the start/stop button starts recording on both the XL1S and the connected equipment.

B. When the camera is recording:

Pressing the start/stop button puts both the XL1S and the connected equipment in record pause mode.

C. When the camera does not record (cassette not loaded, etc.):

Pressing the start/stop button puts the connected equipment in record and record pause modes repeatedly.

D. When a cassette is loaded while the connected equipment is recording:

The XL1S first enters record pause mode.

Pressing the start/stop button starts recording on the XL1S and the connected equipment continues recording. Pressing the start/stop button the second time puts both the XL1S and the connected equipment in record pause mode (same as B above).

When the connected equipment is recording, [REC] appears in the viewfinder, if the equipment is in stop, [STOP] appears. When the equipment is not in record, record pause and stop mode, [---] appears, and the "DV controllable" equipment is not connected [DV IF] appears (DV IF flashes)

Notes:

- When both the XL1S and the connected equipment are recording but the XL1S stops recording unexpectedly (end of the tape, etc.), the equipment continues recording.
- When you use 2 XL1S' for DV control, make sure to turn the DV CONTROL off of the "connected equipment".
- Up to 2 video units (total) can be connected for DV control.
- Some equipment may not work correctly.
- DV control setting is memorized even when you turn the power off (by backup battery), be sure to check the setting after you use the DV control as the tape in the connected equipment may be erased.
- Cable length is up to 4.5m.

5151 State University Drive Los Angeles, CA

www.calstatela.edu

Adjusting the Focus (for autofocus lenses)

E

The camera can focus automatically. All you have to do is point it, and whatever is in the center of the display will usually be in sharp focus. If it does not seem to be focusing well, it may be because the subject is not suitable for autofocus (page 108).

It also has functions which give you more control over focusing. Operate these from the body of the XL lens.

Temporary focus override

You can adjust the focus temporarily without turning autofocus off. Turn the lens's focusing ring to set the focus. Autofocus will resume as soon as you take your hand away from the focusing ring.

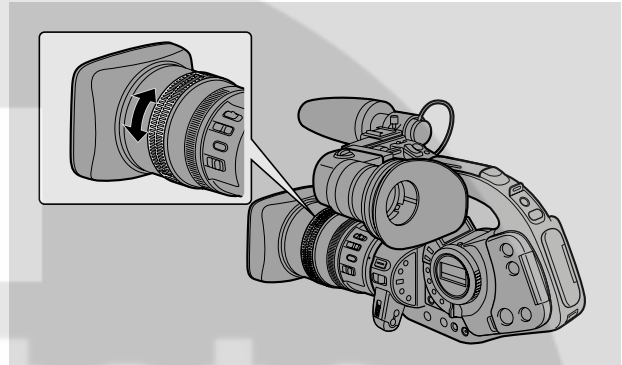

Manual focus

1. Slide the focus switch on the body of the XL lens to M (manual).
2. When using a zoom lens, rotate the zooming ring to the telephoto end.
3. Rotate the focusing ring to adjust the focus.
4. When using a zoom lens, use the zooming ring to reframe the subject.
 - To resume autofocus, slide the focus switch to AF (auto).
 - If you focus manually then leave the camcorder with the power turned on, you may lose focus on your subject. This possible slight shift in focus is due to a rise in temperature in the camcorder interior and lens. Check the focus before resuming shooting.

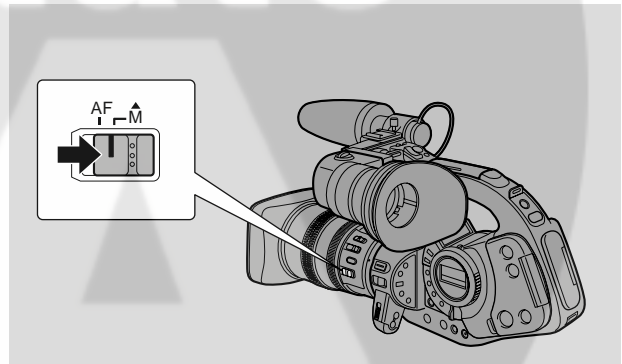

Push autofocus

Press the PUSH AF button during manual focusing, to quickly adjust the focus automatically. The camera will continue to focus automatically as long as you hold down the button. Release the button to continue to set the focus manually.

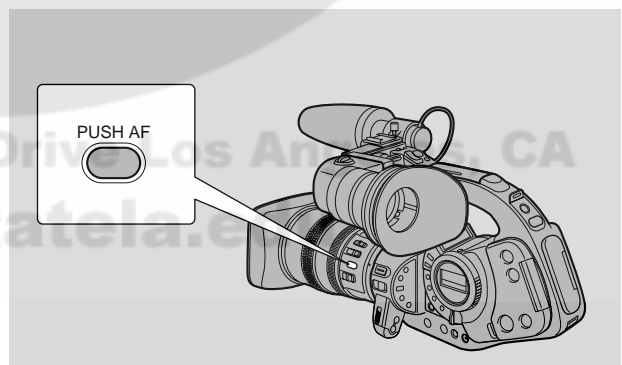

Adjusting the Exposure

Set the aperture value (of the iris) and the shutter speeds independently to give you total creative freedom in setting the exposure.

E

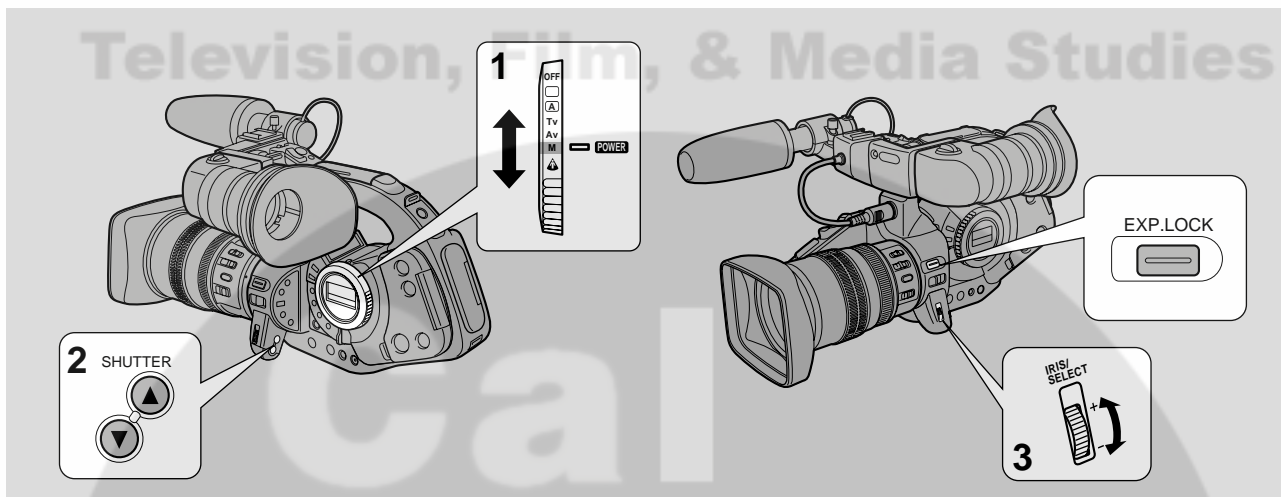

1. Turn the **POWER** dial to the **Manual recording program**.
2. Press the **SHUTTER** ▲ and ▼ buttons to increase or decrease the shutter speed.
 - Set the shutter to one of 27 speeds between 1/8 and 1/15,000 of a second.
3. Turn the **IRIS/SELECT** dial to open or close the iris.
 - Set the aperture value to one of 28 F numbers between f/1.6 and f/16, or select **CLOSE** to close the iris completely.

You can also vary the exposure manually in the Auto, Tv and Av modes, but you must first lock the exposure to activate the SHUTTER buttons, the IRIS/SELECT dial and GAIN knob.

- The maximum and minimum settings for the shutter and aperture are the same, but there are 12 possible speeds and 28 possible F numbers.

Exposure lock

You can lock the exposure at the current level in order to control the brightness of the image.

To lock the exposure, press the **EXP. LOCK** button. Press it again to return to the automatically set exposure level.

Notes:

- You cannot lock the exposure in the **M** (Manual) recording program.
- The standard exposure level depends on which recording program you have selected, but the shutter normally operates at 1/60 of a second.
- Exposure lock is canceled if you change the setting of the **POWER** dial.
- You cannot use exposure lock or adjustment when the **POWER** dial is set to the □ (Easy Recording) or ▲ (Spotlight) position.

www.calstatela.edu

Using AE Shift

E

By controlling the level of the automatic exposure (AE) function, you can lighten or darken the image slightly. This allows you to compensate for backlit subjects or subjects with predominately dark or light tones.

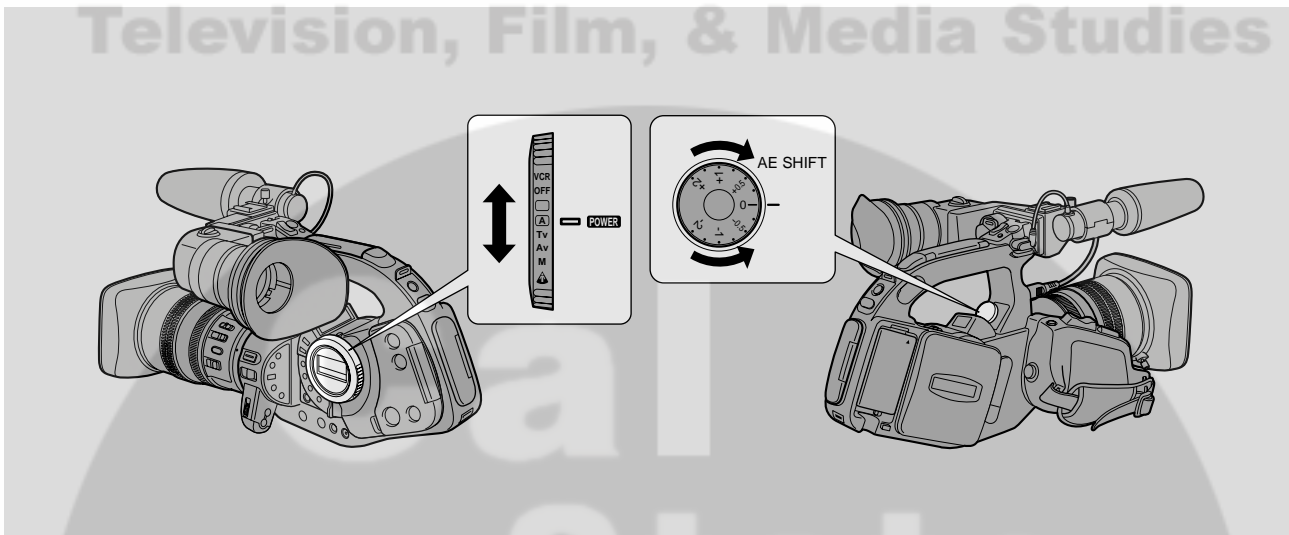

1. Turn the **POWER** dial to the Auto, Tv or Av recording program.
2. Turn the **AE SHIFT** dial to adjust the AE to your desired level.
 - To make the image brighter, turn the controller towards the + settings.
 - To make the image darker, turn the controller towards the – settings.

Note:

- AE shift does not function in the Easy, Manual or Spotlight Recording programs.

For instructional use only

For instructional use only

5151 State University Drive Los Angeles, CA
www.calstatela.edu

Using the Custom Preset

You can alter the color gain, color phase, sharpness and setup level for more creative videos. You can also save these settings under three custom preset and use them at any time.

Selecting the custom preset number

MENU

(see p. 26)

▶CSTM PRESET▶

▶▶ PRESET No. . . ▶◀◀1▶

1. Turn the **POWER** dial to any recording program (except Easy Recording program).
2. Open the menu and select **CSTM PRESET**.
3. Select **PRESET No.**, then select the number you want.

Setting the custom preset function

- When you adjust the custom preset, be sure to check the result before you start recording.
1. Select the function you want to adjust.
 2. Adjust the selected function.
 - Repeat steps 1 and 2 to adjust other functions as needed.
 3. Close the menu.
 - Your settings are saved and valid until new changes are made.

Adjusting the color gain

MENU

(see p. 26)

▶CSTM PRESET

▶▶ COLOR GAIN . . ▶-◻◻◻+

Adjust toward + for a deeper color, and toward – for a lighter color.

Adjusting the color phase

MENU

(see p. 26)

▶CSTM PRESET

▶▶ COLOR PHASE . ▶G◻◻◻R

Adjust toward R for a redder picture, and toward G for a greener picture.

Adjusting the sharpness

MENU

(see p. 26)

▶CSTM PRESET

▶▶ SHARPNESS . . . ▶-◻◻◻+

Adjust toward + for a sharper picture, and toward – to soften the contour.

Adjusting the setup level

MENU

(see p. 26)

▶CSTM PRESET

▶▶ SETUP LEVEL . ▶-◻◻◻+

Adjust toward + for a brighter picture, and toward – for a darker picture.

E

Recording

Using the custom preset function

1. Turn the **POWER** dial to any recording program (except Easy Recording program).
2. Select the custom preset number you want to use by pressing the **CSTM PREST SELECT** button.



- When you do not use the custom preset, select CP OFF.
3. Press the **CSTM PRESET ON/OFF** button to turn the custom preset on.
 - The picture now reflects your preferences.

Using the Zebra Pattern

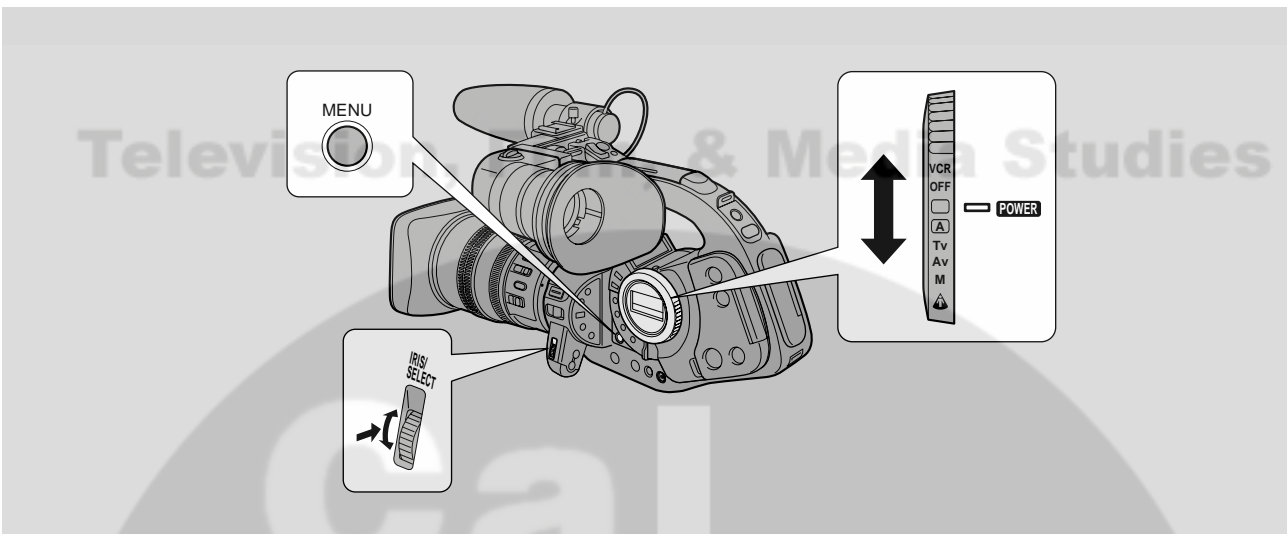

The zebra pattern is a series of diagonal stripes that appear in the viewfinder to highlight areas of overexposure. Use as a guide to setting the aperture (iris) and shutter speed.

You can also select the pattern appearance level from 80, 85, 90, 95, and 100%.

Selecting the zebra pattern level

1. Open the camera menu and select **CAM. SET UP**.
2. Select **ZEBRA LEVEL**, then select the level.
3. Close the menu.

MENU

(see p. 26)



Activating the zebra pattern

1. Open the camera menu and select **CAM. SET UP**.
2. Select **ZEBRA**, then select the **ON** setting.
3. Close the menu.

MENU

(see p. 26)



Note:

- The camera does not record the zebra pattern, it is only shown in the viewfinder.

E

Recording

Recording the PC Screen or other equipment using CLEAR SCAN

E

By using the Clear Scan function, you can record the PC screen or other equipment without annoying black band* on the picture.

* Difference in the field frequencies of the PC screen and the camera causes the black band.

• Frequency range is from 61.9Hz to 201.5Hz.

Television, Film, & Media Studies

1. Turn the POWER dial to Tv or M.
2. Select CS (Clear Scan) by pressing the SHUTTER ▲ button.
3. Open the camera menu and select CAM. SET UP.
4. Select CLEAR SCAN, then select the frequency to hide the black band in the viewfinder.
 - You can select the frequency from 117 steps.
5. Close the menu.

MENU

(see p. 26)

▶CAM. SET UP▶



CLEAR SCAN•▶61.9Hz

For instructional use only

Recording

For instructional use only

5151 State University Drive Los Angeles, CA
www.calstatela.edu

Adjusting the Gain

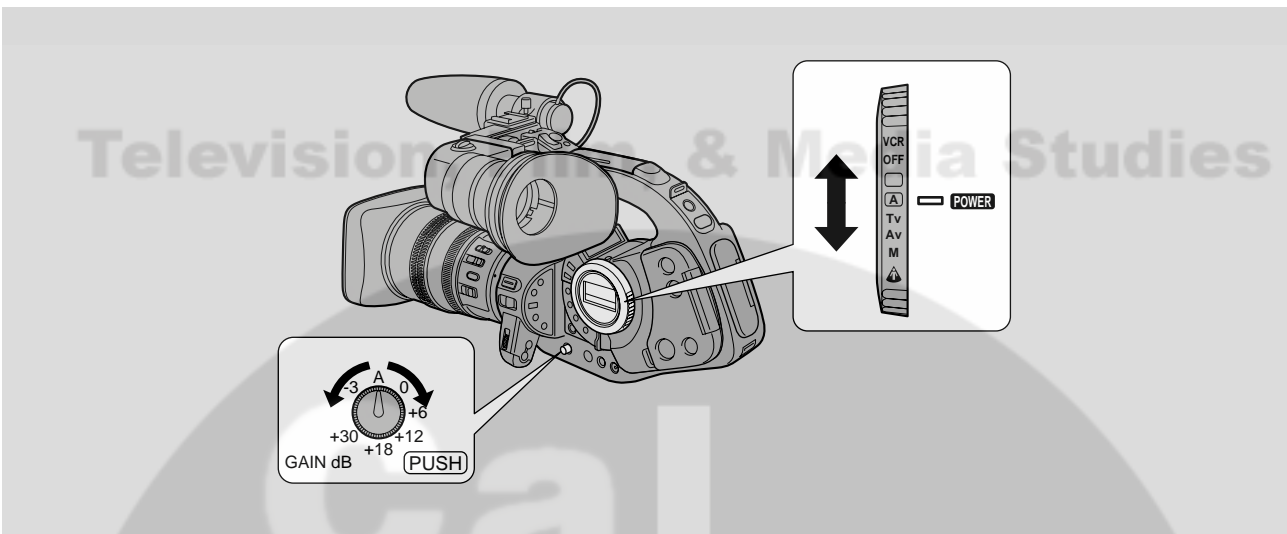

When the GAIN knob is set to (A) (auto) the camera adjusts the gain automatically. You can also rotate the GAIN dial to one of the 6 preset levels that range from -3 to $+30$ dB.

1. Turn the **POWER** dial to any recording program except (Easy Recording) or (Spotlight).
2. Press the **GAIN** knob so that it pops out. You can now turn it to adjust the gain to your desired level.
 - The gain level you select appears in the viewfinder.
 - Push the knob back in when you have finished making adjustments.

-3 dB: Low noise recording for indoor, low light or low contrast scenes.

0dB: Low noise, life-like color reproduction of illuminated scenes at night.

$+6$ dB/ $+12$ dB/ $+18$ dB/ $+30$ dB:

Brighten indoor or low-light scenes (when the iris is fully open).

Gain-up to enable you to increase the depth of field from using a smaller iris aperture.

Note:

- You cannot use the GAIN in the Easy Recording or Spotlight recording programs.

5151 State University Drive Los Angeles, CA
www.calstatela.edu

Adjusting the White Balance

E

The camera's auto white balance system compensates for a wide range of lighting conditions. Although slight variations are unavoidable, colors will appear natural in virtually every situation.

In some cases, you will get better results by setting the white balance manually.

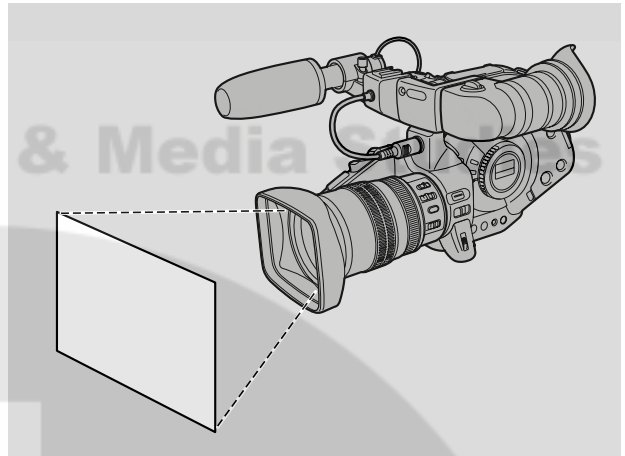

The XL1S has 2 modes other than fully auto (A) and manual (M):*



☾ Indoor mode (3200K light)

☀ Outdoor mode (5600K sunlight)

* You can memorize up to 3 manual settings.



Setting the white balance

E



1. Turn the **POWER** dial to any recording program (except the Easy Recording program).
2. Press the white balance selector knob so that it pops out. You can now turn it to choose between **A** for auto white balance,  for indoor lighting,  for outdoor lighting, or turn it to the right (1, 2 or 3) to set the white balance manually.
 -  appears in the viewfinder when you set the white balance to the indoor/outdoor modes.

Setting the white balance manually

When you select the number by turning the knob to the right, you can set the white balance manually.

- a) Point the camera at a white object (such as a sheet of paper) and if you are using a zoom lens, zoom in until it fills the display.
 - Keep the camera pointing to the white object until you have finished setting the white balance.
- b) Press the **WHITE BALANCE**  set button.
 -  flashes quickly in the viewfinder and then remains lit, to show that the camera has set the white balance.
 - Depending on the light source, the flashing may at times change to a slower speed, rather than remain lit. The result will remain better than with the auto setting, and you can continue recording.
- c) Turn the white balance selector knob back to **A** to return to the auto setting. Push the knob back in when you have finished making selections.
- d) You can recall any of the 3 manual white balance settings by turning the knob to the desired number. Setting the white balance manually will probably work better than auto white balance when shooting:
 - Subjects with one dominant color, such as sky, sea or forest.
 - Close-ups.
 - In rapidly changing lighting conditions.
 - In places lit by certain types of fluorescent or mercury vapor lights.

Notes:

- If the lighting conditions change, reset the white balance by first returning to the auto setting, and then reselecting the manual balance.
- Try to record with light from a single source. Correct white balance cannot be obtained for two types of lighting at once.
- You cannot set the white balance manually or use the indoor/outdoor modes when the **POWER** dial is set to the (Easy Recording) program. If you are already using a mode other than auto, the white balance returns to auto while you are in the (Easy Recording) program.
- If you shoot with studio/video lighting, use the  (indoor) mode.
- If you shoot under fluorescent lights use the automatic white balance or set the balance manually, since the camera may not adjust the white balance correctly in the  mode.
- When you turn the camera off, the camera remembers your white balance setting.

5151 State University Drive Los Angeles, CA

www.calstatela.edu

Recording

Playing back a Cassette

E

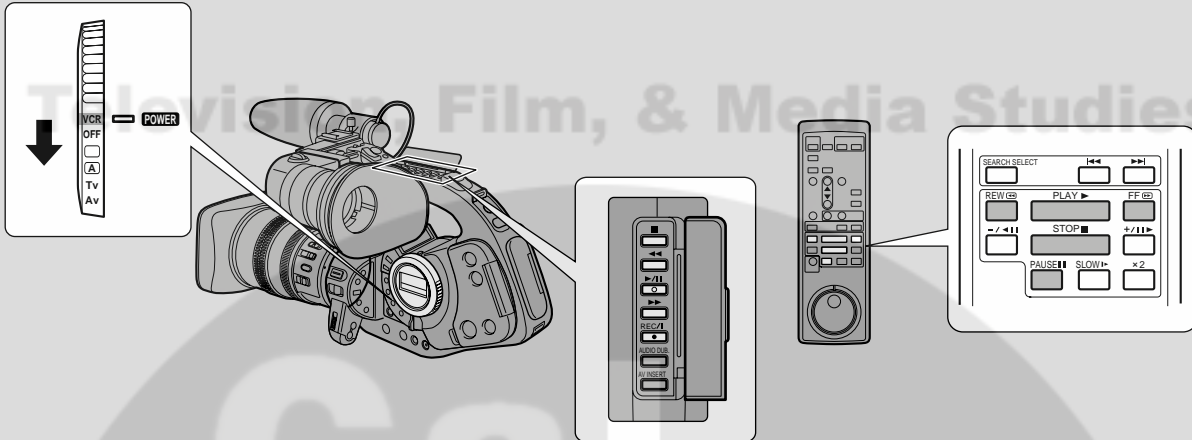

You can use the viewfinder for instant, on-the-spot playback.

To play back your recordings on a TV, see p. 83.

To use the wireless controller, see p. 30.

Notes:

- To avoid accidental recording, make sure that you slide the tab on the cassette so that it exposes the hole (the switch position is usually labelled SAVE or ERASE OFF).
- You cannot play back a tape recorded in **E**SP or **E**LP modes.

1. Attach a power source and turn the POWER dial to VCR.

2. Load the cassette.

3. Press the PLAY ► button to start playback.

- To end playback, press the STOP ■ button.
- To wind the tape forwards, stop playback and press the FF ►► button.
- To wind the tape backwards, stop playback and press the REW ◀◀ button.
- If the playback picture is rough (mosaic-like noise), clean the video heads using a Canon DVM-CL Digital Video Head Cleaning Cassette or a commercially available digital video head cleaning cassette.

Playback

5151 State University Drive Los Angeles, CA
www.calstatela.edu

Other playback modes

E

Playback Pause

To view the video as a still picture press the PAUSE **||** button. To resume normal playback, press it again, or press the PLAY **▶** button. The camera automatically goes into stop mode after about five minutes' playback pause.

Edit Search

When the camera is in playback pause, you can use edit search to play the tape forwards or backwards to find the point where you want to start or restart editing.

Press and hold the edit search + and – buttons (the REC SEARCH buttons) during playback, while you check the picture in the viewfinder.

- The + button plays the recording forwards and the – button plays it backwards.

Release the button when you find the point where you want to start editing.

- The camera returns to playback pause.

Fast Forward Playback

To play back the recording at about 9.5 times normal speed, press and hold the FF **▶▶** button during normal playback or press and hold the FF **▶▶** button during normal fast forward.

Rewind Playback

For reverse playback at about 9.5 times normal speed, press and hold the REW **◀◀** button during normal playback or press and hold the REW **◀◀** button during normal rewind.

For instructional use only

For instructional use only

Playback

5151 State University Drive Los Angeles, CA
www.calstatela.edu

Special playback

These can only be operated from the wireless controller (p. 30).

Frame Advance

To play back frame by frame, press the +/▶▶▶ button repeatedly during playback pause. Press and hold to play back continuous frame advance.

Frame Reverse

To play back on reverse frame by frame, press the -/◀◀◀ button repeatedly during playback pause. Press and hold to play back continuous frame reverse.

Slow Forward Playback

To play back at about 1/5 normal speed, press the SLOW ▶▶ button during normal playback. Press the PLAY ▶ button to return to normal playback.

Slow Reverse Playback

To play back in reverse at about 1/5 normal speed, press the -/◀◀ button and then the SLOW ▶▶ button during normal playback. Press PLAY ▶ to return to normal playback.

Reverse Playback

To play back in reverse at normal speed, press the -/◀◀ button during normal forward playback. Press the PLAY ▶ button to return to normal forward playback.

Forward ×2 Playback

Press the ×2 button during normal playback. Press the PLAY ▶ button to return to normal playback.

Reverse ×2 Playback

Press the -/◀◀ button and then the ×2 button during normal playback. Press the PLAY ▶ button to return to normal playback.

Shuttle Dial

Use the shuttle dial in play or playback pause mode to control the playback speed and direction. Turn the shuttle dial to different angles (see figure) to select slow, ×1 and ×2 playback modes (both forward and reverse), as well as fast forward and rewind playback. Turn it fully to the left/right to rewind/fast forward while the tape is stopped.

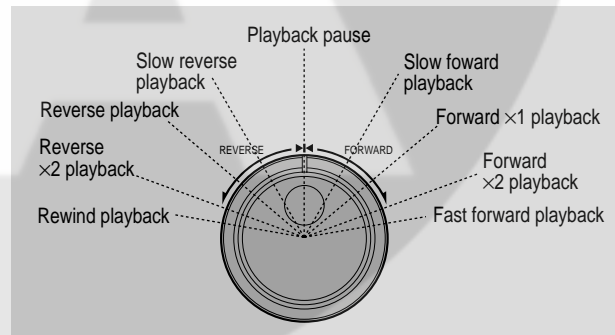

Jog Dial

Turn the Jog dial during playback or playback pause for frame advance/reverse or slow forward/slow reverse playback (depending on how far you turn the dial).

- When you stop turning the dial, the camcorder goes into playback pause mode.

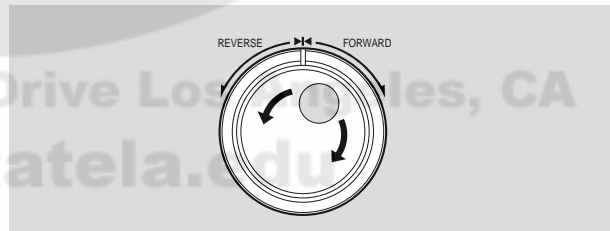

Note:

- Mosaic-like noise appears on the screen during some of the VCR modes.

Displaying Date, Time and Camera Data (Data Code)

A data code, containing the date and time the recording was made and other camera data (shutter speed and exposure settings) is automatically recorded on a special data section of the tape.

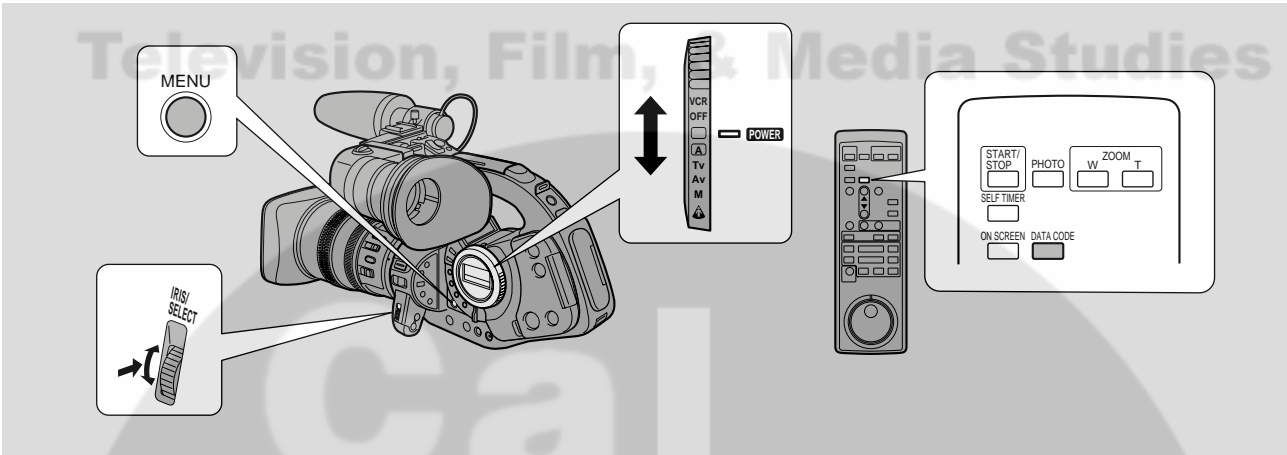

During VCR mode, the data code can be displayed or hidden while the camera is in play, slow or still mode.

Camera data may be displayed as “-- --” during fast forward, rewind, reverse playback, forward and reverse ×2 playback.

Press the DATA CODE button on the wireless controller while the camera is in play, slow or still mode.

- Press it once to display, once more to hide it.

Selecting date/time

Select whether you want the date, the time, or both to show up on your data code display (p. 32).

MENU

(see p. 28)

▶ DISP.SET UP ▶

▶▶ D/TIME SEL. ▶▶ DATE & TIME

To change the date and time combination, open the VCR menu and select DISP.SET UP. Then select D/TIME SEL., set it to DATE, TIME or DATE & TIME and close the menu.

5151 State University Drive Los Angeles, CA
www.calstatela.edu

E

Playback

Setting the data code

You can also choose to display camera data (shutter speed and exposure settings) in cassette data codes.

MENU

(see p. 28)

▶ DISP.SET UP ▶

▶▶ DATA CODE...▶DATE/TIME

To change, open the VCR menu and select DISP.SET UP. Then select DATA CODE, set it to DATE/TIME, CAMERA DATA or CAM. & D/T and close the menu.

Possible data code combinations for cassettes:

DATA CODE (cassette only) D/TIME SEL.	Date/Time	Camera data	Date/Time & Camera data
Date	JAN. 1, 2001	-3dB F1.6 1/15000	-3dB F1.6 1/15000 JAN. 1, 2001
Time	1:23:45 PM	-3dB F1.6 1/15000	-3dB F1.6 1/15000 12:00:00 AM
Date & Time	1:23:45 PM JAN. 1, 2001	-3dB F1.6 1/15000	-3dB F1.6 1/15000 12:00:00 AM JAN. 1, 2001

Notes:

- The data code will read “-- --” in the following situations:
 - During playback of a blank section of tape.
 - If the tape was recorded before entering the date and time in the camera’s memory.
 - If the tape was recorded on a camera without a data code function.
 - If noise or tape damage prevents the data code from being read.
- If a recording made on XL1S is played back on a different DV camcorder, the data code may not be displayed correctly.
- The data code will appear in the display even if DISPLAYS (p. 37) has been set to OFF through the menu.

5151 State University Drive Los Angeles, CA
www.calstatela.edu

Searching the Tape (Photo Search/Date Search/Index Search)

E

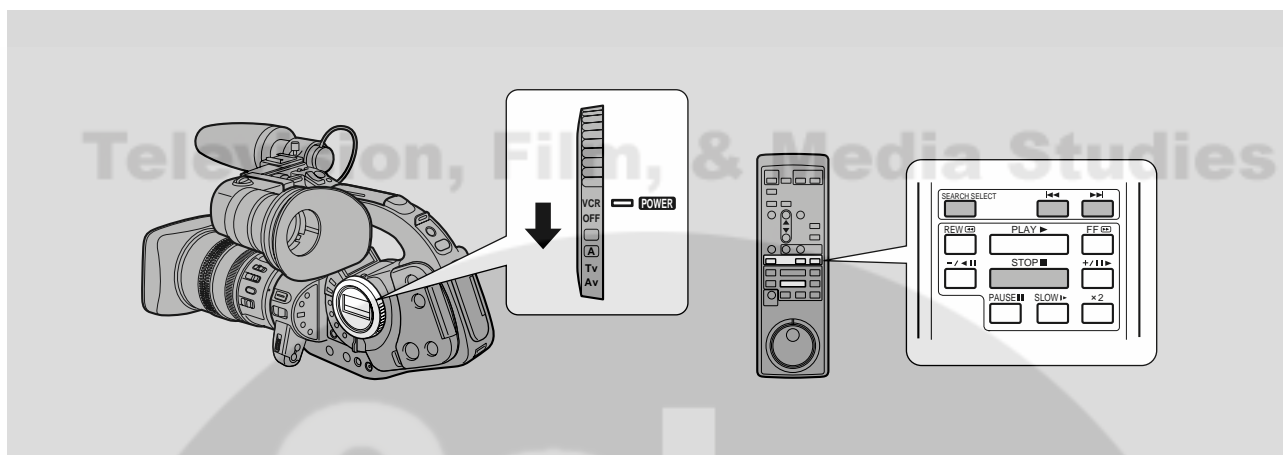

This allows you to move quickly through still pictures recorded anywhere on a tape (photo search), between different days or areas of recording (date search), or index signals recorded anywhere on a tape (index search).

1. Press the **SEARCH SELECT** button to choose between photo/date/index search.
 - PHOTO SEARCH, DATE SEARCH or INDEX SEARCH is shown in the display for 4 seconds.
2. Press the **◀◀** and **▶▶** buttons to move backwards or forwards through the still pictures, between different days of recording or recorded index signal.
 - Press once to move to the start of the previous/next still picture, day or index on the tape.
 - You can press more than once to move to the corresponding still picture, day or index (up to a maximum of 10 times), e.g. press the **▶▶** button 5 times to move forward 5 still pictures, days or index signals.
 - PHOTO SEARCH/DATE SEARCH/INDEX SEARCH appears in the middle of the viewfinder alongside the **◀◀** or **▶▶** mark and number to search through. You can change direction easily by pressing the button for the opposite direction.

Notes:

- Press **■** (stop) to stop mid-search.
- If you begin a search very close to the start of a recorded still picture during photo search, the camera may skip straight past it.
- When you have set the area for the World Clock, date search also looks for the change in date based on the adjusted time.
- A date/area cannot be identified if the total recording time on that day/area was less than 1 minute.
- Date/index search playback may start just before or after the beginning of the located section.
- If the data code is not displayed correctly you will not be able to operate the date search correctly.

5151 State University Drive Los Angeles, CA
www.calstatela.edu

Playback

Returning to a Pre-Marked Position

E

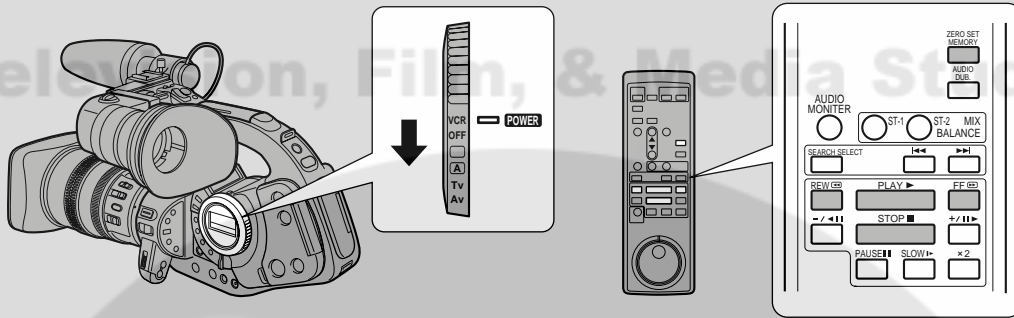

Use the wireless controller to mark a point on a tape that you want to return to following playback.

- 1. Press the ZERO SET MEMORY button on the wireless controller during playback at a point you want to return to later.**
 - The time code is replaced by a tape counter that is set to zero with the **M** indication.
 - Press the ZERO SET MEMORY button once more to cancel the zero set memory.
- 2. When you have finished playback, fast forward or rewind the tape. The tape stops automatically when it reaches the zero set position.**
 - RTN▶▶ or ◀◀RTN appears in the display.
 - The tape counter with **M** indication disappears from the display and the time code reappears.

Notes:

- The zero set memory may not function correctly where there is a break between recordings on the tape.
- You can also use zero set memory to mark a position on a tape in camera mode. When you then play back the tape, pressing rewind will take you back to the pre-marked position.
- If you remove the tape while the zero set memory is set, the memory is canceled and the tape counter reverts to time code.
- The camera remembers your setting even if you turn it off and back on again or move the POWER dial.

For instructional use only
Playback

For instructional use only

5151 State University Drive Los Angeles, CA
www.calstatela.edu

Connections for Playback on a TV Screen

For higher picture quality, we recommend playing back recordings on a TV with an S (S1) terminal. If you connect the camcorder to a TV with an S1 terminal or the Video ID-1 system, recordings made in the 16:9 mode for wide screen TVs will automatically play back in wide screen mode on the TV screen.

See your TV or VCR instruction manual for further details.

If your TV (or VCR) has an S-video input terminal

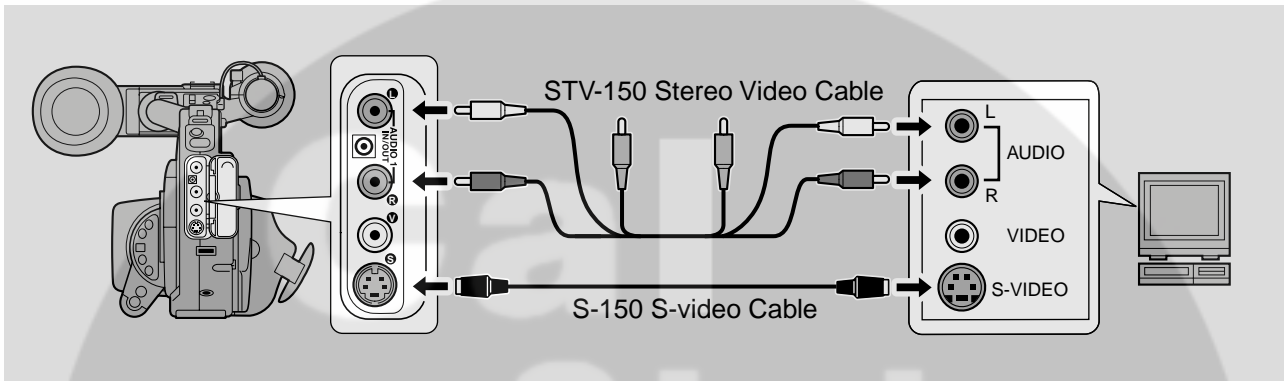

- Use the S-150 S-video Cable to connect the S-video terminal (S). Use the STV-150 Stereo Video Cable, to connect the AUDIO terminals. Connect the white plug to the white AUDIO terminal (L) (left). Connect the red plug to the red AUDIO terminal (R) (right). Do not connect the yellow plug.
- Set the TV/VIDEO selector on the television to VIDEO.
- If you are connecting the camera to a VCR, set the input selector on the VCR to LINE.

If your TV (or VCR) has audio/video input terminals

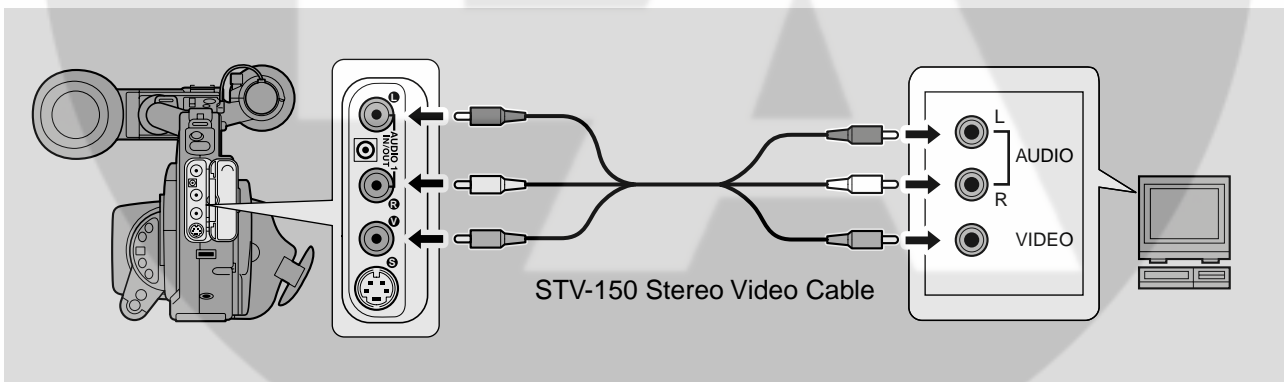

- Connect the camera using the STV-150 Stereo Video Cable. Connect the white plug to the white audio terminal (L) (left). Connect the red plug to the red audio terminal (R) (right). Connect the yellow plug to the yellow video terminal (V).
- Set the TV/VIDEO selector on the television to VIDEO.
- If you are connecting the camera to a VCR, set the input selector on the VCR to LINE.

Note:

- If you are going to use the TV as a monitor while you are shooting, remember to keep the TV volume turned down as long as the camera's audio terminals are connected to prevent feedback.

If your TV is already hooked up to a VCR, you can connect the camera to the VCR instead of the TV. Follow the instructions above.

Editing to a VCR

E

Playback the tape on the camcorder.

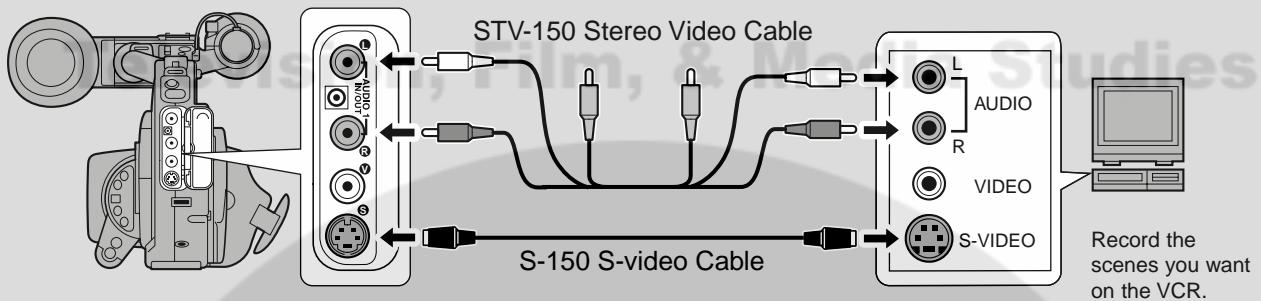

By connecting the camera to another VCR, you can edit your recordings in order to remove unwanted scenes — or combine different shots to create your own video productions.

Preparations

1. Connect the camera to the VCR.

- See “Connections for Playback on a TV screen” on p. 83.

2. Prepare the TV and VCR.

- Turn on the TV and set it to the video channel, or set the TV/VIDEO selector to VIDEO.
- Turn on the VCR, and set its input selector to LINE. Load a blank cassette, and put the VCR in record pause mode.
- See your TV and VCR instruction manuals for details.

3. Turn the camera's POWER dial to VCR, and load your recorded cassette.

Basic Recording

1. Find a point on your recorded cassette slightly ahead of the section you want to copy.
2. Start to play it back while you monitor the picture on the TV.
3. Start recording on the VCR as soon as the section you want to copy appears on the screen.
4. Pause the VCR at the end of the section you want to copy, then stop playback on the camera.
5. Repeat steps 1 to 4 until your edited recording is complete.



Note:

- The quality of the edited tape will be slightly lower than that of the original.

5151 State University Drive Los Angeles, CA

www.calstatela.edu

(LANC) terminal

The  terminal allows you to connect compatible devices such as remote controllers that are  LANC compatible. Some buttons on editing equipment may operate differently from those on the camera.

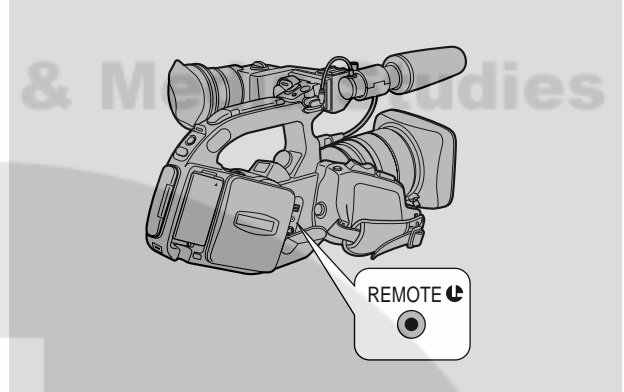

E

Notes:

-  (LANC) is a trademark. It stands for Local Application Control Bus System.
- We cannot guarantee the results when connecting to equipment not bearing the LANC  symbol.

Dubbing to/from a Cassette with Digital Video Equipment

E

Digital video equipment fitted with the DV terminal lets you edit, copy and transfer data digitally, with virtually no generation loss in image and sound quality. The DV terminal is for both line-in and line-out, since a single DV cable can handle data in both directions.

- If a digital VCR is connected and an anomalous signal is sent from the VCR, the images recorded on the tape may also be anomalous (although it may not appear so on the TV image), or not recorded at all.
- You are unable to dub tapes recorded with the copyright protective signal.
- You cannot dub a tape recorded in **E**SP or **E**LP modes.

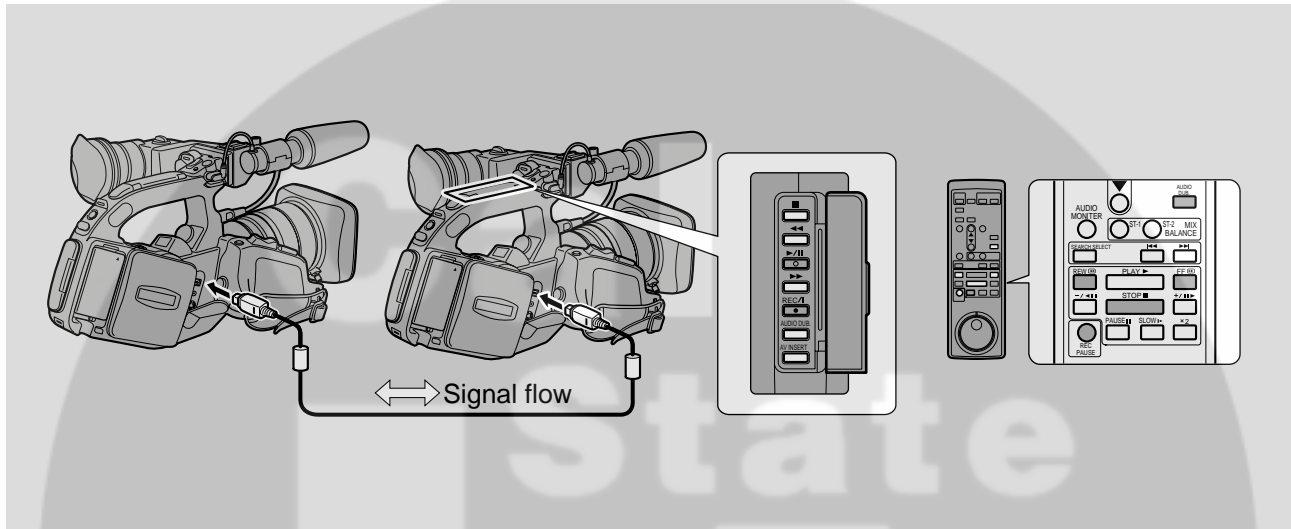

Preparations

Example dubbing to the camera

- 1. Connect the camera and the other digital device.**
 - Connect the Canon CV-150F DV cable (optional) with the sides of the plugs marked with the arrows facing as shown above.
- 2. Prepare the other device.**
 - Turn on the power and load a recorded cassette.
- 3. Turn the camera's POWER dial to VCR.**
 - DV IN appears in the viewfinder.
- 4. Load a blank cassette.**

Editing

5151 State University Drive Los Angeles, CA
www.calstatela.edu

Dubbing

E

1. Find a point on your recorded cassette slightly before the section you want to copy and set it to playback pause mode.
2. Press the camera's REC PAUSE button.
 - The camcorder enters record pause mode.
3. Start playback on the other digital device while you monitor the picture.
4. Press the play/pause ►/|| button on the camera body or the PAUSE || on the wireless controller.
 - Recording starts.
5. When you get to the point where you want to stop recording, press the stop button or the pause button.
 - Recording stops.
6. Stop playback on the other device.

Notes:

- If the cable is not connected properly, or if the cable is unconnected when you press REC PAUSE, the camera displays the caution "CHECK THE DV INPUT." An anomalous image may also flash onto the screen.
- Blanks between recordings on the playback tape are recorded as anomalous images on the tape that is being recorded to.

Copyright signal

Certain pre-recorded software tapes are copyright protected. If you try to play back such a cassette, "COPYRIGHT PROTECTED PLAYBACK IS RESTRICTED" appears in the viewfinder for a few seconds and then the camera displays a blank blue screen; you cannot view the contents of the cassette. If you try to record from such a tape via the digital cable "COPYRIGHT PROTECTED DUBBING RESTRICTED" appears in the viewfinder; you cannot record the contents of the tape.

For instructional use only

For instructional use only

Editing

5151 State University Drive Los Angeles, CA
www.calstatela.edu

Recording from a VCR, TV or Analog Camera (Analog Line-in)

E

You can record a video played on your VCR or analog camcorder (for digital camcorder, see p. 86) or a TV program onto a tape in the XL1S, if the TV or other device has audio/video outputs.

- By selecting the 12bit ST-1,2 of the AUDIO MODE from VCR SET UP of the VCR menu, you can record 4 channels.
- If an anomalous signal is sent from the TV or VCR, the images recorded on the tape may also be anomalous (although it may not appear so on the TV image), not recorded at all, or COPYRIGHT PROTECTED DUBBING RESTRICTED may appear in the viewfinder.
- You are unable to dub tapes recorded with the copyright protective signal.

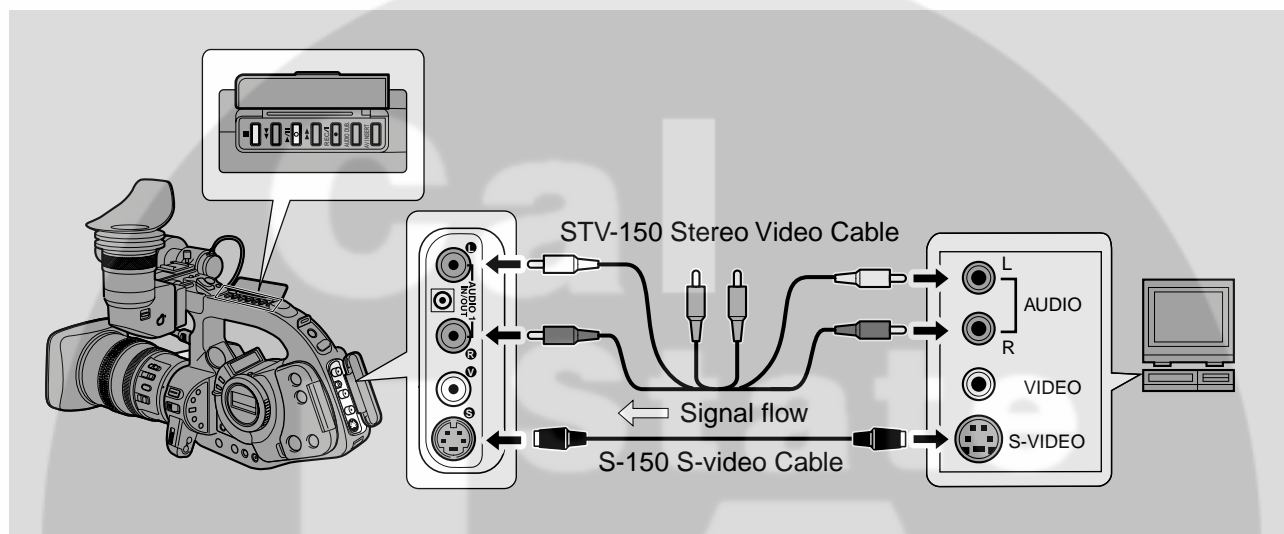

Preparations

1. **Connect the camera to the VCR, TV or other camera.**
2. **Prepare the device. (Example connecting to the VCR)**
 - Set the TV/Video selector on the television to Video. For further details, see “Connections for Playback on a TV Screen” on p. 83.
 - Turn on the VCR. Load your recorded cassette, and put the VCR in playback pause mode.
 - See your TV and VCR instruction manuals for details.
3. **Turn the camera’s POWER dial to VCR.**
4. **Slide the INPUT SELECT switch to AUDIO 1.**
5. **Select LINE of the AUDIO1 IN from VCR SET UP of the VCR menu.**
6. **Load a blank cassette.**

Editing

5151 State University Drive Los Angeles, CA
www.calstatela.edu

Dubbing

E

1. Find a point on your recorded cassette slightly before the section you want to copy and set it to playback pause mode.
2. Press the **REC PAUSE** button.
 - S-video and audio IN/OUT terminals work as input terminals.
 - The camera enters record pause mode.
3. Start playback on the other device or turn on the TV to see the desired program while you monitor the picture.
4. Press the play pause ►/|| button on the camera body or **PAUSE** || button on the wireless controller.
 - Recording starts.
5. When you get to the point where you want to stop recording, press the stop button or the pause button.
 - Recording stops.
6. Stop playback on the other device.

Note:

- You can monitor the picture in the viewfinder.

For instructional use only

For instructional use only

Editing

5151 State University Drive Los Angeles, CA
www.calstatela.edu

Recording Over Existing Scenes (AV Insert Editing)

E

You can insert new scenes from your VCR or other camcorder onto your pre-recorded tape using the XL1S's analog line-in or DV in terminals. Original video and audio will be replaced with the new video and audio.

- When you make AV insert editing using the DV in terminal, you cannot insert new scenes from a tape recorded in **E**SP or **E**LP modes.

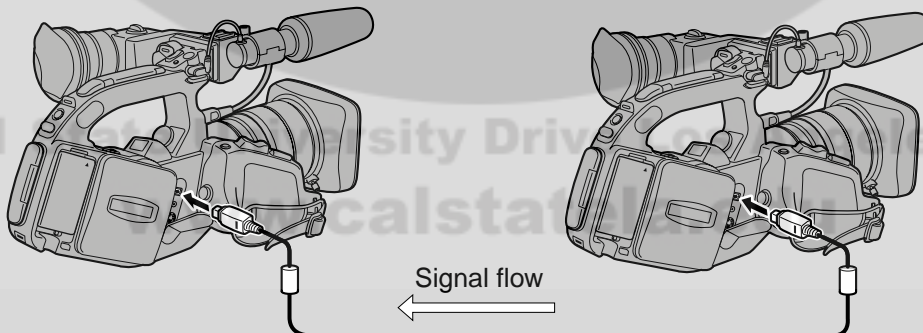
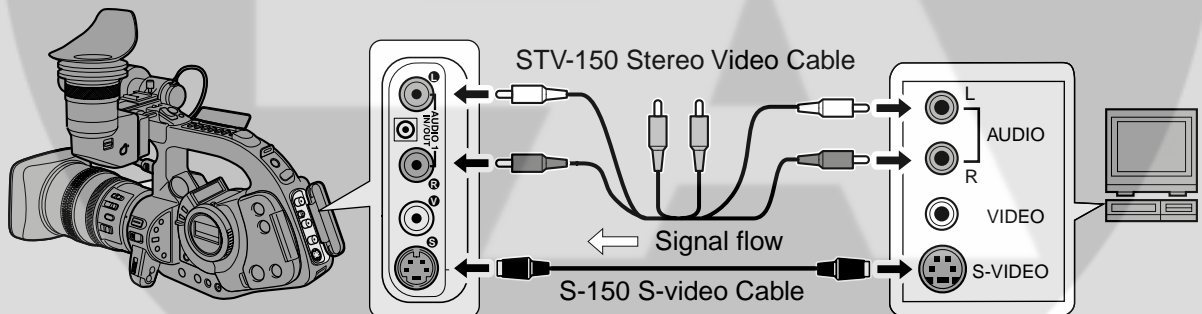
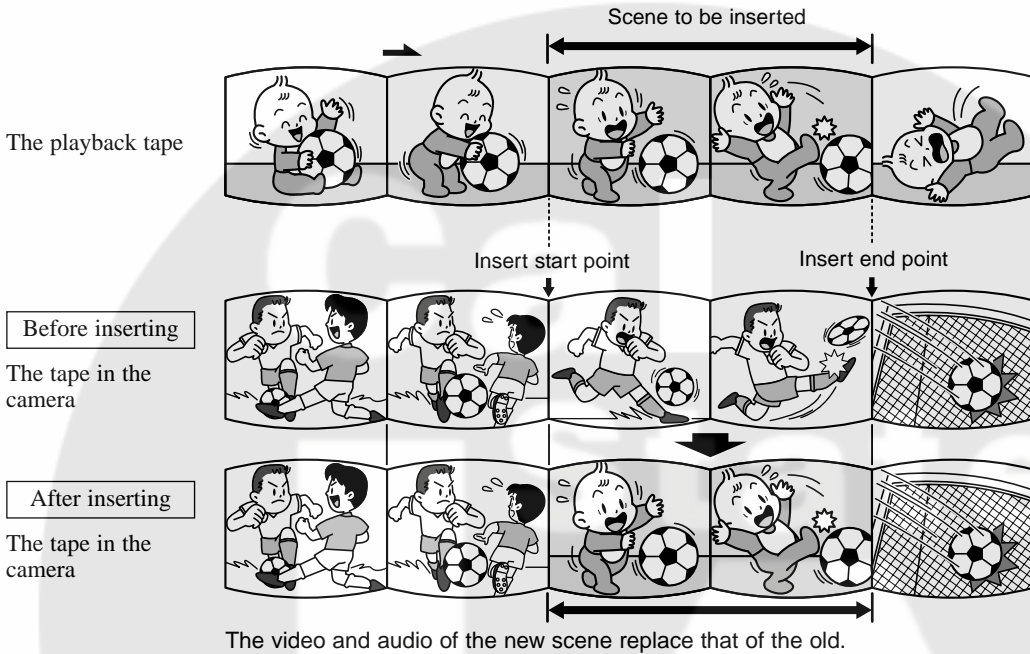

Preparations

E

The tape in the camera:

When using the XL1S's AV insert function, only record to tapes recorded in SP mode with continuously recorded time codes.

If there are non-recorded portions or portions recorded in a mode other than SP mode on the tape, recording will stop.

The playback tape:

Use only tapes without non-recorded portions.

If there are non-recorded portions or changes in the recording mode, you may not be able to insert AV correctly.

You cannot insert AV in the following cases:

- The playback tape has been poorly recorded.
- During special playback: fast forward playback, rewind playback or slow playback etc. (analog only).

TV:

You cannot insert AV from a TV program with anomalous synchronized signals, such as when the program itself received poor signals.

Example recording from a VCR

- 1. Connect the camera to the VCR.**
- 2. Prepare the VCR and TV.**
 - Set the TV/Video selector on the television to Video. For further details, see "Connections for Playback on a TV Screen" on p. 83.
 - Turn on the VCR and load a recorded cassette.
 - See your TV and VCR instruction manuals for details.
- 3. Slide the INPUT SELECT switch to AUDIO 1.**
- 4. Select LINE of the AUDIO1 IN from VCR SET UP of the VCR menu.**
- 5. Turn the camera's POWER dial to VCR and load a recorded cassette.**
 - Make sure the REC/SAVE tab on the cassette has been slid to REC (closed position).

5151 State University Drive Los Angeles, CA
www.calstatela.edu

Editing

Editing

1. **On the VCR, locate a point 3 seconds before the scene to be inserted. Set the VCR to playback pause mode.**
2. **On the camera, press PLAY and locate the recording start point. Set the camera to playback pause mode.**
 - You can use the playback buttons on the body of the camera or the special playback functions on the wireless controller in the same way as in playback mode.
3. **Press the AV INSERT button.**
 - AV INSERT and ●|| appear in the viewfinder.
4. **Play back the cassette in the VCR.**
5. **To start inserting, press the play pause ►/|| button on the camera.**
 - ●|| changes to ●.
6. **To stop inserting, press the STOP button on the camera.**
 - Inserting stops and AV INSERT disappears from the viewfinder. The camera returns to stop mode.
 - If instead of pressing STOP you press play pause ►/||, the camera returns to the AV insert pause mode.
 - If you set the zero set memory at the position on the tape where you want to stop inserting, every time you return to that point, the camera will cancel its AV inserting and enter stop mode.
7. **Stop playback on the VCR.**

Audio Dubbing

You can add sound to the original sound on a pre-recorded tape from audio products (AUDIO 1) or with the provided or external microphone (MIC). The original sound will not be erased. For best results, add sound to tapes that have been recorded with this camcorder in SP mode with 12-bit ST-1 sound. If there are non-recorded portions on the tape, or portions recorded in a mode other than SP mode, or with 16-bit or 12-bit, 4-channel sound, dubbing will stop. If your tape hasn't been recorded in SP mode with 12-bit ST-1 sound, we recommend dubbing your original tape onto a blank tape using the XL1S's analog line-in function, then dubbing audio onto the new tape. Make absolutely sure to set the audio mode of the new tape to 12-bit ST-1 and the recording mode to SP.

- You cannot add audio using the AUDIO 2 terminal.

To connect other audio equipment (using AUDIO 1 IN terminal) :

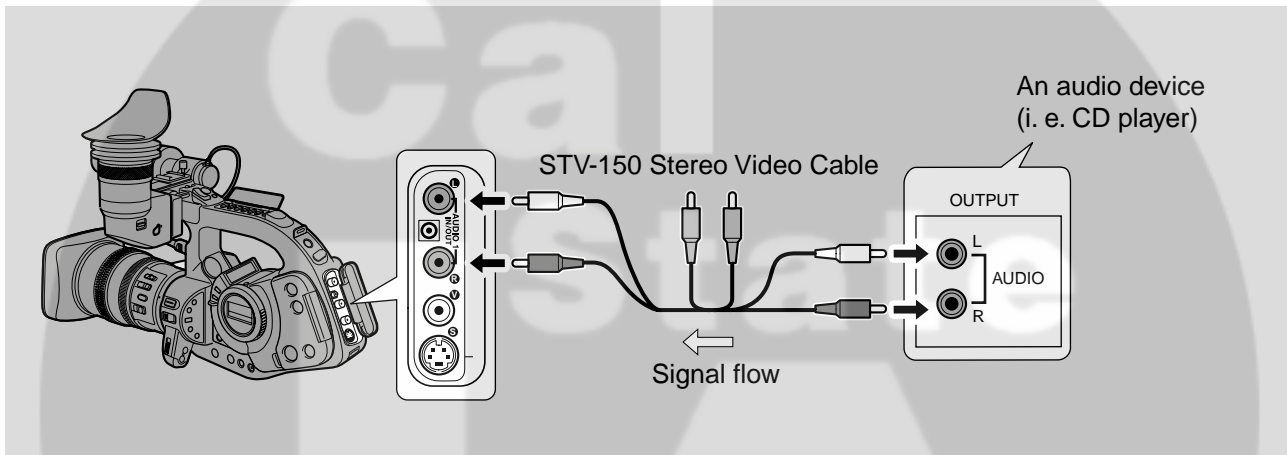

Note:

- When you are using the AUDIO1 RCA phono plug, the video or S-video terminal doesn't put out any video, so check the viewfinder as you add new sound. When you are using the microphone, you can check your TV connected by video terminal or S-video terminal.

Preparations

Turn the camera's POWER dial to VCR. Load a recorded cassette.

- Make sure the REC/SAVE tab on the cassette has been slid to REC (closed position).

Dubbing

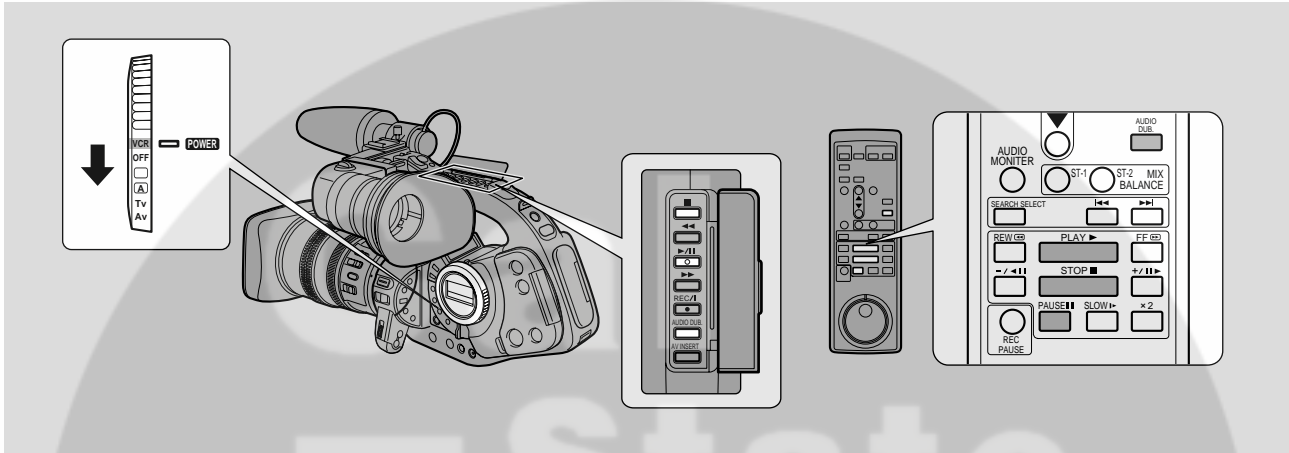

Do not connect/disconnect any cables to/from the camera when dubbing audio or preparing to dub audio.

MENU

(see p. 26)

▶ VCR SET UP ▶

▶▶ AUDIO 1 IN ◯▶ LINE

- Step 1 and 2 are the same operations as 2 Channel Recording.

1. Slide the INPUT SELECT switch to your input (MIC or AUDIO 1).

- When you use the AUDIO 1, select the input level from the AUDIO 1 IN of VCR SET UP of camera menu.

2. Adjust the recording level.



3. Locate the point where you want to start audio dubbing, then press the PAUSE button.

- You can use the playback buttons on the body of the camera or the special playback functions on the wireless controller in the same way as in playback mode.
- The camera becomes set to playback pause mode.

4. Press AUDIO DUB.

- AUDIO DUB. and  appear on the viewfinder.

5. Press the PAUSE button on the wireless controller or play pause button (and start play on the other audio device if AUDIO 1).

- Audio dubbing starts.
- If you are using the microphone, direct your voice into the microphone.
-  changes to .

6. When you get to the point where you want to stop dubbing, press the STOP button (and then stop play on the other audio device if AUDIO 1).

- Audio dubbing stops and AUDIO DUB. disappears from the viewfinder.
- The camera returns to stop mode.
- You can also set zero set memory (p.82) at the place you want to stop audio dubbing, then every time you return to that position, audio dubbing will cancel.
- If instead of pressing STOP you press PAUSE, the camera will return to the playback pause mode.

Notes:

- You cannot use the DV terminal while adding sound.
- You might want to adjust the audio mix (p.96) when playing back a tape with added sound.
- There may be a loss of sound quality if you add sound to a tape recorded on a camera other than the XL1S.
- After adding sound 3 or more times to the same place on a tape, there may be some loss in sound quality.

Selecting the Audio Output

E

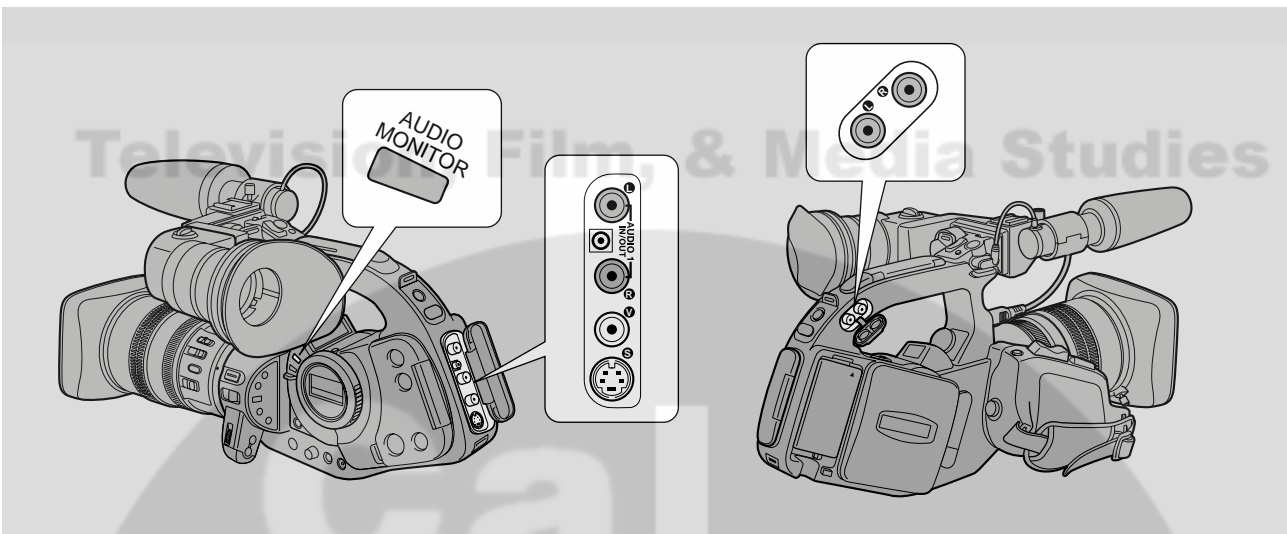

Set the audio output in two main stages: (i) Selecting the audio mix
(ii) Choosing the output channel

(i) Selecting the audio mix

When you play back a tape that was recorded in 12 bit mode, you can select the output: Stereo 1, Stereo 2 (4 channel recording or audio dubbing), or a mixture of the two.

- Audio from the 16 bit mode only contains stereo 1 sound, therefore it is not possible to select the audio mix. The same is true for the 12 bit stereo 1 mode, unless new sound has been added post-recording. Go directly to stage (ii).
- You only need to release the fixed level (step 2) if your aim is to mix the balance.

1. Set the camera to VCR mode.
2. Release the fixed level (for audio mixing only).

MENU

(see p. 28)

▶ VCR SET UP ▶

▶ MIX SELECT ◻ ◻ VARIABLE

- a) Open the VCR menu and select VCR SET UP.
- b) Select MIX SELECT, then select the VARIABLE setting.
- c) Close the menu.

3. Choose the output.

- a) Press the AUDIO MONITOR button to display “STEREO1”, “STEREO2”, and “MIX”, each in turn.
 - Your choice is selected a few seconds after you last pressed the button.

STEREO1 → STEREO2 → MIX



If you choose “MIX” you can go on to mix the balance.

- Use the MIX BALANCE ST-1, ST-2 keys to mix the balance. A bar showing the mix appears in the viewfinder for 4 seconds.

Notes:

- When you have chosen the output, “STEREO1”, “STEREO2”, or “MIX” is shown in the top left of the viewfinder and in the audio LCD panel. If you turn the power off, the output (and display) is set to “STEREO1”.
- You cannot mix the balance without first releasing the fixed level: the camera will show “FIXED” in the viewfinder.



(ii) Choosing the output channel

1. Make sure the camera is set to VCR mode.
2. Open the VCR menu and select VCR SET UP.
3. Select OUTPUT CH, then select the output channel.
4. Close the menu.

MENU

(see p. 28)



L/R (the default setting):

- If the audio mode is 16 bit or 12 bit stereo 1, the audio signal will be sent to the RCA jacks labeled L and R.
- If you chose stereo 1 for the output at stage (i), stereo 1 (L & R) will be sent to the RCA jacks labeled Audio 1 (L & R). In addition, stereo 2 (L & R) will be sent to the RCA jacks labeled Audio 2 (L & R). This gives you four independent audio signals.
- If you chose stereo 2 for the output at stage (i), stereo 2 (L & R) will be sent to Audio 1 (L & R).
- If you mixed the balance at stage (i), the combination of left channels from stereo 1 and stereo 2 will be sent to the left channel of Audio 1 and the combination of the right channels will be sent to the right channel of Audio 1.

L/L

- Only sound from the left channel(s) is output. This output is sent to the RCA jacks (L & R).

R/R

- Only sound from the right channel(s) is output. This output is sent to the RCA jacks (L & R).

L+R/R

- Gives a mono output. Sound from the left and right channels are combined and sent to the left RCA jack(s).

Note:

- The audio sent to connected headphones is the same as sent to the Audio 1 RCA jacks.

Notes on Using the Batteries

E

Charging and recording times

- These times may vary.
- You will get more recording time if you turn the camera off between shots, instead of leaving it in record pause mode.
- Recording time will be shorter than usual at low temperatures. You can use the battery pack between 32° and 104°F (0° to 40°C), but it works best between 50° and 86°F (10° to 30°C).
- If the battery pack starts to give you much less recording time than usual, it has reached the end of its life and must be replaced.

Battery pack	BP-930 (supplied)	BP-945 (option)
Time needed for full recharge	3h 30 min.	5h
Maximum recording time	1h 55 min.	2h 55 min.

How much power is left?

The indicator in the display shows you approximately how much charge the battery pack has left:

Notes:

- “CHANGE THE BATTERY PACK” appears in the display for 4 seconds when the power is completely exhausted. The empty battery mark then appears and starts to flash. The power indicator light also flashes.
- The indicator is not constant — different levels will be shown when you subject the battery pack and camcorder to different conditions.

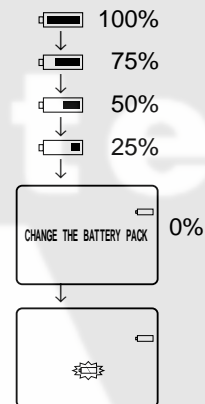

When to recharge

You can recharge a lithium ion battery pack whenever it is convenient. However, as the battery pack will naturally discharge itself over time, it is best to charge it the same day you plan to use it, or the day before.

Taking care of the battery pack

Always attach the terminal cover.

- Do not allow any metal objects to touch the terminals, as this can cause a short circuit and damage the battery pack. Attach the terminal cover whenever the battery pack is not being used.

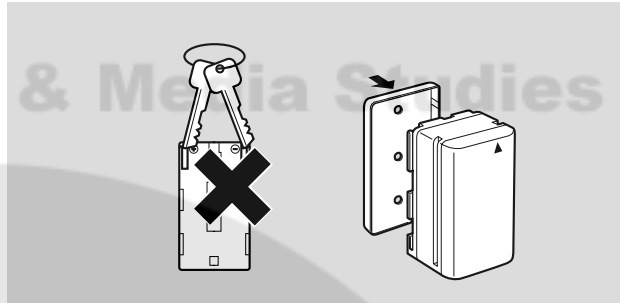

Keep the terminals clean.

- The camera, adapter or battery pack will not work properly if the terminals are dirty. Check them before use, and wipe them with a dry cloth or tissue if necessary.

Storing the battery pack

- If you do not use a battery pack for a period of more than a few months any remaining charge may cause damage to the battery pack, and reduce usage time. To prevent damage therefore, aim to use a battery pack's complete charge before storage.

Installing the backup battery

Pull out the battery holder from the base of the camera, and insert the CR2025 lithium battery with the + side facing upwards. Click the holder back into place.

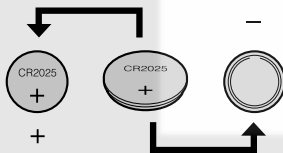

This backup battery allows the camera to remember the date and time and other settings when the main power source is removed. It has a life span of about a year.

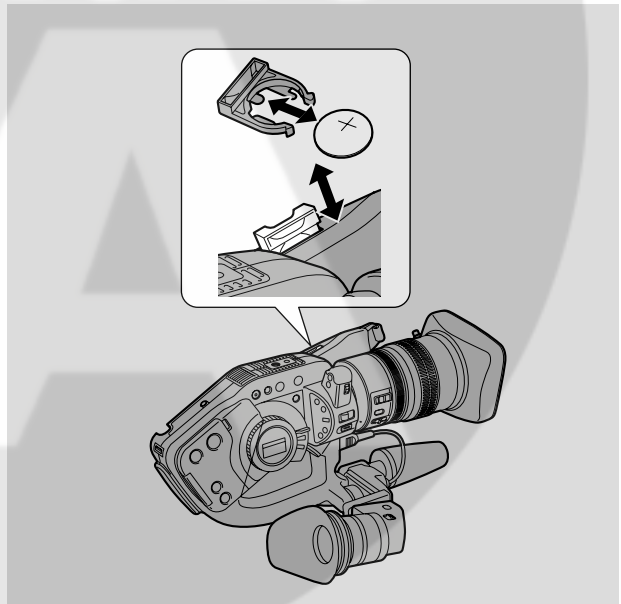

When it needs replacing (or if it has not been installed), the  mark flashes in the display. Remove the old battery by pulling out the battery holder from the base on the camera. Make sure you attach a power source to the camera first, and turn it off using the STANDBY button. This way it will remember your chosen settings when you change the battery.

DANGER!**Treat the battery pack with care.**

- Keep it away from fire (or it might explode).
- Do not expose the battery pack to temperatures greater than 140°F (60°C). Do not leave it near a heater, or inside a car in hot weather, for example.
- Do not try to disassemble or modify it.
- Do not drop or knock it.
- Do not get it wet.

WARNING!

- The battery used in this device may present a fire or chemical burn hazard if mistreated. Do not recharge, disassemble, heat above 212°F (100°C) or incinerate.
- Replace the battery with a Sony, Hitachi Maxell, Sanyo or Panasonic CR2025, or Duracell DL2025. Use of another battery may present a risk of fire or explosion.

Cautions:

- Do not pick up the battery using tweezers or other metal tools — this will cause a short circuit.
- Wipe the battery with a clean, dry cloth to ensure proper contact.
- Keep the back-up battery out of reach of children — if it is swallowed, contact a physician immediately, as the battery case may break down and the battery fluids damage the stomach and intestines.
- Do not disassemble, heat, or immerse the battery in water, to avoid the risk of explosion.

Camera Holding Styles

Choose the grip

- You can grip the camera from the side grip, or top handle.
- Either gripping position allows you to start/stop recording, take a “photo” and zoom in and out.
- Lock the top controls to prevent accidental operation by flicking across the LOCK lever.

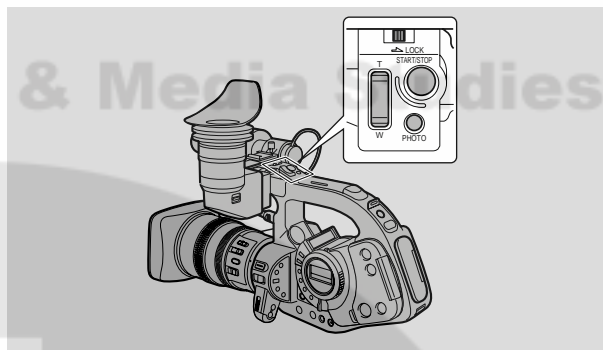

E

Standard holding style

For maximum stability, place your right hand through the side grip belt and keep your right elbow pressed against your body. Rest the rear of the camera against the front of your shoulder and then support the lens with your left hand.

Low-angle recording

Grip the camera using the top handle and steady the lens with the other hand.

Using a tripod

- To prevent any unwanted movement, mount the camera on a tripod and operate it from the remote control.
- Be careful not to leave the viewfinder in bright sunlight or it may damage the LCD. (the light is concentrated by the viewfinder lens.) Either turn the EYE POINT SELECT switch to the FAR setting, or change the angle of the viewfinder to move it out of direct sunlight.
 - Make sure the fastening screw of the tripod is no longer than 3/16 inch (5.5 mm), or it may damage the camera.
 - Do not attach a tripod to the socket meant for the shoulder pad (the socket closest to the rear of the camera).

5151 State University Drive Los Angeles, CA
www.calstatela.edu

Additional
Information

Function settings saved at POWER off or with the STANDBY button

E

The following function settings are saved when the power is turned off with the POWER dial or when the STANDBY button is pressed (with the backup battery installed):

● Camera mode

	Turning power off with the POWER dial	Pressing the STANDBY button
Aperture setting in Av mode		○
Shutter speed setting in Tv mode		○
Aperture, shutter speed setting in Manual mode		○
White balance set		○
Exposure lock on/off	Returns to off	○
Aperture, shutter speed setting during exposure lock	Reset	○
Digital effect select	Reset (except digital zoom)	○
Digital effect on/off	Reset (except digital zoom)	×
Camera menu setting*		○
Self-timer on/off	Returns to off	
Interval timer on/off	Returns to off	
TV screen on/off		○
EVF display	Returns to normal display	
LCD light	Returns to off	
Zero set memory counter		○

* Except self-timer and interval timer on/off.

For instructional use only

For instructional use only

Additional Information

5151 State University Drive Los Angeles, CA
www.calstatela.edu

The following function settings are saved when you switch to another recording program (with the backup battery installed):

E

● Camera mode

	Change to other recording program	Change to <input type="checkbox"/> (Easy recording)
Aperture setting in Av mode		○
Shutter speed setting in Tv mode		○
Aperture, shutter speed setting in Manual mode		○
White balance set		○
Exposure lock on/off	Returns to off	
Aperture, shutter speed setting during exposure lock	Reset	
Digital effect select	○	Reset (except digital zoom)
Digital effect on/off	○	Reset (except digital zoom)
Camera menu setting		○
Self-timer on/off		○
Interval timer on/off		○
TV screen on/off		○
EVF display		○
LCD light		○
Zero set memory counter		○

The following function settings are saved when you turn the POWER dial (with the backup battery installed):

● VCR mode

TV screen on/off	Returns to off
LCD light	Returns to off
Zero set memory counter	○
Data code display	Returns to off
Audio 12bit output	Returns to stereo 1
Mix balance select	○
Search select	Returns to photo search
VCR menu	○*

* Only an output channel returns to [L/R].

For instructional use only

Additional Information

Maintenance

E

Cautions

Avoid high temperatures and high humidity.

- Do not leave the camera inside a car in hot weather, for example.
- Be careful of heat radiating from video lighting equipment.
- Do not take the camera into a humid room.

Avoid sudden changes in temperature.

- If you take the camera from a cold place to a warm place, condensation may form on the lens and internal parts (see p. 106).

Do not point the lens or viewfinder at strong light sources.

- Never point it at the sun, and do not leave it aimed at a bright subject.
- Be especially careful when leaving the camera on a tripod.

Avoid magnetic or electric fields.

- Do not use the camera close to TV transmitters, portable communication devices or other sources of electric or magnetic radiation. They may cause picture interference, or permanently damage the camera.

Do not expose the camera to water.

- Cover the camera when you are recording in rain or mist.
- There is a risk of electric shock if water gets inside the camera — contact qualified service personnel as soon as possible.

Protect the lens.

- Sand and dust can damage the lens — be especially careful on windy days.

Handle the camera gently.

- Vibration or shock can cause damage.
- Do not use the viewfinder unit or microphone as a carrying handle.
- Do not swing the camera around when carrying it by the handle; knocking the camera against things may cause it to malfunction.

Do not disassemble the camera.

- This is very dangerous as there is a risk of electric shock — if the camera does not function properly, take it to qualified service personnel.

Storage

If you do not intend to use the camera for some time, store it in an area which is free of dust and moisture, and where the temperature is no higher than 86°F (30°C). After storage, check each part and function of your camera to make sure everything is still working properly.

Note:

- These cautions also apply to accessories such as battery packs and cassettes.

Maintenance

E

Viewfinder

- Clean the viewfinder screen. Slide and hold the release lever on the underside of the viewfinder and then twist the eye cup counter-clockwise (until the mark on the eye cup lines up with the mark on the viewfinder) to allow you to remove it. Clean the surface with a cotton swab. When finished, replace the eye cup (p. 16).
- The viewfinder screen scratches easily. Take care when cleaning.

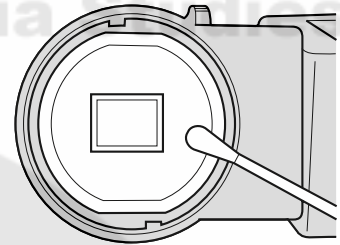

Camera body and lens

- Use a soft, dry cloth to clean the camera body or lens. Never use chemically treated cloth or volatile solvents such as paint thinner.

Video heads

- When mosaic-like noise appears on the playback picture, the video heads may be dirty. When the video heads are badly contaminated, the camera may show a blank blue screen.
- For the best picture possible, after using the camera for approximately 20 hours, clean the video heads using Canon's DVM-CL Digital Video Head Cleaning Cassette. If the "noise" remains, repeat the cleaning (up to maximum of 5 times).
- Do not use a wet-type cleaning cassette, as this can cause damage.



Using the camera abroad

Power sources

- You can use the compact power adapter to operate your camera and charge battery packs in any country where the electricity supply is between 110 and 240 V AC, 50/60 Hz. Contact your Canon dealer for information about plug adapters for overseas use.

TV playback

- Although you can always play back your recordings in the viewfinder, your camera can only be connected to TVs which use its NTSC system. This TV system is used in the following countries: American Samoa, Bahama, Barbados, Bermuda, Bolivia, Canada, Chile, Columbia, Costa Rica, Cuba, Ecuador, El Salvador, Guam, Guatemala, Greenland, Haiti, Honduras, Jamaica, Japan, Korea, Mexico, Micronesia, Myanmar, Nicaragua, Panama, Peru, Philippines, Puerto Rico, Saint Lucia, Surinam, Taiwan, Trinidad and Tobago, USA, Venezuela.

5151 State University Drive Los Angeles, CA
www.calstatela.edu

Additional
Information

Condensation

Condensation may form on the camera when it is moved from a cold place to a warm place. Using the camera while condensation is present can damage both the tape and the camera.



Condensation may become a problem:

- When you bring the camera from a cold place to a warm room
- When a cold room is heated rapidly
- When the camera is left in a humid room
- When the camera is taken from an air-conditioned room to a warm, humid place

Protecting the camera from condensation

- Before you bring the camera to a warm or humid place where condensation is likely to be a problem, unload the cassette and put the camera in a plastic bag. Wait until the camera reaches room temperature before you take it out of the bag.

What happens when condensation is detected

- “CONDENSATION HAS BEEN DETECTED” is displayed for approximately 4 seconds. Then, the power indicator flashes and the  mark flashes in the viewfinder. If there is a cassette in the camera, it stops automatically and “REMOVE THE CASSETTE” is displayed for approximately 4 seconds and then EJECT flashes in the viewfinder (without a cassette,  flashes instead).
- The camera may not detect the condensation immediately — the condensation warning may not start flashing for 10 to 15 minutes.
- You cannot load a cassette when condensation is detected.

What you should do

- Remove the cassette, leave the cassette compartment open, and turn the camera off.
- Leave it in a dry place until the condensation evaporates. After the condensation warning stops flashing, wait at least another hour before trying to use the camera.

Troubleshooting

Refer to this checklist first if you have any problems with your camcorder. Possible explanations are given for each problem on the list — turn to the page numbers in brackets for more information.

Make sure that the camera is properly connected if you are using it with a TV or VCR. Consult your dealer or service outlet if problems persist.

E

Recording/Playback

Problem

Cause and/or what to do about it

❓ Nothing happens when I press the buttons.

- The camera is not switched on (p. 35, 76).
- The cassette is not loaded or is set for erasure prevention (p. 22-23).
- The tape has reached the end.
- The battery pack is exhausted or not properly attached (p. 19-20, 98).
- The function cannot be used in that recording program (p. 47).
- The top controls are locked by the LOCK lever (p. 101).

❓ The camera turned itself off.

- The camera was in record pause mode for more than about five minutes (p. 35).
- The battery pack is exhausted (p. 98).

❓ The start/stop button doesn't work.

- The POWER dial is not set to a recording program (p. 46).
- The cassette is not loaded or is set for erasure prevention (p. 22-23).
- The tape has reached the end.

❓ There's no picture in the viewfinder.

- The POWER dial is not set to a recording program (p. 46).
- The camera has not been used for a long while, it is not a malfunction. Switch off the camera. Take off the battery and reattach it. Then switch on the camera again.

❓ There's a blank blue screen in the display.

- You are attempting to play back or record from a copyright protected cassette (p. 87).
- The tape heads are badly contaminated (p. 105).

❓ The camera won't focus.

- The camera is on manual focus (p. 66).
- The viewfinder lens needs adjusting (p. 17).
- The lens is dirty (p. 105).

For instructional use only

For instructional use only

Additional
Information

E**Note:**

Some subjects are not suitable for autofocus. In these situations, you will often get better results using manual focus (see p. 66).

- Horizontal stripes
- Many subjects at different distances
- Behind glass
- Without much contrast (e.g. a white wall)
- Reflective surfaces (e.g. shiny car surfaces)
- Fast moving objects
- Slanted subjects
- Dark subjects
- Night scenes

Recording/Playback (Contd.)

Problem

? Some/all of the digital effects don't work, or can't be set.

? The ► (play) button doesn't work.

? There's a bright stripe on the screen.

? The playback picture is rough (with mosaic-like noise).

? There's no picture on the TV screen, even though the tape is moving.

Cause and/or what to do about it

- There are a few restrictions on using the digital effects. Refer to the notes on p. 39.

- The POWER dial is not set to VCR (p. 76).
- The cassette is not loaded (p. 22).
- The tape has reached the end.

- When recording in dark places a bright light in the scene may cause a vertical light bar ("smear") to appear. This is a normal feature of camcorders.

- The video heads need cleaning (p. 105).

- The video heads need cleaning (p. 105).
- The TV/VIDEO selector on the TV isn't set to VIDEO (p. 83).
- A tape recorded in **E**SP or **E**LP modes cannot be played back.

Miscellaneous

E

Problem

Cause and/or what to do about it

❓ **The wireless controller doesn't work.**

- The remote sensor is turned off (p. 31).
- The batteries are dead or not inserted.

❓ **The tally lamps don't flash.**

- They are turned off (p. 31).

❓ **There are air bubbles inside the lens.**
(16× IS II lens)

- This is unlikely, but may happen if you use the camera in places where the air pressure is low, in an airplane for example. The bubbles will disappear a week or so after you return the camera to normal atmospheric pressure.

❓ **The camera malfunctions.**

- External interference may cause the camera's microprocessor to malfunction temporarily. If random letters appear in the display or if normal operation is interrupted, remove and then replace the power source (and if necessary, the back-up battery).

❓ **The viewfinder displays are unclear.**

- The EYE POINT SELECT switch is set to FAR (p. 17).
- The viewfinder focusing ring needs adjusting (p. 17).

❓ **The DV cable is connected correctly, but there's nothing in the display.**

- Remove the cable and then reconnect it or turn the power off and back on again.

❓ **The lens is attached, but LENS continues to flash in the viewfinder.**

- Make sure the lens has clicked fully into position. If necessary, turn the POWER dial to OFF, remove the lens and retry (p. 14).

About the LCD Viewfinder

Liquid Crystal Viewfinders use extremely high-precision technology, but there will be pixels which do not light up or which are continuously lit. This is not an error and will not affect the recording.

About the CCD

Due to the construction of the CCD, in low-light recording using the slow shutter or gaining up, small specks of light may become visible in the viewfinder. In such cases, increase the shutter speed, reduce the gain or use an additional light source such as a video light.

5151 State University Drive Los Angeles, CA

www.calstatela.edu

Additional
Information

The XL1S System Diagram (Availability differs from area to area)

E

For instructional use only

For instructional use only

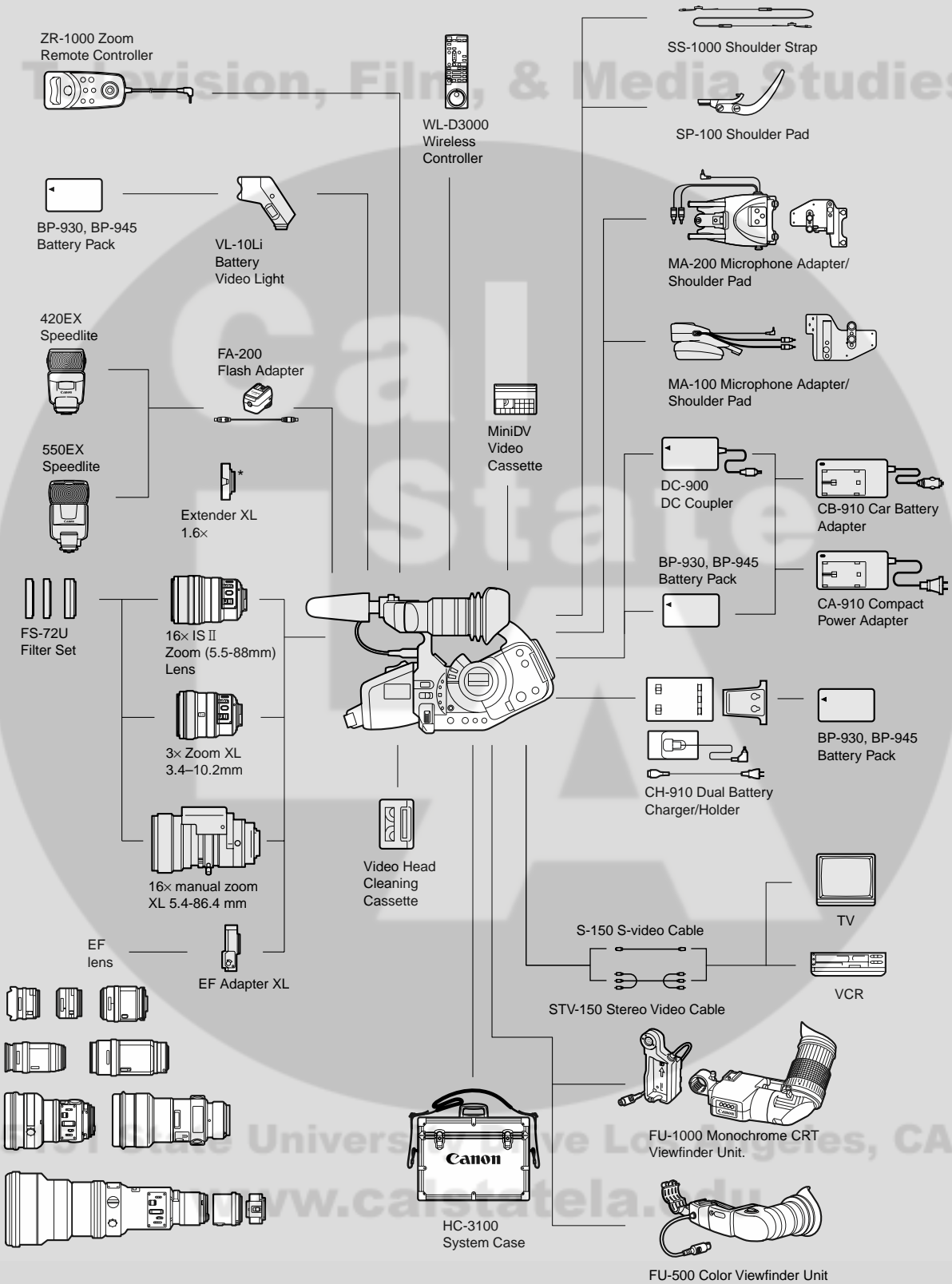

* Can be attached to the 16x IS II and 16x manual zoom lenses.

Additional Information

Optional Accessories

Call or visit your local retailer/dealer for genuine Canon video accessories. You can also obtain genuine accessories for your Canon camera by calling: 1-800-828-4040, Canon U.S.A. Information Center.

Battery Packs

The BP-930 is supplied as standard. It is also available as an optional accessory. The optional BP-945 provides 50% more recording time than the BP-930.

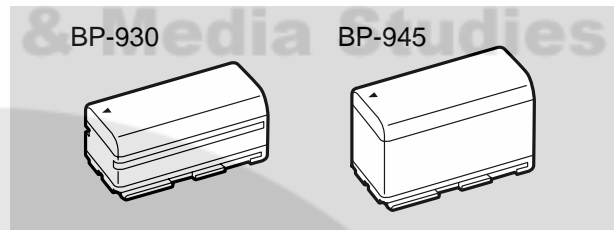

CB-910 Car Battery Adapter

Power your camera, or recharge battery packs on the move. The car battery adapter plugs into your car's cigarette lighter socket and runs off a 12-24V DC negative ground battery.

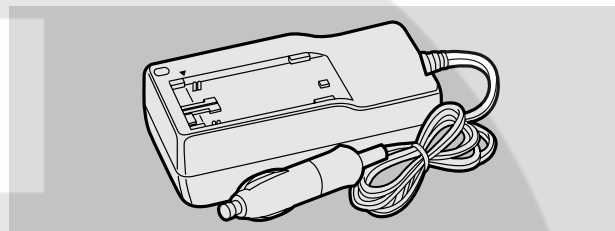

FS-72U Filter Set

Ultraviolet, neutral density and circular polarizing filters to help you take control of difficult lighting conditions.

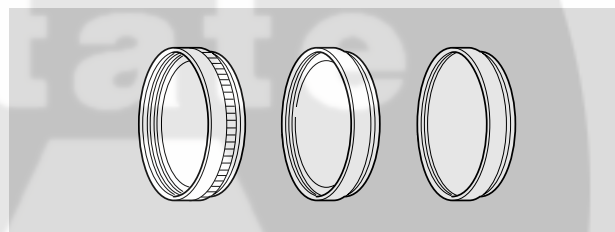

HC-3100 System Case

A solid, lockable case that provides safe and stylish protection for the camera during transportation and storage.



MA-100 Microphone Adapter/Shoulder Pad

Allows you to use a microphone that has XLR connectors with the XL1S, plus makes shoulder-mounted shooting possible. In addition, use it to attach a wireless microphone receiver or to hold the separately available CH-910 Dual Battery Charger/Holder.

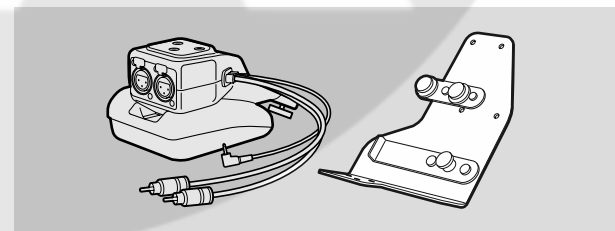

MA-200 Microphone Adapter/Shoulder Pad

Allows you to use a microphone that has XLR connectors with the XL1S and to have the video signal in BNC connector, plus makes shoulder-mounted shooting possible. In addition, you can attach a wireless microphone receiver or to hold the separately available CH-910 Dual Battery Charger/Holder. Different from the MA-100, you can use up to 4 microphones simultaneously with the MA-200.

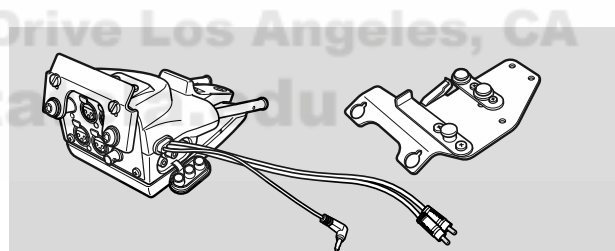

E

For instructional use only

For instructional use only

Additional
Information

FA-200 Flash Adapter

Facilitates use of a Canon Speedlite 420EX/550EX with the XL1S.

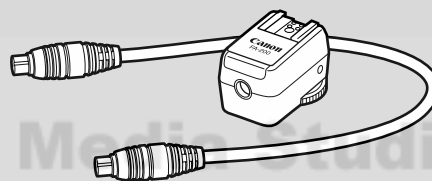
**3× Zoom XL 3.4–10.2mm**

A super wide-angle lens that gives a range of 24 – 72 mm (35mm film equivalent).

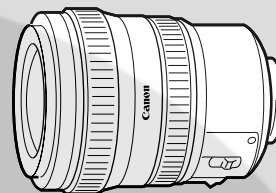
**16× Manual Zoom Lens XL 5.4–86.4mm**

A high-resolution zoom lens gives you 2 zoom modes (manual and powered), built-in ND filter and AE functions.

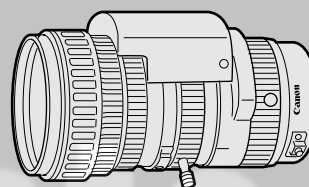
**Extender XL 1.6×**

Attach this extender between a Canon XL lens and the XL1S to boost the focal length of the lens by 1.6×.

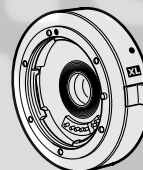
**EF Adapter XL**

This allows you to attach Canon EOS lenses to the XL1S. The difference in size between the XL1S's 1/3" CCD's and 35mm film means that the effective focal length of still camera lenses is multiplied by 7.2×. A 300mm lens, for example, is transformed into an incredible 2,160mm super telephoto.

- Consult your local service outlet to make sure there are no compatibility problems with your chosen lens.

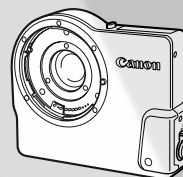
**FU-1000 Monochrome CRT Viewfinder Unit**

Professional quality B&W viewfinder with a 1.5" CRT.

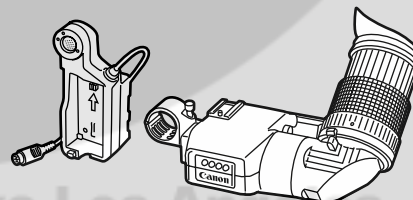
**VL-10Li Battery Video Light**

This compact yet powerful video light can be used for both indoor and outdoor shooting.

- Lithium ion battery packs can be used to power the light. Approximate usage times are as follows:
BP-915 60 min BP-930 120 min
BP-945 170 min

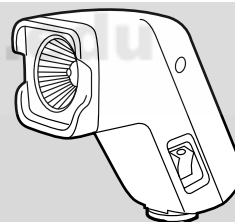

CH-910 Dual Battery Charger/ Holder

This holds two battery packs and can charge them both consecutively.

It can then be connected directly to the XL1S using its DC Coupler to give twice the playback time. It can also make use of the high performance battery pack BP-930, to give up to 3hrs. recording time.

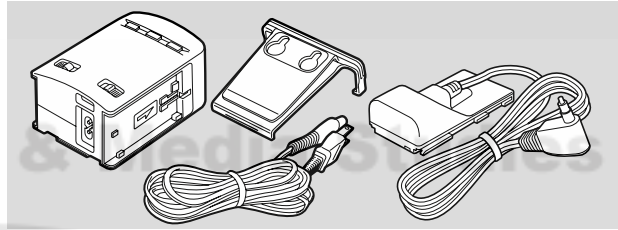

420EX Speedlite

550EX Speedlite

Attaches to the XL1S to give SLR-style flash photography (the optional FA-200 Flash Adapter is also necessary).

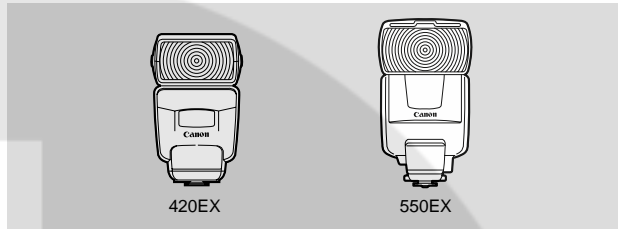

Zoom Remote Controller ZR-1000

When this product is plugged into the LANC terminal of a Canon camcorder, it is possible to control functions such as the start and stop of recording and the zoom and focusing functions while the camcorder is mounted on a tripod, without touching the camcorder body itself.

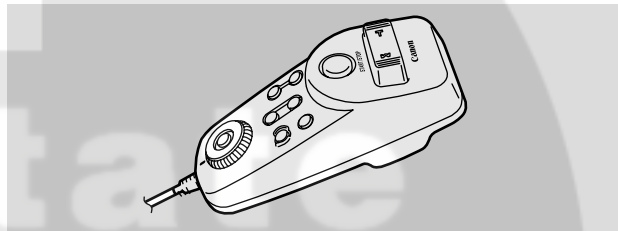

This mark identifies genuine Canon video accessories. When you use Canon video equipment, we recommend Canon-brand accessories or products bearing the same mark.

Provided accessories:

• Body Kit and “ Complete Kit ”:	
WL-D3000 Wireless Controller	D83-0592-000
SS-1000 Shoulder Strap	D81-1220-000
BP-930 Battery Pack	3058A002AA
CA-910 Compact Power Adapter	3025A002AA
DC-900 DC Coupler	3072A002AA
S-150 S-video Cable	3062A002AA
STV-150 Stereo Video Cable	3065A002AA
SP-100 Shoulder Pad	3154A002AA
Body Cap	DA1-8472-000
• “ Complete Kit ” only:	
16× XL IS II 5.5-88mm Zoom Lens	7121A002AA
Lens Hood	YG9-5739-000
Lens Cap	YF1-0008-000
Dust Cap	YA1-1715-000
Lens Soft Case	YA1-1717-000

Optional accessories:

BP-945 Battery Pack	4244A002AA
CB-910 Car Battery Adapter	3035A002AA
CH-910 Dual Battery Charger/Holder	3036A002AA
MA-100 Microphone Adapter/Shoulder Pad	3153A002AA
MA-200 Microphone Adapter/Shoulder Pad	7048A002AA
ZR-1000 Zoom Remote Controller	3089A002AA
FA-200 Flash Adapter	3152A002AA
420EX Speedlite (Flash Unit)	4590A009AA
550EX Speedlite (Flash Unit)	2261A003AA
VL-10Li Battery Video Light	3140A002AA
JR7.2V 10WF Halogen Bulb	3141A002AA
Extender XL 1.6×	3163A002AA
EF Adapter XL	3162A002AA
XL 3.4-10.2mm Zoom Lens	3159A002AA
16× XL 5.4-86.4mm Zoom Lens	7122A002AA
FS-72U Filter Set	3093A002AA
CV-150F DV Cable	3060A002AA
HC-3100 System Case	7049A002AA
DVM-CL DV Cleaning Cassette	3134A002AA
FU-1000 Monochrome CRT Viewfinder Unit	3157A002AA
FU-500 Color Viewfinder Unit	3165A001AA

Screen Displays

E

To display the date and time on a connected TV, press the wireless controller's DATA CODE button when the camera is in VCR mode with a tape loaded.

Press the wireless controller's ON SCREEN button to see the other displays on the TV screen. (The displays appear white on-screen.) They will not be added to any recordings you make with the camera.

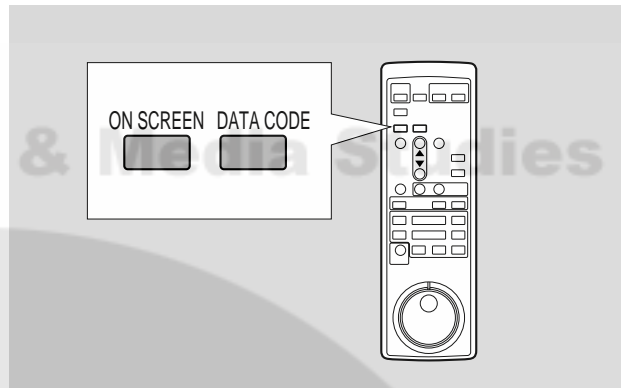



 indicates a flashing display.

Record pause mode (p. 35) 

Recording (p. 35) 

The backup battery is not properly installed, or needs replacing (p. 99). 

Shows how much battery power remains (p. 98). 

The battery pack is exhausted (p. 20, 98). 

No cassette is loaded, or it is set for erasure prevention (p. 23). 

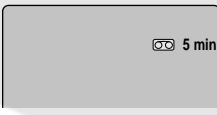
Remaining tape (Green: more than 5 mins. Yellow: less than 5 mins. Red: final few secs). 

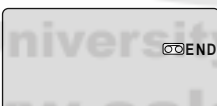
...finally, it tells you when you have completely run out of tape. 

The camera is ejecting the tape (p. 22). 

The safety mechanism is activated. Unload the cassette and turn the camera off. Turn it on again and reload the cassette. 

Recording mode (p. 37) 

Playback is stopped (p. 76). 

Normal playback (p. 76) 

Fast forward (p. 76) 

Rewind (p. 76) 

Fast forward playback (p. 77) 

Rewind playback (p. 77) 

Frame advance playback (p. 78) 

Frame reverse playback (p. 78) 

For instructional use only

For instructional use only

Additional Information

California State University, Dominguez Hills, Los Angeles, CA
www.calstatela.edu



Playback pause (forward and reverse) (p. 77)

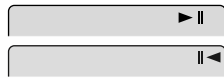

Slow playback (forward and reverse) (p. 78)



×2 playback (forward and reverse) (p. 78)

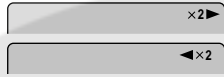

×1 playback (forward and reverse) (p. 78)

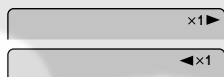
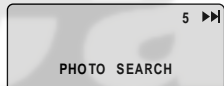

Photo Search (p. 81)



Index Search (p. 81)



AV Insert Editing (p. 90)



Audio Dubbing (p. 93)

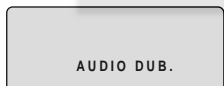

Zoom display (p. 38):
Optical zoom



Optical plus digital zoom

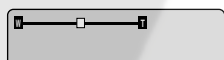

Zoom in

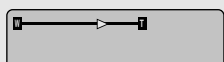

Zoom out

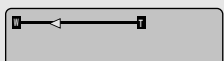

Camera menu (p. 25)

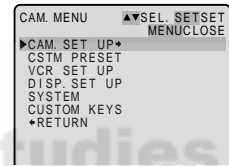

VCR menu (p. 28)

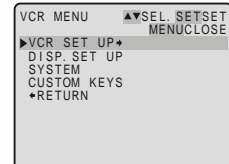

The remote sensor is turned off (p. 31).



Zero set memory (p. 82)

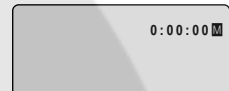

Interval timer recoding (p. 63)



Self-timer countdown (p. 64)

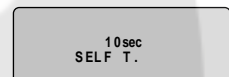

Audio mode (p. 51)

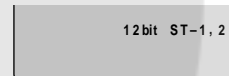

Data code (p. 79)



The camcorder does not have a lens attached



Photo mode (p. 42)

- Setting the AF/AE mark flashes white
- AF/AE locked mark lights up green
- Timer



Movie mode (p. 44)



- Outdoor mode



Recording programs (p. 47).

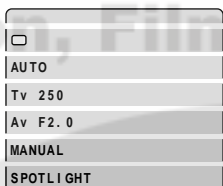

- Indoor mode



Flash is charging
⚡ mark flashes white (p. 60)
or charged



Custom keys (p. 55)
Camera mode



⚡ mark lights up green (p. 60)



VCR mode

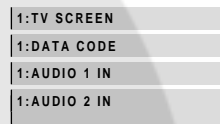

Manual exposure display
(p. 67):
Exposure locked

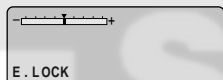

16:9 effect: The display flashes
when the effect is selected;
appears steadily when it is
activated (p. 59).

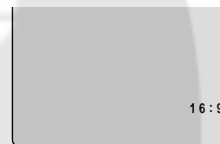

Brighter than standard exposure
level

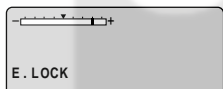

Darker than standard exposure
level

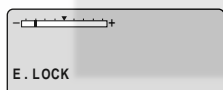

Digital effects and color bars:
The display flashes when the
function is selected; appears
steadily when it is activated (p.
58).

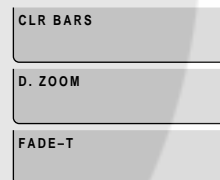

Manual setting of shutter speed,
F number



The iris is closed



The camcorder is recording via
DV terminal (p. 65).



ND Filter (p. 41)

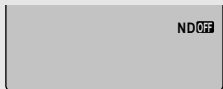

DV control (p. 65)

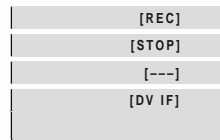

Manual focus is selected
(p. 66).



White balance is set manually
(p. 74).



Recording characters (p. 62)

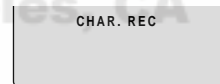

For instructional use only

For instructional use only

Gain (p. 73)

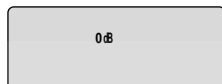

Audio output (p. 96)



Mix balance (p. 96)

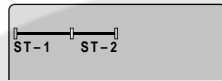

Mix select has not been released at the menu (p. 97)

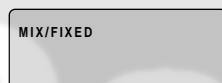

Condensation warning (p. 106)



Time Code

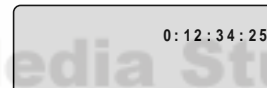

This records counter information, including hour, minute, second, and frame number on a special data code area on the tape itself. It is reset automatically when a new tape is loaded.

Recording reminder

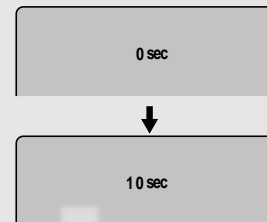

When you start recording, the camera counts from 0SEC to 10SEC. Shots which are shorter than 10 seconds may be difficult to edit later. On the other hand, if you are not planning to edit the recording, remember that a shot which does not contain action should generally last no longer than 10 seconds.

E**Caution phrases**

The camera displays various caution phrases — they appear for 4 seconds before disappearing.

Refer to page 87.

COPYRIGHT PROTECTED
DUBBING RESTRICTED

Appears each time you turn the power on, until you set the time zone, date and time (p. 32).

SET THE TIME ZONE,
DATA AND TIME

Appears when you try to do audio dubbing or AV insert on a tape recorded in any mode other than SP mode(p. 37).

CHECK THE CASSETTE
[REC MODE]

Refer to pages 14-15.

CHECK THE LENS

Appears when you try to do audio dubbing on a tape recorded in 16-bit audio or 12-bit 4-channel mode (p. 88).

CHECK THE CASSETTE
[AUDIO MODE]

Refer to page 35.

ENTERING "POWER STANDBY"

Appears when the battery pack is exhausted (p. 20, 98).

CHANGE THE BATTERY PACK

Appears when the camera detects a blank section of a tape during audio dubbing or AV insert (p. 91).

CHECK THE CASSETTE
[BLANK]

Appears when the tape has reached the end.

TAPE END

Appears immediately after you start recording, and the video heads are badly contaminated. Make sure to clean the video heads when this caution appears (p. 105).

HEADS DIRTY,
USE CLEANING CASSETTE

Refer to page 23.

THE TAPE IS SET FOR
ERASURE PREVENTION

Appears when you press the ● (record) button if the DV cable is not connected properly (p. 65).

CHECK THE DV INPUT

Refer to page 106.

CONDENSATION
HAS BEEN DETECTED

Appears as a warning to protect the tape and also when condensation is detected. Remove the tape as soon as possible after the camera has displayed the caution.

REMOVE THE CASSETTE

Refer to page 87.

COPYRIGHT PROTECTED
PLAYBACK IS RESTRICTED

For instructional use only

For instructional use only

Additional Information

Main LCD panel

Recording mode (p. 37)

Time code (p. 117)

Cassette: set for erasure prevention or not loaded (p. 23)

Tape has reached the end (p. 118)

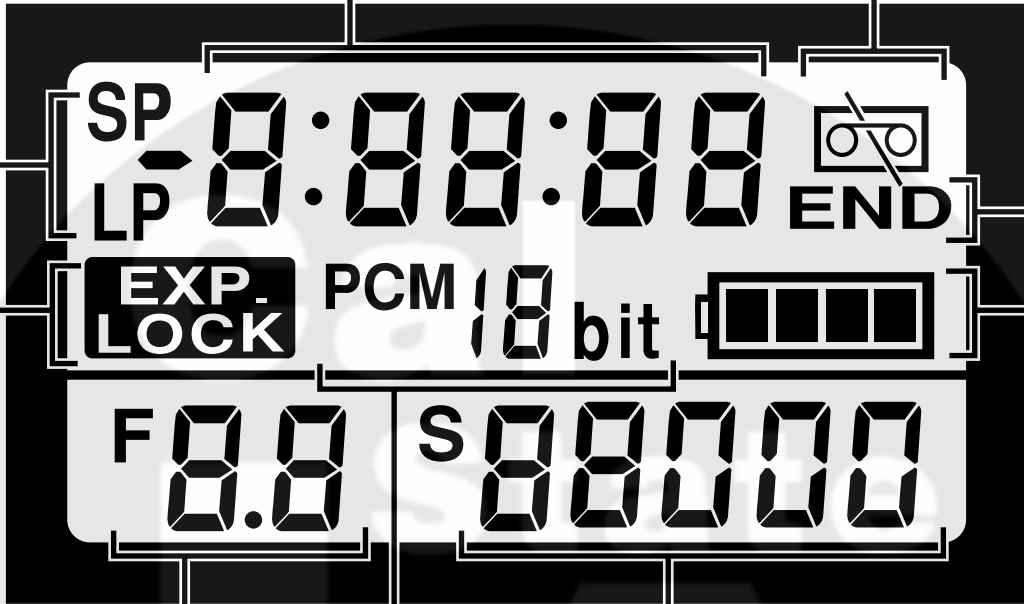

Exposure lock (p. 67)

F number (aperture size) (p. 49)

Audio mode (p. 51)

Shutter speed (p. 49)

Remaining battery power (p. 98)

Audio LCD panel

Manual recording level (p. 49)

Audio mix (p. 96)
• When only PB is shown = 16-bit mode

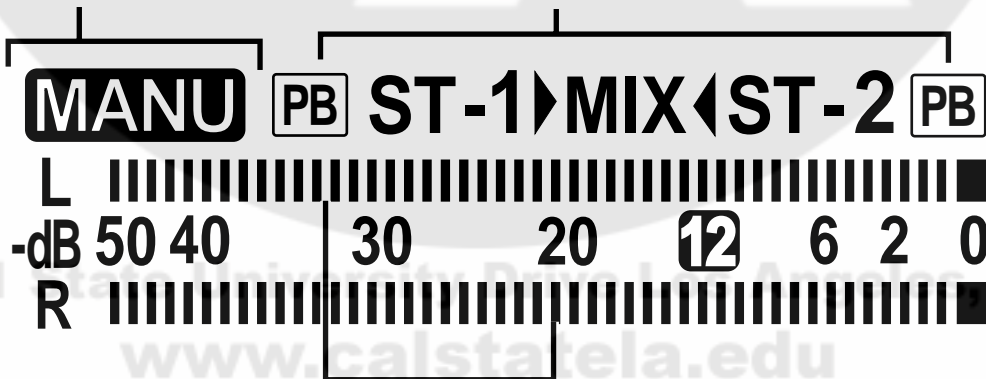

L, R Recording levels (p. 52)

For instructional use only

For instructional use only

Additional Information

Specifications

XL1S

E

Power Supply (rated): 7.2 V DC

Power Consumption (while recording, AF=ON):

8.7 W (Approx., recording with the AF turned on with 16× IS II lens)

Television system:

EIS standard (525 lines, 60 fields) NTSC color signal

Video recording system:

2 rotary heads, helical scanning system
DV system (Consumer digital VCR SD system)
Digital component recording

Audio recording system: PCM digital sound:

16 bit (48kHz/2ch), 12 bit (32kHz/2 from 4ch),
12 bit (32kHz/4ch simultaneous)

Image sensor: 3CCD 1/3" Pixel Shift (charge coupled device) 270,000 pixels
(250,000 effective pixels)

Tape format: Videocassettes bearing the MiniDV mark.

Tape speed:

SP: 3/4 ips (18.81 mm/s);
LP: 1/2 ips (12.56 mm/s)

Maximum recording time:

SP: 80 minutes (with a 80 min. cassette);
LP: 120 minutes (with a 80 min. cassette)

Fast forward/rewind time:

2 mins 20 sec. (with a 60 min. cassette)

Lens mount: XL Interchangeable lens system

Focusing system: TTL autofocus, manual focusing possible

Minimum focusing distance*:

13/16 inch (2cm) on maximum wide angle;
telephoto end: 3ft 4in (1m)

Maximum shutter speed:

1/15,000 sec

Minimum illumination: 2 lx*

(using slow shutter at 1/8 of a second)

Recommended illumination:

More than 100 lx

Filter diameter: 72mm (XL lens)*

Viewfinder: 0.7-inch, color LCD*

(approx. 180,000 pixels)

Microphone: Stereo electret condenser microphone

DV Terminal: Special 4 pin connector (based on IEEE1394)

Output level:

Video terminal: RCA jack, 1 Vp-p/75Ω unbalanced, synchronized load

S-video terminal: 4 pin mini DIN, 1 Vp-p (Y signal), 0.286 Vp-p (C signal)

Audio terminal: RCA jack (L, R), 2 sets 4dBm (47kΩ load)/3kΩ or less, unbalanced

Headphone terminal: φ3.5mm, -25dBV (16Ω load) /120Ω

Input level:

Video terminal: RCA jack, 1 Vp-p/75Ω unbalanced, synchronized load

S-video terminal: 4 pin mini DIN, 1 Vp-p (Y signal), 0.286 Vp-p (C signal)

Audio terminal: RCA jack (L, R), 2 sets -11dBV/47kΩ (LINE), unbalanced

-35dBV/600Ω (MIC ATT), unbalanced

-55dBV/600Ω (MIC), unbalanced

Microphone terminal: φ3.5mm stereo mini-jack, -59dBV (with 600Ω mic)/600Ω

Operating temperature range:

32°–104°F (0°–40°C)

Dimensions: 8 3/4 × 8 7/16 × 16 5/16 in

(223 × 214 × 415 mm)

Weight (not including lens and battery pack):

3 lbs 12 oz approx. (1.7kg)

(fully loaded):

6 lbs 3 oz approx. (2.86kg)

BP-930 Battery Pack

Battery type: Rechargeable lithium ion battery

Rated voltage: 7.2 V DC

Operating temperature: 32°–104°F (0°–40°C)

Battery capacity: 3,000 mAh

Dimensions: 1 1/2 × 1 5/8 × 2 13/16 in

(38.2 × 39.0 × 70.5 mm)

Weight: 6 1/2 oz (185 g)

Weight and dimensions are approximate

Errors and omissions excepted.

Subject to change without notice.

Canon is a trademark of Canon Inc.

* The 16× IS II lens and the color viewfinder:
Complete kit only

For instructional use only

For instructional use only

Additional
Information

University Drive Los Angeles, CA
www.calst

Index

- 16:9, 59
- A** Abroad, Using the Camera, 105
 - Accessories, 111
 - Adapter, AC, 19
 - AE Shift, 68
 - Analog Line-in, 88
 - Audio Dubbing, 93
 - Audio Mode, 51
 - Audio Output, 96
 - Auto, 49
 - Autofocus, 66
 - AV Insert, 90
 - Av Mode, 50
- B** Backup Battery, 99
 - Basic Recording, 35
 - Battery Pack, 20
- C** Camera Mode, 11
 - Cassettes, 22
 - Charging the Battery Pack, 20
 - Choosing a Recording Program, 46
 - Cleaning the Camera, 105
 - Clear Scan, 72
 - Color Bars, 61
 - Color Gain, 69
 - Color Phase, 69
 - Condensation, 106
 - Custom Keys, 55
 - Custom Preset, 69
- D** Date and Time, 32
 - Date Search, 81
 - Displaying Data Code, 79
 - DC Coupler, 19
 - Digital Zoom, 39
 - DV Control, 65
 - DV Dubbing, 86
 - DV Terminal, 65, 86
- E** Easy Recording, 49
 - Edit Search, 77
 - Exposure, 67
- F** Fade, 58
 - Fast Forward, 77
 - Feedback, 83
 - Finding Your Way Around the XL1S, 9
 - Five-minute Timer, 36
 - Flash Photography, 60
 - F Number, 50
 - Focusing, 66
 - Frame Mode, 44
- G** Gain, 73
 - Grip Belt, 24
 - Grip Zoom, 38, 57
- H** Handle Zoom, 38, 57
 - Head Cleaning, 105
 - Headphones, 54
- I** Image Stabilizer, 40
 - Index Write, 56
 - Index Search, 81
 - Interval Timer, 63
 - Introducing the XL1S, 8
 - Iris/Select Dial, 25, 49, 67
- L** LANC, 85
 - LCD Panel, 109
 - Lens Cap, 24
 - Lens Hood, 15
 - Light Button, 9
 - Loading Cassettes, 22
 - Low-angle Recording, 101
 - LP Mode, 37
- M** Maintenance, 104
 - Manual Focus, 66
 - Manual Recording Program, 67
 - Menu, 25
 - Menu at a Glance, 122
 - Microphone, 18
 - Mix Balance, 96
 - Movie Mode, 44
- N** ND Filter, 41
- O** Optional Accessories, 111
- P** Photo Mode, 42
 - Photo Search, 81
 - Playback, 76
 - Playback Pause, 77
 - Power Adapter, 19
 - Powering Your Camcorder, 19
 - Problems, 107
 - Push Autofocus, 66
- R** Recording, 35
 - Recording Level, 52, 53
 - Recording Programs, 46
 - Record Pause Mode, 35
 - Record Review, 45
 - Record Search, 45
 - Remote Control, 30
 - Remote Sensor, 31
 - Rewind, 77
- S** Screen Display, 114
 - Self-timer, 64
 - Setup Level, 69
 - Sharpness, 69
 - Shoulder Pad, 24
 - Shoulder Strap, 24
 - Shutter Speed, 50
 - Sound Check, 54
 - Specifications, 120
 - Speedlite, 60
 - Spotlight, 49
 - SP Mode, 37
 - STANDBY Button, 35
 - Storage, 104
 - Supporting the Camera, 24
 - System Diagram, 110
- T** Tally Lamp, 31
 - Tape Protection, 23
 - Telephoto, 38
 - Temperature, 104
 - Time Code, 117
 - Tripod, 101
 - Troubleshooting, 107
 - Tv Mode, 50
 - TV Screen, 56
- U** Using the Camera Abroad, 105
 - Using the Menu, 25
- V** VCR, 76
 - VCR Stop, 36, 56
 - Videocassettes, 22
 - Video Heads, 105
 - Viewfinder, 13, 16, 105
- W** Wide-angle, 38
 - Wide Screen TV, 59
 - Wireless Controller, 30
 - White Balance, 74
- X** XL Lens, 14
- Z** Zebra Pattern, 56, 71
 - Zero Set Memory, 82
 - Zooming, 38

E

Additional
Information

Menu at a Glance

Use the list below to quickly navigate the camera's menu. Functions are listed alphabetically.

E

Function	First make sure the camera is set to...	Then select it from this submenu and set.
16:9 effect	Camera mode	CAM. SET UP
16:9 guide	Camera mode	DISP. SET UP
6-sec. Date	VCR mode	DISP. SET UP
Audio 1 in	Camera mode	VCR SET UP
Audio 2 in	Camera mode	VCR SET UP
Audio mode	Camera mode	VCR SET UP
Character recording	Camera mode	SYSTEM
Clear Scan	Camera mode	CAM. SET UP
Color gain	Camera mode	CSTM PREST
Color phase	Camera mode	CSTM PREST
Custom key 1	Camera mode	CUSTOM KEYS
Custom key 2	Camera mode	CUSTOM KEYS
Custom keys display	VCR mode	DISP. SET UP
Custom keys guide information	Camera mode	DISP. SET UP
Custom preset number	Camera mode	CSTM PREST
Data code	VCR mode	DISP. SET UP
Date/time select	VCR mode	DISP. SET UP
Date/time set	Camera mode	SYSTEM
Displays	VCR mode	DISP. SET UP
DV control	Camera mode	SYSTEM
Grip zoom speed	Camera mode	CAM. SET UP
Handle zoom speed	Camera mode	CAM. SET UP
Interval timer	Camera mode	VCR SET UP
Mix select	VCR mode	VCR SET UP
Movie mode	Camera mode	CAM. SET UP
Output channel	VCR mode	VCR SET UP
Record mode	Camera mode	VCR SET UP
Remote sensor	Camera mode	SYSTEM
Setup level	Camera mode	CSTM PREST
Sharpness	Camera mode	CSTM PREST
Tally lamp	Camera mode	SYSTEM
Time Zone/DST	Camera mode	SYSTEM
TV screen	Camera mode	DISP. SET UP
VCR stop	Camera mode	VCR SET UP
Viewfinder color	Camera mode	DISP. SET UP
Zebra pattern level	Camera mode	CAM. SET UP
Zebra pattern on/off.	Camera mode	CAM. SET UP

For instructional use only

For instructional use only

Additional Information

U.S.A.

CANON® XL1S DIGITAL VIDEO CAMCORDER LIMITED WARRANTY

The limited warranty set forth below is given by Canon U.S.A., Inc. ("CUSA") with respect to each Canon XL1S Digital Video Camcorder ("DV Camcorder") purchased and used in the United States.

Each Canon DV Camcorder, when delivered to you in new condition in its original container, is warranted against defective material or workmanship as follows: for a period of one (1) year from the date of original purchase (three (3) months in the case of the video head part), defective parts or DV Camcorders returned to a CUSA factory service center ("CUSA Center") or an authorized DV Camcorder service facility ("Service Facility"), and proven to be defective upon inspection, will be repaired or exchanged for new or comparable rebuilt parts or DV Camcorders. The warranty period for repaired or replacement parts or DV Camcorders shall begin upon shipment of the same, but shall in no event exceed the original warranty period of the defective part or DV Camcorder.

Non-Canon brand peripheral equipment and software which may be distributed with Canon DV Camcorders are sold "AS IS", without warranty of any kind by CUSA, including any implied warranty regarding merchantability or fitness for a particular purpose. The sole warranty with respect to such non-Canon brand items is given by the manufacturer or producer thereof.

CUSA shall have no responsibility under this limited warranty for use of Canon DV Camcorders in conjunction with incompatible peripheral equipment and incompatible software.

In order to obtain warranty service, contact the authorized Canon retail dealer from whom you purchased the DV Camcorder or call the CANON INFORMATION CENTER AT 1-800-828-4040 (which is open from 9:00 a.m. to 5:00 p.m. (E.S.T.), Monday through Friday, excluding holidays). Have your unit serial number and your date of purchase available when you make the call to expedite service. In either case you will be directed to ship the DV Camcorder, postage prepaid, to the CUSA Center or Service Facility nearest to you. You must include a copy of the proof of purchase (bill of sale) and a complete explanation of the problem. DV Camcorders covered by this limited warranty will be repaired and returned to you without charge by the CUSA Center or the Service Facility. Repairs not under warranty will be at such cost as the CUSA Center or Service Facility may from time to time generally establish.

This limited warranty covers all defects encountered in normal use of the DV Camcorder, and does not apply in the following cases:

- Loss of or damage to the DV Camcorder due to abuse, mishandling, improper packaging by you, alteration, accident, leaking batteries, exterior nicks, scratches or dents, electrical current fluctuations, failure to follow operating instructions, maintenance and environmental instructions prescribed in CUSA's instruction manual, or service performed by other than a CUSA Center or Service Facility.
- Use of parts or supplies (other than those sold by CUSA) which cause damage to the DV Camcorder or cause abnormally frequent service calls or service problems.
- If any DV Camcorder has had its serial number or dating altered or removed.

This limited warranty does not apply to accessories or consumables for the DV Camcorder, which are sold "AS IS", without warranty of any kind by CUSA.

NO IMPLIED WARRANTY, INCLUDING ANY IMPLIED WARRANTY OF MERCHANTABILITY OR FITNESS FOR A PARTICULAR PURPOSE, APPLIES TO THE DV CAMCORDER AFTER THE APPLICABLE PERIOD OF EXPRESS WARRANTY STATED ABOVE, AND NO OTHER EXPRESS WARRANTY OR GUARANTY, EXCEPT AS MENTIONED ABOVE, GIVEN BY ANY PERSON, FIRM OR CORPORATION WITH RESPECT TO THE DV CAMCORDER SHALL BIND CUSA. (SOME STATES DO NOT ALLOW LIMITATIONS ON HOW LONG AN IMPLIED WARRANTY LASTS, SO THE ABOVE LIMITATION MAY NOT APPLY TO YOU) CUSA SHALL NOT BE LIABLE FOR LOSS OF REVENUES OR PROFITS, EXPENSE FOR SUBSTITUTE EQUIPMENT OR SERVICE, STORAGE CHARGES, LOSS OF DATA, OR ANY OTHER SPECIAL, INCIDENTAL OR CONSEQUENTIAL DAMAGES CAUSED BY THE USE, MISUSE OR INABILITY TO USE THE DV CAMCORDER, REGARDLESS OF THE LEGAL THEORY ON WHICH THE CLAIM IS BASED, AND EVEN IF CUSA HAS BEEN ADVISED OF THE POSSIBILITY OF SUCH DAMAGES. NOR SHALL RECOVERY OF ANY KIND AGAINST CUSA BE GREATER IN AMOUNT THAN THE PURCHASE PRICE OF THE DV CAMCORDER SOLD BY CUSA AND CAUSING THE ALLEGED DAMAGE. WITHOUT LIMITING THE FOREGOING, YOU ASSUME ALL RISK AND LIABILITY FOR LOSS, DAMAGE OR INJURY TO YOU AND YOUR PROPERTY AND TO OTHERS AND THEIR PROPERTY ARISING OUT OF USE, MISUSE OR INABILITY TO USE THE DV CAMCORDER NOT CAUSED DIRECTLY BY THE NEGLIGENCE OF CUSA. (SOME STATES DO NOT ALLOW THE EXCLUSION OR LIMITATION OF INCIDENTAL OR CONSEQUENTIAL DAMAGES, SO THE ABOVE LIMITATION MAY NOT APPLY TO YOU.) THIS LIMITED WARRANTY SHALL NOT EXTEND TO ANYONE OTHER THAN THE ORIGINAL PURCHASER OF ANY DV CAMCORDER, OR THE PERSON FOR WHOM IT WAS PURCHASED AS A GIFT, AND STATES YOUR EXCLUSIVE REMEDY.

This limited warranty gives you specific legal rights, and you may also have other rights which vary from state to state.

Canon U.S.A., Inc.
One Canon Plaza
Lake Success, New York 11042

CANADA

CANON CONSUMER DIGITAL VIDEO EQUIPMENT LIMITED WARRANTY

The limited warranty set forth below is given by Canon Canada Inc. ("Canon Canada") with respect to Canon digital video equipment purchased in Canada. This limited warranty is only effective upon presentation of a bill of sale or other proof of purchase for this Canon digital video equipment to a Canon Service Facility when repairs are required.

Canon consumer video digital equipment is warranted under normal, non-commercial, personal use, against defective materials or workmanship as follows:

Parts: Defective parts will be exchanged for new parts or, at Canon Canada's option, comparable rebuilt parts for a period of one year from the date of original purchase, except Video Heads which will be exchanged for a period of 3 months from the date of purchase.

Labour: For a period of one year from the date of original purchase, labour will be provided free of charge by our Canon Service Facilities in Canada.

This limited warranty covers all defects except where:

- The loss or damage to the product results from:
 - accident, natural disaster, mishandling, abuse, neglect, unauthorized product modification or failure to follow instructions contained in the instruction manual;
 - the use of accessories, attachments, products, supplies, parts or devices with this Canon product that do not conform to Canon specifications or that cause abnormally frequent service problems;
 - repairs or services performed by any party other than a Canon Service Facility;
 - defective batteries or any exposure to water, sand or dirt;
 - shipping (claim must be presented to the shipper);
- Any serial number on the video equipment is altered or removed.
- The digital video equipment is used for commercial, professional or industrial purposes.

This limited warranty does not cover the cabinet (exterior finish) of the digital video equipment, video cassette tapes, head cleanings, nor does it apply to digital video equipment purchased outside Canada.

TO OBTAIN WARRANTY SERVICE

Ship your Canon digital video equipment in its original carton, box or equivalent, properly packed, fully insured with shipping charges prepaid, together with a copy of your bill of sale or other proof of purchase and a description of the problem to any of the Canon Service Facilities in Canada.

LIMITATIONS

Except as otherwise required by applicable legislation, this warranty is in lieu of all other warranties, conditions, guarantees or representations, express or implied, statutory or otherwise, relative to this Canon product, including implied warranties or conditions of merchantability or fitness for a particular purpose.

Canon Canada assumes no liability for special, consequential or incidental damages or loss that may arise, whether on account of negligence or otherwise, from the use, misuse or inability to use this Canon product (including loss of profit, revenue, video tapes or enjoyment) or from failure to conform to any express or implied warranties, conditions, guarantees or representations. Any recovery under this limited warranty shall not exceed the purchase price of the product. Canon Canada does not assume or authorize any other person to assume for Canon Canada any other liability with respect to this Canon product.

This warranty does not extend to any person other than the original purchaser of this Canon product or the person for whom it was purchased as a gift and states your exclusive remedy.

NOTICE TO CONSUMER

If you plan to take important videos or if the product has not been used for some time, please check all functions with the instruction book before using it.

123

E

**Additional
Information**



Television, Film, & Media Studies

CANON INC.

U.S.A. ————— **CANON U.S.A., INC. NEW JERSEY OFFICE**
100 Jamesburg Road, Jamesburg, NJ 08831 USA

CANON U.S.A., INC. CHICAGO OFFICE
100 Park Blvd., Itasca, IL 60143 USA

CANON U.S.A., INC. LOS ANGELES OFFICE
15955 Alton Parkway, Irvine, CA 92618 USA

CANON U.S.A., INC. HONOLULU OFFICE
1020 Auahi Street, Bldg. #8, Honolulu, HI 96814 USA

- If you have any questions, call the Canon U.S.A. Information Center toll-free at 1-800-828-4040 (U.S.A. only).

CANADA ————— **CANON CANADA INC. NATIONAL HEADQUARTERS**
6390 Dixie Road, Mississauga, Ontario L5T 1P7

CANON CANADA INC. CALGARY
2828, 16th Street, N.E. Calgary, Alberta T2E 7K7

CANON CANADA INC. MONTREAL
5990 Côte de Liesse, Quebec H4T 1V7

- If you have any questions, call the Canon Canada Information Center toll-free at 1-800-828-4040. (Canada only)

- Si vous avez des questions, veuillez téléphoner sans frais au Canada 1-800-828-4040. (Canada seulement)

MEXICO ————— **CANON MEXICANA, S. DE R.L. DE C.V.**
Periferico Sur No. 4124 Col. Ex-Rancho de Anzaldo C.P. 01900
México, D.F., México

CENTRO Y SURAMÉRICA ————— **CANON LATIN AMERICA, INC.**
6505 Blue Lagoon Drive Suite 325 Miami FL 33126 USA

ASIA ————— **CANON HONGKONG COMPANY LTD.**
9/F, The Hong Kong Club Building, 3A Chater Road, Central, Hong Kong

5151 State University Drive Los Angeles, CA

www.canon.com
www.canon.com/stela.edu



Printed on 70% reused paper.
Document réalisé avec du papier recyclé à 70%.
El papel aqui utilizado es 70% reciclado.

Free Manuals Download Website

<http://myh66.com>

<http://usermanuals.us>

<http://www.somanuals.com>

<http://www.4manuals.cc>

<http://www.manual-lib.com>

<http://www.404manual.com>

<http://www.luxmanual.com>

<http://aubethermostatmanual.com>

Golf course search by state

<http://golfingnear.com>

Email search by domain

<http://emailbydomain.com>

Auto manuals search

<http://auto.somanuals.com>

TV manuals search

<http://tv.somanuals.com>