

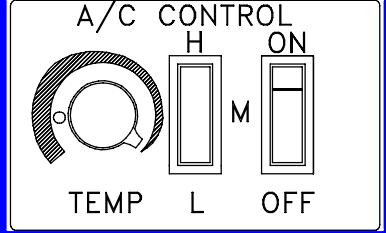

Transport Air Conditioning

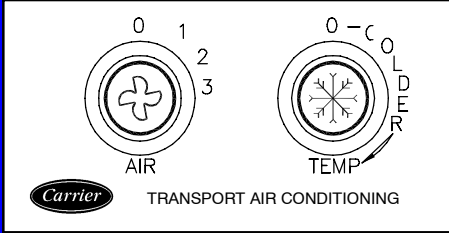

OPERATOR'S MANUAL

for

SPLIT SYSTEM

Bus Air Conditioning Units

T-326 Rev -



TRANSICOLD

OPERATOR'S MANUAL

**BUS AIR CONDITIONING
UNITS
GEN IV & GEN V**

CONTENTS

	Page
Introduction	1
Safety	3
Unit/System Information	4
1.1 WHAT IS AIR CONDITIONING	4
1.2 SPLIT SYSTEM	4
1.3 SYSTEM DESIGNATIONS	4
1.4 SYSTEM COMPONENTS	4
1.5 MODEL AND SERIAL NUMBER TAGS	6
1.6 SYSTEM REQUIREMENTS LABEL	8
Unit Operation	9
2.1 OPERATING INSTRUCTIONS	9
2.2 DRIVER'S CONTROL PANEL - STANDARD .	9
2.3 DRIVER'S CONTROL PANEL - FLORIDA ...	10
2.4 PRE-TRIP INSPECTION	12
System Maintenance	13
3.1 Maintenance Schedule	13
3.2 Warranty/Service	14
Index	Index 1

INTRODUCTION

SPLIT SYSTEM OPERATOR'S MANUAL

This guide has been prepared for the operator of Carrier Transport Air Conditioning systems. It contains basic instructions for the daily operation of the air conditioning system as well as safety information, and other information that will help you to maintain a comfort level for your self and your passengers. Please take the time to read the information contained in this booklet and refer to it whenever you have a question about the operation of your Carrier Transport Air Conditioning system.

More comprehensive information can be found in the Split System Operation and Service Manual (T-299). This manual can be obtained from your Carrier Transport A/C dealer.

Your air conditioning system has been engineered to provide long, trouble-free performance when it is properly operated and maintained. A comprehensive maintenance program will help to insure that the unit continues to operate reliably. Such a maintenance program will also help to control operating costs, increase the unit's working life, and improve performance.

Some Vehicles may require information from manuals supplied by the vehicle manufacturer or other special equipment suppliers. We urge you to review all these publications carefully. This will help you enjoy safe and trouble-free operation of your vehicle.

When having your unit serviced, be sure to specify genuine Carrier Transicold replacement parts for the highest quality and best reliability.

Carrier Transport Air Conditioning Dealers know your vehicle air conditioning system best and will ensure your complete satisfaction. To find the Dealer nearest you, go to www.transportaircon.carrier.com and click on "Dealer Locator", or refer to the Carrier **Bus Stop** Dealer Directory (62-10810) or contact the Carrier Transport Air Conditioning Technical Service Hot-Line 1 (800) 450-2211.

At Carrier Transport Air Conditioning, we are continually working to improve the products that we build for our customers. As a result, specifications may change without notice.

SAFETY

Your Carrier Transport Air Conditioning system has been designed with the safety of the operator in mind. During normal operation, all moving parts are fully enclosed to help prevent injury. During all pre-trip inspections, daily inspections, and problem troubleshooting, you may be exposed to moving parts; please stay clear of all moving parts when the unit is in operation.



WARNING

Beware of unannounced starting of the unit. The unit may cycle the fans and operating compressor unexpectedly as control requirements dictate. Turn system off and disconnect battery power.

REFRIGERANT

The refrigerant contained in the air conditioning system can cause frostbite, severe burns, or blindness when in direct contact with the skin or eyes. For this reason, and because of legislation regarding the handling of refrigerants during system service, we recommend that, whenever your unit requires service of the refrigeration system, you contact your nearest Carrier Transport Air Conditioning authorized dealer for service.

UNIT/SYSTEM INFORMATION

1.1 WHAT IS AIR CONDITIONING

Air Conditioning is the cooling, heating, dehumidification, and filtration of the air within the passenger compartment of a vehicle.

1.2 SPLIT SYSTEM

A Split System normally includes an Evaporator(s), a Condenser(s), a Compressor(s) and interconnecting refrigerant hoses, fittings, and electrical harnesses and controls. A listing of the system components, along with specific data for each, is provided in Paragraph 1.4.

1.3 SYSTEM DESIGNATIONS

Tie-In System - Is a Carrier evaporator and condenser connected to an existing OEM compressor and dash evaporator. The OEM radiator type condenser is normally removed.

Max System - A Carrier system installed along with an existing OEM system. The systems operate independent of each other.

Stand-Alone (Standard) System - All Carrier components installed on a vehicle. These can be either single or dual compressor systems.

1.4 SYSTEM COMPONENTS (Refer To Figure 1-1)

Return Air Thermostat/Sensor - The system may be supplied with a thermostat or thermistor. Both of these devices are temperature sensitive components which when activated, signals the Electro-Magnetic Clutch to engage/disengage. The return air thermostat is normally located in the drivers control panel while the return air thermistor is normally located in the return air flow of the evaporator assembly.

Electro-Magnetic Clutch - The Electro-Magnetic clutch controls the operation of the compressor. When engaged, the compressor circulates refrigerant and provides cooling.

Compressor - The compressor is a belt driven, high-pressure pump, which circulates the refrigerant through the evaporator and condenser. The operation of the compressor is controlled by the Electro-Magnetic clutch.

Condenser - The condenser is normally located in the skirt or on the roof of the vehicle. Its primary function is to reject heat, which was transferred to the refrigerant by the evaporator from the passenger compartment of the vehicle.

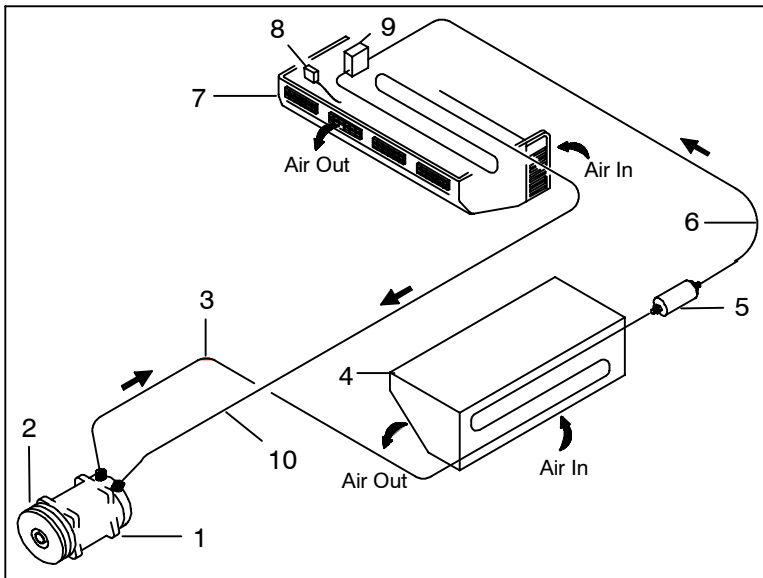

- | | |
|--------------------------------------|---|
| 1. Compressor | 6. Liquid Line |
| 2. Electro-Magnetic Clutch | 7. Evaporator |
| 3. Discharge Line | 8. Block Valve (TXV) |
| 4. Condenser | 9. Freezestat-(Coil freeze-up thermostat) |
| 5. Filter Dryer/Sight Glass Assembly | 10. Suction Line |

Figure 1-1 Component Locations

Filter/Dryer - The filter/dryer removes moisture and particulate matter from the refrigerant.

Expansion/Block Valve - Meters the refrigerant flow into the evaporator coil. The majority of the Gen 4 (Excel) and all Gen 5 systems use a nonadjustable block valve with an 8° F superheat setting, which is preset at the factory. If you feel there is a problem with the block valve, do not attempt to adjust the valve, if needed, it should be replaced by an authorized Carrier Transport A/C service center.

Evaporator - The evaporator is located in the interior of the vehicle. Its primary function is to transfer heat contained in the passenger compartment air, into the refrigerant, which is circulated by the compressor, through the evaporator coil. During this process the air is also filtered and dehumidified.

Resistor - Resistors are used to control the speeds of the permanent magnet evaporator blower motors.

Pressure Switch - The systems use high and low pressure switches wired in series to control the power circuit of the compressor clutch relay. If either pressure switch opens, interrupting the circuit to the clutch relay, the operation of the compressor will stop. When conditions return to normal the switch will automatically reset and the compressor will resume operating. The switches are non-adjustable.

Freeze-Up Thermostat - Freeze-up thermostats are used to prevent ice formation on the evaporator coil, which is an indication that liquid refrigerant is getting back to the compressor. Carrier Transport Air Conditioning systems use a freeze thermostat (freezestat) wired in series with the system pressure switches and thermostat/thermistor to control the operation of the compressor clutch.

Refrigerant - A refrigerant is a material that is used to move heat from the passenger compartment to the outside air. It is a substance that gives up heat by condensing at high temperature and pressures and absorbs heat by evaporating at low temperatures and pressures. The heat transfer properties exhibited when refrigerant changes state is the foundation of the refrigerant cycle.

1.5 MODEL AND SERIAL NUMBER TAGS

In order to identify the air conditioning components you have, you will need to know the model number and serial number. All Carrier Transport Air Conditioning evaporators, condensers and compressors have a model/serial number tag located on the assembly. See Figure 1-2 for skirt mounted condenser data tag location, Figure 1-3 for the CM-7/11 rooftop condensers data tag location, Figure 1-4 for GEN 4 (Excel) evaporator data tag location and Figure 1-5 for GEN 5 evaporator data tag location. Knowing these locations and the information on the data tags will aid you in identifying the correct service procedures.

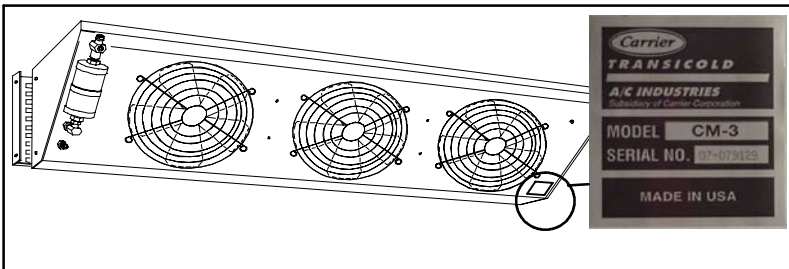

Figure 1-2 Skirt Mounted Condensers

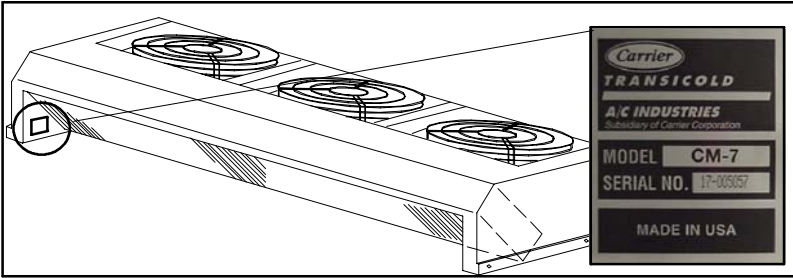

Figure 1-3 Roof Mounted Condensers

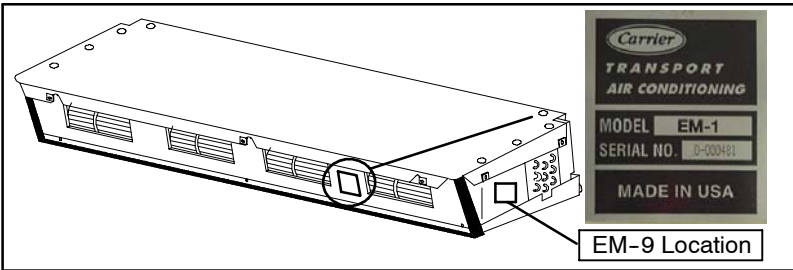

Figure 1-4 Rear/Side Mounted Gen IV Evaporators

NOTE

The EM-9 evaporator data tag is located on the side of the evaporator assembly, not between the blower assemblies.

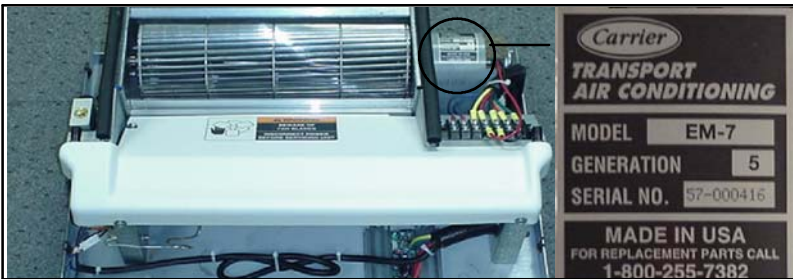

Figure 1-5 Rear/Side Mounted Gen V Evaporators

1.6 SYSTEM REQUIREMENTS LABEL

The system requirements label (See Figure 1-6) is conveniently located within the vehicle's engine compartment. This label, when properly completed by the installer, will give the servicing technician the refrigerant and oil charge(s), evaporator(s), condenser(s), and compressor(s) serial numbers, the drive belt(s) number, mount kit number, the date of installation and the installer.

	AIR CONDITIONING SYSTEM	SERVICE 1-800-450-2211
		PARTS 1-800-255-7382
SER. NOS.?	COMP. #1 <u>C090833</u>	#2 <u>C090936</u>
EVAP. #1 <u>51-004120</u>	#2 <u>51-00448</u>	#3 _____
COND. #1 <u>107-480187</u>	#2 <u>07-080188</u>	
REFRIGERANT TYPE R- <u>134a</u>	#1-QTY. <u>5</u> LBS. <u>5</u> OZ.	#2-QTY. <u>5</u> LBS. <u>9</u> OZ.
OIL TYPE <u>PAG-SANDEN</u>	#1-QTY. <u>11</u> OZ.	#2-QTY. <u>11.8</u> OZ.
BELT NO. CURB SIDE <u>12455</u>	MOUNT KIT NO.	
BELT NO. ROAD SIDE <u>601-227</u>	<u>050-169</u>	
INSTALLER <u>THE BUS CO.</u>	DATE <u>11-27-05</u>	

Figure 1-6 System Requirement Label

UNIT OPERATION

2.1 OPERATING INSTRUCTIONS

Before attempting to operate the system, power must be available from the vehicle battery. If the engine is not running, start the engine. Most systems will not operate unless a signal is received to the controller from the vehicle ignition.

Carrier Transport Air Conditioning system's can be supplied with two different type manual controls. the Standard Manual Control and the Florida Control

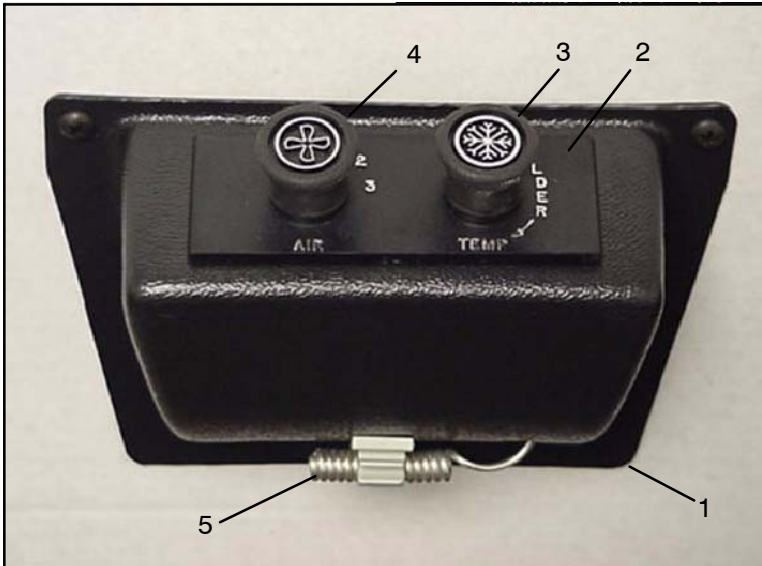

- | | |
|----------------------------------|---|
| 1 Control Panel Housing | 4 Fan Speed Switch
(3 Speed or Variable) |
| 2 Nameplate (Switch
Mounting) | 5 Ambient Air Sensor
(Thermostat) |
| 3 Thermostat Control | |

Figure 2-1 Drivers Control Panel - Standard

2.2 DRIVER'S CONTROL PANEL - STANDARD

The standard Drivers Control Panel (See Figure 2-1), consists of an evaporator fan speed switch (three speed or variable) and an adjustable thermostat. The drivers control panel is normally located within easy reach of the driver. On larger bus applications there could be two separate air conditioning system driver control panels. One for each system.

There will be some applications where the switch mounting plate, thermostat and fan speed switch are mounted in the drivers area without the control panel housing.

On other applications the vehicle manufacturer (OEM) will supply different type controls for the air conditioning system. Refer to OEM technical manual for operating instructions.

2.2.1 Fan Speed Switch (three speed or variable)

Turning this switch clockwise will energize the evaporator and condenser fan motors. The compressor clutch will also be energized if the thermostat calls for cooling (see thermostat control operation).

Three Speed - The standard fan speed switch has four settings, Off (0), Low (1), Medium (2), and High (3) speed operation. This switch controls the operation of the system and the evaporator blower(s) by energizing the appropriate circuits and relays located on the electrical control panel.

Variable Speed - Certain applications may be fitted with a variable speed control switch instead of the standard three speed switch. This switch controls the speed of the evaporator motors by varying the supply voltage.

2.2.2 Thermostat Control

The thermostat controls the temperature within the passenger compartment by switching system components on and off.

Rotate the potentiometer switch knob to the right (clockwise) for maximum cooling. Rotate the potentiometer switch knob to the left (counterclockwise) for less cooling.

2.3 DRIVER'S CONTROL PANEL - FLORIDA (TEMPCON)

This control panel (See Figure 2-2) is normally used in school buses located within the state of Florida, but not limited to that area. This controller is wired to an electrical control board.

The controller consists of:

- a. ON/OFF Switch
- b. Fan Speed Switch
- c. Potentiometer
- d. In-Line Fuse (Behind Controller)

2.3.1 ON/OFF Switch

Power is supplied to the controller, through an in-line fuse (see Figure 2-3) from a 12 VDC ignition source originating from the vehicle. The controller will not operate until the ignition switch is activated.

Move the ON/OFF switch to the ON position. A green light will illuminate indicating that the controller has power. At the same time the evaporator fans will operate in either Low, Medium or High speed, depending on the Fan Speed switch location.

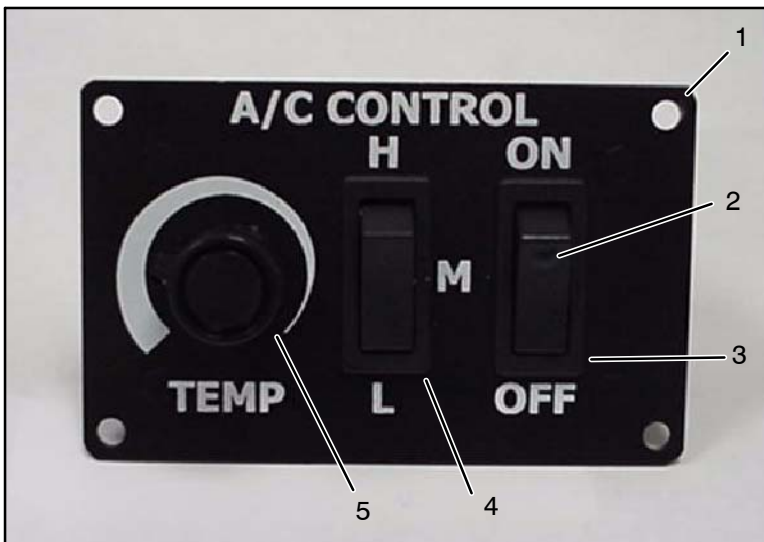

- 1 Face Plate
- 2 Green Light
- 3 Rocker Switch, 2 Position, ON/OFF
- 4 Rocker Switch, 3 Position, LOW-MED-HIGH
- 5 Thermostat Control (Potentiometer)

Figure 2-2 Switch Assembly (TEMPCON)

2.3.2 Fan Speed Switch - 3 Speed

The evaporator fan speeds can be adjusted by pushing the rocker switch to the desired position:

- a. H = High Speed
- b. M = Medium Speed
- c. L = Low Speed

When the evaporator fan speed switch is positioned at the desired speed, a signal is sent to the corresponding fan speed relay located on the electrical circuit board.

2.3.3 Thermostat Control

The thermostat control potentiometer has an operating range of 60 to 85 degrees F.

Rotate the potentiometer switch knob to the right (clockwise) for maximum cooling. Rotate the potentiometer switch knob to the left (counterclockwise) for less cooling.

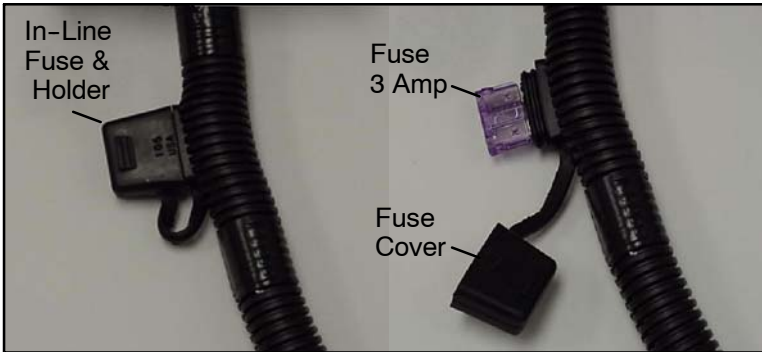

Figure 2-3 In-Line Fuse & Holder (3 Amp)

2.3.4 In-line Fuse

The controller is protected by a 3 Amp ATO type in-line fuse (Figure 2-3). To replace the fuse do the following:

- a. Make sure ignition power is off.
- b. Grasp fuse cover at finger grips and lift off cover.
- c. Remove fuse and check if fuse is defective.
- d. Replace if needed.
- e. Push fuse cover back on to in-line holder.
- f. Restore ignition power and place ON/OFF switch to ON.

2.4 PRE-TRIP INSPECTION

After starting system operation, allow system to stabilize for ten to fifteen minutes and check for the following:

1. Listen for abnormal noises from the vehicle engine, evaporator and condenser areas.
2. Ensure evaporator and condenser fans are operating.
3. Ensure water is not dripping from the evaporator or air ducts.
4. Check for reduced airflow. This is normally caused by dirty or clogged evaporator filters.

SYSTEM MAINTENANCE

3.1 MAINTENANCE SCHEDULE

SYSTEM		OPERATION
ON	OFF	
a. Daily Maintenance		
X	X	Pre-trip inspection - after starting. (Refer to paragraph 2.4)
	X	Check tension and condition of drive belts.
b. Weekly Maintenance		
	X	Perform daily inspection
	X	Check condenser, evaporator coils and return air filters for cleanliness
c. Monthly Maintenance		
	X	Perform weekly inspection
	X	Clean or replace Evaporator return air filters
	X	Inspect Condenser coil fins - Clean when necessary
	X	Inspect refrigerant hoses and fitting connections.
X		Inspect electrical harness and connections
		Check battery voltage - System operates efficiently at 13.5 volts
d. Quarterly Inspection		
	X	Inspect Evaporator(s) coil fins (heater coil if installed) Clean if needed.
X		Check blower operation.
X		Check current draw and voltage of system components including fan motors.
	X	Check that all compressor mounting brackets and hardware are tight. Tighten and torque to proper specifications.
	X	Check hose and harness under vehicle for proper support and protection
	X	Check Evaporator drain lines.

SYSTEM		OPERATION (Continued)
ON	OFF	
e. Semi-Annual Inspection and Maintenance		
X		Check system pressures.
X		Check refrigerant in sight glass.
	X	Check element in the the sight glass. (Green is dry - Yellow is wet)
	X	Inspect condenser fan blades.
	X	Open bus heater valves (In winter).
	X	Close bus heater valves (In spring).
	X	Remove or install optional condenser winter guard kit.
f. Annual Inspection and Maintenance		
	X	Inspect electrical panel and terminals. Clean if needed with a high-grade cleaner specifically formulated for this purpose.
	X	Inspect Evaporator drain pan. (Clean if needed)
X		Check pressure switch operation.
	X	Check evaporator roof mounting and sealing.
	X	Check condenser mounting, fan guards, and screen/grill.

3.2 WARRANTY/SERVICE

Thank you for choosing a Carrier Transport Air Conditioning system for your vehicle. We want to assure you of our continuing interest in your pleasure and satisfaction with your air conditioning system. Remember, if you have a question or concern and need help, contact your nearest Transport Air Conditioning Dealer.

To find the Carrier Transport Dealer nearest you, go to www.transportaircon.carrier.com and click on "Dealer Locator", or refer to the Carrier **Bus Stop** Dealer Directory (62-10810), or contact the Carrier Transport Air Conditioning Technical Service Hot-Line 1 (800) 450-2211. for the center nearest you.

INDEX

C

Clutch - Electro-Magnetic, 4
Compressor, 4
Condenser, 4
Control Panel - Florida, 10
Control Panel - Standard, 9

E

Evaporator, 5

F

Filter/Dryer, 5
Fuse, In-Line, 12

I

Introduction, 1

M

Maintenance Schedule, 13
Max System, 4
Model Tag, 6

O

Operating Instructions, 9

P

Pre-Trip Inspection, 12

R

Refrigerant, 3, 6
Resistor, 5

S

Safety, 3
Sensor - Return Air, 4
Serial Tag, 6
Split System, 4
Stand-Alone System, 4
Switch - Fan Speed, 10, 11
Switch - ON/OFF, 10
Switch - Pressure, 6
System Components, 4
System Designations, 4
System Maintenance, 13
System Label, 8

T

Thermostat - Freeze-Up, 6
Thermostat - Return Air, 4
Thermostat Control, 10, 11
Tie-In System , 4

INDEX (CONTINUED)

U

Unit Information, 4

Unit Operation, 9

V

Valve - Expansion/Block, 5

W

Warranty/Service, 14

What Is Air Conditioning, 4

Carrier Transport Air Conditioning
50 Grumbacher Road
York PA 17402 U.S A
Tel: 1-800-673-2431
Fax: 1-717-764-0401



Carrier

A United Technologies Company

Carrier Transicold Division,
Carrier Corporation
Transport Air Conditioning Group
P.O. Box 4805
Syracuse, N.Y. 13221 U.S A

www.carrier.transicold.com



TRANSICOLD A member of the United Technologies Corporation family. Stock symbol UTX
©2005 Carrier Corporation • Printed in U. S. A. 0605

Free Manuals Download Website

<http://myh66.com>

<http://usermanuals.us>

<http://www.somanuals.com>

<http://www.4manuals.cc>

<http://www.manual-lib.com>

<http://www.404manual.com>

<http://www.luxmanual.com>

<http://aubethermostatmanual.com>

Golf course search by state

<http://golfingnear.com>

Email search by domain

<http://emailbydomain.com>

Auto manuals search

<http://auto.somanuals.com>

TV manuals search

<http://tv.somanuals.com>