

ELECTRONIC CASH REGISTER

TK-7000/7500

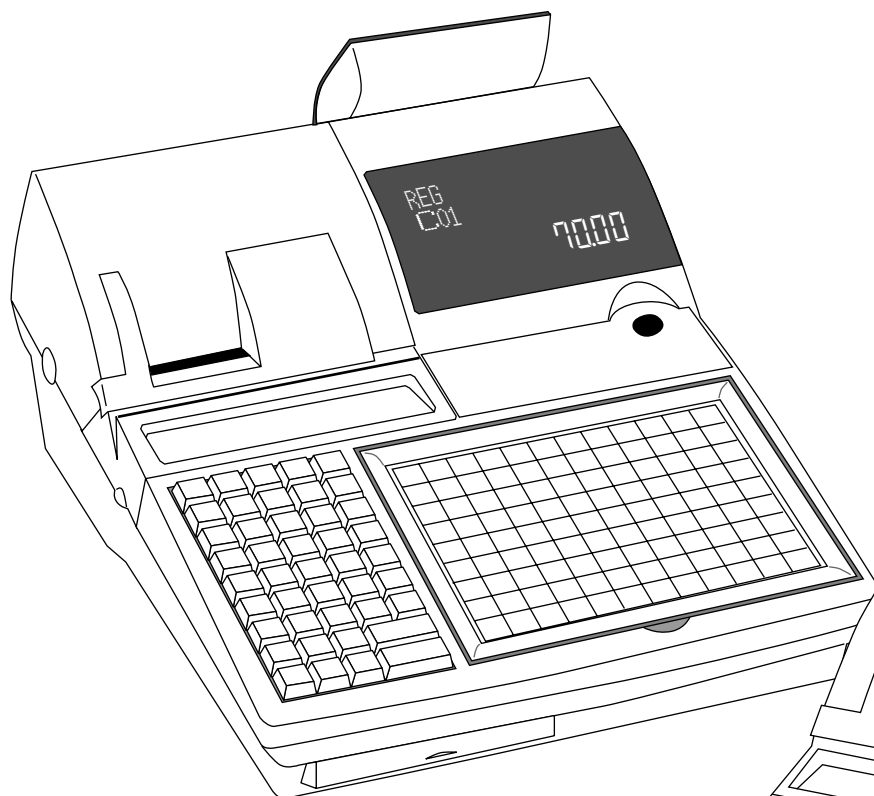

APPLE-
PIE
COFFEE

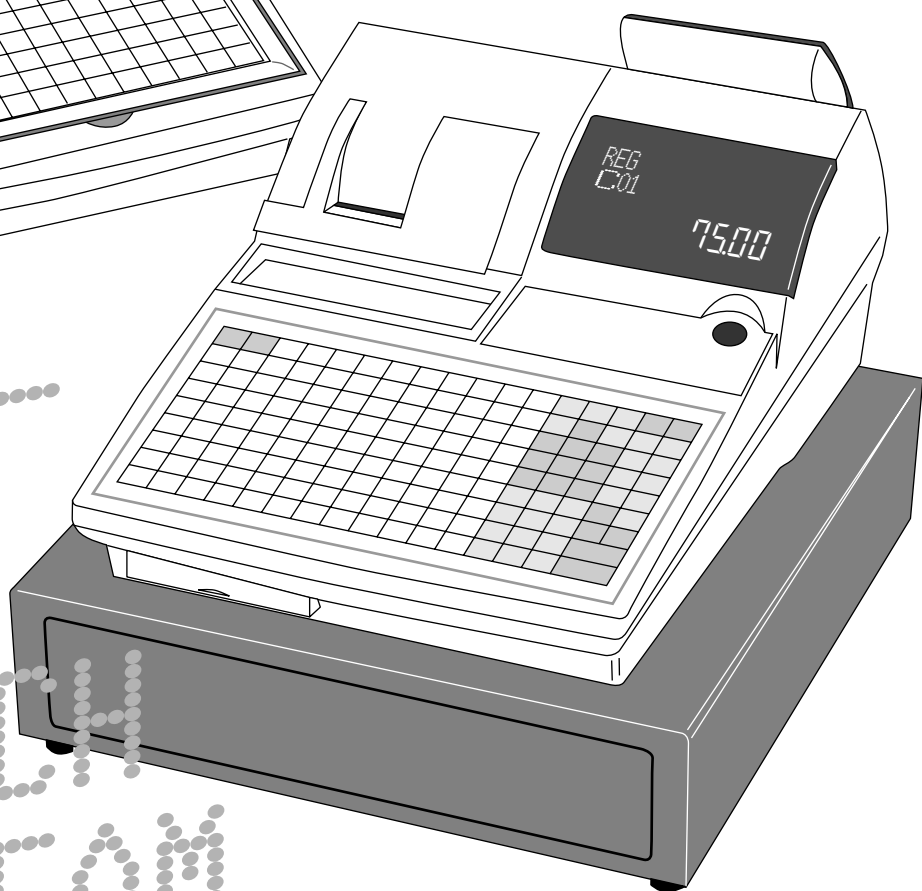

FRENCH-
FRIED
SANDWICH
ICE CREAM

Eu Di U.K.
Cl Canada

USER'S MANUAL

CASIO

Introduction

Congratulations on your selection of a CASIO TK-7000/7500 series electronic cash register. This ECR is the product of the world's most advanced electronic technology, for outstanding versatility and reliability. Simplified operation is made possible by a specially designed keyboard layout and a wide selection of automated, programmable functions.

A specially designed keyboard layout and a bright, easy-to-read display help to take the fatigue out of long hours operation.

Notes for TK-7000/7500-1



Casio Electronics Co., Ltd.
Unit 6, 1000 North Circular Road
London NW2 7JD, U.K.

Please keep all information for future reference.

Notes for TK-7000/7500

GUIDELINES LAID DOWN BY FCC RULES FOR USE OF THE UNIT IN THE U.S.A. (Not applicable to other areas)

WARNING: This equipment has been tested and found to comply with the limits for a Class A digital device, pursuant to Part 15 of the FCC Rules. These limits are designed to provide reasonable protection against harmful interference when the equipment is operated in a commercial environment. This equipment generates, uses, and can radiate radio frequency energy and, if not installed and used in accordance with the instruction manual, may cause harmful interference to radio communications. Operation of this equipment in a residential area is likely to cause harmful interference in which case the user will be required to correct the interference at his own expense.

This digital apparatus does not exceed the Class A limits for radio noise emissions from digital apparatus as set out in the Radio Interference Regulations of Canadian Department of Communications.

The main plug on this equipment must be used to disconnect mains power. Please ensure that the socket outlet is installed near the equipment and shall be easily accessible.

Important!

Your new cash register has been carefully tested before shipment to ensure proper operation. Safety devices eliminate worries about breakdowns resulting from operator errors or improper handling. In order to ensure years of trouble-free operation, however, the following points should be noted when handling the cash register.

Do not locate the cash register where it will be subjected to direct sunlight, high humidity, splashing with water or other liquids, or high temperature (such as near a heater).

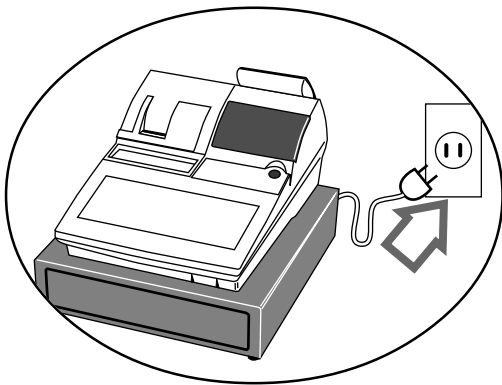
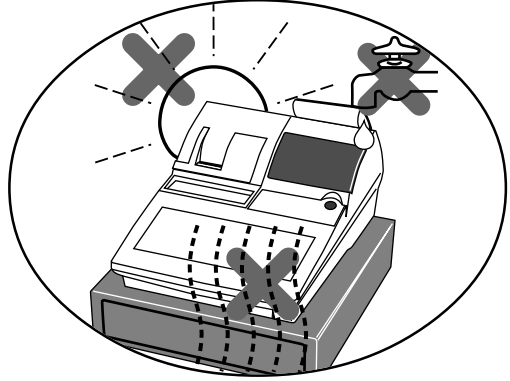

Be sure to check the sticker on the side of the cash register to make sure that its voltage matches that of the power supply in the area.

Never operate the cash register while your hands are wet.

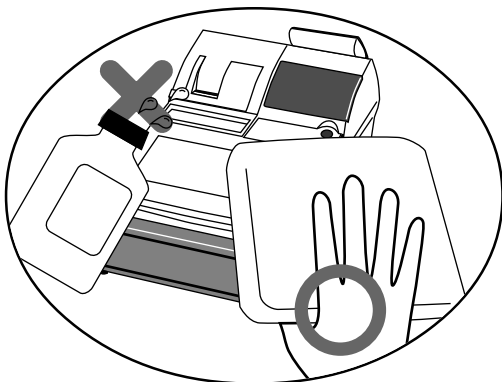
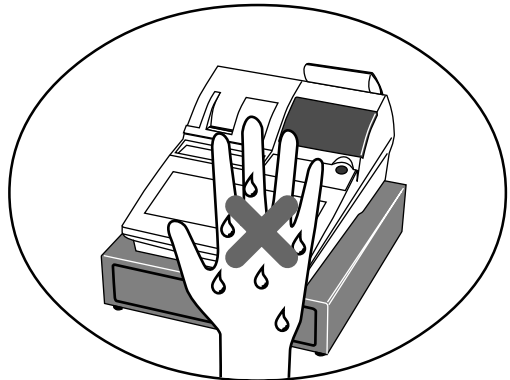

Use a soft, dry cloth to clean the exterior of the cash register. Never use benzene, thinner, or any other volatile agent.

Never try to open the cash register or attempt your own repairs. Take the cash register to your authorized CASIO dealer for repairs.

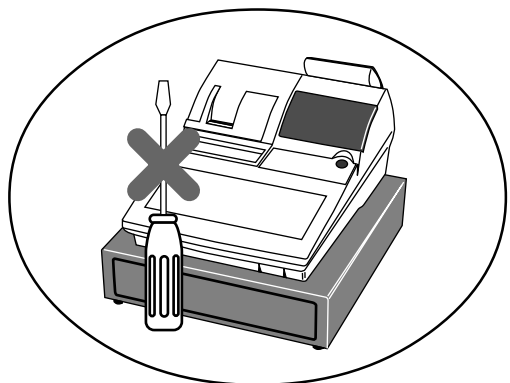

Introduction & Contents

Introduction & Contents	2
Remove the cash register from its box.	8
Remove the tape holding parts of the cash register in place.	8
Remove the cash drawer from its box.	8
Connect the drawer.	8
Getting Started	8
Mount the cash register.	9
Plug the cash register into a wall outlet.	9
Insert the mode key marked "OW" into the mode switch.	9
Install receipt/journal paper.	10
Set the date.	12
Set the time.	12
Introducing TK-7000/7500	14
General guide	14
Display	18
Keyboard (TK-7000)	20
Keyboard (TK-7500)	22
Allocatable functions.....	24
How to remove/replace the sheet holder (TK-7000 only)	26
How to install a menu sheet in the sheet holder (TK-7000 only)	27
Basic Operations and Setups	28
How to read the printouts	28
How to use your cash register	29
Assigning a clerk	30
Clerk button	30
Clerk lock/clerk key.....	30
Clerk secret number key	30
Displaying the time and date	31
To display and clear the date/time.....	31
Preparing coins for change.....	31
Preparing and using department/flat-PLU keys	32
Registering department/flat-PLU keys.....	32
Programming department/flat-PLU keys	33
To program a unit price for each department/flat-PLU	33
To program the tax calculation status for each department/flat-PLU	33
To program high amount limit for each department/flat-PLU	34
Registering department/flat-PLU keys by programming data	35
Preset price	35
Preset tax status	35
Locking out high amount limitation	35
Preparing and using PLUs	36
Programming PLUs	36
To program a unit price for each PLU	36
To program tax calculation status for each PLU	36
Registering PLUs.....	37
Shifting the taxable status of an item	39
Calculation merchandise subtotal	39
Preparing and using discounts	40
Programming discounts	40
Registering discounts	40
Discount for items and subtotals	40
Preparing and using reductions	41
Programming for reductions	41
To program preset reduction amount	41
Registering reductions	41
Reduction for items.....	41
Reduction for subtotal	42

Registering credit and check payments	43
Check	43
Credit	43
Mixed tender (cash, credit and check)	43
Preparing and registering the Euro	44
Basic programming for the Euro and its exchange rate	44
Registering the Euro	44
Validation printing	46
Total amount validation	46
Validation sample	46
Registering returned goods in the REG mode	47
Registering returned goods in the RF mode	47
Normal refund transaction	47
Reduction of amounts paid on refund	48
Registering money received on account	48
Registering money paid out	48
Registering loan amounts	49
Registering pick up amounts	49
Changing media in drawer	49
Making corrections in a registration	50
To correct an item you input but not yet registered	50
To correct an item you input and registered	51
To cancel all items in a transaction	52
No sale registration	52
Printing the daily sales reset report	53
Advanced Operations	54
Stock check	54
Clerk interrupt function	54
Single item cash sales	55
Addition	56
Addition (plus)	56
Premium (%+)	57
Tray total	58
Tray total premium/discount	58
Multiple item totalling function	58
Coupon transactions	59
Coupon registration using <COUPON> (coupon key)	59
Coupon registration using <COUPON2> (coupon 2 key)	59
Registering the second unit price	60
Preset tender amount	61
Bottle link operation	62
Bottle returns	62
Bottle return key	62
Arrangement key registrations	63
Set menu	63
Currency exchange function	64
Registering foreign currency	64
Full amount tender in foreign currency	64
Partial tender in a foreign currency	65

Introduction & Contents

Food stamp function	66
Food stamp registration	66
No change due	66
Mixed food stamp/cash change	67
Food stamp registration (Illinois rule)	69
No change due	69
Mixed food stamp/cash change	71
Electronic benefits transfer	75
About mixed EBT card tenders	75
No change due	75
Tips	76
Inputting the number of customers	77
Text recall	78
Temporarily releasing compulsion	78
Printing slip	79
Printing slips	79
To perform auto batch printing 1	80
To perform auto batch printing 2	80
About the maximum number of slip lines	80
Check tracking systems	80
Check tracking system	80
Opening a check	81
Adding to a check	81
Issuing a guest receipt	82
Closing a check memory	82
New/old check key operation	83
Add check	84
Separate check	85
Clerk transfer	86
Table transfer	86
Price reductions (red price)	87
Condiment/preparation PLUs	88
VAT breakdown printing	89
Deposit registrations	89
Deposit from customer	89
Deposit from customer during sales transaction	89
Bill copy	90
Actual stock quantity inquiry	91
Unit price inquiry	91
Previous item void using <review>	92
Scanning PLU	93
Item registration	93
By scanner/code input/one touch NLU key	93
Not found PLU	93
Programming to clerk	94
Programming clerk number	94
Programming trainee status	94
Programming commission rate	94
Programming descriptors and messages	95
Programming receipt message and clerk name	95
Machine number	95
Programming department/transaction key descriptor	97
Programming flat-PLU descriptor	98

Entering characters	99
Using character keyboard	99
Entering characters by code	100
Character code list	100
Editing characters	101
Editing characters	101
Printing read/reset reports	102
To print the individual department, PLU/flat-PLU read report	102
To print the financial read report	103
To print the individual clerk read/reset report	103
To print the daily sales read/reset report	104
To print the PLU/flat-PLU read/reset report	106
To print the hourly sales read/reset report	106
To print the monthly sales read/reset report	107
To print the group read/reset report	107
To print the periodic 1/2 sales read/reset reports	108
To print other sales read/reset reports	110
Reading the cash register's program	111
To print unit price/rate program (except PLU/scanning PLU)	111
To print key descriptor, name, message program (except PLU)	112
To print the PLU/flat-PLU program	113
Troubleshooting	114
When an error occurs	114
When the register does not operate at all	116
Clearing a machine lock up	117
In case of power failure	117
User Maintenance and Options	118
To replace the ink ribbon	118
To replace journal paper	119
To replace receipt paper	120
To replenish the stamp ink	120
Options	120
Specifications	121
Index	122

Getting Started

This section outlines how to unpack the cash register and get it ready to operate. You should read this part of the manual even if you have used a cash register before. The following is the basic set up procedure, along with page references where you should look for more details.

1. Remove the cash register from its box.

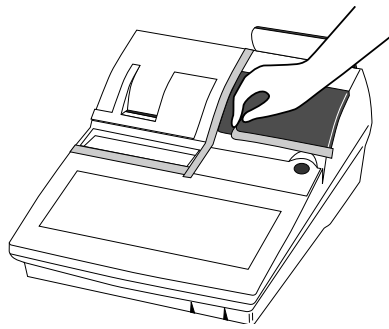
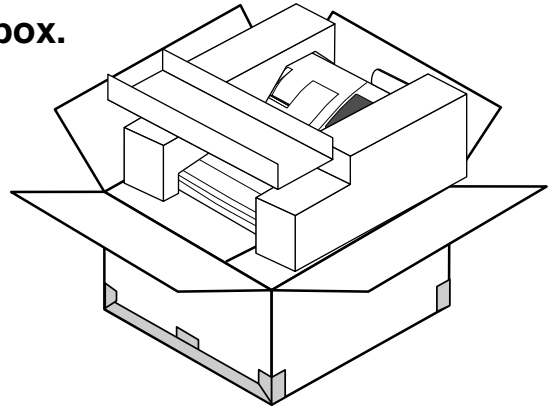

2. Remove the tape holding parts of the cash register in place.

Also remove the small plastic bag taped to the printer cover. Inside you will find the mode keys.

3. Remove the cash drawer from its box.

The cash register and cash drawer are packed separately.

4. Connect the drawer.

1. Connect drawer connector (three color lead on drawer) to the cash register.
2. Connect frame drawer connector (green lead on drawer) to the cash register.

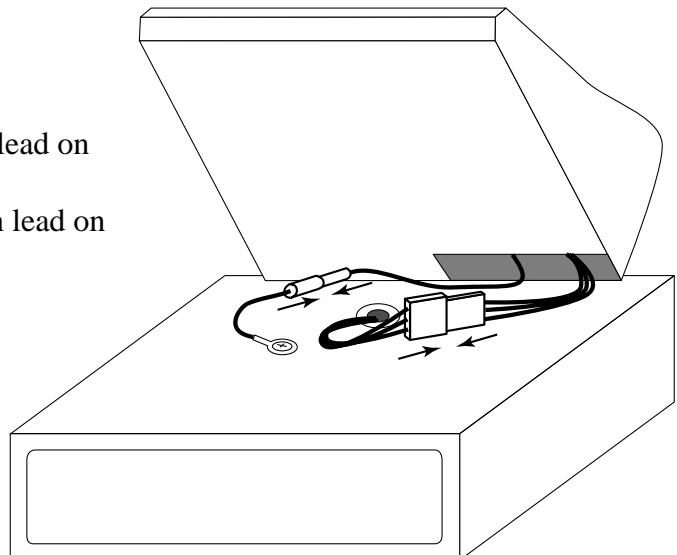

5. Mount the cash register.

1. Screw in 2 fixing screws bottom side of the register.
2. Mount the cash register on the top of the drawer, ensuring that the feet on the bottom of the cash register go into the holes on the drawer.

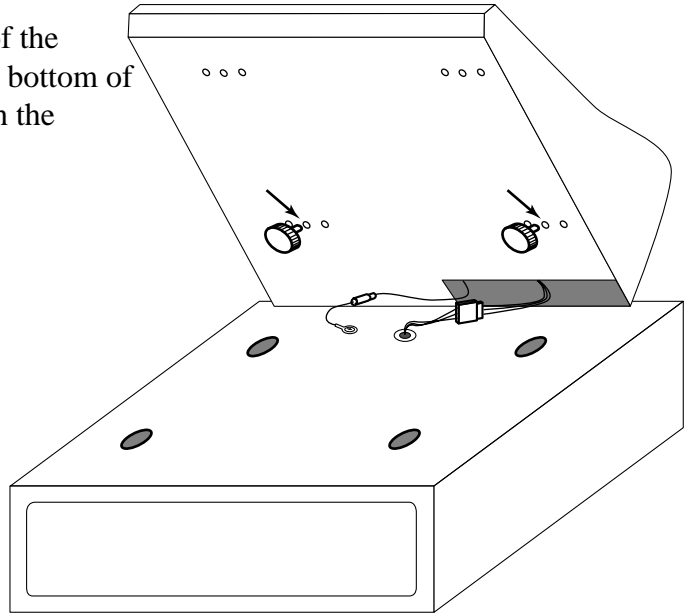

6. Plug the cash register into a wall outlet.

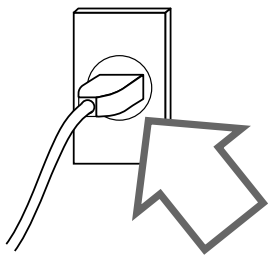

Be sure to check the sticker on the side of the cash register to make sure that its voltage matches that of the power supply in your area. The printer will operate for a few seconds. Please do not pass the power cable under the drawer.

7. Insert the mode key marked "OW" into the mode switch.

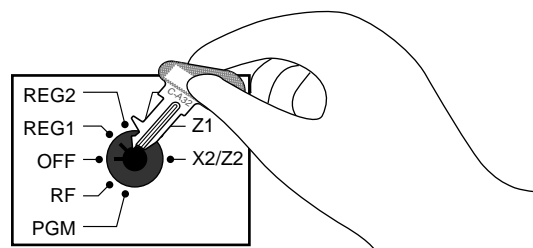

8. Install receipt/journal paper.

Loading journal paper

The same type of paper (45 mm × 83 mm i.d.) is used for receipts and journal. Load the new paper before first operating the cash register or when red paper appears from the printer.

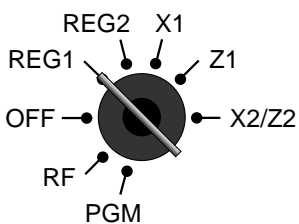

1

Use a mode key to set the mode switch to REG1 position.



5

Drop the paper roll gently and insert paper to the paper inlet.

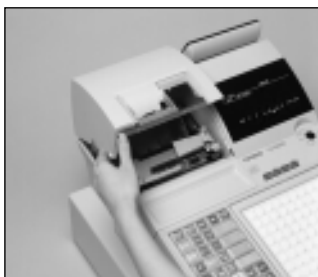

2

Open the printer cover using the printer cover key.

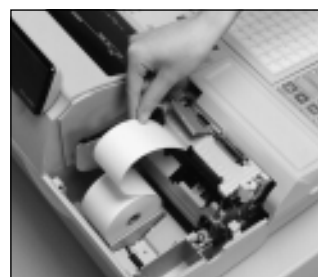

3

Cut off the leading end of the paper so it is even.

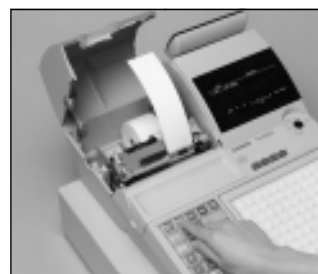

6

Press the **JOURNAL FEED** key until about 20 cm to 30 cm of paper is fed from the printer.



4

Ensuring the paper is being fed from the bottom of the roll, lower the roll into the space behind the printer.



7

Slide the leading end of the paper into the groove on the spindle of the take-up reel and wind it onto the reel two or three turns.

Loading receipt paper

Follow steps ① through ③ under “Loading journal paper” on the previous page.



⑧ Place the take-up reel into place behind the printer, above the roll paper.



⑨ Press the **JOURNAL FEED** key to take up any slack in the paper.



⑩ Close the printer cover.



④ Ensuring the paper is being fed from the bottom of the roll, lower the roll into the space behind the printer.



⑤ Drop the paper roll gently and insert paper to the paper inlet.



⑥ Press the **RECEIPT FEED** key until about 20 cm to 30 cm of paper is fed from the printer.



⑦ Set the printer cover, passing the leading end of the paper through the paper outlet. Close the printer cover and tear off the excess paper.



Important!

Never operate the cash register without paper. It can damage the printer.

9. Set the date.

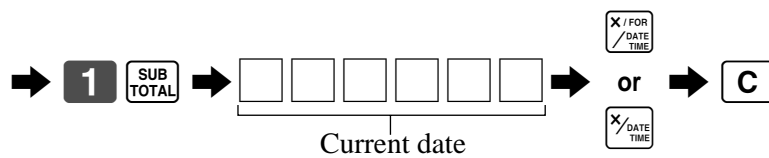
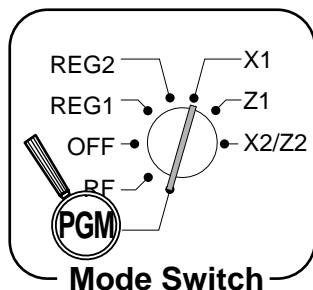

Example:

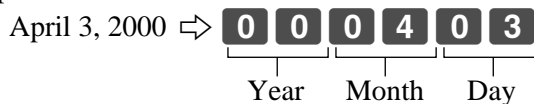

10. Set the time.

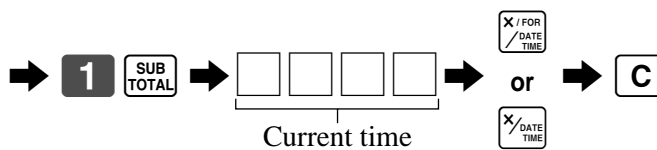
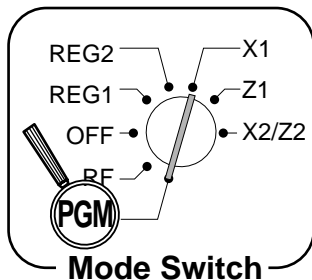

Example:

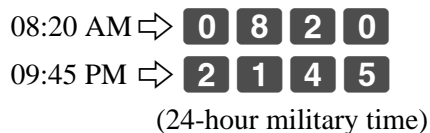

Introducing TK-7000/7500

General guide

This part of the manual introduces you to the cash register and provides a general explanation of its various parts.

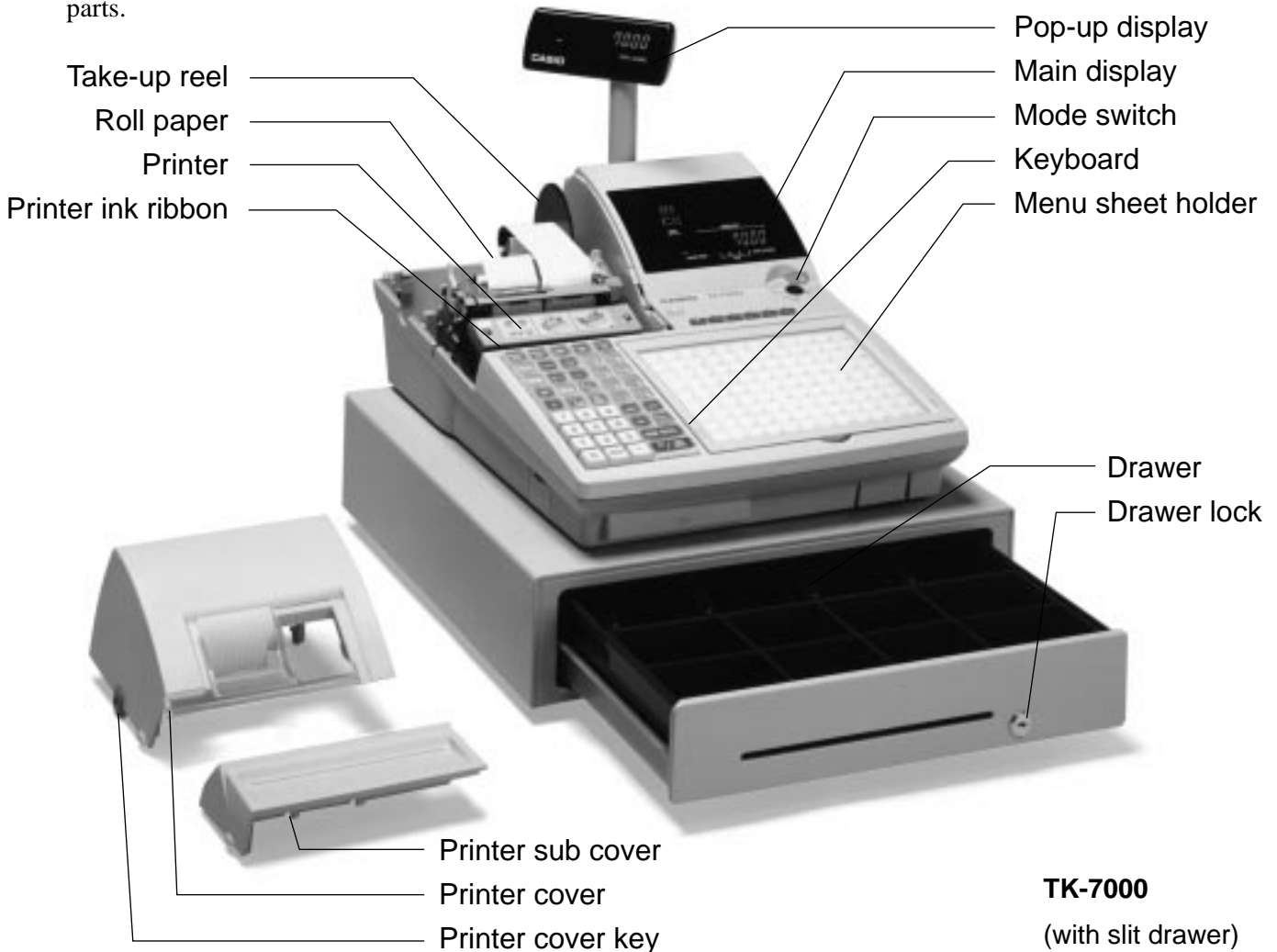

Roll paper

You can use the roll paper to print receipts and a journal (pages 10 ~ 11).

Printer ink ribbon

Provides ink for printing of registration details on the roll paper (page 118).

Receipt on/off switch / key

Use the receipt on/off switch/key in REG1, REG2 and RF modes to control issuance of receipts. In other modes, receipts or reports are printed regardless the receipt switch/key setting.

A post-finalization receipt can still be issued after finalization when the switch/key is set to off. The cash register can also be programmed to issue a post-finalization receipt even when the switch/key is set to on.

Receipt on/off switch

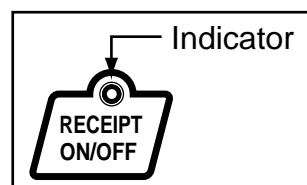

Receipt on/off key

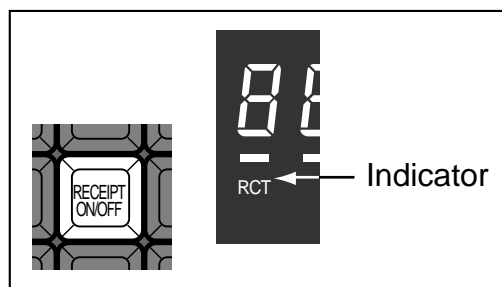

When the register issues receipts, this indicator is lit.

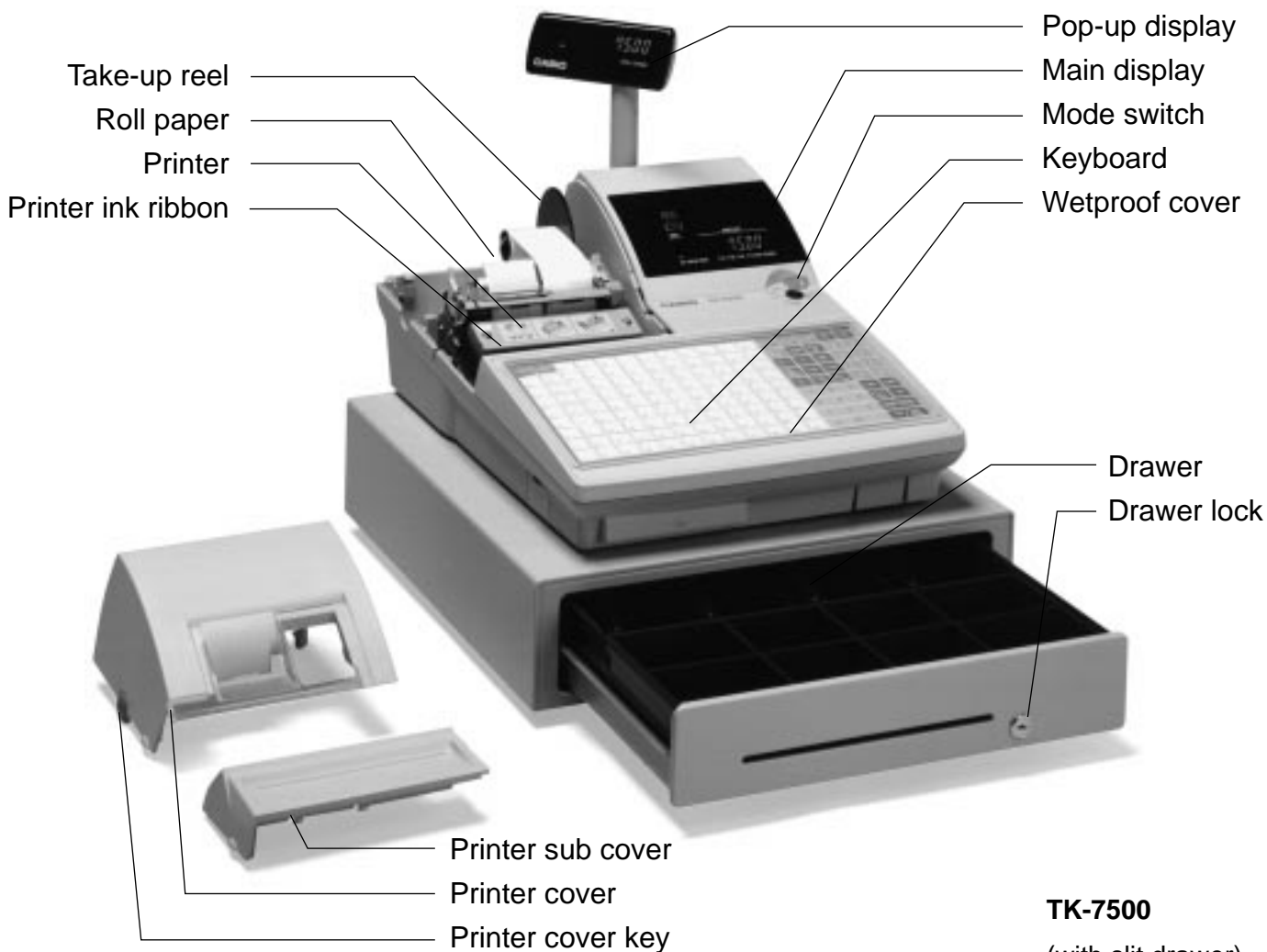

TK-7500
(with slit drawer)

Mode key (for U.K., U.S. and Canada)

The following four types of mode keys are provided with the unit in the United Kingdom, the United States and Canada.

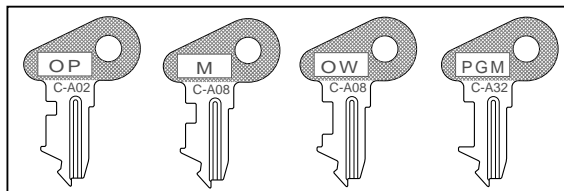

- a. OP (Operator) key
Switches between OFF and REG1.
- b. M (Master) key
Switches between OFF, REG1, REG2, X1 and RF.
- c. OW (Owner) key
Switches between OFF, REG1, REG2, X1, Z1, X2/
Z2 and RF.
- d. PGM (Program) key
Switches to any position.

Mode key (for other area)

The following three types of mode keys are provided with the unit in areas outside of the United Kingdom, the United States and Canada.

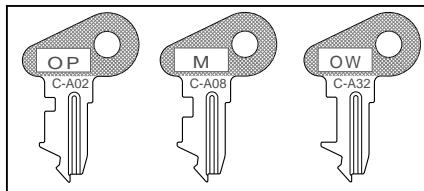

- a. OP (Operator) key
Switches between OFF and REG1.
- b. M (Master) key
Switches between OFF, REG1, REG2, X1 and RF.
- c. OW (Owner) key
Switches to any position.

Introducing TK-7000/7500

Mode switch

Use the mode keys to change the position of the mode switch and select the mode you want to use.

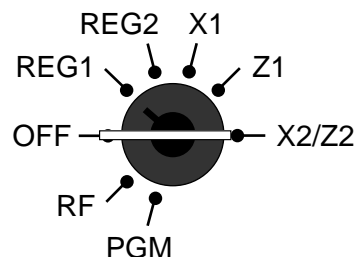

Mode switch	Mode name	Description
OFF	Stand-by	Any of the mode control keys can be inserted and removed from the mode switch in this position.
REG1	Register 1	Used for normal sales transactions. Any of the mode control keys can be inserted and removed from the mode switch in this position.
REG2	Register 2	Used for special operations. Since switching to REG2 requires a special key, such functions as discounts, credit sales, charge sales, check payments, and paid outs can be controlled by programming them as prohibited in REG1 and allowed in REG2.
RF	Refund Reg minus	Used for processing refunds. When the mode switch of the register is in RF position, you can access either the refund mode or the register minus mode.
X1	Daily sales read	Used to obtain daily reports without resetting (clearing) all total data.
Z1	Daily sales reset	Used to obtain daily reports while resetting (clearing) all total data.
X2/Z2	Periodic sale read/reset	Used to obtain periodic sales reports without resetting total data or while resetting all total data.
PGM	Program	Used when programming functions and preset data such as unit prices and tax rates. Also used when reading program data.

Clerk key/button/lock

On models available in the United States and Canada, clerk or cashier assignment can be performed using clerk secret numbers only (clerk buttons are not equipped).

In Germany, you can assign clerks by using clerk key or by clerk secret number (clerk key is equipped).

In other areas, you can assign clerks by using clerk button or by clerk secret number.

The method you are assigning clerk depends on the programming of your cash register.

Clerk secret number key

When the cash register is programmed to use clerk secret numbers for clerk or cashier assignment, the clerk buttons are not functional.

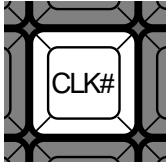

Clerk button

You can assign the clerk or cashier using the six buttons located below the display panel.



Clerk lock/key

You can assign the clerk or cashier inserting a clerk key into the clerk lock .

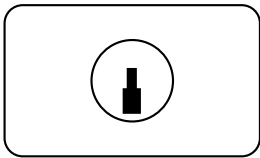

Clerk lock

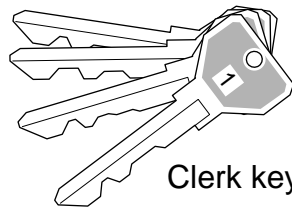

Clerk key

Drawer

The drawer opens automatically whenever you finalize a registration and whenever you issue a read or reset report.

Drawer lock (for medium size drawer)

Use the drawer key to lock and unlock the drawer.

Drawer open key (for large size drawer)

Use the drawer open key to open the drawer.

When the cash drawer does not open! (for medium size drawer only)

In case of power failure or the machine is in malfunction, the cash drawer does not open automatically. Even in these cases, you can open the cash drawer by pulling drawer release lever (see below).

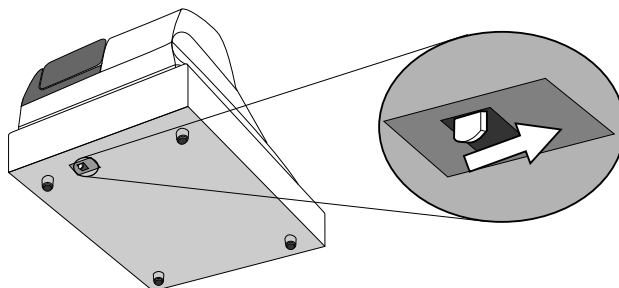

Important!

The drawer will not open, if it is locked with a drawer lock key.

Introducing TK-7000/7500

Display

Display panel

Main display for the U.S.



Customer display for all area



Main display for Canada and Germany



Main display for other area



Display example

Item registration



① **Amount/Quantity**
This part of the display shows monetary amounts. It also can be used to show the current time.

② **Item descriptor**
When you register a department/PLU/scanning PLU, the item descriptor appears here.

③ **Item counter**
Number of item sold is displayed.

④ **Subtotal amount**
Current subtotal amount (add-on tax excluded) is displayed.

Repeat registration



⑤ **Number of repeats**
Anytime you perform a repeat registration (pages 32, 37), the number of repeats appears here. Note that only one digit is displayed for the number of repeats. This means that a “5” could mean 5, 15 or even 25 repeats.

⑥ **2nd, 3rd menu indicator**
When you press **PRICE SHIFT** to designate the 2nd/3rd unit price, the corresponding number is displayed.

⑦ **Taxable sales status indicators**
When you register a taxable item, the corresponding indicator is lit.

⑧ **Amount tendered key descriptor/amount**

⑨ **Change descriptor/amount**

⑩ **Total/Change indicators**
When the TOTAL indicator is lit, the displayed value is monetary total or subtotal amount. When the CHANGE indicator is lit, the displayed value is the change due.

Totalize operation

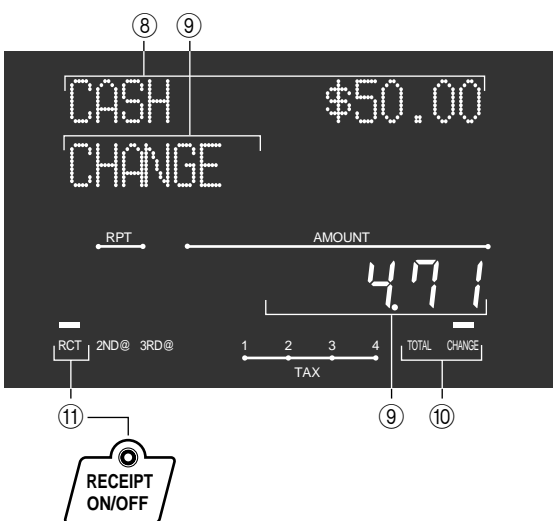

⑪ **RCT indicator**
When the register issues receipts, this indicator is lit.

Introducing TK-7000/7500

Keyboard (TK-7000)

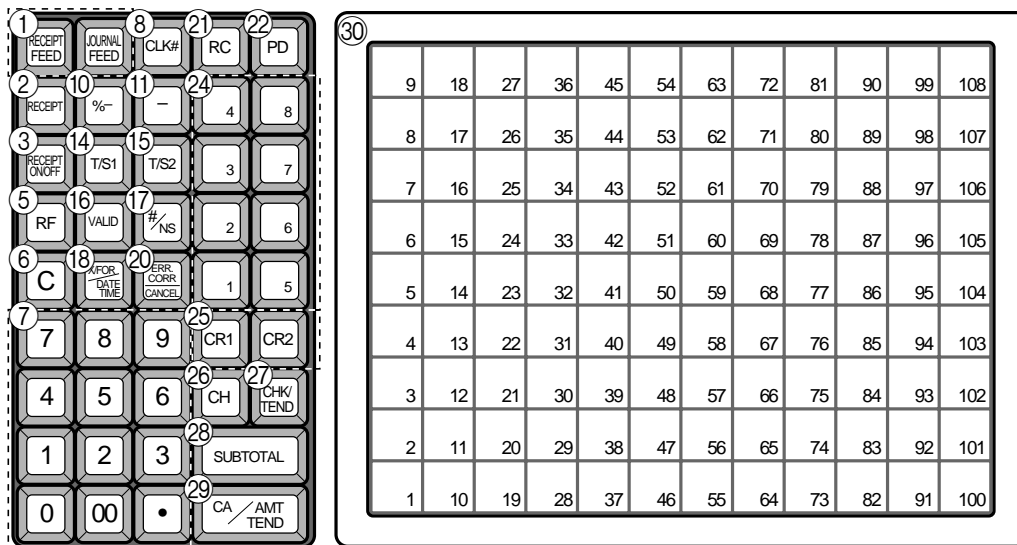

for U.S.

• Register Mode

- ① **Paper feed key** ,
Hold this key down to feed paper from the printer.
- ② **Post receipt key**
Use this key to produce a post-finalization receipt.
- ③ **Receipt on/off key**
Use this key twice to change the status “receipt issue” or “no receipt.” In case of “receipt issue”, the indicator is lit.
- ④ **Open key**
Use this key to temporarily release a limitation on the number of digits that can be input for a unit price.
- ⑤ **Refund key**
Use this key to input refund amounts and void certain entries.
- ⑥ **Clear key**
Use this key to clear an entry that has not yet been registered.
- ⑦ **Ten key pad** , ~ , ,
Use these keys to input numbers.
- ⑧ **Clerk number key**
Use this key to sign clerk on and off the register.
- ⑨ **VAT key**
Use this key to print a VAT breakdown.
- ⑩ **Discount key**
Use this key to register discounts.
- ⑪ **Minus key**
Use this key to input values for subtraction.
- ⑫ **Loan key**
This key is used to input the amount of money provided for making change. This operation affects media totals, rather than sales totals. Loans are made for all types of money which can be specified by the finalize key.
- ⑬ **Pick up key**
When the amount in drawer exceeds the limit value (sentinel function), the manager performs a pick up operation. This key is used for this function. This operation affects media totals, rather than sales totals. Pick ups are made for all types of money which can be specified by the finalize key.
- ⑭ **Tax status shift 1 key**
Use this key to change the Taxable 1 status of the next item.
- ⑮ **Tax status shift 2 key**
Use this key to change the Taxable 2 status of the next item.
- ⑯ **Validation key**
Use this key to validate transaction amounts on slip.
- ⑰ **Non-add/No sale key**
Non-add key: To print reference number (to identify a personal check, credit card, etc.) during a transaction, use this key after some numerical entries.
No sale key: Use this key to open the drawer without registering anything.

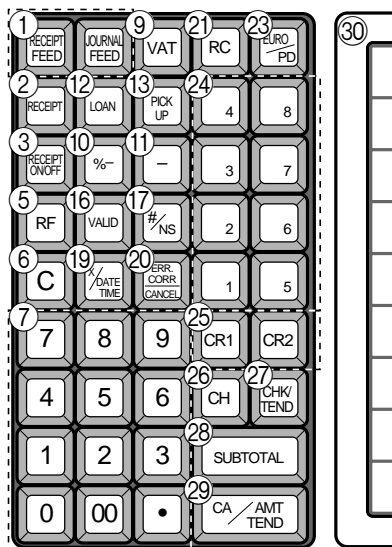

for German

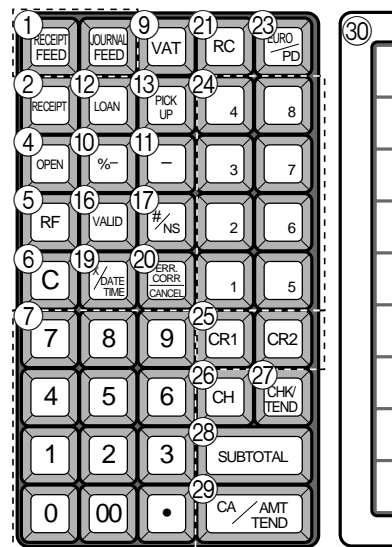

for other area

- 18 **Multiplication/For/Date/Time key** X / FOR
DATE
TIME
Use this key to input a quantity for a multiplication operation and registration of split sales of packaged items. Between transactions, this key displays the current time and date.
- 19 **Multiplication/Date/Time key** X / DATE
TIME
Use this key to input a quantity for a multiplication operation. Between transactions, this key displays the current time and date.
- 20 **Error correction/Cancellation key** ERR CORR
CANCEL
Use this key to correct registration errors and to cancel registration of entire transactions.
- 21 **Received on account key** RC
Use this key following a numeric entry to register money received for non-sale transactions.
- 22 **Paid out key** PD
Use this key following a numeric entry to register money paid out from the drawer.
- 23 **Euro/Paid out key** EURO
PD
Euro key: Use this key to convert the main currency to the sub currency (the euro/the local money), when registering a subtotal amount. This key is also used for specifying sub currency while entering an amount of payment or declaration in drawers.
Paid out key: Use this key following a numeric entry to register money paid out from the drawer.
- 24 **Department keys** 1, 2, 3 ~ 8
Use these keys to register items to departments.
- 25 **Credit key** CR1, CR2
Use this key to register a credit sale.
- 26 **Charge key** CH
Use this key to register a charge sale.
- 27 **Check key** CHK/
TEND
Use this key to register a check tender.
- 28 **Subtotal key** SUB
TOTAL
Use this key to display and print the current subtotal (includes add-on tax) amount.
- 29 **Cash/Amount tendered key** CA / AMT
TEND
Use this key to register a cash tender.
- 30 **Flat PLU key** 001, 002 ~ 108
Use these keys to register items to flat PLUs.





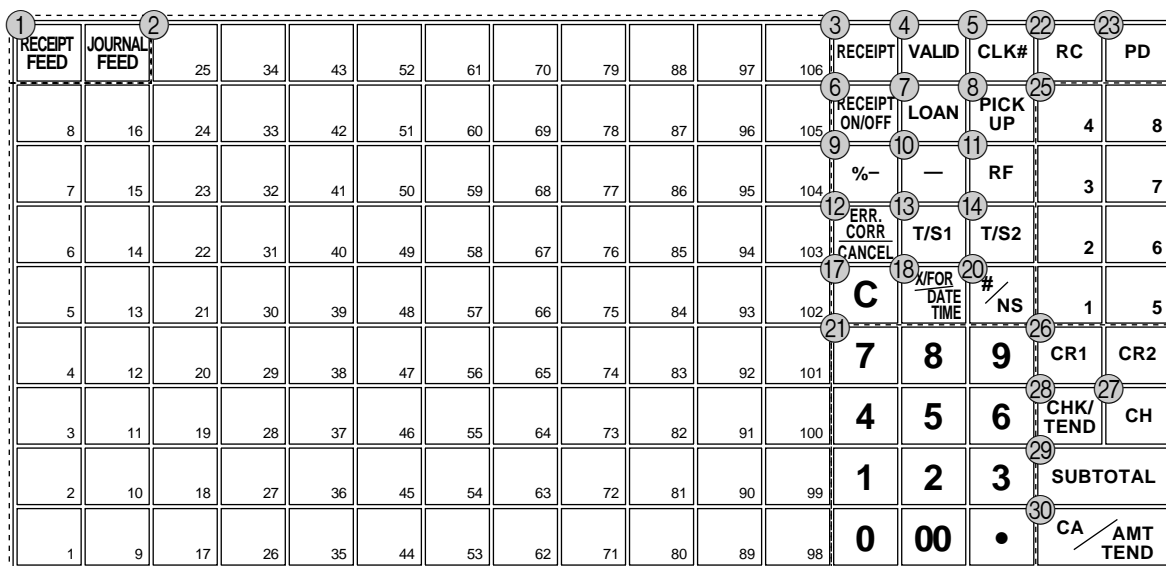















Introducing TK-7000/7500

Keyboard (TK-7500)













for the U.S./Canada

• Register Mode

- ① **Paper feed key**  , 
Hold this key down to feed paper from the printer.
- ② **Flat PLU key**  ,  ~ 
Use these keys to register items to flat PLUs.
- ③ **Post receipt key** 
Press this key to produce a post-finalization receipt.
- ④ **Validation key** 
Use this key to validate transaction amounts on slip.
- ⑤ **Clerk number key** 
Use this key to sign clerk on and off the register.
- ⑥ **Receipt on/off key** 
Use this key twice to change the status “receipt issue” or “no receipt.” In case of “receipt issue”, the indicator is lit.
- ⑦ **Loan key** 
This key is used to input the amount of money provided for making change. This operation affects media totals, rather than sales totals. Loans are made for all types of money which can be specified by the finalize key.
- ⑧ **Pick up key** 
When the amount in drawer exceeds the limit value (sentinel function), the manager performs a pick up operation. This key is used for this function. This operation affects media totals, rather than sales totals. Pick ups are made for all types of money which can be specified by the finalize key.
- ⑨ **Discount key** 
Use this key to register discounts.
- ⑩ **Minus key** 
Use this key to input values for subtraction.
- ⑪ **Refund key** 
Use this key to input refund amounts and void certain entries.
- ⑫ **Error correction/Cancellation key** 
Use this key to correct registration errors and to cancel registration of entire transactions.
- ⑬ **Tax status shift 1 key** 
Use this key to change the Taxable 1 status of the next item.
- ⑭ **Tax status shift 2 key** 
Use this key to change the Taxable 2 status of the next item.
- ⑮ **Open key** 
Use this key to temporarily release a limitation on the number of digits that can be input for a unit price.
- ⑯ **VAT key** 
Use this key to print a VAT breakdown.
- ⑰ **Clear key** 
Use this key to clear an entry that has not yet been registered.
- ⑱ **Multiplication/For/Date/Time key** 
Use this key to input a quantity for a multiplication operation and registration of split sales of packaged items. Between transactions, this key displays the current time and date.

1	RECEIPT FEED	2	JOURNAL FEED	25	34	43	52	61	70	79	88	97	106	3	RECEIPT	4	VALID	5	CLK#	22	RC	24	EURO PD
8	16	24	33	42	51	60	69	78	87	96	105	104	103	6	RECEIPT ON/OFF	7	LOAN	8	PICK UP	25	4	8	
7	15	23	32	41	50	59	68	77	86	95	104	103	102	9	%-	10	-	11	RF	3	7		
6	14	22	31	40	49	58	67	76	85	94	103	102	101	12	ERR. CORR CANCEL	15	OPEN	16	VAT	2	6		
5	13	21	30	39	48	57	66	75	84	93	102	101	100	17	C	19	X DATE TIME	20	# NS	1	5		
4	12	20	29	38	47	56	65	74	83	92	101	100	99	21	7	8	9	26	CR1	CR2			
3	11	19	28	37	46	55	64	73	82	91	100	99	98	4	5	6	27	28	CH	CHK/TEND			
2	10	18	27	36	45	54	63	72	81	90	99	98	97	1	2	3	29	30	SUBTOTAL				
1	9	17	26	35	44	53	62	71	80	89	98	97	96	0	00	•	30	CA	AMT TEND				

for U.K.

- ①⑨ **Multiplication/Date/Time key**  Use this key to input a quantity for a multiplication operation. Between transactions, this key displays the current time and date.
- ①⑩ **Non-add/No sale key**  Non-add key: To print reference number (to identify a personal check, credit card, etc.) during a transaction, use this key after some numerical entries.
No sale key: Use this key to open the drawer without registering anything.
- ①⑪ **Ten key pad** **0**, **1** ~ **9**, **00**, **•** Use these keys to input numbers.
- ①⑫ **Received on account key**  Use this key following a numeric entry to register money received for non-sale transactions.
- ①⑬ **Paid out key**  Use this key following a numeric entry to register money paid out from the drawer.
- ①⑭ **Euro/Paid out key**  Euro key: Use this key to convert the main currency to the sub currency (the euro/the local money), when registering a subtotal amount. This key is also used for specifying sub currency while entering an amount of payment or declaration in drawers.
Paid out key: Use this key following a numeric entry to register money paid out from the drawer.
- ①⑮ **Department keys** **1**, **2**, **3** ~ **8** Use these keys to register items to departments.
- ①⑯ **Credit key**  Use this key to register a credit sale.
- ①⑰ **Charge key**  Use this key to register a charge sale.
- ①⑱ **Check key**  Use this key to register a check tender.
- ①⑲ **Subtotal key**  Use this key to display and print the current subtotal (includes add-on tax) amount.
- ①⑳ **Cash/Amount tendered key**  Use this key to register a cash tender.

Allocatable functions

You can tailor a keyboard to suit your particular type of business.

Add check

Use this key in a check tracking system to combine the details of more than one check into a single check.

Arrangement

Use this key to activate an arrangement program programmed in the arrangement file. Any operation that can be performed from the keyboard, as well as mode, can be programmed in an arrangement program, and can be performed merely by pressing this key. In addition, one numeric entry can be included in an arrangement program. In this case, input the number and press this key.

The mode control function of this key can be programmed for all modes except for the OFF and PGM mode.

Bill copy

Use this key to issue bill copy.

Bottle return

Use this key to specify next item as bottle return.

Cancel

Invalidates all preceding data registered for departments, PLUs and set menus within a transaction. This key must be pressed before the transaction involving the data to be invalidated is finalized. It is also effective even after calculation of subtotal amount.

Check endorsement

Use this key to print a preset check endorsement message using the slip printer.

Check print

Use this key to print the check on the slip printer.

Clerk transfer

Use this key to transfer opened checks to another clerk.

Coupon

Use this key for registering coupons.

Coupon 2

Use this key to declare the next item registration as coupon.

Cube

This key provides the same functions as the Square key. In addition, this key also has a cube multiplication function.

Currency exchange

Use this key to convert foreign currency to local currency or vice versa using the exchange rate preset for the key and displays the result.

Use this key for conversions of a home currency subtotal or merchandise subtotal to equivalent of another country's currency.

Use this key for conversions of another country's currency to the equivalent of the home currency.

Customer number

Use this key to register the number of customers.

Declaration

Use this key to declare in drawer amount for money declaration.

Deposit

Use this key to register deposits.

Eat-in

Use this key to specify if the customer eats in the restaurant. Before closing a transaction press this key.

EBT (electronic benefit transfer)

Use this key to register an EBT amount with a tender amount input.

Food stamp shift

Use this key to change food stamp status.

Food stamp subtotal

Use this key to obtain the food stamp applicable amount.

Food stamp tender

Use this key to register a food stamp payment amount with a tender amount input.

Ketten Bon

Use this key to enter quantities for multiplication. Multiplication by this key issues singular order prints.

Manual tax

Use this key to register a tax amount.

Menu shift

Use this key to shift key to the 1st ~ 6th menu.

Merchandise subtotal

Use this key to obtain subtotal excluding the add-on tax amount and the previous balance.

New balance

Use this key for adding the latest registered total amount to the previous balance to obtain a new balance.

New check

Use this key in a check tracking system to input a new check number in order to open a new check under that number.

New/Old check

Use this key in a check tracking system to input check numbers in order to open new checks and to reopen existing checks. When the clerk inputs a check number, the register checks to see if that number already exists in the check tracking memory. If there is no matching number in the memory, a new check is opened under the input number. If the check number input matches a number already stored in the memory, that check is reopened for further registration or finalization.

No sale

Use this key to open the drawer between transaction.

Non add

Use this key to print reference numbers (personal check number, card number, etc.)

Normal receipt

Use this key to change the order status from Bon to normal.

OBR (Optical barcode reader)

Use this key to input optical barcodes manually.

Old check

Use this key in a check tracking system to input the number of an existing check (previously created by the New check key) whose details are stored in the check tracking memory. Existing checks are reopened to perform further registration or to finalize them.

One touch NLU

Use this key to register scanning PLU directly from the keyboard. There is one One touch NLU key for one scanning PLU, and multiple one touch NLU keys can be set on the keyboard.

Open 2

Use this key to suspend the compulsory specifications.

Open check

Use this key to issue an open check report of an assigned clerk.

Operator number

Use this key to enter a clerk number during clerk transfer.

Operator X/Z

Use this key to issue a clerk's individual X/Z report.

Plus

Use this key for registering surcharge.

Premium

Use this key to apply a preset % or manual input % to obtain the premium amount for the last registered item or subtotal.

Previous balance

Use this key to register the previous negative/positive balance at the beginning of or during a transaction.

Previous balance subtotal

Use this key to obtain subtotal excluding the add-on tax amount and current balance.

Price

Use this key to register an open PLU.

Price change

Use this key to change scanning PLU unit price temporarily.

Price inquiry

Use this key to confirm the price and descriptors of PLU without registering.

Price shift

Use this key to shift a PLU item/flat-PLU key to the 1st ~ 2nd unit price, a scanning PLU to the 1st ~ 3rd unit price.

Rate tax

Use this key to activate the preset tax rate or manually input rate to obtain the tax for the preceding taxable status 1 amount.

Recall

Use this key for recalling the transferred check number by the store key. When this key is pressed, the check number will appear in order of the oldest record.

Red price

Use this key to register a new (discounted) price of an item.

Review

Use this key to examine the current transaction by displaying item descriptor and registered amount. This key is also used for void operation or separate check operation.

Scale

Use this key to read the weight of the item and shows it on the display. This key is also used to input the weight manually.

Separate check

Use this key in a check tracking system to separate selected items from one check to another check.

Slip feed/release

Use this key to feed slips inserted into the slip printer. This is done by specifying the number of feed lines. This key is also used to release the slip paper holder if numbers are not entered.

Slip back feed/release

Use this key to back feed slips inserted into the slip printer. This is done by specifying the number of feed lines. This key is also used to release the slip paper holder if numbers are not entered.

Slip print

Use this key to execute a slip batch printing on the slip printer. Pressing this key prints the sales details. Actual printing is performed following receipt issuance.

Square

This key provides the same functions as the Multiplication key. In addition, this key also has a square multiplication function.

Stock inquiry

Use this key to check the current stock quantity for a PLU without registering.

Store

Use this key for storing the check number of the registered items. When this key is pressed, registered item data will be stored, and then these data will transfer to the youngest check number.

Table number

Use this key to input table numbers.

Table transfer

Use this key to transfer the contents of a check to another check.

Takeout

Use this key to specify if the customer takes out items. Before total a transaction. Press this key for the tax exemption.

Tare

Use this key to input tare weight.

Tax exempt

Use this key to change taxable amounts to nontaxable amounts.

Taxable amount subtotal

Use this key to obtain taxable amount subtotal.

Text print

Use this key to enter characters to print.

Text recall

Use this key to print preset characters.

Tip

Use this key to register tips.

Tray total

Use this key to display the total amount for all registrations from the last registration until this key is pressed or registrations between presses of this key.

Unit weight

Use this key to input the unit weight of a scalable item.

Void

Use this key to invalidate preceding item data registered.

Introducing TK-7000/7500

How to remove/replace the sheet holder (TK-7000 only)

Remove the sheet holder

Follow steps 1 ~ 2.

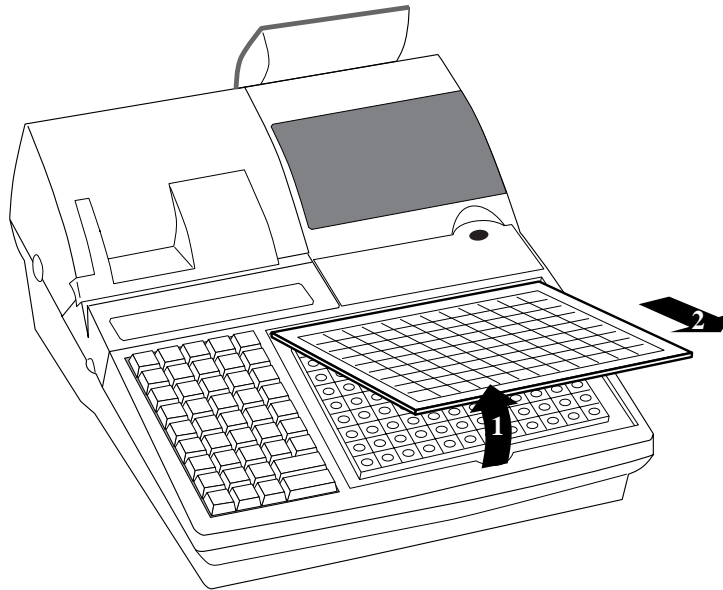

Replace the sheet holder

Follow steps 3 ~ 4.

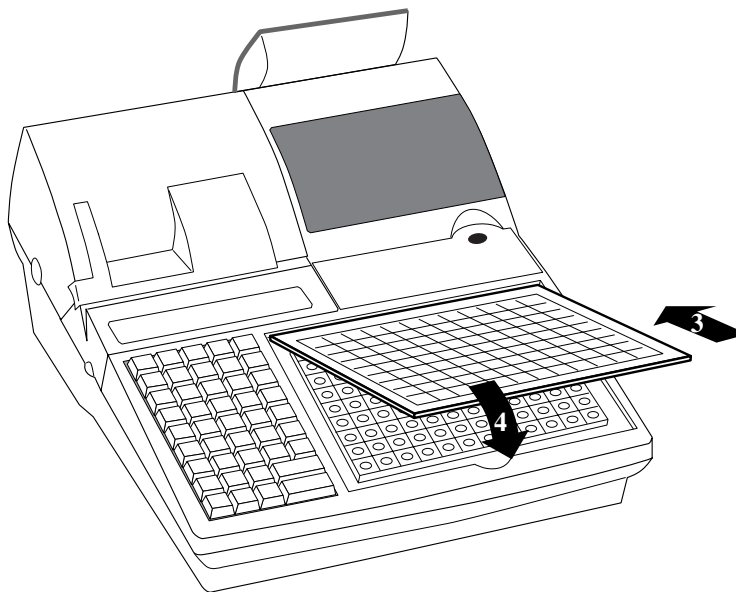

How to install a menu sheet in the sheet holder (TK-7000 only)

Open the sheet holder

Follow the steps 1 ~ 3.

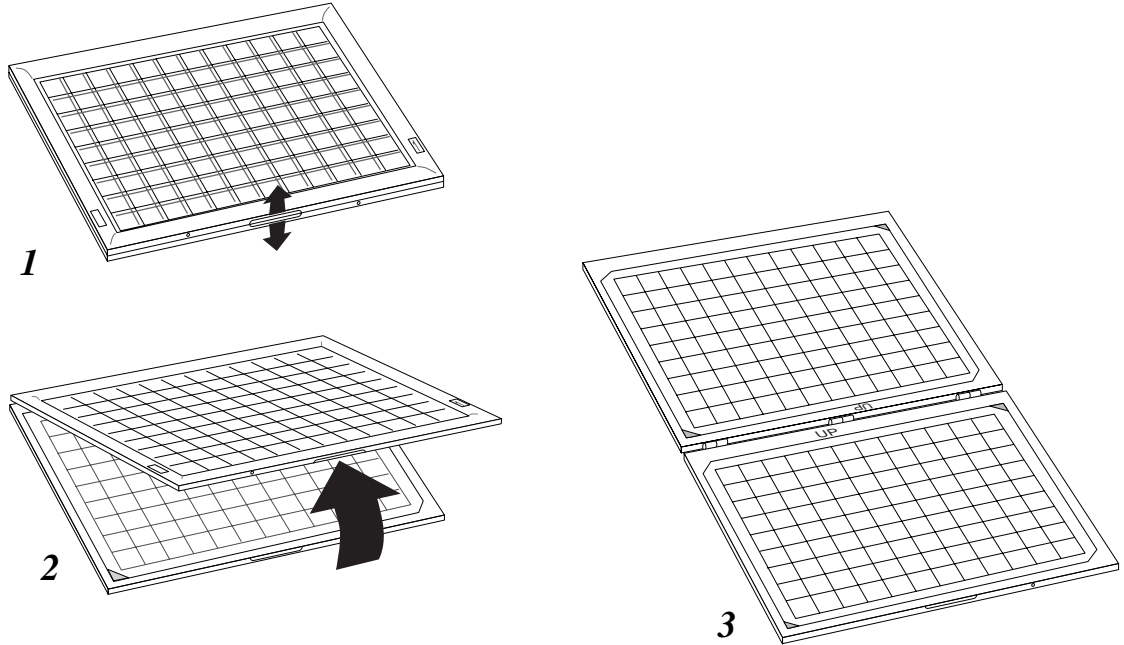

Set a menu sheet in the sheet holder

Follow the steps 4 ~ 6.

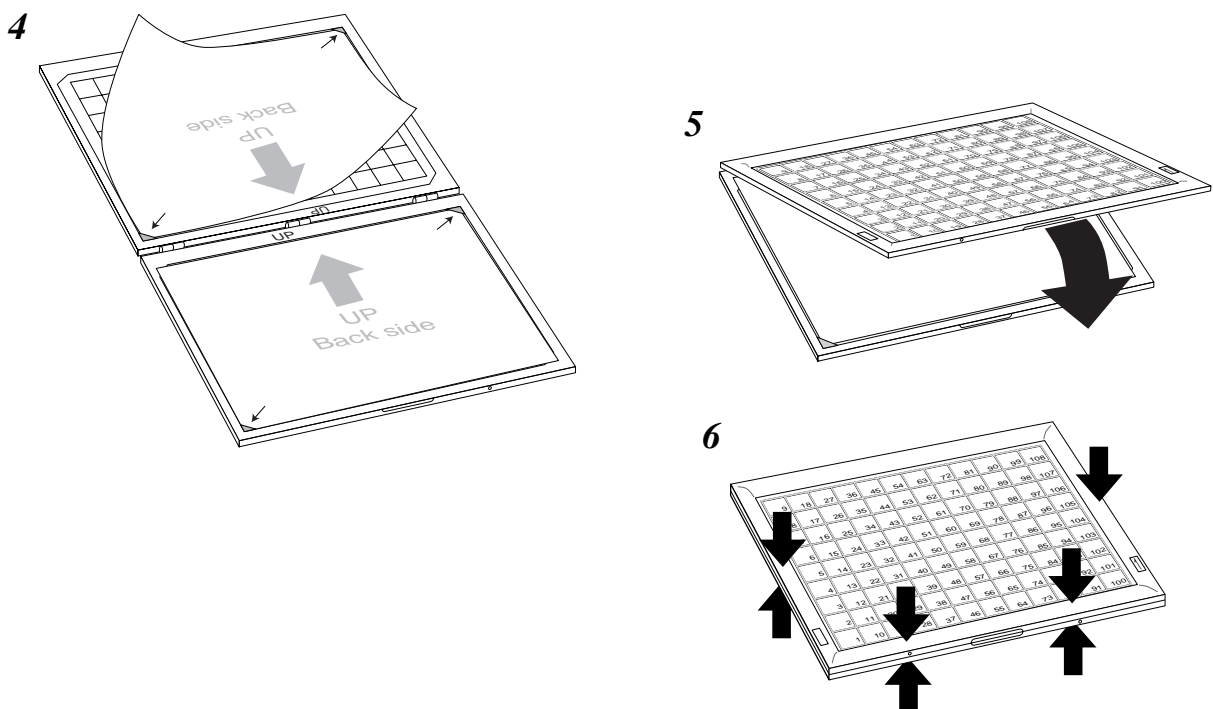

How to read the printouts

- The journal and receipts are records of all transactions and operations.
- The contents printed on receipts and journal are almost identical.
- You can choose the journal skip function.

If the journal skip function is selected, the cash register will print the total amount of each transaction, and the details of premium, discount and reduction operations only, without printing department and PLU item registrations on the journal.

- The following items can be skipped on receipts and journal.
 - Consecutive number
 - Taxable status
 - Taxable amount
 - Item counter

Receipt Sample

```

*****
* THANK YOU *
** CALL AGAIN **
*****

* COMMERCIAL MESSAGE *
* COMMERCIAL MESSAGE *
* COMMERCIAL MESSAGE *
* COMMERCIAL MESSAGE *

REG 03-04-2000 11:58
C01 MC#01 000123

1 DEPT01 T1 -1.00
1 DEPT02 T1 -2.00
5 DEPT03 -5.00

7 No
TA1 -3.00
TX1 -0.15
TL -8.15
CASH -10.00
CG -1.85

*** BOTTOM MESSAGE ***
*** BOTTOM MESSAGE ***
*** BOTTOM MESSAGE ***
*** BOTTOM MESSAGE ***
    
```

Logo message

Commercial message

Mode/Date/Time
Clerk/Machine No.
Consecutive No.

Q'ty/Item

Item counter

Bottom message

Journal Sample (Item lines Included)

```

REG 03-04-2000 11:58
C01 MC#01 000123
1 DEPT01 T1 -1.00
1 DEPT02 T1 -2.00
5 DEPT03 -5.00

7 No
TA1 -3.00
TX1 -0.15
TL -8.15
CASH -10.00
CG -1.85

REG 03-04-2000 11:59
C02 MC#01 000124
1 DEPT01 T1 -1.00
1 DEPT03 T1 -3.00
1 DEPT02 T1 -2.00
1 DEPT04 T1 -4.00
5 DEPT05 -5.00

9 No
TA1 -10.00
TX1 -0.50
TL -15.50
CASH -20.00
CG -4.50
    
```

Journal Sample (Item lines Skipped)

```

REG 03-04-2000 11:57
C01 MC#01 000123
7 No
TA1 -3.00
TX1 -0.15
TL -8.15
CASH -10.00
CG -1.85

REG 03-04-2000 11:57
C02 MC#01 000124
9 No
TA1 -10.00
TX1 -0.50
TL -15.50
CASH -20.00
CG -4.50

REG 03-04-2000 11:58
C01 MC#01 000125
7 No
TA1 -3.00
TX1 -0.15
TL -9.35
CASH -10.00
CG -0.65

REG 03-04-2000 11:59
    
```

In the operation examples contained in this manual, the print samples are what would be produced if the roll paper is being used for receipts. They are not actual size. Actual receipts are 45 mm wide. Also, all sample receipts and journals are printout images.

How to use your cash register

The following describes the general procedure you should use in order to get the most out of your cash register.

BEFORE business hours...

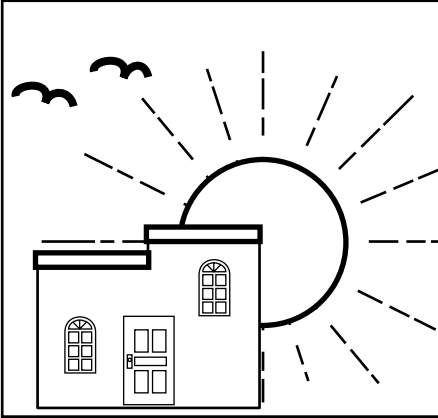

- Check to make sure that the cash register is plugged in securely. Page 9
- Check to make sure there is enough paper left on the roll. Pages 10, 11
- Read the financial totals to confirm that they are all zero. Page 103
- Check the date and time. Page 31

DURING business hours...

- Register transactions. Page 32
- Periodically read totals. Page 102

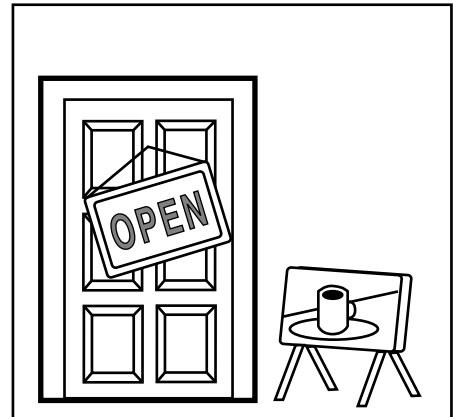

AFTER business hours...

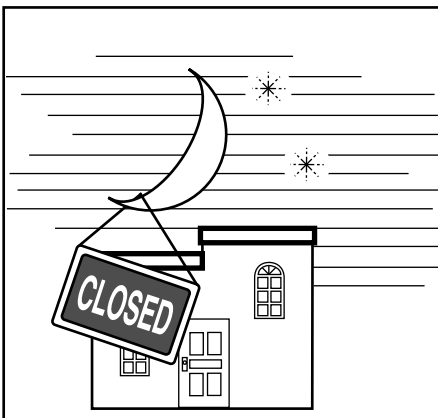

- Reset the daily totals. Page 53
- Remove the journal. Page 119
- Empty the cash drawer and leave it open. Page 17
- Take the cash and journal to the office.

Basic Operations and Setups

Assigning a clerk



On models available in the United States and Canada, clerk or cashier assignment can be performed using clerk secret numbers only (clerk buttons are not equipped). In Germany, you can assign clerks by using clerk key or by clerk secret number (clerk key is equipped). In other areas, you can assign clerks by using clerk button or by clerk secret number. The method you use for assigning a clerk depends on the programming of your cash register.

Clerk button

You can assign the clerk or cashier using the six buttons located below the display panel.

Clerk lock/clerk key

You can assign the clerk or cashier by inserting a clerk key into the clerk lock.

Clerk secret number key

When the cash register is programmed to use clerk secret numbers for clerk or cashier assignment, the clerk buttons are not functional.

Clerk sign on

	OPERATION	RECEIPT
Signing clerk 1 on:	1 → <input type="button" value="CLK#"/>	
Signing clerk 2 on:	2 → <input type="button" value="CLK#"/>	
...	...	
Signing clerk 15 on:	1 5 → <input type="button" value="CLK#"/> Clerk secret number (1 ~ 15 is set as default.)	

- If you do not want the clerk secret number to be shown on the display, press before entering the number.

Clerk sign off

	OPERATION
Signing clerk off: (except PGM mode)	0 → <input type="button" value="CLK#"/>

- The current clerk is also signed off whenever you set the mode switch to OFF position.

Important!

- The error code "E008" appears on the display whenever you try to perform a registration, a read/reset operation without signing on.
- A clerk cannot sign on unless other clerk is signed off.
- The signed on clerk is also identified on the receipt/journal.

Displaying the time and date

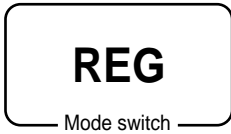

You can show the time or date on the display of the cash register whenever there is no registration being made.

To display and clear the date/time

OPERATION

DISPLAY

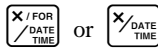

Date/time appears on the display.

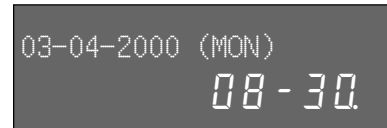

Clears the date/time display.



Preparing coins for change



You can use the following procedure to open the drawer without registering an item. This operation must be performed out of a sale.
(You can use the **RC** key instead of the **#/NS** key. See page 52.)

Opening the drawer without a sale

OPERATION

RECEIPT

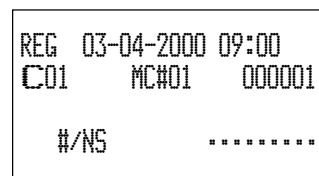

Preparing and using department/flat-PLU keys

Registering department/flat-PLU keys



The following examples show how you can use the department/flat-PLU keys in various types of registrations.

Single item sale

Example 1

OPERATION

RECEIPT

Item	Unit price	\$1.00
	Quantity	1
	Dept.	1
Payment	Cash	\$1.00

1 00
Unit price

1
Department

Department

CA/AMT
TEND

REG	03-04-2000	09:05	Date/time
C01	MC#01	000002	Mode/consecutive No.
1	DEPT01	-1.00	Department No./unit price
	TL	- 1.00	Total amount
	CASH	-1.00	

Example 2 (Subtotal registration and change computation)

OPERATION

RECEIPT

Item	Unit price	\$12.34
	Quantity	1
	Flat-PLU	1
Payment	Cash	\$20.00

1 2 3 4
Unit price

001
Flat-PLU

Flat-PLU

**SUB
TOTAL**

2 0 00 CA/AMT
TEND

Amount tendered

REG	03-04-2000	09:10	Date/time
C01	MC#01	000003	Mode/consecutive No.
1	PLU001	-12.34	Total amount
	TL	- 12.34	Amount tendered
	CASH	-20.00	Change
	CG	-7.66	

Repeat

OPERATION

RECEIPT

Item	Unit price	\$1.50
	Quantity	3
	Dept.	1
Payment	Cash	\$10.00

1 5 0 **1**
Unit price

1
Department

1
Department

**SUB
TOTAL**

1 0 00 CA/AMT
TEND

REG	03-04-2000	09:15	Date/time
C01	MC#01	000004	Mode/consecutive No.
1	DEPT01	-1.50	Repeat
1	DEPT01	-1.50	Repeat
1	DEPT01	-1.50	Repeat
	TL	- 4.50	Total amount
	CASH	-10.00	Amount tendered
	CG	-5.50	Change

Multiplication

OPERATION

RECEIPT

Item	Unit price	\$1.00
	Quantity	12
	Flat-PLU	1
Payment	Cash	\$20.00

DATE TIME
1 **2** DATE TIME
 Quantity
 (4-digit integer/2-digit decimal)
1 **00** DATE TIME
2 **0** **00** DATE TIME
 SUB TOTAL
 CA/AMT TEND

REG	03-04-2000	09:20
C01	MC#01	000005
12	PLU0001	-12.00
12	@1/ 1.00	-12.00
PLU0001		
TL		-12.00
CASH		-20.00
CG		-8.00

Quantity/result
or
Quantity/unit q'ty/@
Result

- The model for the U.S./Canada, use FOR DATE TIME instead of DATE TIME.

Split sales of packaged items

OPERATION

RECEIPT

Item	Unit price	4 for \$10.00
	Quantity	3
	Dept.	1
	Taxable	No
Payment	Cash	\$10.00

FOR DATE TIME
3 FOR DATE TIME
 Quantity being purchased
 (4-digit integer/2-digit decimal)
4 FOR DATE TIME
 Package quantity
 (4-digit integer/2-digit decimal)
1 **0** **00** DATE TIME
 Package price
1 **0** **00** DATE TIME
 SUB TOTAL
 CA/AMT TEND

REG	03-04-2000	09:25
C01	MC#01	000006
3	DEPT01	-7.50
3	@4/ 10.00	-7.50
DEPT01		
TL		-7.50
CASH		-10.00
CG		-2.50

Quantity/result
or
Quantity/unit q'ty/@
Result

- If FOR DATE TIME is not allocated on the keyboard, key allocation is necessary.

Programming department/flat-PLU keys

To program a unit price for each department/flat-PLU

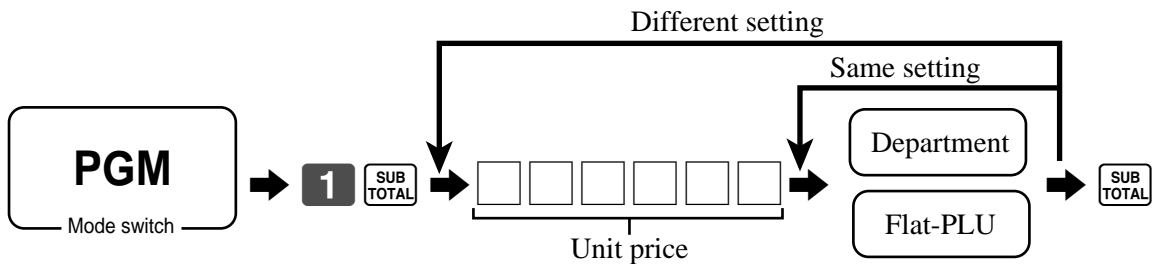

To program the tax calculation status for each department/flat-PLU

Tax calculation status

This specification defines which tax table should be used for automatic tax calculation.

Basic Operations and Setups

Programming procedure

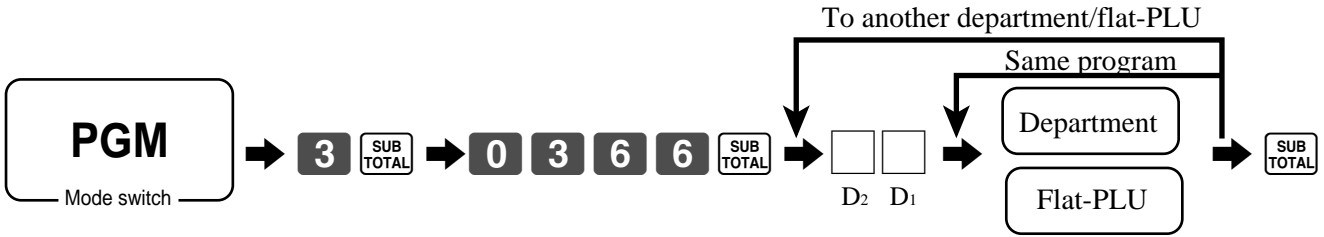

for the U.S./Singapore			
Food stamp (for Singapore, always "0")		Yes = 1 No = 0	<input type="checkbox"/> D ₂
Taxable 1 status	a	Yes = 1 No = 0	<input type="checkbox"/> (a+b+c) D ₁
Taxable 2 status	b	Yes = 2 No = 0	
Taxable 3 status	c	Yes = 4 No = 0	
for Canada			
Donuts status		Yes = 1 No = 0	<input type="checkbox"/> D ₂
Non tax = 0	Taxable 3 = 3	Taxable 1 & 3 = 6	Significant number <input type="checkbox"/> D ₁
Taxable 1 = 1	Taxable 4 = 4	Taxable 1 & 4 = 7	
Taxable 2 = 2	Taxable 1 & 2 = 5		
for other area			
Non tax = 0	Taxable 4 = 4	Taxable 8 = 8	Significant numbers <input type="checkbox"/> <input type="checkbox"/> D ₂ D ₁
Taxable 1 = 1	Taxable 5 = 5	Taxable 9 = 9	
Taxable 2 = 2	Taxable 6 = 6	Taxable 10 = 10	
Taxable 3 = 3	Taxable 7 = 7		

To program high amount limit for each department/flat-PLU

Programming procedure

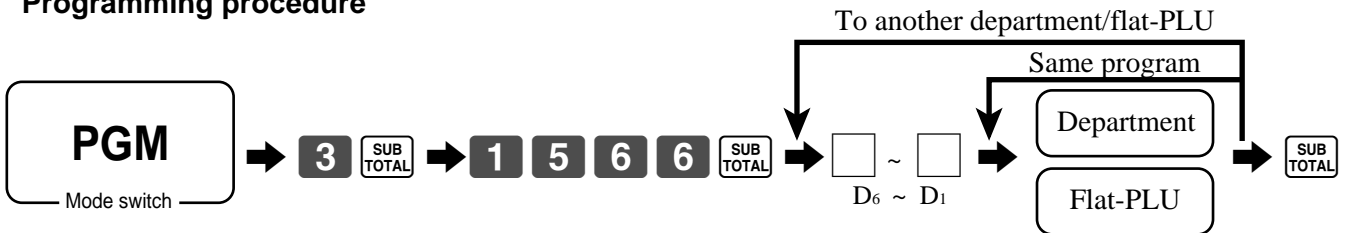

Description	Choice	Program code
High amount limit for entering unit price manually.	Significant numbers	<input type="checkbox"/> <input type="checkbox"/> <input type="checkbox"/> <input type="checkbox"/> D ₆ D ₅ ~ D ₂ D ₁

Registering department/flat-PLU keys by programming data

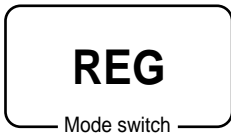

Preset price

OPERATION

Item	Unit price	(\$1.00) _{preset}
	Quantity	1
	Dept.	2
Payment	Cash	\$1.00

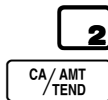

RECEIPT

```
REG 03-04-2000 09:30
C01 MC#01 000007
1 DEPT02      -1.00
TL           -1.00
CASH         -1.00
```

Department No./unit price

Preset tax status

OPERATION

Item 1	Unit price	(\$2.00) _{preset}
	Quantity	5
	Dept.	3
	Taxable	(1) _{preset}
Item 2	Unit price	(\$2.00) _{preset}
	Quantity	1
	Dept.	4
	Taxable	(2) _{preset}
Payment	Cash	\$20.00

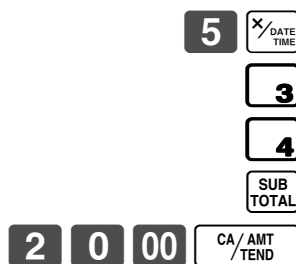

RECEIPT

```
REG 03-04-2000 09:35
C01 MC#01 000008
5 DEPT03 T1 -10.00
1 DEPT04 T2 -2.00
TA1      -10.00
TX1      -0.40
TA2      -2.00
TX2      -0.20
TL       -12.60
CASH     -20.00
CG       -7.40
```

Tax status

Taxable Amount 1

Tax 1

Taxable Amount 2

Tax 2

- The model for the U.S./Canada, use FOR DATE TIME instead of GATE TIME.

Locking out high amount limitation

OPERATION

Item	Unit price	\$1.05
	Quantity	1
	Dept.	3
	Max.amount	(\$10.00) _{preset}
Payment	Cash	\$2.00

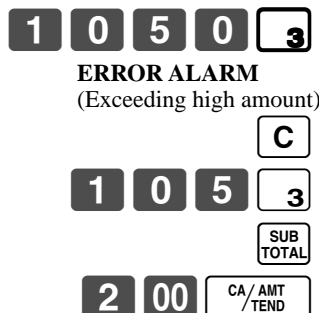

RECEIPT

```
REG 03-04-2000 09:40
C01 MC#01 000009
1 DEPT03      -1.05
TL           -1.05
CASH         -2.00
CG           -0.95
```

Preparing and using PLUs

This section describes how to prepare and use PLUs.

CAUTION:

Before you use PLUs, you must first program the unit price and tax status.

Programming PLUs

To program a unit price for each PLU

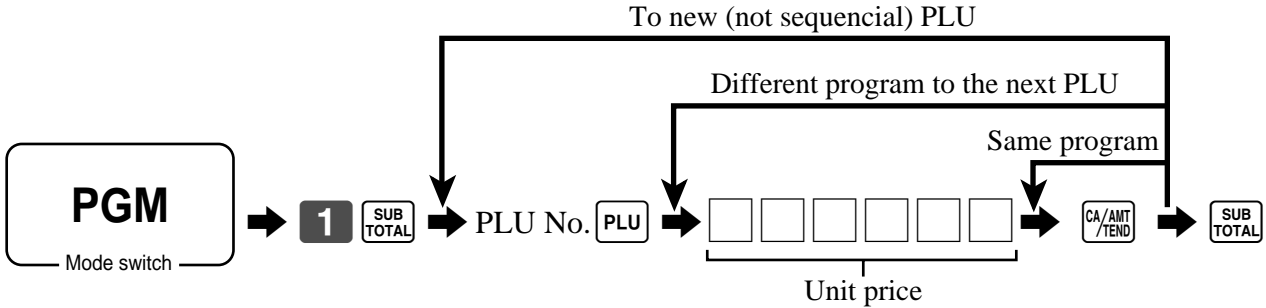

To program tax calculation status for each PLU

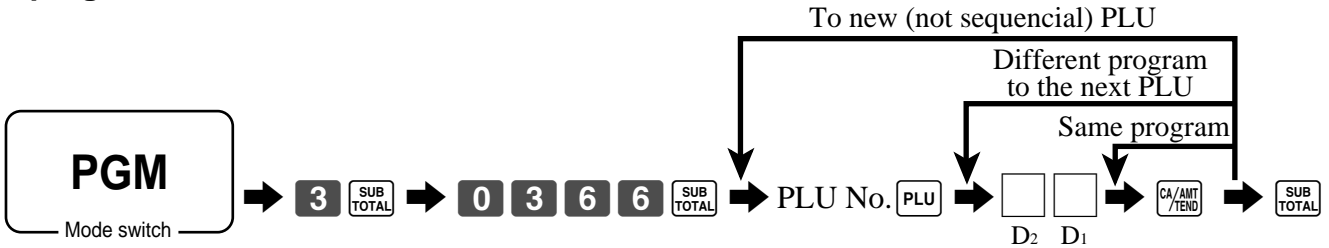

for the U.S./Singapore			
Food stamp (for Singapore, always "0")		Yes = 1 No = 0	<input type="checkbox"/> D ₂
Taxable 1 status	a	Yes = 1 No = 0	<input type="checkbox"/> (a+b+c) D ₁
Taxable 2 status	b	Yes = 2 No = 0	
Taxable 3 status	c	Yes = 4 No = 0	
for Canada			
Donuts status		Yes = 1 No = 0	<input type="checkbox"/> D ₂
Non tax = 0 Taxable 1 = 1 Taxable 2 = 2	Taxable 3 = 3 Taxable 4 = 4 Taxable 1 & 2 = 5	Taxable 1 & 3 = 6 Taxable 1 & 4 = 7	Significant number <input type="checkbox"/> D ₁
for other area			
Non tax = 0 Taxable 1 = 1 Taxable 2 = 2 Taxable 3 = 3	Taxable 4 = 4 Taxable 5 = 5 Taxable 6 = 6 Taxable 7 = 7	Taxable 8 = 8 Taxable 9 = 9 Taxable 10 = 10	Significant numbers <input type="checkbox"/> <input type="checkbox"/> D ₂ D ₁

Registering PLUs

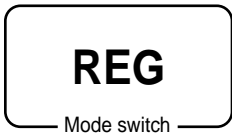

The following examples show how you can use PLUs in various types of registrations.

PLU single item sale

OPERATION

Item	Unit price	(\$2.50) _{preset}
	Quantity	1
	PLU	14
Payment	Cash	\$3.00

1 4
PLU code

PLU

SUB TOTAL

3 00 CA/AMT TEND

RECEIPT

```
REG 03-04-2000 09:45
C01 MC#01 000010
1 PLU0014      -2.50
TL              -2.50
CASH            -3.00
CG              -0.50
```

PLU No./unit price

PLU repeat

OPERATION

Item	Unit price	(\$2.50) _{preset}
	Quantity	3
	PLU	14
Payment	Cash	\$10.00

1 4 **PLU**

PLU

PLU

SUB TOTAL

1 0 00 CA/AMT TEND

RECEIPT

```
REG 03-04-2000 09:50
C01 MC#01 000011
1 PLU0014      -2.50
1 PLU0014      -2.50
1 PLU0014      -2.50
TL              -7.50
CASH           -10.00
CG              -2.50
```

PLU multiplication

OPERATION

Item	Unit price	(\$2.00) _{preset}
	Quantity	10
	PLU	7
Payment	Cash	\$20.00

1 0 **%DATE TIME**
Quantity
(4-digit integer/2-digit decimal)

7 **PLU**

SUB TOTAL

2 0 00 CA/AMT TEND

RECEIPT

```
REG 03-04-2000 09:55
C01 MC#01 000012
10 PLU0007     -20.00
10 @1/ 2.00
PLU0007        -20.00
TL              -20.00
CASH           -20.00
CG              -0.00
```

Quantity/result
or

Quantity/unit q'ty/@
Result

- The model for the U.S./Canada, use **%FOR DATE TIME** instead of **%DATE TIME**.

Basic Operations and Setups

Split sales of packaged item

Item	Unit price	(5for\$20.00) _{preset}
	Quantity	3
	PLU	28
Payment	Cash	\$15.00

3 FOR DATE TIME

Quantity being purchased
(4-digit integer/2-digit decimal)

5 FOR DATE TIME

Package quantity
(4-digit integer/2-digit decimal)

2 8 **PLU**

1 5 00 **CA/AMT TEND**

SUB TOTAL

REG 03-04-2000 10:00
C01 MC#01 000013

3 PLU0028 -12.00

3 @5/ 20.00
PLU0028 -12.00

TL -12.00
CASH -15.00
CG -3.00

Quantity/result
or
Quantity/unit q'ty/@
Result

- If FOR DATE TIME is not allocated on the keyboard, key allocation is necessary.

Open PLU

Item 1	Unit price	\$32.80
	Quantity	1
	PLU	30
Item 2	Unit price	\$13.00
	Quantity	2
	PLU	31
Payment	Cash	\$60.00

3 0 **PLU**

3 2 8 0 **PRICE**

Unit price

3 1 **PLU**

1 3 00 **PRICE**

Repeat **PRICE**

SUB TOTAL

6 0 00 **CA/AMT TEND**

REG 03-04-2000 10:05
C01 MC#01 000014

1 PLU0030 -32.80
1 PLU0031 -13.00
1 PLU0031 -13.00
TL -58.80
CASH -60.00
CG -1.20

- Before registering an open PLU, it is necessary to preset it as an open PLU.

Shifting the taxable status of an item

By pressing "Tax Shift" key, you can shift the taxable status of an item.

REG

Mode switch

Calculation merchandise subtotal

			OPERATION	RECEIPT
Item 1	Dept. 1	\$4.00	4 00 1	<pre> REG 03-04-2000 10:10 C01 MC#01 000015 1 DEPT01 T2 -4.00 1 DEPT02 T1 -2.00 1 DEPT03 T12 -6.00 1 DEPT04 -7.00 TA1 -8.00 TX1 -0.32 TA2 -10.00 TX2 -0.50 TL -19.82 CASH 20.00 CG -0.18 </pre>
	Quantity	1	T/S1	
	Taxable	(2)_{preset}	2 00 2	
Item 2	Dept. 2	\$2.00	Pressing T/S1 changes the tax status from Nontaxable to Taxable 1	
	Quantity	1	T/S2	
	Taxable	(No)→1	6 00 3	
Item 3	Dept. 3	\$6.00	Pressing T/S2 changes the tax status from Taxable 1 to Taxable 1, 2	
	Quantity	1	T/S2	
	Taxable	(1)→1, 2	7 00 4	
Item 4	Dept. 4	\$7.00	Pressing T/S2 changes the tax status from Taxable 2 to Nontaxable	
	Quantity	1	SUB TOTAL	
	Taxable	(2)→No	2 0 00 CA/AMT TEND	
Payment	Cash	\$20.00		

Important!

- To change the tax status of the next item to be registered, be sure to press T/S1, T/S2.
If the last item registered is programmed as nontaxable, a discount (%- key) operation on this item is always nontaxable.
In this case, you cannot manually change the tax status to Taxable 1 or 2 by pressing the T/S1, T/S2 keys.

Preparing and using discounts

This section describes how to prepare and register discounts.

Programming discounts

To program a rate to the **%-** key

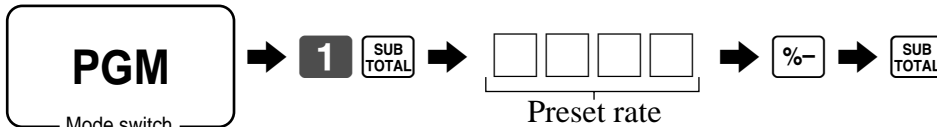

Example:

10% ⇨ **1 0**
 5.5% ⇨ **5 . 5**
 12.34% ⇨ **1 2 . 3 4**

Registering discounts



The following example shows how you can use the **%-** key in various types of registration.

Discount for items and subtotals

	Dept. 1	\$5.00
Item 1	Quantity	1
	Taxable	(1) _{preset}
	PLU 16	(\$10.00) _{preset}
Item 2	Quantity	1
	Taxable	(2) _{preset}
Discount	Rate	(5%)_{preset}
Subtotal discount	Rate	3.5%
	Taxable	Nontaxable
Payment	Cash	\$15.00

OPERATION

5 00 **1**
1 6 **PLU**
%-
 Applies the preset discount rate to the last item registered.
SUB TOTAL
3 . 5 **%-**
 The input value takes priority of the preset value.
SUB TOTAL
1 5 00 **CA/AMT/TEND**

RECEIPT

```
REG 03-04-2000 10:15
C01 MC#01 000016
1 DEPT01 T1 -5.00
1 PLU0016 T2 -10.00
5%
%- T2 -0.50
ST -14.50
3.5%
%- -0.51
TA1 -5.00
TX1 -0.20
TA2 -9.50
TX2 -0.48
TL -14.67
CASH -15.00
CG -0.33
```

- You can manually input rates up to 4 digits long (0.01% to 99.99%).

Taxable status of the **%-** key

- Whenever you perform a discount operation on the last item registered, the tax calculation for discount amount is performed in accordance with the tax status programmed for that item.
- Whenever you perform a discount operation on a subtotal amount, the tax calculation for the subtotal amount is performed in accordance with the tax status programmed for the **%-** key.

Preparing and using reductions

This section describes how to prepare and register reductions.

Programming for reductions

You can use the **[-]** key to reduce single item or subtotal amounts.

To program preset reduction amount

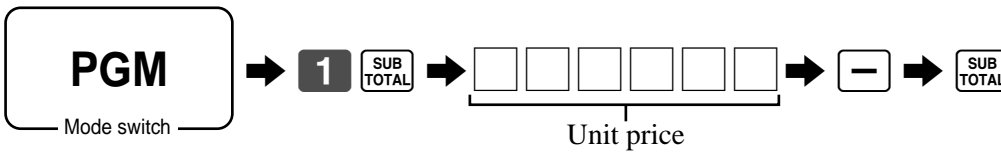

Registering reductions



The following examples show how you can use the **[-]** key in various types of registration.

Reduction for items

			OPERATION	RECEIPT
Item 1	Dept. 1	\$5.00	5 00 1	REG 03-04-2000 10:20 C01 MC#01 000017 1 DEPT01 T1 -5.00 - T1 -0.25 1 PLU0045 T1 -6.00 - T1 -0.50 TA1 -10.25 TX1 -0.41 TL -10.66 CASH -11.00 CG -0.34
	Quantity	1	2 5 [-]	
	Taxable	(1) _{preset}	4 5 PLU	
Reduction	Amount	\$0.25	[-]	
Item 2	PLU 45	(\$6.00) _{preset}	SUB TOTAL	
	Quantity	1	1 1 00 CA/AMT TEND	
	Taxable	(1) _{preset}		
Reduction	Amount	(\$0.50)_{preset}		
Payment	Cash	\$11.00		

- You can manually input reduction values up to 7 digits long.
- If you want to subtract the reduction amount from the department or PLU totalizer, program “Net totaling.”

Basic Operations and Setups

Reduction for subtotal

OPERATION

RECEIPT

Item 1	Dept. 1	\$3.00
	Quantity	1
	Taxable	(1) _{preset}
Item 2	Dept. 2	\$4.00
	Quantity	1
	Taxable	(2) _{preset}
Subtotal Reduction	Amount	\$0.75
	Taxable	(No) _{preset}
Payment	Cash	\$7.00

3 00 **1**

4 00 **2**

SUB TOTAL

7 5 **-**

Reduces the subtotal by the value input here.

SUB TOTAL

7 00 **CA/AMT TEND**

```

REG 03-04-2000 10:25
C01 MC#01 000018
1 DEPT01 T1 -3.00
1 DEPT02 T2 -4.00
- -0.75
TA1 -3.00
TX1 -0.12
TA2 -4.00
TX2 -0.20
TL -6.57
CASH -7.00
CG -0.43
    
```

Registering credit and check payments

The following examples show how to register credits and payments by check.

REG

Mode switch

Check

OPERATION

Item	Dept. 1	\$11.00
	Quantity	1
Payment	Check	\$20.00

1 1 00 1
SUB TOTAL
2 0 00 CHK/TEND

RECEIPT

```
REG 03-04-2000 10:30
C01 MC#01 000019
1 DEPT01 -11.00
TL -11.00
CHECK -20.00
CG -9.00
```

Credit

OPERATION

Item	Dept. 4	\$15.00
	Quantity	1
Reference	Number	1234
Payment	Credit	\$15.00

1 5 00 4
SUB TOTAL
1 2 3 4 #/NS
CRI

RECEIPT

```
REG 03-04-2000 10:35
C01 MC#01 000020
1 DEPT04 -15.00
#/NS 1234
TL -15.00
CREDIT1 -15.00
```

Reference No.

Mixed tender (cash, credit and check)

OPERATION

Item	Dept. 4	\$55.00
	Quantity	1
Payment	Check	\$30.00
	Cash	\$5.00
	Credit	\$20.00

5 5 00 4
SUB TOTAL
3 0 00 CHK/TEND
5 00 CA/AMT TEND
CRI

RECEIPT

```
REG 03-04-2000 10:40
C01 MC#01 000021
1 DEPT04 -55.00
TL -55.00
CHECK -30.00
CASH -5.00
CREDIT1 -20.00
```

Preparing and registering the Euro

Basic programming for the Euro and its exchange rate

Before registering the Euro, you must define the main currency, and its exchange rate.
If you need to select cash drawer or some rounding specification, please ask your dealer.

Description	Choice	Program code
Define the euro as the main currency.	Yes = 0 No = 1	<input type="checkbox"/> D ₁₀
Select rounding option: Round off = 0, Cut off = 1, Round up = 2	Significant number (0 ~ 2)	<input type="checkbox"/> D ₉
Exchange rate (within 6-digits)	Significant numbers	<input type="text"/> <input type="text"/> <input type="text"/> <input type="text"/> <input type="text"/> <input type="text"/> D ₈ D ₇ D ₆ D ₅ D ₄ D ₃
Decimal point position of exchange rate: Integer only = 0 1st decimal place = 1, 2nd decimal place = 2, 3rd decimal place = 3, 4th decimal place = 4, 5th decimal place = 5, 6th decimal place = 6 Example: (D ₈ ~ D ₂) 1Euro = 1.977DM; Set "001977" 1Euro = 1957.77319 Lit; Set "1957772"	Significant number (0 ~ 6)	<input type="checkbox"/> D ₂
Always "0"		<input type="text"/> D ₁



Registering the Euro



The following example shows the basic operation using the currency exchange function.













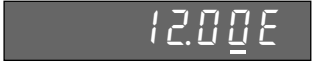

(1) Case A

Main currency	Local
Payment	Euro
Change	Local
Rate	1 Euro = 0.5 FFr













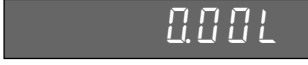

(2) Case B

Main currency	Euro
Payment	Local
Change	Euro
Rate	1 Euro = 0.5 FFr

Case A

OPERATION	DISPLAY
<p>6 0 0 </p> <p> ← Press the  key, which converts the subtotal amount into the sub currency by applying the preset exchange rate.</p> <p> After you press the  key, the result is shown on the display.</p>	 
<p>1 5 00 </p> <p>← Press the  key if you enter the payment in the sub currency.</p>	 
<p> ← Press the  key to finalize the transaction.</p> <p>The change amount is shown in the programmed currency.</p>	

Case B

OPERATION	DISPLAY
<p>1 2 00 </p> <p> ← Press the  key, which converts the subtotal amount into the sub currency by applying the preset exchange rate.</p> <p> After you press the  key, the result is shown on the display.</p>	 
<p>6 00 </p> <p>← Press the  key if you enter the payment in the sub currency.</p>	 
<p> ← Press the  key to finalize the transaction.</p> <p>The change amount is shown in the programmed currency.</p>	

Printouts

CASE A

```

REG 03-04-2000 10:45
C01 MC#01 000022

1 DEPT01      -6.00
TL            -6.00
              €12.00

EURO money
CASH          €15.00
CASH          -7.50
CG            -1.50
    
```

CASE B

```

REG 03-04-2000 10:50
C01 MC#01 000023

1 DEPT01      €12.00
TL            €12.00
              -6.00

LOCAL money
CASH          -6.00
CASH          €12.00
CG            €0.00
    
```

Basic Operations and Setups

Validation printing

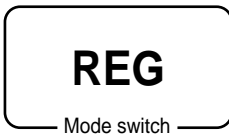

You can perform total amount validation following finalization using **CA/AMT/TEND**, **CH**, **CHK/TEND**, **CR1**, **CR2** keys and **RC**, **PD** keys. Also you can perform single item validation.

Total amount validation

Item	Dept. 1	\$14.00
	Quantity	1
Payment	Check	\$20.00
Validation		

1 4 00 **1**

2 0 00

SUB TOTAL

CHK/TEND

REG 03-04-2000 10:55
 C01 MC#01 000024

1 DEPT01 -14.00
 TL -14.00
 CHECK -20.00
 CG -6.00

- ① Open the journal window.
- ② Insert paper.
- ③ Press **VALID**.

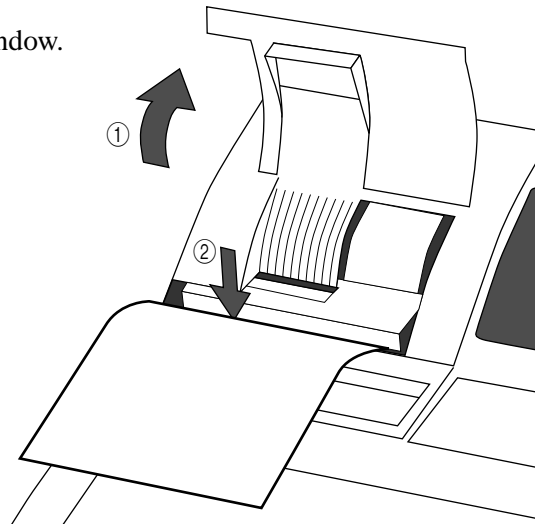

Validation sample

135 mm ~ 210 mm

70 mm Min.

Format A REG C01 030400 1055 MC#01 000024 CHECK -14.00

Format B REG C01 030400 1055 MC#01 024 CHECK -14.00

Mode (4 digits)

Clerk name (6 digits)

Date (6 digits), Time (4 digits)

Machine/Cons. No. (6 digits ea.)

Key descriptor

Amount

Registering returned goods in the REG mode



The following example shows how to use the **RF** key in the REG mode to register goods returned by customers.

OPERATION

Item 1	Dept. 1	\$2.35
	Quantity	1
Item 2	Dept. 2	\$2.00
	Quantity	1
Item 3	PLU 1	(\$1.20) _{preset}
	Quantity	1
Returned Item 1	Dept. 1	\$2.35
	Quantity	1
Returned Item 3	PLU 1	(\$1.20) _{preset}
	Quantity	1
Payment	Cash	\$2.00

2 3 5 1
2 00 2
1 PLU
RF
2 3 5 1
 Press **RF** before the item you want to return.
RF
1 PLU
SUB TOTAL
CA/AMT /TEND

RECEIPT

```

REG 03-04-2000 11:00
C01 MC#01 000025

1 DEPT01      -2.35
1 DEPT02      -2.00
1 PLU0001     -1.20
RF           .....
1 DEPT01      -2.35
RF           .....
1 PLU0001     -1.20
TL           -2.00
CASH          -2.00
    
```

Registering returned goods in the RF mode

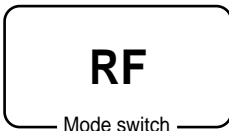

The following examples show how to use the RF mode to register goods returned by customers.

Normal refund transaction

OPERATION

Returned Item 1	Dept. 1	\$1.50
	Quantity	2
Returned Item 2	PLU 2	(\$1.20) _{preset}
	Quantity	6
Payment	Cash	\$10.20

1 5 0 1
1
6 X/DATE TIME
2 PLU
CA/AMT /TEND

RECEIPT

```

RF 03-04-2000 11:05
C01 MC#01 000026

1 DEPT01      -1.50
1 DEPT01      -1.50
6 PLU0002     -7.20
TL           -10.20
CASH          -10.20
    
```

RF mode symbol

- The model for the U.S./Canada, use **X/DATE TIME** instead of **X/DATE TIME**.

Basic Operations and Setups

Reduction of amounts paid on refund

OPERATION			RECEIPT
Returned Item 1	Dept. 3	\$4.00	<pre>RF 03-04-2000 11:10 C01 MC#01 000027 1 DEPT03 T1 -4.00 - T1 -0.15 1 PLU0002 T2 -1.20 5% %- T2 -0.06 TA1 -3.85 TX1 -0.15 TA2 -1.14 TX2 -0.06 TL -5.20 CASH -5.20</pre>
	Quantity	1	
Reduction	Amount	\$0.15	
Returned Item 2	PLU 2	(\$1.20) _{preset}	
	Quantity	1	
Discount	Rate	(5%) _{preset}	
Payment	Cash	\$5.20	

4 00 3

1 5 -

2 PLU

%-

SUB TOTAL

CA/AMT /TEND

Important!

- To avoid miss registrations in the RF mode, return the mode switch to the former position immediately.

Registering money received on account



The following example shows how to register money received on account. This registration must be performed out of a sale.

OPERATION		RECEIPT
Received amount	\$700.00	<pre>REG 03-04-2000 11:15 C01 MC#01 000028 RC -700.00</pre>

7 00 00 RC

Amount can be up to 8 digits.

Registering money paid out



The following example shows how to register money paid out from the register. This registration must be performed out of a sale.

OPERATION		RECEIPT
Paid out amount	\$1.50	<pre>REG 03-04-2000 11:20 C01 MC#01 000029 PD -1.50</pre>

1 5 0 PD or PD

Amount can be up to 8 digits.

Registering loan amounts

Use this procedure to register loan or bank received from the office.

REG

Mode switch

OPERATION

RECEIPT

Item	Note	\$1.00
	Quantity	10
	Note	\$5.00
	Quantity	5
Media	Cash	\$35.00

DATE TIME
1 0 DATE TIME
1 00 **LOAN**
5 DATE TIME
5 00 **LOAN**
 CA/AMT/TEND

REG	03-04-2000	11:25
C01	MC#01	000030
LOAN		+10.00
LOAN		+25.00
CASH		+35.00

- The model for the U.S./Canada, use FOR DATE TIME instead of DATE TIME.

Registering pick up amounts

Use this procedure to register pick up money from cash drawer.

REG

Mode switch

OPERATION

RECEIPT

Item	Coin	\$0.50
	Quantity	10
	Coin	\$0.10
	Quantity	5
Media	Cash	\$5.50

DATE TIME
1 0 DATE TIME
5 0 **PICK UP**
5 DATE TIME
1 0 **PICK UP**
 CA/AMT/TEND

REG	03-04-2000	11:30
C01	MC#01	000031
P.UP		+5.00
P.UP		+0.50
CASH		+5.50

- The model for the U.S./Canada, use FOR DATE TIME instead of DATE TIME.

Changing media in drawer

Use this procedure to change media in drawer.

REG

Mode switch

OPERATION

RECEIPT

Media	Check	-10.00
	Cash	\$8.00
	Charge	\$2.00

MEDIA CHANGE
1 0 00 CHK/TEND
 Enter the amount to be changed.
8 00 CA/AMT/TEND
2 00 **CH**

REG	03-04-2000	11:35
C01	MC#01	000032
MEDIA CHG	
CHECK		-10.00
CASH		+8.00
CH		+2.00

Making corrections in a registration

REG

Mode switch

There are three techniques you can use to make corrections in a registration.

- To correct an item that you input but not yet registered.
- To correct the last item you input and registered.
- To cancel all items in a transaction.

To correct an item you input but not yet registered

OPERATION

RECEIPT

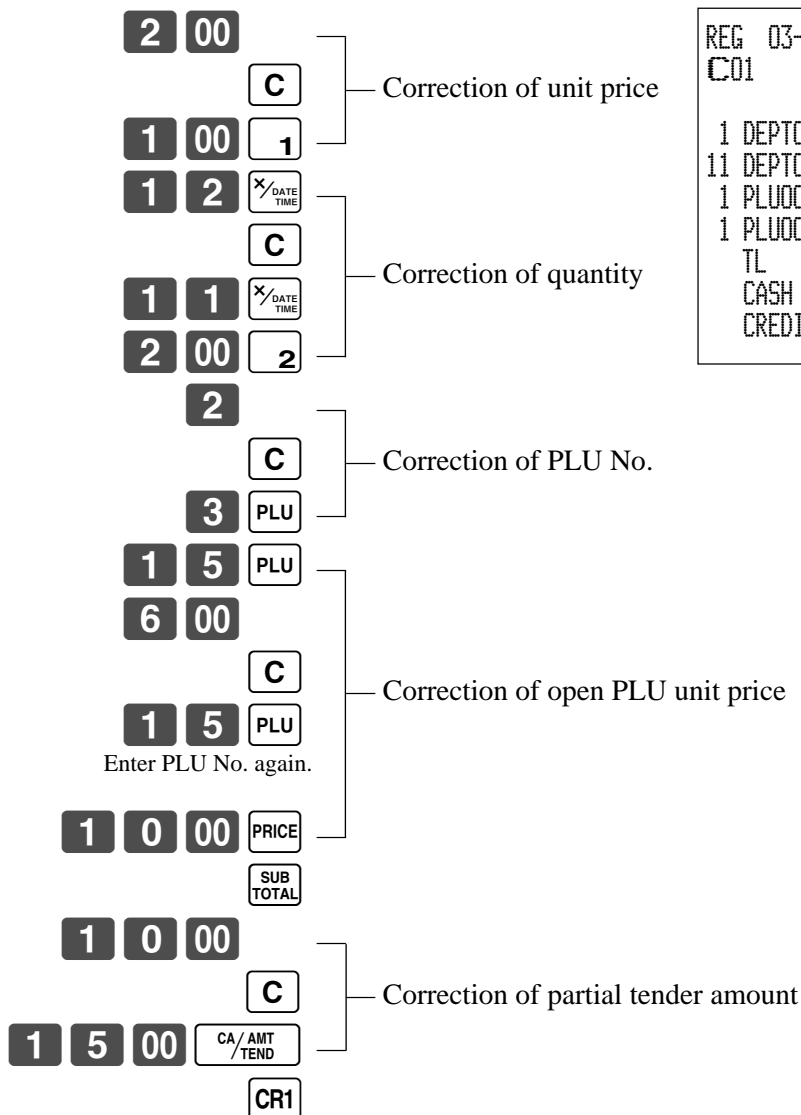

REG	03-04-2000	11:40
C01	MC#01	000033
1	DEPT01	-1.00
11	DEPT02	-22.00
1	PLU0003	-1.30
1	PLU0015	-10.00
	TL	-34.30
	CASH	+15.00
	CREDIT1	+19.30

- The model for the U.S./Canada, use instead of .

To correct an item you input and registered

OPERATION

RECEIPT

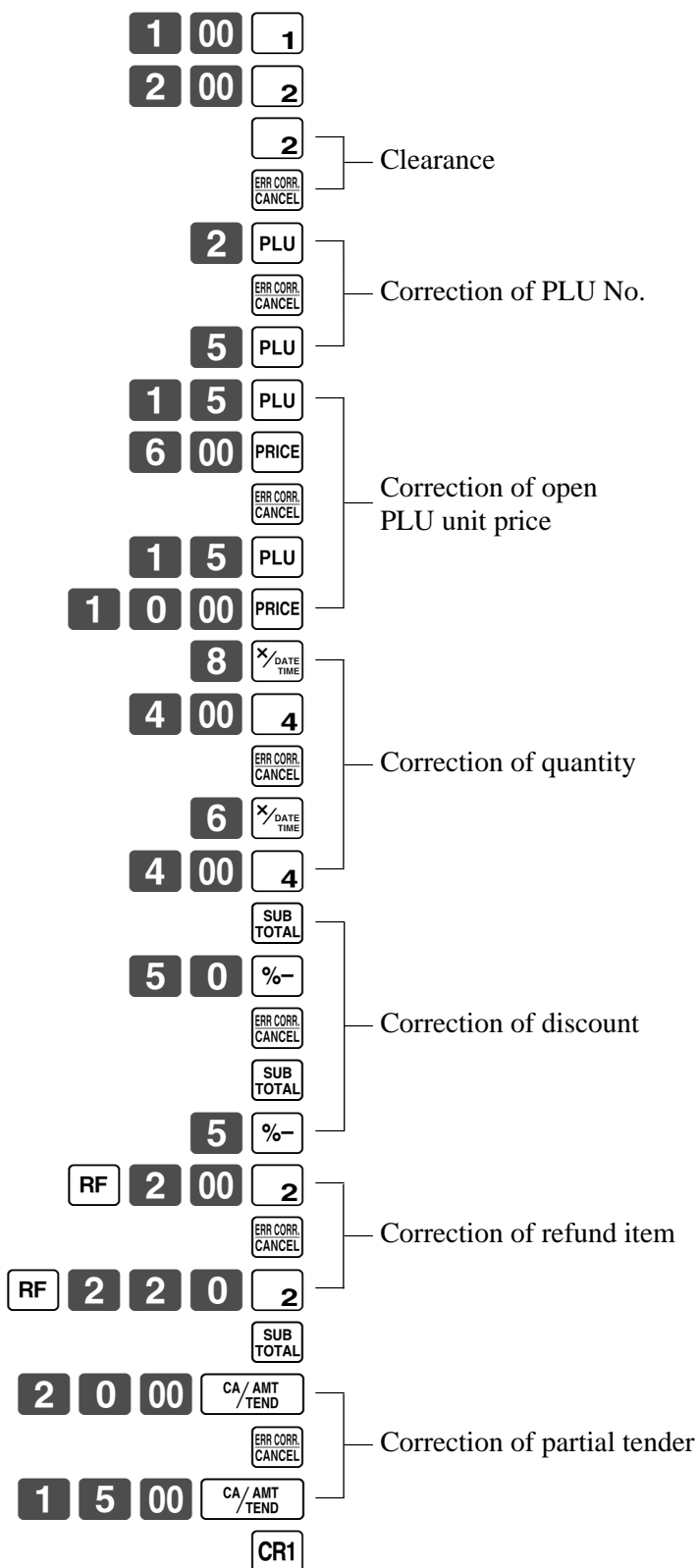

REG	03-04-2000	11:45
C01	MC#01	000034
1	DEPT01	-1.00
1	DEPT02	-2.00
1	DEPT02	-2.00
	CORR	-2.00
1	PLU0002	-1.20
	CORR	-1.20
1	PLU0005	-1.50
1	PLU0015	-6.00
	CORR	-6.00
1	PLU0015	-10.00
8	DEPT04	-32.00
	CORR	-32.00
6	DEPT04	-24.00
	ST	-38.50
	50%	
	%-	-19.25
	CORR	-19.25
	ST	-38.50
	5%	
	%-	-1.93
	RF
1	DEPT02	-2.00
	CORR	-2.00
	RF
1	DEPT02	-2.20
	TL	-34.37
	CASH	-20.00
	CORR	-20.00
	CASH	-15.00
	CREDIT1	-19.37

• The model for the U.S./Canada, use FOR DATE TIME instead of DATE TIME.

Basic Operations and Setups

To cancel all items in a transaction

OPERATION	RECEIPT
<div style="display: flex; flex-direction: column; align-items: center;"> <div style="display: flex; gap: 5px;"> <div style="border: 1px solid black; padding: 2px 5px;">1</div> <div style="border: 1px solid black; padding: 2px 5px;">00</div> <div style="border: 1px solid black; padding: 2px 5px;">1</div> </div> <div style="display: flex; gap: 5px;"> <div style="border: 1px solid black; padding: 2px 5px;">2</div> <div style="border: 1px solid black; padding: 2px 5px;">00</div> <div style="border: 1px solid black; padding: 2px 5px;">2</div> </div> <div style="display: flex; gap: 5px;"> <div style="border: 1px solid black; padding: 2px 5px;">3</div> <div style="border: 1px solid black; padding: 2px 5px;">00</div> <div style="border: 1px solid black; padding: 2px 5px;">3</div> </div> <div style="display: flex; gap: 5px;"> <div style="border: 1px solid black; padding: 2px 5px;">4</div> <div style="border: 1px solid black; padding: 2px 5px;">00</div> <div style="border: 1px solid black; padding: 2px 5px;">4</div> </div> <div style="border: 1px solid black; padding: 2px 5px; margin-top: 5px;">SUB TOTAL</div> </div>	<div style="border: 1px solid black; padding: 5px;"> <pre> REG 03-04-2000 11:50 C01 MC#01 000035 1 DEPT01 -1.00 1 DEPT02 -2.00 1 DEPT03 -3.00 1 DEPT04 -4.00 CANCEL </pre> </div>
<p>Pressing SUB TOTAL key is necessary to cancel the transaction.</p> <div style="border: 1px solid black; padding: 2px 5px; margin-top: 10px; width: fit-content;">ERR CORR. CANCEL</div>	

No sale registration



You can use the following procedure to open the drawer without registering a sale. This operation must be performed out of a sale.

OPERATION	RECEIPT
<div style="border: 1px solid black; padding: 2px 5px; display: inline-block; margin-top: 20px;"># NS</div>	<div style="border: 1px solid black; padding: 5px;"> <pre> REG 03-04-2000 11:55 C01 MC#01 000036 # / NS </pre> </div>

Printing the daily sales reset report

This report shows daily sales totals.

OPERATION		REPORT	
<div style="border: 1px solid black; padding: 5px; display: inline-block;"> Z1 <small>Mode switch</small> </div>			
<div style="border: 1px solid black; padding: 2px; display: inline-block; margin-top: 10px;"> <small>CA / AMT / TEND</small> </div>			
Z 03-04-2000 17:00	Date/time	CHARGE No 56	-1,174.85
C01 MCH01 000231	Clerk name/mc No./consecutive No.	RC No 4	-810.00
Z BATCH01	Report title	PD No 5	-520.00
Z FIX 0001	Fixed total report title/reset counter	CORP No 14	-5.00
0001011	Report code		-39.55
GROSS 981.25	Gross total *2	ULD No 19	
-6,574.40		RCT No 3	
NET No 111	Net total *2	NS No 5	
-7,057.14		Z DEPT 0001	Department report title/reset counter
CAID -1,919.04	Cash in drawer *2	0001015	Report code
CHID -139.04	Charge in drawer *2	DEPT01 203.25	Department count/amount *1
CKID -859.85	Check in drawer *2	DEPT02 183	
CRID(1) -709.85	Credit in drawer *2	-1,362.26	
RF No 3	Refund mode *2	DEPT04	
-10.22			-17.22
CUST CT 111	Number of customer *2	TL 421.25	Department total count/total amount
AVRG -63.57	Average sales per customer *2	-2,872.28	
DC -1.22	Discount total *2	Z CASHIER 0001	Clerk report title/reset counter
REF -2.42	Refund key *2	0001017	Report code
CLEAR No 85	Clear key count *2	C011	Clerk name/drawer No. *1
ROUND -0.00	Rounding total *2	GROSS 421.25	Gross total *1
CANCEL No 2	Cancellation *2	-2,872.28	
-12.97		NET No 111	Net total *1
TA1 -2,369.69	Taxable 1 amount *2	-1,845.35	
TX1 -128.86	Tax 1 amount *2	CAID -1,057.14	Cash in drawer *1
TA2 -2,172.96	Taxable 2 amount *2	CHID -139.04	
TX2 -217.33	Tax 2 amount *2	RF No 1	Refund mode *1
GT1 -00000000125478.96	Grand total 1 *2	-1.00	
GT2 -00000000346284.23	Grand total 2 *2	CLEAR No 5	Clear key count *1
GT3 -00000000123212.75	Grand total 3 *2	-4.43	
Z TRANS 0001	Function key report title/reset counter	C021	Clerk name/drawer No.
0001012	Report code		
CASH No 362	Function key count/amount *1		
-1,638.04			

*1 Zero totalled departments/functions/clerks are not printed by programming.

*2 These items can be skipped by programming.

This chapter describes more sophisticated operations that you can use to suit the needs of your retail environment.

Stock check

Each PLU has an actual stock totalizer that you can program with a minimum stock quantity. Then the register checks actual stock quantities against the programmed minimum stock quantities. Stock operations are performed only for PLUs (except scanning PLUs) programmed with minimum stock quantities.

Stock warnings

The cash register checks for negative values in actual stock quantities during the registration itself. After registration is complete, it checks actual stock quantities against minimum stock quantities. The following warning indicators are used to inform the operator of any problem.

- **Negative stock:**

This indicates that the actual stock quantity is negative. You can also program the cash register to treat this condition as an error. This warning does not appear when the actual stock quantity is zero.

- **Under minimum stock:**

This indicates that the actual stock quantity is less than or equal to the minimum stock quantity. The cash register can be programmed so that a buzzer sounds when the actual stock quantity is less than the minimum stock quantity.

Notes

- The stock check operation is also performed for PLUs programmed with minimum stock quantities that make up set menus.
- None of the warning indicators appear unless the cash register is specifically programmed for the stock check operation.
- Stock operations can be performed for registrations in the RF mode or those performed with <REFUND> (the refund key).
- An error correct, void, or cancel operation restores the original of items in stock value.

Clerk interrupt function

There are two types of clerk interrupt function, illustrated by PROCEDURE 1 and PROCEDURE 2 below.

- In PROCEDURE 1, each clerk possesses a unique clerk interrupt buffer, and so the clerk interrupt function gives each individual clerk the ability to perform an independent registration operation. In this case, each clerk is individually linked to a unique clerk interrupt buffer.
- In PROCEDURE 2, multiple clerks use the same clerk interrupt buffer, and so a single clerk interrupt operation (clerk change during registration) can be performed any registration is in progress. In this case, multiple clerks are linked to a single clerk interrupt buffer.

Note the following important points concerning the clerk interrupt function.

- The register must be programmed to allow use of the clerk interrupt function.
- To use the clerk interrupt function, a clerk interrupt buffer must first be allocated with the memory allocation operation. Next the manager control operation (X1 mode) should be used to perform clerk assignment for the clerk interrupt function. The clerk interrupt operation cannot be performed by clerks who are not linked to a clerk interrupt buffer.
- You cannot use the clerk interrupt function on a register set up to function as part of a check tracking system. In the REG1, REG2, and RF modes, clerks can change while a transaction is in progress, making it possible for multiple clerks to simultaneously perform registrations using a single register. For example, if clerk 1 is interrupted while registering a transaction, clerk 2 can use the same machine to register a different transaction. Then clerk 1 can continue the original registration from the point where it was interrupted.

PROCEDURE 1



PROCEDURE 2

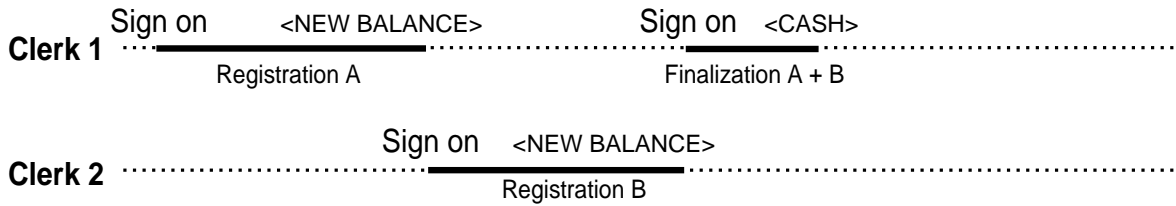

NOTES

- A guest receipt can be issued following clerk change, and receipts can be issued separately for each clerk.
- A cancel operation can be performed during registration by either of the clerks. When clerk 1 signs back on (after being interrupt by clerk 2), the cancel operation cancels only the items registered after signing back on (only this receipt) or from the top of the transaction. This is selectable by the key program.

Single item cash sales

A department key or PLU programmed with single item sale status finalizes the transaction as soon as it is registered.
 The single item sales function cannot work properly if the keyboard does not include <CASH> (the cash key).
 The single item sales function can only be used for cash sales.

Example 1

	OPERATION	RECEIPT																						
<table border="1" style="width: 100%; border-collapse: collapse;"> <tr> <td style="width: 15%;">Item</td> <td style="width: 15%;">Dept. 1</td> <td style="width: 15%;">\$1.00</td> </tr> <tr> <td></td> <td>Quantity</td> <td>1</td> </tr> <tr> <td></td> <td>Status</td> <td>S.I.S</td> </tr> <tr> <td>Payment</td> <td>Cash</td> <td>\$1.00</td> </tr> </table>	Item	Dept. 1	\$1.00		Quantity	1		Status	S.I.S	Payment	Cash	\$1.00	<div style="font-size: 24px; font-weight: bold; margin-bottom: 5px;">1 00 1</div> <p>The transaction is immediately finalized.</p>	<table border="1" style="width: 100%; border-collapse: collapse;"> <tr> <td style="width: 60%;">REG 03-04-2000 13:00</td> <td style="width: 40%;">Mode/date/time</td> </tr> <tr> <td>C01 MC#01 000101</td> <td>Clerk/consecutive No.</td> </tr> <tr> <td>1 DEPT01 .1.00</td> <td>Department No./unit price</td> </tr> <tr> <td>TL - 1 .00</td> <td>Cash total amount</td> </tr> <tr> <td>CASH .1.00</td> <td></td> </tr> </table>	REG 03-04-2000 13:00	Mode/date/time	C01 MC#01 000101	Clerk/consecutive No.	1 DEPT01 .1.00	Department No./unit price	TL - 1 .00	Cash total amount	CASH .1.00	
Item	Dept. 1	\$1.00																						
	Quantity	1																						
	Status	S.I.S																						
Payment	Cash	\$1.00																						
REG 03-04-2000 13:00	Mode/date/time																							
C01 MC#01 000101	Clerk/consecutive No.																							
1 DEPT01 .1.00	Department No./unit price																							
TL - 1 .00	Cash total amount																							
CASH .1.00																								

Advanced Operations

Example 2

	OPERATION	RECEIPT												
<table border="1" style="width: 100%; border-collapse: collapse;"> <tr> <td style="width: 15%;"></td> <td style="width: 15%;">Dept. 1</td> <td style="width: 70%;">(\$1.00)</td> </tr> <tr> <td>Item</td> <td>Quantity</td> <td>3</td> </tr> <tr> <td></td> <td>Status</td> <td>S.I.S</td> </tr> <tr> <td>Payment</td> <td>Cash</td> <td>\$3.00</td> </tr> </table>		Dept. 1	(\$1.00)	Item	Quantity	3		Status	S.I.S	Payment	Cash	\$3.00	<div style="display: flex; justify-content: space-around; align-items: center;"> 3 X/DATE TIME </div> <div style="display: flex; justify-content: space-around; align-items: center; margin-top: 10px;"> 1 X/DATE TIME </div> <p>The transaction is immediately finalized.</p>	<div style="border: 1px solid black; padding: 5px; width: fit-content; margin: auto;"> REG 03-04-2000 13:05 C01 MC#01 000102 3 DEPT01 -3.00 TL -3.00 CASH -3.00 </div>
	Dept. 1	(\$1.00)												
Item	Quantity	3												
	Status	S.I.S												
Payment	Cash	\$3.00												

- The model for the U.S./Canada, use X/FOR
DATE
TIME instead of X/DATE
TIME.

Example 3

	OPERATION	RECEIPT																					
<table border="1" style="width: 100%; border-collapse: collapse;"> <tr> <td style="width: 15%;"></td> <td style="width: 15%;">Dept. 3</td> <td style="width: 70%;">\$2.00</td> </tr> <tr> <td>Item 1</td> <td>Quantity</td> <td>1</td> </tr> <tr> <td></td> <td>Status</td> <td>Normal</td> </tr> <tr> <td>Item 2</td> <td>Dept. 1</td> <td>\$1.00</td> </tr> <tr> <td></td> <td>Quantity</td> <td>1</td> </tr> <tr> <td></td> <td>Status</td> <td>S.I.S</td> </tr> <tr> <td>Payment</td> <td>Cash</td> <td>\$3.00</td> </tr> </table>		Dept. 3	\$2.00	Item 1	Quantity	1		Status	Normal	Item 2	Dept. 1	\$1.00		Quantity	1		Status	S.I.S	Payment	Cash	\$3.00	<div style="display: flex; justify-content: space-around; align-items: center;"> 2 00 3 </div> <div style="display: flex; justify-content: space-around; align-items: center; margin-top: 10px;"> 1 X/DATE TIME </div> <p>The transaction is not finalized. Because another item is registered before the single item sales department.</p> <div style="display: flex; justify-content: center; align-items: center; margin-top: 10px;"> CA/AMT TEND </div>	<div style="border: 1px solid black; padding: 5px; width: fit-content; margin: auto;"> REG 03-04-2000 13:10 C01 MC#01 000103 1 DEPT03 -2.00 1 DEPT01 -1.00 TL -3.00 CASH -3.00 </div>
	Dept. 3	\$2.00																					
Item 1	Quantity	1																					
	Status	Normal																					
Item 2	Dept. 1	\$1.00																					
	Quantity	1																					
	Status	S.I.S																					
Payment	Cash	\$3.00																					

Addition

Addition (plus)

Example

	OPERATION	RECEIPT																					
<table border="1" style="width: 100%; border-collapse: collapse;"> <tr> <td style="width: 15%;"></td> <td style="width: 15%;">Dept. 1</td> <td style="width: 70%;">\$1.00</td> </tr> <tr> <td>Item 1</td> <td>Quantity</td> <td>1</td> </tr> <tr> <td></td> <td>Addition</td> <td>\$0.10</td> </tr> <tr> <td>Item 2</td> <td>Dept. 1</td> <td>\$2.00</td> </tr> <tr> <td></td> <td>Quantity</td> <td>3</td> </tr> <tr> <td></td> <td>Addition</td> <td>3 × (\$0.20)</td> </tr> <tr> <td>Payment</td> <td>Cash</td> <td>\$7.70</td> </tr> </table>		Dept. 1	\$1.00	Item 1	Quantity	1		Addition	\$0.10	Item 2	Dept. 1	\$2.00		Quantity	3		Addition	3 × (\$0.20)	Payment	Cash	\$7.70	<div style="display: flex; justify-content: space-around; align-items: center;"> 1 00 1 </div> <div style="display: flex; justify-content: space-around; align-items: center; margin-top: 10px;"> 1 0 + </div> <div style="display: flex; justify-content: space-around; align-items: center; margin-top: 10px;"> 3 X/DATE TIME </div> <div style="display: flex; justify-content: space-around; align-items: center; margin-top: 10px;"> 2 00 1 </div> <div style="display: flex; justify-content: space-around; align-items: center; margin-top: 10px;"> 3 X/DATE TIME </div> <div style="display: flex; justify-content: center; align-items: center; margin-top: 10px;"> + </div> <div style="display: flex; justify-content: center; align-items: center; margin-top: 10px;"> CA/AMT TEND </div>	<div style="border: 1px solid black; padding: 5px; width: fit-content; margin: auto;"> REG 03-04-2000 13:15 C01 MC#01 000104 1 DEPT01 -1.00 + -0.10 3 DEPT01 -6.00 + -0.60 TL -7.70 CASH -7.70 </div>
	Dept. 1	\$1.00																					
Item 1	Quantity	1																					
	Addition	\$0.10																					
Item 2	Dept. 1	\$2.00																					
	Quantity	3																					
	Addition	3 × (\$0.20)																					
Payment	Cash	\$7.70																					

- The model for the U.S./Canada, use X/FOR
DATE
TIME instead of X/DATE
TIME.

Premium (%+)

Example

OPERATION			RECEIPT			
Item 1	Dept. 1	\$1.00	1	00	1	REG 03-04-2000 13:20 C01 MC#01 000105 1 DEPT01 -1.00 10% %+ -0.10 3 DEPT01 -6.00 ST -7.10 15% %+ -1.07 TL -8.17 CASH -8.17
	Quantity	1	1	0	%+	
	Premium	10%	3	%DATE	TIME	
Item 2	Dept. 1	\$2.00	2	00	1	
	Quantity	3	SUB TOTAL			
Subtotal Premium	(15%)	%+				
Payment	Cash	\$8.17	CA / AMT / TEND			

- The model for the U.S./Canada, use FOR DATE TIME instead of DATE TIME.

Tray total

Tray total premium/discount

The buffer memory stores all items that fall into the prescribed range, starting from the first item registered for a transaction up to the point that <TRAY TOTAL> (the tray total key) is pressed to perform a tray total premium/discount operation. Following a premium/discount operation, the buffer is cleared and storage of new data starts from registration of the next item following the first premium/discount operation. The following operations clear the buffer memory.

- Press <TRAY TOTAL> twice.
- Press <TRAY TOTAL> and then perform a premium/discount operation. The contents of the buffer memory are restored if an error correction operation is performed to delete the premium/discount operation.

Example

OPERATION			RECEIPT				
Group 1	Dept. 1	\$1.00	1	00	1	REG 03-04-2000 13:25 C01 MC#01 000106 1 DEPT01 -1.00 1 DEPT03 -2.00 TRAY TL -3.00 5% %- -0.15 1 DEPT03 -3.00 1 DEPT04 -4.00 TRAY TL -7.00 10% %- -0.70 TL -9.15 CASH -9.15	
	Dept. 3	\$2.00	2	00	3		
	Discount	(5%) _{preset}					TRAY TOTAL
Group 2	Dept. 3	\$3.00	3	00	3		%-
	Dept. 4	\$4.00	4	00	4		
	Discount	10%					TRAY TOTAL
Payment	Cash	\$9.15	1	0	%-		
						CA/AMT/TEND	

Multiple item totalling function

This function accumulates all items registered from the first item registered up to point that <TRAY TOTAL> is pressed, or all items between two presses of <TRAY TOTAL>. Pressing <TRAY TOTAL> displays the total amount with the tax included and prints it on the receipt and journal (printing on receipt and journal is programmable.)

Example

OPERATION			RECEIPT				
CustomerA	Dept. 1	\$1.00	1	00	1	REG 03-04-2000 13:30 C01 MC#01 000107 1 DEPT01 -1.00 1 DEPT03 -2.00 TRAY TL -3.00 1 DEPT03 -3.00 1 DEPT04 -4.00 TRAY TL -7.00 TL -10.00 CASH -10.00	
	Dept. 3	\$2.00	2	00	3		
CustomerB	Dept. 3	\$3.00	3	00	3		TRAY TOTAL
	Dept. 4	\$4.00	4	00	4		%-
Payment	Cash	\$10.00					TRAY TOTAL
							CA/AMT/TEND

Coupon transactions

Note that errors result when the result of a calculation is negative if the cash register is programmed to prohibit credit balances.

Coupon registration using <COUPON> (coupon key)

Example

			OPERATION	RECEIPT
Item 1	Dept. 1	\$3.00	2 <input type="checkbox"/> DATE TIME 3 00 <input type="checkbox"/> 1 2 <input type="checkbox"/> DATE TIME 5 0 <input type="checkbox"/> CPN 4 00 <input type="checkbox"/> 3 <input type="checkbox"/> CPN <input type="checkbox"/> CA/AMT /TEND	<pre> REG 03-04-2000 13:35 C01 MC#01 000108 2 DEPT01 +6.00 CPN -1.00 1 DEPT03 +4.00 CPN -1.00 TL -8.00 CASH +8.00 </pre>
	Quantity	2		
	Coupon	\$0.50 × 2		
Item 2	Dept. 3	\$4.00		
	Quantity	1		
	Coupon	(\$1.00)		
Payment	Cash	\$8.00		

- The model for the U.S./Canada, use FOR DATE TIME instead of DATE TIME.

Coupon registration using <COUPON2> (coupon 2 key)

Example

			OPERATION	RECEIPT
Item 1	Dept. 1	\$15.00	<input type="checkbox"/> CPN2 1 5 00 <input type="checkbox"/> 1 <input type="checkbox"/> CPN2 1 5 0 <input type="checkbox"/> 1 1 0 <input type="checkbox"/> PLU <input type="checkbox"/> CPN2 5 0 <input type="checkbox"/> PLU <input type="checkbox"/> CA/AMT /TEND	<pre> REG 03-04-2000 13:40 C01 MC#01 000109 1 DEPT01 +15.00 CPN2 +..... 1 DEPT01 -1.50 1 PLU0010 +5.00 CPN2 +..... 1 PLU0050 -0.50 TL -18.00 CASH +18.00 </pre>
	Quantity	1		
	Coupon 2 Dept. 1	\$1.50		
Item 2	PLU 10	\$5.00		
	Quantity	1		
	Coupon 2 PLU 50	(\$0.50)		
Payment	Cash	\$18.00		

Registering the second unit price

Second unit prices along with quantity modifiers can be programmed to PLUs. Pressing <PRICE SHIFT> (price shift key) calls up the second unit price, quantity modifier, and descriptor. Totalizers and inventory are adjusted by multiplying the number of items being registered by the quantity modifier programmed to the PLU being registered.

- <PRICE SHIFT> must be pressed before each registration of a PLU.
- Second unit price registration is no available with open PLUs when unit price is not preset.
- Second unit prices and quantity modifiers are assigned to PLUs using programming procedures described in the dealer's manual.
- Even if a PLU is programmed with a package quantity, the second unit price and quantity modifier are applied during registration following operation of <PRICE SHIFT>.

Example 1

OPERATION			RECEIPT			
Item 1	PLU 1 _{2nd@}	(\$10.00)	PRICE SHIFT 1 PLU The operation declares that the next input is a second unit price. PRICE SHIFT 1 0 PLU SUB TOTAL CA/AMT/TEND	<pre> REG 03-04-2000 13:45 C01 MC#01 000110 1 PLU001 -10.00 1 PLU010 -5.00 TL -15.00 CASH -15.00 </pre>		
	Quantity	1				
	Unit Q'ty	1				
Item 2	PLU 2 _{2nd@}	(\$5.00)				
	Quantity	1				
	Unit Q'ty	1				
Payment	Cash	\$15.00				

Example 2

OPERATION			RECEIPT			
Item	PLU 2 _{2nd@}	(\$10.00)	5 <input checked="" type="checkbox"/> DATE TIME PRICE SHIFT 2 PLU 5 0 00 CA/AMT/TEND	<pre> REG 03-04-2000 13:50 C01 MC#01 000111 5 PLU001 -50.00 TL -50.00 CASH -50.00 CG -0.00 </pre>		
	Quantity	5				
	2nd Q'ty	3				
Payment	Cash	\$50.00				

- The model for the U.S./Canada, use FOR DATE TIME instead of DATE TIME.

Example 3

The procedure shown above are for when the cash register is programmed not to maintain a second unit price shift. It is programmed is performed to maintain a second unit price shift, the following procedure applies.

	OPERATION	RECEIPT
Item 1	PLU 1 _{2nd@} (\$10.00)	<pre> REG 03-04-2000 13:55 C01 MC#01 000112 1 PLU001 -10.00 1 PLU002 -5.00 1 PLU001 -1.00 TL -16.00 CASH -16.00 CG -0.00 </pre>
	Quantity 1	
	Unit Q'ty 1	
Item 2	PLU 2 _{2nd@} (\$5.00)	
	Quantity 1	
	Unit Q'ty 1	
Item 3	PLU 1 (\$1.00)	
	Quantity 1	
	Unit Q'ty 1	
Payment	Cash \$16.00	

Preset tender amount

An amount up to six digits long can be programmed to <CASH> (cash/amount tendered key). Then, when <CASH> is pressed without inputting a value, the programmed value is automatically registered and the transaction is finalized. When an amount is programmed to <CASH>, attempting to manually input an amount results in an error.

Example 1

	OPERATION	RECEIPT
Item	Dept. 1 \$8.00	<pre> REG 03-04-2000 14:00 C01 MC#01 000113 1 DEPT01 -8.00 TL -8.00 CASH -10.00 CG -2.00 </pre>
	Quantity 1	
Payment	Cash (\$10.00)	

Example 2

	OPERATION	RECEIPT
Item	Dept. 1 \$15.00	<pre> REG 03-04-2000 14:05 C01 MC#01 000114 1 DEPT01 -15.00 TL -15.00 CHECK -5.00 CASH -10.00 CG -0.00 </pre>
	Quantity 1	
Payment	Cash (\$10.00)	
	Check \$5.00	

Bottle link operation

You can link PLU or subdepartment to a PLU.

Example

OPERATION			RECEIPT		
Item 1	PLU 1	(\$8.00)	1	PLU	REG 03-04-2000 14:10 C01 MC#01 000115 1 PLU0001 +8.00 1 PLU0011 +0.80 3 PLU0002 +15.00 3 PLU0012 +1.50 TL -25.30 CASH +30.00 CG +4.70
	PLU 11 _{linked}	(\$0.80)	3	%DATE TIME	
	Quantity	1	2	PLU	
Item 2	PLU 2	(\$5.00)	3	0 00 CA/AMT TEND	
	PLU 12 _{linked}	(\$0.50)			
	Quantity	3			
Payment	Cash	\$30.00			

- The model for the U.S./Canada, use FOR DATE TIME instead of DATE TIME.

Bottle returns

Bottle return key

You can use the linked bottle return key to register a bottle return. A PLU whose programmed unit price represents the contents of the bottle, can be linked with PLU whose programmed unit price represents the deposit on the bottle. In the following example, the bottle return key has been programmed to operate as a linked bottle return key.

The bottle return key must be pressed before input of each new linked bottle return.

Example

OPERATION			RECEIPT		
Return Item 1	PLU 1	(\$8.00)	BR	1	REG 03-04-2000 14:15 C01 MC#01 000116 BR 1 PLU0011 -0.80 BR 3 PLU0012 -1.50 TL -2.30 CASH -2.30
	PLU 11 _{linked}	(\$0.80)	3	%DATE TIME	
	Quantity	1	BR	2	
Return Item 2	PLU 2	(\$5.00)		CA/AMT TEND	
	PLU 12 _{linked}	(\$0.50)			
	Quantity	3			
Payment	Cash	\$2.30			

- The model for the U.S./Canada, use FOR DATE TIME instead of DATE TIME.

Arrangement key registrations

Key operations can be assigned to an <ARRANGE> (arrangement key). Then, simply pressing <ARRANGE> performs all of the key functions assigned to it.

Key operations can also be assigned to an address code. Then, when you input the address code using <ARRANGE>, all of the key functions assigned to the address code are performed.

Example 1

OPERATION			RECEIPT																
<table border="1"> <thead> <tr> <th colspan="3">Arrangement 1</th> </tr> </thead> <tbody> <tr> <td rowspan="2">Item 1</td> <td>PLU 1</td> <td>(\$8.00)</td> </tr> <tr> <td>Quantity</td> <td>1</td> </tr> <tr> <td rowspan="2">Item 2</td> <td>PLU 2</td> <td>(\$5.00)</td> </tr> <tr> <td>Quantity</td> <td>1</td> </tr> <tr> <td>Payment</td> <td>Cash</td> <td>\$13.00</td> </tr> </tbody> </table>			Arrangement 1			Item 1	PLU 1	(\$8.00)	Quantity	1	Item 2	PLU 2	(\$5.00)	Quantity	1	Payment	Cash	\$13.00	<div style="border: 1px solid black; padding: 5px; display: inline-block;">ARR</div> <pre> REG 03-04-2000 14:20 C01 MC#01 000117 1 PLU0001 -8.00 1 PLU0002 -5.00 TL -13.00 CASH -13.00 </pre>
Arrangement 1																			
Item 1	PLU 1	(\$8.00)																	
	Quantity	1																	
Item 2	PLU 2	(\$5.00)																	
	Quantity	1																	
Payment	Cash	\$13.00																	

Example 2

OPERATION			RECEIPT																
<table border="1"> <thead> <tr> <th colspan="3">Arrangement 5</th> </tr> </thead> <tbody> <tr> <td rowspan="2">Item 1</td> <td>Dept 1</td> <td>\$1.00</td> </tr> <tr> <td>Quantity</td> <td>1</td> </tr> <tr> <td rowspan="2">Item 2</td> <td>Dept 2</td> <td>\$2.00</td> </tr> <tr> <td>Quantity</td> <td>1</td> </tr> <tr> <td>Payment</td> <td>Cash</td> <td>\$3.00</td> </tr> </tbody> </table>			Arrangement 5			Item 1	Dept 1	\$1.00	Quantity	1	Item 2	Dept 2	\$2.00	Quantity	1	Payment	Cash	\$3.00	<div style="display: inline-block; border: 1px solid black; padding: 2px;">5</div> <div style="display: inline-block; border: 1px solid black; padding: 2px; margin-left: 5px;">ARR</div> <pre> REG 03-04-2000 14:25 C01 MC#01 000118 1 DEPT01 -1.00 1 DEPT02 -2.00 TL -3.00 CASH -3.00 </pre>
Arrangement 5																			
Item 1	Dept 1	\$1.00																	
	Quantity	1																	
Item 2	Dept 2	\$2.00																	
	Quantity	1																	
Payment	Cash	\$3.00																	

Set menu

When you register a set menu, its total amount is added to the PLU totalizer and counter. The price of each set menu item is also added to each respective PLU totalizer and counter.

Example

OPERATION			RECEIPT																		
<table border="1"> <thead> <tr> <th>Set menu</th> <th>PLU 35</th> <th>\$5.00</th> </tr> </thead> <tbody> <tr> <td>Item 1</td> <td>PLU 1</td> <td>--</td> </tr> <tr> <td>Item 2</td> <td>PLU 2</td> <td>--</td> </tr> <tr> <td>Item 3</td> <td>PLU 3</td> <td>--</td> </tr> <tr> <td>Item 4</td> <td>PLU 4</td> <td>--</td> </tr> <tr> <td>Payment</td> <td>Cash</td> <td>\$5.00</td> </tr> </tbody> </table>			Set menu	PLU 35	\$5.00	Item 1	PLU 1	--	Item 2	PLU 2	--	Item 3	PLU 3	--	Item 4	PLU 4	--	Payment	Cash	\$5.00	<div style="display: inline-block; border: 1px solid black; padding: 2px;">3</div> <div style="display: inline-block; border: 1px solid black; padding: 2px; margin-left: 5px;">5</div> <div style="display: inline-block; border: 1px solid black; padding: 2px; margin-left: 5px;">PLU</div> <div style="border: 1px solid black; padding: 2px; margin-left: 5px; font-size: 8px;">CA/AMT /TEND</div> <pre> REG 03-04-2000 14:30 C01 MC#01 000119 1 PLU0035 -5.00 PLU0001 PLU0002 PLU0003 PLU0004 TL -5.00 CASH -5.00 </pre>
Set menu	PLU 35	\$5.00																			
Item 1	PLU 1	--																			
Item 2	PLU 2	--																			
Item 3	PLU 3	--																			
Item 4	PLU 4	--																			
Payment	Cash	\$5.00																			

Currency exchange function

When <CE> (currency exchange key) is pressed, a current subtotal including tax is converted directly into foreign currency and the result is displayed, and the subsequent finalization is handled using the foreign currency. The currency exchange function is released by finalizing a transaction, partial tender operation, receipt issuance, or by pressing <SUBTOTAL>.



Before using the currency exchange function, it is necessary to program the conversion rate.















Registering foreign currency

Full amount tender in foreign currency

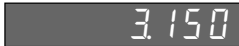
* Pre-programmed exchange rate: ¥ 100 = \$0.9524

Important!

Tenders in a foreign currency can be registered using the  and  only. Other finalize keys cannot be used.







OPERATION	DISPLAY	RECEIPT
<p>1 0 00  ← Enter the unit price and press the applicable department key.</p>	 (Displays in \$)	<div style="border: 1px solid black; padding: 5px;"> <pre> REG 03-04-2000 14:35 C01 MC#01 000120 1 DEPT01 -10.00 2 DEPT02 -20.00 TL -30.00 CE CASH ¥5,000 CASH -47.62 CG -17.62 </pre> </div>
<p>2 0 00  ← Enter the next unit price and press the applicable department key.</p>	 (Displays in \$)	
<p>  ← Press  and  without entering a numeric value. This operation converts the subtotal (including tax) dollar value into yen by applying a pre-programmed exchange rate. The result is shown on the display and printed on the receipt/journal by programming.</p>	 (Displays in ¥: 3,150)	
<p>5 0 00  ← Enter the amount tendered in yen and press . This operation converts the entered yen amount into dollars by applying a pre-programmed exchange rate. The result is shown on the display.</p> <p>(5,000)</p>	 (Displays in \$)	
<p> ← Press to finalize the transaction. Note that you do not need to reenter the dollar amount. The register automatically calculates the change amount due in dollars and shows it on the display, receipts and journal.</p>	 (Displays in \$)	

Partial tender in a foreign currency

* Pre-programmed exchange rate: ¥ 100 = \$0.9524

Important!

Partial tender in a foreign currency can be registered using **CA/AMT/TEND** and **CHK/TEND** only. Other finalization keys cannot be used, but the remaining tender can be finalized using any finalize key.

OPERATION	DISPLAY	RECEIPT
1 0 00 1 ← Enter the unit price and press the applicable department key.	 (Displays in \$)	<pre> REG 03-04-2000 14:40 C01 MC#01 000121 1 DEPT01 -10.00 1 DEPT02 -20.00 TL -30.00 CE CASH ¥2,000 CASH -19.05 CHK -10.95 </pre>
2 0 00 2 ← Enter the next unit price and press the applicable department key.	 (Displays in \$)	
CE SUB TOTAL ← Press CE and SUB TOTAL without entering a numeric value. This operation converts the subtotal (including tax) dollar value into yen by applying a pre-programmed exchange rate. The result is shown on the display and printed on the receipt/journal by programming.	 (Displays in ¥: 3,150)	
2 0 00 CE (2,000) ← Enter the partial amount tendered in yen and press CE . This operation converts the entered yen amount into dollars by applying a pre-programmed exchange rate. The result is shown on the display.	 (Displays in \$)	
CA/AMT/TEND ← Press CA/AMT/TEND to specify cash tender for the yen partial tender. Note that you do not need to reenter the dollar amount. The register automatically deducts the dollar equivalent of the yen amount tendered from the total amount due and shows the amount on the display.	 (Displays in \$)	
CHK/TEND ← Press to finalize the transaction.	 (Displays in \$)	

Food stamp function

Food stamp registration

No change due



OPERATION

RECEIPT

Item 1	Dept. 1	\$1.00
	Taxable	1, F/S
Item 2	Dept. 2	\$2.00
	Taxable	2
Item 3	Dept. 3	\$3.00
	Taxable	No → F/S
Payment	Food stamp	\$2.00
	Cash	\$4.14

1 00 1
2 00 2
F/S 3 00 3
 Shifting food stamp status, press F/S key.
FS/ST
 Press FS/ST, at the top of the food stamp tender.
2 00 FS/ST
CA/AMT/TEND

REG	03-04-2000	14:45
C01	MC#01	000122
1 DEPT01	T1 F	\$1.00
1 DEPT02	T2	\$2.00
1 DEPT03	F	\$3.00
TA1		\$1.00
TX1		\$0.04
TA2		\$2.00
TX2		\$0.10
TL	\$6.14	Subtotal
FSST	\$4.04	Food stamp subtotal
FSTD	\$2.00	Food stamp tendered
CASH	\$4.14	

Mixed food stamp/cash change

Example 1

OPERATION			RECEIPT		
Item 1	Dept. 1	\$1.00	1 00	1	REG 03-04-2000 14:50 C01 MC#01 000123 1 DEPT01 T1 F \$1.00 1 DEPT02 T2 F \$2.00 1 DEPT03 F \$3.00 TA1 \$1.00 TX1 \$0.04 TA2 \$2.00 TX2 \$0.10 TL \$6.14 — Subtotal FSST \$6.14 — Food stamp subtotal FSTD \$7.00 — Food stamp tendered CG \$0.86 — Cash change
	Taxable	1, F/S	F/S 2 00	2	
Item 2	Dept. 2	\$2.00	F/S 3 00	3	
	Taxable	2, F/S		FS/ST	
Item 3	Dept. 3	\$3.00	7 00	FS/ST	
	Taxable	F/S		FS/ST	
Payment	Food stamp	\$7.00			

The change in food stamp transactions is automatically calculated as cash for amounts of \$1.00 or less, and as food stamps for amounts greater than \$1.00.

Example 2

OPERATION			RECEIPT		
Item	Dept. 1	\$2.00	2 00	1	REG 03-04-2000 14:55 C01 MC#01 000124 1 DEPT01 T1 F \$2.00 TA1 \$2.00 TX1 \$0.08 TL \$2.08 FSST \$2.08 FSTD \$5.00 FSCG \$2.00 CG \$0.92
	Taxable	1, F/S		FS/ST	
Payment	Food stamp	\$5.00	5 00	FS/ST	

In the above example, the total amount of change due is \$2.92; \$2.00 in food stamps and \$0.92 in cash.

Advanced Operations

Mixed food stamp/cash change (continued...)

Example 3

OPERATION			RECEIPT	
Item 1	Dept. 1	\$2.00	2 00 1	<pre> REG 03-04-2000 15:00 C01 MC#01 000125 1 DEPT01 T1 F \$1.00 1 DEPT04 \$0.50 TA1 \$2.00 TX1 \$0.08 TL \$2.58 FSST \$2.08 FSTD \$5.00 FSCG \$2.00 CG \$0.42 </pre>
	Taxable	1, F/S	5 0 4	
Item 2	Dept. \$	\$0.50	FS/ST	
	Taxable	No	5 00 FS/TD	
Payment	Food stamp	\$5.00		

When food stamp items are included in a transaction, the amount of change due in cash is applied as a cash amount tendered for cash (nonfood stamp) items. In this example, the \$0.50 purchased (department 4) is automatically deducted from the \$0.92 cash due in change from the food stamp purchase (department 4).

Example 4

OPERATION			RECEIPT	
Item 1	Dept. 1	\$1.00	1 00 1	<pre> REG 03-04-2000 15:05 C01 MC#01 000126 1 DEPT01 T1 F \$1.00 1 DEPT02 T2 \$2.00 1 DEPT03 \$3.00 TA1 \$1.00 TX1 \$0.04 TA2 \$2.00 TX2 \$0.10 TL \$6.14 FSST \$1.04 FSTD \$5.00 FSCG \$3.00 CASH \$4.14 </pre>
	Taxable	1, F/S	2 00 2	
Item 2	Dept. 2	\$2.00	3 00 3	
	Taxable	2	FS/ST	
Item 3	Dept. 3	\$3.00	5 00 FS/TD	
	Taxable	No	CA/AMT/TEND	
Payment	Food stamp	\$5.00		
	Cash	\$4.14		

The following calculation is performed internally to apply the cash change due on the food stamp transaction to the balance due of the cash transaction.

	Food stamp transaction	Cash transaction
Price items:	\$1.00	\$5.00
Tax:	\$0.04	\$0.10
Total due:	\$1.04	\$5.10
Amount tendered:	\$5.00 (food stamp)	\$4.14 (cash), \$0.96 (change from food stamp)
Amount due:	\$1.04	
Change amount due:	\$3.00 (food stamp), \$0.96 (cash)	
Total:		\$5.10

Food stamp registration (Illinois rule)

No change due

Example 1

			OPERATION	RECEIPT
Item 1	Dept. 1	\$1.00	1 00 1	<pre> REG 03-04-2000 15:10 C01 MC#01 000127 1 DEPT01 T1 F \$1.00 1 DEPT01 T1 F \$2.00 DEPT04 F \$3.00 TL \$6.00 FSST \$6.00 FSTD \$6.00 </pre>
	Taxable	1, F/S	2 00 1	
Item 2	Dept. 1	\$2.00	3 00 4	
	Taxable	1, F/S	FS/ST	
Item 3	Dept. 4	\$3.00	6 00 FS/TD	
	Taxable	F/S		
Payment	Food stamp	\$6.00		

Example 2

			OPERATION	RECEIPT
Item 1	Dept. 1	\$2.00	2 00 1	<pre> REG 03-04-2000 15:15 C01 MC#01 000128 1 DEPT01 T1 F \$2.00 1 DEPT01 T1 F \$3.00 1 DEPT04 F \$4.00 FSST \$9.00 FSTD \$5.00 TA1 \$4.00 TX1 \$0.16 CASH \$4.16 </pre>
	Taxable	1, F/S	3 00 1	
Item 2	Dept. 1	\$3.00	4 00 4	
	Taxable	1, F/S	FS/ST	
Item 3	Dept. 4	\$4.00	5 00 FS/TD	
	Taxable	1, F/S		
Payment	Food stamp	\$5.00	CA/AMT/TEND	
	Cash	\$4.16		

Advanced Operations

No change due (continued...)

Example 3

OPERATION			RECEIPT	
Item 1	Dept. 1	\$2.00	2 00 1	REG 03-04-2000 15:20 C01 MC#01 000129 1 DEPT01 T1 F \$2.00 1 DEPT02 T2 F \$3.00 FSST \$5.00 FSTD \$1.00 TA1 \$1.00 TX1 \$0.04 TA2 \$2.00 TX2 \$0.10 CASH \$4.14
	Taxable	1, F/S	3 00 2	
Item 2	Dept. 2	\$3.00	FS/ST	
	Taxable	2, F/S	1 00 FS/TD	
Payment	Food stamp	\$1.00	CA/AMT/TEND	
	Cash	\$4.14		

If the total of the food stamps tendered is less than the food stamp total, the food stamp tendered amount is deducted from the taxable 1 and 2 amount.

Example 4

OPERATION			RECEIPT	
Item 1	Dept. 1	\$1.00	1 00 1	REG 03-04-2000 15:25 C01 MC#01 000130 1 DEPT01 T1 F \$1.00 1 DEPT02 T2 F \$5.00 FSST \$6.00 FSTD \$4.00 TA2 \$1.00 TX2 \$0.05 CASH \$2.05
	Taxable	1, F/S	5 00 2	
Item 2	Dept. 2	\$5.00	FS/ST	
	Taxable	2, F/S	4 00 FS/TD	
Payment	Food stamp	\$4.00	CA/AMT/TEND	
	Cash	\$2.05		

In this case, the result of the taxable 1 amount is "0".

Mixed food stamp/cash change

Example 1

			OPERATION	RECEIPT
Item 1	Dept. 1	\$1.50	1 5 0 1	<pre> REG 03-04-2000 15:30 C01 MC#01 000131 1 DEPT01 T1 F \$1.50 1 DEPT01 T1 F \$2.00 1 DEPT04 F \$3.00 TL \$6.50 FSST \$6.50 FSTD \$10.00 FSCG \$3.00 CG \$0.50 </pre>
	Taxable	1, F/S	2 00 1	
Item 2	Dept. 1	\$2.00	3 00 4	
	Taxable	1, F/S	FS/ST	
Item 3	Dept. 4	\$3.00	1 0 00 FS/ST	
	Taxable	F/S		
Payment	Food stamp	\$10.00		

The change in food stamp transactions is automatically calculated as cash for amount of \$1.00 or less, and as food stamps for amounts greater than \$1.00. In the above example, the total amount of change due is \$3.50 (\$3.00 in food stamps and \$0.50 in cash).

Example 2

			OPERATION	RECEIPT
Item	Dept. 1	\$2.00	2 00 1	<pre> REG 03-04-2000 15:35 C01 MC#01 000132 1 DEPT01 T1 F \$2.00 TL \$2.00 FSST \$2.00 FSTD \$5.00 FSCG \$3.00 </pre>
	Taxable	1, F/S	FS/ST	
Payment	Food stamp	\$5.00	5 00 FS/ST	

Advanced Operations

Mixed food stamp/cash change (continued...)

Example 3

			OPERATION	RECEIPT
Item 1	Dept. 1	\$2.00	2 00 1	REG 03-04-2000 15:40 C01 MC#01 000133 1 DEPT01 T1 F \$2.00 1 DEPT01 T1 F \$1.20 1 DEPT03 T1 \$0.30 TA1 \$0.30 TX1 \$0.01 TL \$3.51 FSST \$3.20 FSTD \$5.00 FSCG \$1.00 CG \$0.49
	Taxable	1, F/S	1 2 0 1	
Item 2	Dept. 1	\$1.20	3 0 3	
	Taxable	1, F/S	FS/ST	
Item 3	Dept. 3	\$0.30	5 00 FS/ST	
	Taxable	1		
Payment	Food stamp	\$5.00		

When food stamp items are included in a transaction, the amount of change due in cash is applied as a cash amount tendered for cash (nonfood stamp) items. In this example, the \$0.30 purchase is automatically deducted from the \$0.80 cash due in change from the food stamp purchase.

Example 4

			OPERATION	RECEIPT
Item 1	Dept. 1	\$1.00	1 00 1	REG 03-04-2000 15:45 C01 MC#01 000134 1 DEPT01 T1 F \$1.00 1 DEPT01 T1 F \$2.50 1 DEPT03 \$5.00 FSST \$3.50 FSTD \$5.00 FSCG \$1.00 CASH \$4.50
	Taxable	1, F/S	2 5 0 1	
Item 2	Dept. 1	\$2.50	5 00 3	
	Taxable	1, F/S	FS/ST	
Item 3	Dept. 3	\$5.00	5 00 FS/ST	
	Taxable	No		
Payment	Food stamp	\$5.00	CA/AMT /TEND	
	Cash	\$4.50		

The following calculation is performed internally to apply the cash change due on the food stamp transaction to the balance due of the cash transaction.

	Food stamp transaction	Cash transaction
Price items:	\$3.50	\$5.00
Tax:	\$0.00	\$0.00
Total due:	\$3.50	\$5.00
Amount tendered:	\$5.00 (food stamp)	\$4.50 (cash), \$0.50 (change from food stamp)
Amount due:	\$3.50	
Change amount due:	\$1.00 (food stamp), \$0.50 (cash)	
Total:		\$5.00

Mixed food stamp/cash change (continued...)

Food stamp + Taxable 1 + Taxable 2

When food stamps are received as partial tender for items preset with the status “food stamp”, “taxable 1”, and “taxable 2”, the calculation are performed using one of the two cases described in this section. The case used depends on the food stamp amount received as partial tender.

Case 1

This case is used when the total amount of the items preset with the status “food stamp”, “taxable 1”, and “taxable 2” is greater than or equal to the food stamp amount received as partial tender. Case 1 subtracts the food stamp amount tendered from both the taxable 1 amount and taxable 2 amount.

Example 5

			OPERATION	RECEIPT
Item 1	Dept. 1	\$2.00	2 00 1	<pre> REG 03-04-2000 15:50 C01 MC#01 000135 1 DEPT01 T1 F \$2.00 1 DEPT02 T2 F \$3.00 1 DEPT01 T12F \$2.00 FSST \$7.00 FSTD \$2.00 TA1 \$2.00 TX1 \$0.08 TA2 \$3.00 TX2 \$0.15 CASH \$5.23 </pre>
	Taxable	1, F/S	3 00 2	
Item 2	Dept. 2	\$3.00	T/S2 2 00 1	
	Taxable	2, F/S	FS/ST	
Item 3	Dept. 1	\$2.00	2 00 FS/ST	
	Taxable	1/2, F/S		
Payment	Food stamp	\$2.00	CA/AMT/TEND	
	Cash	\$5.23		

In this example, the food stamp received as partial tender is \$2.00, so that amount is deducted from both the taxable 1 amount and taxable 2 amount. This means that the remaining taxable 1 amount is \$2.00, while the remaining taxable 2 amount is \$3.00.

Advanced Operations

Mixed food stamp/cash change (continued...)

Case 2

This case is used when the total amount of the items preset with the status “food stamp”, “taxable 1”, and “taxable 2” is less than or equal to the food stamp amount received as partial tender.

Example 6

			OPERATION	RECEIPT
Item 1	Dept. 1	\$2.00	2 00 <input type="text" value="1"/>	<pre> REG 03-04-2000 15:55 C01 MC#01 000136 1 DEPT01 T1 F \$2.00 1 DEPT02 T2 F \$3.00 1 DEPT01 T12F \$2.00 FSST \$7.00 FSTD \$4.00 TAZ \$1.00 TXZ \$0.05 CASH \$3.05 </pre>
	Taxable	1, F/S	3 00 <input type="text" value="2"/>	
Item 2	Dept. 2	\$3.00	<input type="text" value="T/S2"/> 2 00 <input type="text" value="1"/>	
	Taxable	2, F/S	<input type="text" value="FS/ST"/>	
Item 3	Dept. 1	\$2.00	4 00 <input type="text" value="FS/ST"/>	
	Taxable	1/2, F/S		
Payment	Food stamp	\$4.00	<input type="text" value="CA/AMT/TEND"/>	
	Cash	\$3.05		

Electronic benefits transfer

In addition to standard food stamp tender finalizations, this model also allows finalization for tenders electronic benefits transfer (EBT) card.

EBT tenders can be accepted for New Jersey rule or Illinois rule food stamp tenders, as well as for food stamp tenders that do not follow these rules.

About mixed EBT card tenders

When the register is programmed to prohibit an EBT amount tendered that exceeds the food stamp subtotal, nonfood stamp items cannot be paid for using an EBT card. In this case, the following applies:

- $ST - (EBT/TEND - FS/ST) = \text{Balance due}$ (the remaining balance due must be finalized using another finalize key.)

When the register is programmed to allow an EBT amount tendered that exceeds the food stamp subtotal, nonfood stamp items can be paid for using an EBT card. In this case, there are two possible situations:

- $ST > EBT/TEND$
 $ST - (EBT/TEND - FS/ST) = \text{Balance due}$ (the remaining balance due must be finalized using another finalize key.)
- $EBT/TEND > \text{or} = ST$
 $EBT/TEND - ST = \text{cash change}$

No change due

Example 1

OPERATION			RECEIPT	
Item 1	Dept. 1	\$1.00	1 00 1	REG 03-04-2000 16:00 C01 MC#01 000137 1 DEPT01 T1 F \$1.00 1 DEPT02 T2 F \$2.00 1 DEPT03 F \$2.00 TL \$6.00 FSST \$6.00 EBTTD \$6.00
	Taxable	1, F/S	2 00 2	
Item 2	Dept. 2	\$2.00	3 00 3	
	Taxable	2, F/S	FS/ST	
Item 3	Dept. 3	\$3.00	6 00 EBT	
	Taxable	F/S		
Payment	EBT	\$6.00		

Advanced Operations

Example 2

OPERATION			RECEIPT			
Item 1	Dept. 1	\$1.00	1	00	1	REG 03-04-2000 16:05 C01 MC#01 000138 1 DEPT01 T1 F \$1.00 1 DEPT02 T1 F \$2.00 1 DEPT03 T1 \$3.00 FSST \$3.00 EBTTD \$5.00 TA1 \$3.00 TX1 \$0.12 CASH \$1.12
	Taxable	1, F/S	2	00	2	
Item 2	Dept. 2	\$2.00	3	00	3	
	Taxable	1, F/S			FS/ST	
Item 3	Dept. 3	\$3.00	5	00	EBT	
	Taxable	1			CA/AMT TEND	
Payment	EBT	\$5.00				
	Cash	\$1.12				

Change due

OPERATION			RECEIPT			
Item 1	Dept. 1	\$1.00	1	00	1	REG 03-04-2000 16:10 C01 MC#01 000139 1 DEPT01 T1 F \$1.00 1 DEPT02 T1 F \$1.20 1 DEPT03 T1 \$0.30 TA1 \$0.30 TX1 \$0.01 TL \$2.51 FSST \$2.20 EBTTD \$5.00 CG \$2.49
	Taxable	1, F/S	1	2	0	
Item 2	Dept. 2	\$1.20	3	0	3	
	Taxable	1, F/S			FS/ST	
Item 3	Dept. 3	\$0.30	5	00	EBT	
	Taxable	1				
Payment	EBT	\$5.00				

Tips

Example

OPERATION			RECEIPT			
Item 1	Unit price	\$3.00	3	00	1	REG 03-04-2000 16:15 C01 MC#01 000140 1 DEPT01 -3.00 1 DEPT02 -5.00 TIP -0.80 TL \$8.80 CASH \$10.00 CG \$1.20
	Dept.	1	5	00	2	
Item 2	Unit price	\$5.00			SUB TOTAL	
	Dept.	2	8	0	TIP	
Tip	Amount	\$0.80	1	0	00	
Payment	Cash	\$10.00			CA/AMT TEND	

Inputting the number of customers

Example 1

OPERATION			RECEIPT		
Item 1	Unit price	\$15.00	2	CST	REG 03-04-2000 16:20
	Dept.	1	1	5	C01 MC#01 000141
			00	1	
Item 2	Unit price	\$5.00	5	00	CT 2
	Dept.	2			1 DEPT01 -15.00
					1 DEPT02 -5.00
Customer	Number	2			TL -20.00
					CASH -20.00
Payment	Cash	\$20.00			

Example 2

You can only use the following operation to re-input the number of customers when <CUSTOMER> (customer number key) is preset to allow re-input. When programming prohibits re-input of the number of customers, this operation causes an error.

OPERATION			RECEIPT		
			3	CST	REG 03-04-2000 16:25
			1	5	C01 MC#01 000142
			00	1	
			5	00	CT 3
					1 DEPT01 -15.00
			2	CST	1 DEPT02 -5.00
					CT 2
					TL -20.00
			2	0	CASH -20.00
			00		

You can re-input the number of customers either immediately after the initial input or during later registration.

Example 3

You can use the following operation to add customers to an original number of customers input (when addition to the number of the customer is allowed).

OPERATION			RECEIPT		
			3	CST	REG 03-04-2000 16:30
			1	5	C01 MC#01 000143
			00	1	
			5	00	CT 3
					1 DEPT01 -15.00
			2	CST	1 DEPT02 -5.00
					CT 5
					TL -20.00
			2	0	CASH -20.00
			00		

Advanced Operations

Text recall

This procedure is used to recall text by inputting the address where the text is stored. The recalled text is printed on the receipt and journal.

Example

OPERATION			RECEIPT				
Item 1	Unit price	\$46.00	4	6	00	1	REG 03-04-2000 16:35 C01 MC#01 000144 CT 3 1 DEPT01 -46.00 MEDIUM SIZE 1 DEPT02 -10.00 SMALL SIZE TL -56.00 CASH -56.00
	Dept.	1				1	
Item 2	Unit price	\$10.00	1	0	00	2	
	Dept.	2				2	
Payment	Cash	\$56.00					
Text 1	MEDIUM SIZE						
Text 2	SMALL SIZE						

Temporarily releasing compulsion

<OPEN 2> (open 2 key) can be programmed to release specific compulsion.

Example 1

OPERATION			RECEIPT				
Item	Unit price	\$10.00	1	0	00	1	REG 03-04-2000 16:40 C01 MC#01 000145 1 DEPT01 -10.00 TL -10.00 CHECK -10.00
	Dept.	1	1	0	00		
Payment	Check	\$10.00					
Validation compulsory			2	00		2	

Validation compulsory

Validation compulsory is temporarily released.

OPEN 2

Example 2

OPERATION			RECEIPT				
Input customer No. compulsory			1	0	00	1	REG 03-04-2000 16:45 C01 MC#01 000146 1 DEPT01 -10.00 TL -10.00 CHECK -10.00
Item	Unit price	\$10.00					
	Dept.	1					
Payment	Check	\$10.00					

Input customer No. compulsory

Compulsory is temporarily released.

OPEN 2

Printing slip

To perform batch printing on the slip printer, you must first use the memory allocation operation (see program 5 mode in the dealer's manual) to reserve slip buffer memory. The capacity of the slip buffer memory is determined by the number of units of slip buffer memory reserved by the memory allocation operation.

The register can be programmed to check the status of the registration buffer memory whenever slip batch printing is performed, and sound an alarm when the buffer memory is almost full. The alarm sounds when there are 12 lines or less remaining, and once it starts to sound, the only operation you can perform is the cancel operation or operations using one of the following keys.

- <CA/AMT TEND> (cash/amount tendered key) operation
- <CH> (charge key) operation
- <CHK/TEND> (check tendered key) operation
- <DEPOSIT> (deposit key) operation
- <NEW BALANCE> (new balance key) operation
- <SUBTOTAL> (subtotal key) operation

You must perform one of above operations when the registration buffer alarm sounds. Any other operations results in an error.

Printing slips

The cash register can be connected to the optional SP-1300 slip printer, which features an automatic feed function and automatic back feed function.

• Automatic feed function

This function makes it possible to program the number of line feeds that should be inserted from the normal print start position before starting slip printing of a new slip. Even if line feeds are programmed for this function, they are not inserted for validation printing, check endorsement printing, and check printing performed using the slip printer. Note also that line feeds are not inserted automatically at the beginning of a second slip when the transaction requires printing that extends from one slip to another.

• Automatic back feed function

This function performs automatic back feed following slip printing, validation printing, and endorsement printing on the slip printer. The slip paper is released once the back feed operation is complete.

• Manual feed function

<SLIP FEED/RELEASE> (slip feed/release key: assigned to the register's keyboard using the program 4 mode) can be used for manual feed of the slip paper. You perform manual feed by inputting a value for the number of lines (up to two digits in the range of 1 to 99) and then press <SLIP FEED/RELEASE>.

• Manual back feed function

<SLIP BACK FEED/RELEASE> (slip back feed/release key: assigned to the register's keyboard using the program 4 mode) can be used for manual back feed of the slip paper. Manual back feed can be performed by inputting a value for the number of lines (up to two digits in the range of 1 to 99) and then press <SLIP BACK FEED/RELEASE>.

You can print slips using automatic or manual batch printing. The slip print operation can be performed in REG1, REG2, and RF modes only.

Finalizing a registration without inserting a slip paper into the slip printer when the register is programmed as "slip paper insertion into slip printer compulsory before finalizing registration" produces an error.

Advanced Operations

To perform auto batch printing 1

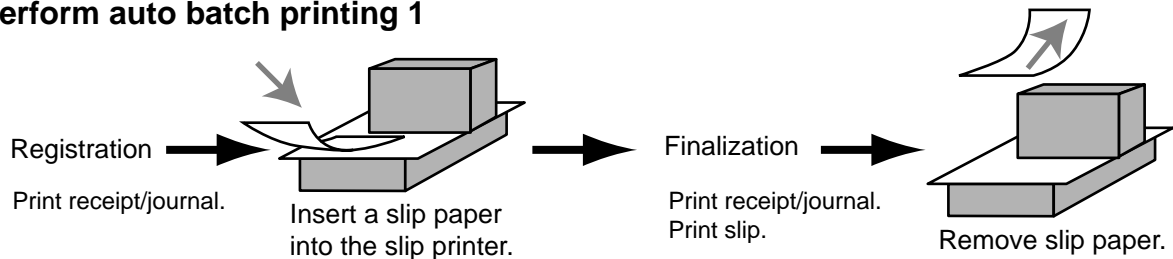

To perform auto batch printing 2

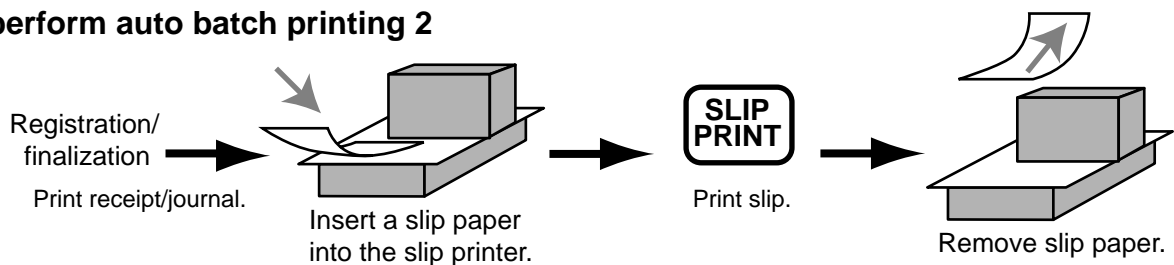

About the maximum number of slip lines

You can program the maximum number of lines that can be printed on a slip. Once you do, any attempt to exceed the preset maximum results in an error. When such an error occurs, press <C>, change slip paper and press <SLIP PRINT> to restart printing.

Check tracking systems

Check tracking system

With the check tracking system, the amount, check number, number of slip print lines, store number, date/time and registration detail data are stored in two files (check tracking index file and check tracking detail file).

- Check tracking detail file and index file are cleared by the following timing:
 1. The check is cleared after printing finalized data on slip or guest check receipts, or the check is also cleared when the new or old check operation is made.
 2. The check is cleared after printing finalized data on slip or guest check receipt, or check is also cleared when the same finalized check number is assigned in new check operation.You can select one of these options by programming.
- Auto new balance function
The register can be programmed so that whenever a clerk (by clerk key) signs off while a check is open, a <NEW BALANCE> operation is automatically performed to temporarily finalize the open check.
- You can specify a range of checks that can be opened by each clerk. Once you do, any attempt by a clerk to open a check using a number that is not within his specified range results in an error.
- Either of the following two operations can be used to correct input of a wrong check number.
 - <NEW CHECK>
Re-input the correct check number, or cancel the original check number, issue a receipt, and then re-input the correct check number.
 - <OLD CHECK>, <NEW/OLD>
Temporary finalize the original check number, issue a receipt, and then re-input the correct check number.

Opening a check

Example

	OPERATION	RECEIPT																					
<table border="1" style="width: 100%; border-collapse: collapse;"> <tr> <td style="width: 15%;">Check#</td> <td colspan="2" style="text-align: right;">1234</td> </tr> <tr> <td>Table#</td> <td colspan="2" style="text-align: right;">33</td> </tr> <tr> <td rowspan="2">Item 1</td> <td>Dept 1</td> <td style="text-align: right;">\$10.00</td> </tr> <tr> <td>Quantity</td> <td style="text-align: right;">2</td> </tr> <tr> <td rowspan="2">Item 2</td> <td>Dept 2</td> <td style="text-align: right;">\$20.00</td> </tr> <tr> <td>Quantity</td> <td style="text-align: right;">2</td> </tr> <tr> <td rowspan="2">Item 3</td> <td>Dept 3</td> <td style="text-align: right;">\$30.00</td> </tr> <tr> <td>Quantity</td> <td style="text-align: right;">1</td> </tr> </table>	Check#	1234		Table#	33		Item 1	Dept 1	\$10.00	Quantity	2	Item 2	Dept 2	\$20.00	Quantity	2	Item 3	Dept 3	\$30.00	Quantity	1	<div style="display: flex; justify-content: space-around; margin-bottom: 5px;"> 1 2 3 4 NEW CHECK </div> <div style="display: flex; justify-content: space-around; margin-bottom: 5px;"> 3 3 TABLE # </div> <div style="display: flex; justify-content: space-around; margin-bottom: 5px;"> 1 0 00 1 </div> <div style="display: flex; justify-content: space-around; margin-bottom: 5px;"> 2 0 00 2 </div> <div style="display: flex; justify-content: space-around; margin-bottom: 5px;"> 3 0 00 3 </div> <p style="text-align: center;">Insert slip</p> <div style="border: 1px solid black; padding: 2px; width: fit-content; margin: 0 auto;">NB</div> <p style="text-align: center;">Remove slip</p>	<pre> REG 03-04-2000 16:50 C01 MC#01 000147 CHECK No. 1234 TBL-# 000033 1 DEPT01 -10.00 1 DEPT01 -10.00 1 DEPT02 -20.00 1 DEPT02 -20.00 1 DEPT03 -30.00 + -0.50 SRVC TL -90.50 </pre>
Check#	1234																						
Table#	33																						
Item 1	Dept 1	\$10.00																					
	Quantity	2																					
Item 2	Dept 2	\$20.00																					
	Quantity	2																					
Item 3	Dept 3	\$30.00																					
	Quantity	1																					

Press <NEW BALANCE> to temporarily close the transaction. If you want to finalize a check immediately, use <CASH>, <CHARGE>, <CREDIT> or <CHECK>.

Adding to a check

Example

	OPERATION	RECEIPT																
<table border="1" style="width: 100%; border-collapse: collapse;"> <tr> <td style="width: 15%;">Check#</td> <td colspan="2" style="text-align: right;">1234</td> </tr> <tr> <td>Table#</td> <td colspan="2" style="text-align: right;">33</td> </tr> <tr> <td rowspan="2">Item 1</td> <td>Dept 1</td> <td style="text-align: right;">\$30.00</td> </tr> <tr> <td>Quantity</td> <td style="text-align: right;">1</td> </tr> <tr> <td rowspan="2">Item 2</td> <td>Dept 2</td> <td style="text-align: right;">\$10.00</td> </tr> <tr> <td>Quantity</td> <td style="text-align: right;">1</td> </tr> </table>	Check#	1234		Table#	33		Item 1	Dept 1	\$30.00	Quantity	1	Item 2	Dept 2	\$10.00	Quantity	1	<div style="display: flex; justify-content: space-around; margin-bottom: 5px;"> 1 2 3 4 OLD CHECK </div> <div style="display: flex; justify-content: space-around; margin-bottom: 5px;"> 3 0 00 1 </div> <div style="display: flex; justify-content: space-around; margin-bottom: 5px;"> 1 0 00 2 </div> <p style="text-align: center;">Insert slip</p> <div style="border: 1px solid black; padding: 2px; width: fit-content; margin: 0 auto;">NB</div> <p style="text-align: center;">Remove slip</p>	<pre> REG 03-04-2000 16:55 C01 MC#01 000148 TABLE No. 000033 CT 1 CHECK No. 1234 ST -90.50 1 DEPT01 -30.00 1 DEPT02 -10.00 + -0.50 SRVC TL -131.00 </pre>
Check#	1234																	
Table#	33																	
Item 1	Dept 1	\$30.00																
	Quantity	1																
Item 2	Dept 2	\$10.00																
	Quantity	1																

- The table number is stored in the check tracking index memory so its input is not required in this operation even if table number input is preset as compulsory. Table number input after inputting the check number may be performed, however, without generating an error.
- Once a check is opened under a number in a certain mode (REG1 or REG2), the same mode must be used to make additions to the check.

Advanced Operations

Issuing a guest receipt

The following operation can be used to print out the balance of a temporarily finalized check.

Example

OPERATION	RECEIPT
1 2 3 4 GUEST RECEIPT Input the number of check you want.	REG 03-04-2000 17:00 C01 MC#01 000149 TABLE No.000033 CT 1 CHECK No. 1234 1 DEPT01 -10.00 1 DEPT01 -10.00 1 DEPT02 -20.00 1 DEPT02 -20.00 1 DEPT03 -30.00 + -0.50 1 DEPT01 -30.00 1 DEPT02 -10.00 + -0.50 SRVC TL -131.00

Closing a check memory

Example

OPERATION	RECEIPT
1 2 3 4 OLD CHECK 1 5 0 00 CA / AMT / TEND	REG 03-04-2000 17:05 C01 MC#01 000150 TABLE No.000033 CT 1 CHECK No.1234 ST -131.00 CASH -150.00 CG -19.00

SLIP

REG	03-04-2000	17:05
C01	MC#01	000150
TABLE No.	000033	CT 1
CHECK No.	1234	
1	DEPT01	+10.00
1	DEPT01	+10.00
1	DEPT02	+20.00
1	DEPT02	+20.00
1	DEPT03	+30.00
	+	+0.50
#13	SRVC TL	-90.50
1	DEPT01	+30.00
1	DEPT02	+10.00
	+	+0.50
#17	SRVC TL	-131.00
	TL	-131.00
	CASH	+150.00
	CG	+19.00

New/old check key operation

Example 1

When a check number is input and <NEW/OLD> is pressed, the key works as a new check key function if there is no matching check number in the check tracking memory.

OPERATION

RECEIPT

3 4 5 6 NEW/OLD
 Input a check number and press
 <NEW/OLD>.
1 0 00 1
2 0 00 2
NB

REG	03-04-2000	17:10
C01	MC#01	000151
CHECK No.	3456	
1	DEPT01	+10.00
1	DEPT02	+20.00
	+	+0.50
	SRVC TL	-30.50

Example 2

When a check number is input and <NEW/OLD> is pressed, the key works as an old check key if there is matching check number in the check tracking memory.

OPERATION

RECEIPT

3 4 5 6 NEW/OLD
3 1 00 CA/AMT TEND

REG	03-04-2000	17:15
C01	MC#01	000152
CHECK No.	3456	CT 1
	ST	+30.50
	TL	-30.50
	CASH	+31.00
	CG	+0.50

Advanced Operations

Add check

This operation lets you combine the amounts of more than one check into a single check.

Example

Registration for check number 1234

	OPERATION	RECEIPT
Original check	<div style="display: flex; justify-content: space-around;"> <div style="display: flex; flex-wrap: wrap;"> <div style="margin: 2px;">1</div><div style="margin: 2px;">2</div><div style="margin: 2px;">3</div><div style="margin: 2px;">4</div><div style="margin: 2px;">NEW CHECK</div> </div> <div style="margin: 2px;">TABLE #</div> </div> <div style="display: flex; justify-content: space-around; margin-top: 5px;"> <div style="display: flex; flex-wrap: wrap;"> <div style="margin: 2px;">3</div><div style="margin: 2px;">3</div> </div> <div style="margin: 2px;">1</div> </div> <div style="display: flex; justify-content: space-around; margin-top: 5px;"> <div style="display: flex; flex-wrap: wrap;"> <div style="margin: 2px;">1</div><div style="margin: 2px;">0</div><div style="margin: 2px;">00</div> </div> <div style="margin: 2px;">1</div> </div> <div style="display: flex; justify-content: space-around; margin-top: 5px;"> <div style="display: flex; flex-wrap: wrap;"> <div style="margin: 2px;">2</div><div style="margin: 2px;">0</div><div style="margin: 2px;">00</div> </div> <div style="margin: 2px;">2</div> </div> <div style="margin: 2px;">NB</div>	

Registration for check number 3456

	OPERATION	RECEIPT								
Added check	<div style="display: flex; justify-content: space-around;"> <div style="display: flex; flex-wrap: wrap;"> <div style="margin: 2px;">3</div><div style="margin: 2px;">4</div><div style="margin: 2px;">5</div><div style="margin: 2px;">6</div><div style="margin: 2px;">NEW CHECK</div> </div> <div style="margin: 2px;">TABLE #</div> </div> <div style="display: flex; justify-content: space-around; margin-top: 5px;"> <div style="display: flex; flex-wrap: wrap;"> <div style="margin: 2px;">3</div><div style="margin: 2px;">0</div><div style="margin: 2px;">00</div> </div> <div style="margin: 2px;">1</div> </div> <div style="margin: 2px;">NB</div>	<div style="border: 1px solid black; padding: 5px; font-family: monospace; font-size: 0.8em;"> REG 03-04-2000 17:25 C01 MC#01 000154 CHECK No. 3456 1 DEPT01 -30.00 + -0.50 SRVC TL -30.50 </div>								
<table border="1" style="width: 100%; border-collapse: collapse;"> <tr> <td style="width: 15%;">Check#</td> <td colspan="2" style="text-align: center;">3456</td> </tr> <tr> <td rowspan="2" style="width: 15%;">Item</td> <td style="width: 15%;">Dept 1</td> <td style="width: 15%;">\$30.00</td> </tr> <tr> <td>Quantity</td> <td style="text-align: center;">1</td> </tr> </table>	Check#	3456		Item	Dept 1	\$30.00	Quantity	1		
Check#	3456									
Item	Dept 1	\$30.00								
	Quantity	1								

Registration for check number 1234

	OPERATION	RECEIPT
<div style="display: flex; justify-content: space-around; align-items: center;"> <div style="border: 1px solid black; padding: 5px; text-align: center;"> Check No. : 1234 </div> <div style="border: 1px dashed black; padding: 5px; text-align: center;"> Check No. : 3456 </div> </div> <div style="margin-top: 20px; text-align: center;"> <div style="display: flex; justify-content: space-around;"> <div style="display: flex; flex-wrap: wrap;"> <div style="margin: 2px;">1</div><div style="margin: 2px;">2</div><div style="margin: 2px;">3</div><div style="margin: 2px;">4</div><div style="margin: 2px;">OLD CHECK</div> </div> <div style="margin: 2px;">ADD CHECK</div> </div> <div style="display: flex; justify-content: space-around; margin-top: 5px;"> <div style="display: flex; flex-wrap: wrap;"> <div style="margin: 2px;">3</div><div style="margin: 2px;">4</div><div style="margin: 2px;">5</div><div style="margin: 2px;">6</div> </div> <div style="margin: 2px;">NB</div> </div> </div>	<div style="border: 1px solid black; padding: 5px; font-family: monospace; font-size: 0.8em;"> REG 03-04-2000 17:30 C01 MC#01 000155 TABLE No.000033 CT 1 CHECK No. 1234 ST -30.50 ADD CHK 3456 ST -30.50 + -0.50 SRVC TL -61.50 </div>	

Separate check

This operation makes it possible to split a single check into separate checks.

Example

Check#		1234
Item 1	Dept 1	\$10.00
	Quantity	1
Item 2	Dept 2	\$20.00
	Quantity	1
Item 3	Dept 3	\$30.00
	Quantity	1
Item 4	Dept 4	\$40.00
	Quantity	1

→

↗

Check#		3456
Item 1	Dept 1	\$10.00
	Quantity	1
Item 2	Dept 3	\$30.00
	Quantity	1
Payment	Cash	\$40.00

OPERATION

RECEIPT

3 4 5 6 NEW CHECK

This input of a temporary check number can be skipped.

1 2 3 4 SEPARATE CHECK

Input the original check number by <SEP CHK>.

Display shows the 1st item which will be separated.

SEPARATE CHECK

After <SEP CHK>, this item is separated.

REVIEW

Display shows the 3rd item which will be separated.

SEPARATE CHECK

NB

4 0 00 CA/AMT TEND

```

REG 03-04-2000 17:35
C01 MC#01 000156
CHECK No.3456

SEP CHK          1234
1 DEPT01         -10.00
1 DEPT03         -30.00
ST              -40.00
CASH             -40.00
CG               -0.00
    
```

Advanced Operations

Clerk transfer

This operation lets you change the clerk who is in charge of a specific open check number.

Example

To change the clerk for check number 1234 from clerk 1 to clerk number 4.

OPERATION	RECEIPT
<p>Press this key if you do not want the clerk No. or clerk secret No. to appear on the display.</p> <p>1 CLK TRANS</p> <p>Input the clerk No. of the clerk who is currently in charge of check No. 1234 (target check).</p> <p>4 OPE #</p> <p>Input the clerk No. of the clerk who will take over check No. 1234 (target check).</p> <p>1 2 3 4 NEW CHECK</p> <p>Input the target check No. that is transferred from clerk 1 to 4. You can use either <OLD CHK>, <NEW/OLD>. Note that if you skip this step, all check Nos currently assigned to clerk 1 are transferred to clerk 4.</p> <p>CLK TRANS</p>	<pre> REG 03-04-2000 17:40 C01 MC#01 000157 CLK TRANS C01 C04 1234 -60.50 ----- TL -60.50 </pre> <p>Check No./NB amount</p>

Table transfer

With this operation, you can change the number of a check.

Example 1

To change the check number 1234 to 1111 (which is newly opened).

Check No: 1234

1111 <CHK TRN>

Check No: 1234

Check No: 1111

OPERATION	RECEIPT
<p>1 2 3 4 NEW CHECK</p> <p>1 0 00 1</p> <p>1 1 1 1 CHECK TRANS</p> <p>Input the new check No.</p>	<pre> REG 03-04-2000 17:45 C01 MC#01 000158 CHECK No. 1234 1 DEPT01 -10.00 ST -10.00 TBL TRANS 1111 SRVC TL -10.00 </pre>

Example 2

To change the check number 3456 to 2222 (which has already been opened).

Check No: 3456

1111 <CHK TRN>

Check No: 3456

Check No: 2222

Added

OPERATION	RECEIPT
<p>3 4 5 6 OLD CHECK</p> <p>1 0 00 1</p> <p>2 2 2 2 CHECK TRANS</p>	<pre> REG 03-04-2000 17:50 C01 MC#01 000159 CHECK No. 3456 ST -10.00 1 DEPT01 -10.00 TBL TRANS 2222 SRVC TL -30.00 </pre>

Price reductions (red price)

You can use the reduced price function to change a price; generally to an amount that is less than the normal price. You can program the register so that it prints the normal price, and the difference between the two prices on the receipt, while on journal, these items are always printed.

The following functions are able to work with red price.

- Department and PLU
- Quantity extension (Preset price is required for both department and PLU.)
- Amount limitation of item program (It effects to new price.)

Note that you cannot use red price with the following types of item.

- Department and PLUs programmed with negative unit prices
- Set menus and link PLUs
- Second unit prices
- Multiplication operations that use the format: Amount × Quantity

Example 1

Item	Dept 1	\$6.00
	Red price	\$4.00
Payment	Cash	\$4.00

OPERATION

4 00 RED PRICE

Input a reduced price.

6 00 1

CA/AMT /TEND

RECEIPT

REG 03-04-2000 17:55
C01 MC#01 000160

RED	-6.00	Old price
RED PRC	-2.00	Reduced price
1 DEPT01	*4.00	New price (Difference between two prices)
TL	-4.00	
CASH	-4.00	

Example 2

Item	PLU 1	\$4.00
	Red price	\$2.00
Payment	Cash	\$6.00

OPERATION

3 DATE TIME

2 00 RED PRICE

Input a reduced price.

1 PLU

CA/AMT /TEND

RECEIPT

REG 03-04-2000 18:00
C01 MC#01 000161

RED	-6.00
RED PRC	-4.00
3 PLU0001	*6.00
TL	-6.00
CASH	-6.00

- The model for the U.S./Canada, use FOR DATE TIME instead of DATE TIME.

Condiment/preparation PLUs

You can force entering condiment or preparation PLU after the main PLU registration by programming.

Example (condiment PLU)

			OPERATION	RECEIPT
Main item	PLU 1	\$10.00	<p>1 PLU</p> <p>Registering main PLU. No condiment registration occurs an error condition.</p> <p>1 1 PLU</p> <p>1 2 PLU</p> <p>1 3 PLU</p> <p>CA/AMT /TEND</p>	<pre>REG 03-04-2000 18:05 C01 MC#01 000162 1 PLU0001 +10.00 PLU0011 +0.10 PLU0012 +0.20 PLU0013 +0.30 TL -10.60 CASH +10.60</pre>
	PLU 11	\$0.10		
Condiment	PLU 12	\$0.20		
	PLU 13	\$0.30		
Payment	Cash	\$10.60		

Example (preparation PLU)

			OPERATION	RECEIPT
Main item	PLU 20	\$20.00	<p>2 0 PLU</p> <p>Registering main PLU.</p> <p>2 1 PLU</p> <p>2 2 PLU</p> <p>2 3 PLU</p> <p>CA/AMT /TEND</p>	<pre>REG 03-04-2000 18:10 C01 MC#01 000163 1 PLU0020 +20.00 PLU0021 PLU0022 PLU0023 TL -20.00 CASH +20.00</pre>
	PLU 21	\$0.00		
Preparation	PLU 22	\$0.00		
	PLU 23	\$0.00		
Payment	Cash	\$20.00		

VAT breakdown printing

You can force printing of the VAT breakdown at the finalize stage, regardless of whether the cash register is programmed to print or skip printing of the VAT breakdown. Every time you want to have VAT breakdown, press <VAT>.

Example

OPERATION			RECEIPT			
Item 1	Dept 1	\$1.00	1 00 1	<pre> REG 03-04-2000 18:15 C01 MC#01 000164 1 DEPT01 T1 -1.00 1 PLU0001 T2 -2.00 TA1 -0.90 TX1 -0.10 TA2 -1.90 TX2 -0.10 TL -3.00 CASH -3.00 </pre>		
	Taxable	1				
Item 2	PLU 1	(\$2.00)	2 PLU			
	Taxable	2	VAT			
Payment	Cash	\$3.00	CA/AMT /TEND			

Deposit registrations

Use the following procedures to register deposits.

Deposit from customer

OPERATION			RECEIPT			
Deposit	Cash	\$50.00	5 0 00	<pre> REG 03-04-2000 18:20 C01 MC#01 000165 DEPO- -50.00 TL -50.00 CASH -50.00 </pre>		
			DEPOSIT -			
			CA/AMT /TEND			

Deposit from customer during sales transaction

OPERATION			RECEIPT			
Items	Dept 1	\$10.00	1 0 00 1	<pre> REG 03-04-2000 18:25 C01 MC#01 000166 1 DEPT01 -10.00 1 DEPT02 -20.00 DEPO+ -20.00 TL -10.00 CASH -10.00 </pre>		
	Dept 2	\$20.00				
Deposit		\$20.00	2 0 00			
			DEPOSIT +			
Payment	Cash	\$10.00	CA/AMT /TEND			

Bill copy

Example 1

To issue a copy of a bill dated February 1, 2000 in the amount of \$35.00 cash.

OPERATION	RECEIPT
<div style="display: flex; justify-content: space-around; align-items: center;"> <div style="display: flex; gap: 5px;"> <div style="border: 1px solid black; padding: 2px 5px;">0</div> <div style="border: 1px solid black; padding: 2px 5px;">2</div> <div style="border: 1px solid black; padding: 2px 5px;">0</div> <div style="border: 1px solid black; padding: 2px 5px;">1</div> <div style="border: 1px solid black; padding: 2px 5px;">2</div> <div style="border: 1px solid black; padding: 2px 5px;">0</div> <div style="border: 1px solid black; padding: 2px 5px;">0</div> <div style="border: 1px solid black; padding: 2px 5px;">0</div> </div> <div style="border: 1px solid black; padding: 2px 5px; font-size: 8px;">BILL COPY</div> </div> <p style="text-align: center; font-size: 10px;">Enter date by date order.</p> <div style="display: flex; justify-content: space-around; align-items: center; margin-top: 10px;"> <div style="display: flex; gap: 5px;"> <div style="border: 1px solid black; padding: 2px 5px;">3</div> <div style="border: 1px solid black; padding: 2px 5px;">5</div> <div style="border: 1px solid black; padding: 2px 5px;">00</div> </div> <div style="border: 1px solid black; padding: 2px 5px; font-size: 8px;">CA/AMT TEND</div> </div>	<pre style="font-family: monospace; font-size: 10px;"> * BILL TOP MESSAGE 1 * * BILL TOP MESSAGE 2 * * BILL TOP MESSAGE 3 * * BILL TOP MESSAGE 4 * REG 02-01-2000 C01 MC#01 * BILL COPY MESSAGE 1 * * BILL COPY MESSAGE 2 * * BILL COPY MESSAGE 3 * * BILL COPY MESSAGE 4 * TA1 -35.00 TX1 -3.50 TL -38.50 CASH -38.50 * BILL BTM MESSAGE 1 * * BILL BTM MESSAGE 2 * * BILL BTM MESSAGE 3 * * BILL BTM MESSAGE 4 *</pre> <div style="font-size: 8px; margin-top: 10px;"> <p>*¹ Programmable option</p> </div>

Note that you can finalize this operation using the cash amount tendered key.

Example 2

To issue a copy of a bill dated February 1, 2000 in the amount of Euro 30.00 cash (sub-currency).

OPERATION	RECEIPT
<div style="display: flex; justify-content: space-around; align-items: center;"> <div style="display: flex; gap: 5px;"> <div style="border: 1px solid black; padding: 2px 5px;">0</div> <div style="border: 1px solid black; padding: 2px 5px;">2</div> <div style="border: 1px solid black; padding: 2px 5px;">0</div> <div style="border: 1px solid black; padding: 2px 5px;">1</div> <div style="border: 1px solid black; padding: 2px 5px;">2</div> <div style="border: 1px solid black; padding: 2px 5px;">0</div> <div style="border: 1px solid black; padding: 2px 5px;">0</div> <div style="border: 1px solid black; padding: 2px 5px;">0</div> </div> <div style="border: 1px solid black; padding: 2px 5px; font-size: 8px;">BILL COPY</div> </div> <div style="display: flex; justify-content: space-around; align-items: center; margin-top: 5px;"> <div style="border: 1px solid black; padding: 2px 5px; font-size: 8px;">EURO PD</div> </div> <div style="display: flex; justify-content: space-around; align-items: center; margin-top: 10px;"> <div style="display: flex; gap: 5px;"> <div style="border: 1px solid black; padding: 2px 5px;">3</div> <div style="border: 1px solid black; padding: 2px 5px;">0</div> <div style="border: 1px solid black; padding: 2px 5px;">00</div> </div> <div style="border: 1px solid black; padding: 2px 5px; font-size: 8px;">CA/AMT TEND</div> </div>	<pre style="font-family: monospace; font-size: 10px;"> * BILL TOP MESSAGE 1 * * BILL TOP MESSAGE 2 * * BILL TOP MESSAGE 3 * * BILL TOP MESSAGE 4 * REG 02-01-2000 C01 MC#01 * BILL COPY MESSAGE 1 * * BILL COPY MESSAGE 2 * * BILL COPY MESSAGE 3 * * BILL COPY MESSAGE 4 * TA1 €27.28 TX1 €2.72 TL €30.00 CASH €30.00 * BILL BTM MESSAGE 1 * * BILL BTM MESSAGE 2 * * BILL BTM MESSAGE 3 * * BILL BTM MESSAGE 4 *</pre> <div style="font-size: 8px; margin-top: 10px;"> <p>*¹ Programmable option</p> </div>

Actual stock quantity inquiry

With this operation, you can recall the actual stock quantity for PLUs and show it on the display of the cash register.

Example

To check the actual stock quantity of PLU 32 and flat-PLU 001.

OPERATION	DISPLAY (7segment)
<div style="display: flex; flex-direction: column; align-items: center;"> <div style="display: flex; gap: 10px;"> <div style="border: 1px solid black; padding: 2px 5px;">3</div> <div style="border: 1px solid black; padding: 2px 5px;">2</div> <div style="border: 1px solid black; padding: 2px 5px;">PLU</div> </div> <div style="margin-top: 5px;"> <div style="border: 1px solid black; padding: 2px 5px;">STOCK INQ</div> <div style="border: 1px solid black; padding: 2px 5px;">001</div> </div> </div>	<div style="border: 1px solid black; padding: 5px; text-align: center; margin-bottom: 10px;">12345</div> <div style="border: 1px solid black; padding: 5px; text-align: center;">1</div> <p style="text-align: center; margin-top: 5px;">Actual stock quantity are appeared.</p>

Unit price inquiry

Use this operation to recall the unit prices of departments, PLUs, second unit price of PLUs, or scanning PLUs. The unit prices appear on the display of the cash register when recalled.

Example

To check the unit price of PLU 32, flat-PLU 001, department 1.

OPERATION	DISPLAY (7 segment)
<div style="display: flex; flex-direction: column; align-items: center;"> <div style="display: flex; gap: 10px;"> <div style="border: 1px solid black; padding: 2px 5px;">3</div> <div style="border: 1px solid black; padding: 2px 5px;">2</div> <div style="border: 1px solid black; padding: 2px 5px;">PLU</div> </div> <div style="margin-top: 5px;"> <div style="border: 1px solid black; padding: 2px 5px;">PRICE INQ</div> </div> </div>	<div style="border: 1px solid black; padding: 5px; text-align: center; margin-bottom: 10px;">145</div>
<div style="display: flex; flex-direction: column; align-items: center;"> <div style="margin-top: 5px;"> <div style="border: 1px solid black; padding: 2px 5px;">PRICE INQ</div> <div style="border: 1px solid black; padding: 2px 5px;">001</div> </div> </div>	<div style="border: 1px solid black; padding: 5px; text-align: center; margin-bottom: 10px;">300</div>
<div style="display: flex; flex-direction: column; align-items: center;"> <div style="margin-top: 5px;"> <div style="border: 1px solid black; padding: 2px 5px;">PRICE INQ</div> <div style="border: 1px solid black; padding: 2px 5px;">1</div> </div> </div>	<div style="border: 1px solid black; padding: 5px; text-align: center;">1400</div>

Previous item void using <REVIEW>

You can correct the previously registered item(s) in the same transaction by using <REVIEW> (review key).

Example

	OPERATION	DISPLAY
Item 1	Dept. 1 \$2.35	1 ST ·2.35 DEPT01
	Quantity 1	2.35
Item 2	Dept. 2 \$2.00	2 ST ·4.35 DEPT02
	Quantity 1	2.00
Item 3	PLU 1 (\$1.20) _{preset}	3 ST ·5.55 PLU001
	Quantity 1	1.20
Corrected Item 1	Dept. 1 \$2.35	** REVIEW ** DEPT01 1 QT
	Quantity 1	2.35
Payment	Cash \$3.20	2 ST ·3.20 DEPT01
		-2.35
		CASH
		3.20

Review the item to be corrected.

Press <VOID> to correct.

RECEIPT

```

REG 03-04-2000 18:40
C01    MC#01    000169

1 DEPT01            ·2.35
1 DEPT02            ·2.00
1 PLU0001            ·1.20
VOID                .....
1 DEPT01            -2.35
TL                   -3.20
CASH                ·3.20
    
```

Scanning PLU

Product barcodes are read by scanning with hand-held scanner, and are filed in the scanning PLU file together with the unit price, item descriptor, programming status, link department, totalizer and counter.

When a barcode is entered by scanning, or from the keyboard by using <OBR> (OBR key) or <One touch NLU> (One touch NLU key) and it has been filed in the scanning PLU file, the preset unit price is accumulated to its own totalizer and other appropriate totalizers.

Scanning PLUs include UPC-A/UPC-E/EAN-13/EAN-8, source marking, in-store marking code.

Item registration

By scanner/code input/one touch NLU key

	OPERATION	RECEIPT																		
<table border="1" style="width: 100%; border-collapse: collapse;"> <tr> <td rowspan="2">Item 1 (scan)</td> <td>Scan-PLU</td> <td>(\$2.35)</td> </tr> <tr> <td>PLU code</td> <td>49012347</td> </tr> <tr> <td rowspan="2">Item 2 (code)</td> <td>Scan-PLU</td> <td>(\$2.00)</td> </tr> <tr> <td>PLU code</td> <td>123456</td> </tr> <tr> <td rowspan="2">Item 3 (OTN)</td> <td>Scan-PLU</td> <td>(\$1.23)</td> </tr> <tr> <td>PLU code</td> <td>49012354</td> </tr> <tr> <td>Payment</td> <td>Cash</td> <td>\$5.58</td> </tr> </table>	Item 1 (scan)	Scan-PLU	(\$2.35)	PLU code	49012347	Item 2 (code)	Scan-PLU	(\$2.00)	PLU code	123456	Item 3 (OTN)	Scan-PLU	(\$1.23)	PLU code	49012354	Payment	Cash	\$5.58	<p>“Scanning”</p> <div style="display: flex; justify-content: center; gap: 10px;"> <div style="border: 1px solid black; padding: 2px 5px;">1</div> <div style="border: 1px solid black; padding: 2px 5px;">2</div> <div style="border: 1px solid black; padding: 2px 5px;">3</div> </div> <div style="display: flex; justify-content: center; gap: 10px; margin-top: 5px;"> <div style="border: 1px solid black; padding: 2px 5px;">4</div> <div style="border: 1px solid black; padding: 2px 5px;">5</div> <div style="border: 1px solid black; padding: 2px 5px;">6</div> <div style="border: 1px solid black; padding: 2px 5px;">OBR</div> </div> <p style="font-size: small;">Scanning-PLU code and OBR key</p> <div style="display: flex; justify-content: center; margin-top: 20px;"> <div style="border: 1px solid black; padding: 2px 5px;">NLU</div> </div> <p style="font-size: small;">One touch NLU</p> <div style="display: flex; justify-content: center; margin-top: 20px;"> <div style="border: 1px solid black; padding: 2px 5px; font-size: x-small;">CA/AMT /TEND</div> </div>	<pre style="font-family: monospace; font-size: small;"> REG 03-04-2000 18:45 C01 MC#01 000170 1 Scan-PLU01 -2.34 #49012347 1 Scan-PLU02 -2.00 #123456 1 Scan-PLU03 -1.23 #49012354 TL -5.58 CASH -5.58 </pre> <p style="font-size: x-small;">*1 Scanning PLU code *1</p> <p style="font-size: x-small;">*1 Programmable option</p>
Item 1 (scan)		Scan-PLU	(\$2.35)																	
	PLU code	49012347																		
Item 2 (code)	Scan-PLU	(\$2.00)																		
	PLU code	123456																		
Item 3 (OTN)	Scan-PLU	(\$1.23)																		
	PLU code	49012354																		
Payment	Cash	\$5.58																		

Not found PLU

When a scanning PLU item which does not exist in the scanning PLU file is registered, an error occurs (Item not found error). In this case, you can input this item to the ECR and register it at the same time. After this operation, “Item not found error” does not occur during the next registration.

	OPERATION	RECEIPT															
<table border="1" style="width: 100%; border-collapse: collapse;"> <tr> <td rowspan="3">Item 1 (scan)</td> <td>Scan-PLU</td> <td>(\$1.00)</td> </tr> <tr> <td>PLU code</td> <td>49012361</td> </tr> <tr> <td>Dept.</td> <td>1</td> </tr> <tr> <td rowspan="2">Item 2 (scan)</td> <td>Scan-PLU</td> <td>(\$1.00)</td> </tr> <tr> <td>PLU code</td> <td>49012361</td> </tr> <tr> <td>Payment</td> <td>Cash</td> <td>\$2.00</td> </tr> </table>	Item 1 (scan)	Scan-PLU	(\$1.00)	PLU code	49012361	Dept.	1	Item 2 (scan)	Scan-PLU	(\$1.00)	PLU code	49012361	Payment	Cash	\$2.00	<p>“Scanning”</p> <p style="font-size: x-small;">Does not exist in the scanning PLU file</p> <p>“Not Found Error”</p> <div style="display: flex; justify-content: center; gap: 10px; margin-top: 5px;"> <div style="border: 1px solid black; padding: 2px 5px;">1</div> <div style="border: 1px solid black; padding: 2px 5px;">0</div> <div style="border: 1px solid black; padding: 2px 5px;">0</div> <div style="border: 1px solid black; padding: 2px 5px;">1</div> </div> <p style="font-size: x-small;">Input price and press the linked department key.</p> <p>“Scanning”</p> <p style="font-size: x-small;">Register normally.</p> <div style="display: flex; justify-content: center; margin-top: 20px;"> <div style="border: 1px solid black; padding: 2px 5px; font-size: x-small;">CA/AMT /TEND</div> </div>	<pre style="font-family: monospace; font-size: small;"> REG 03-04-2000 18:50 C01 MC#01 000171 1 DEPT01 -1.00 #49012361 1 DEPT01 -1.00 #49012361 TL -2.00 CASH -2.00 </pre> <p style="font-size: x-small;">Link department descriptor/amount</p>
Item 1 (scan)		Scan-PLU	(\$1.00)														
		PLU code	49012361														
	Dept.	1															
Item 2 (scan)	Scan-PLU	(\$1.00)															
	PLU code	49012361															
Payment	Cash	\$2.00															

After daily operation, a “Not found PLU maintenance” is necessary to merge not found PLU(s) into the scanning PLU file. Please consult with your dealer in detail.

Programming to clerk

You can program up to 4-digit assigning number (clerk number), trainee status of clerk (i.e. training cashier) and commission rate for each clerk.

Programming clerk number

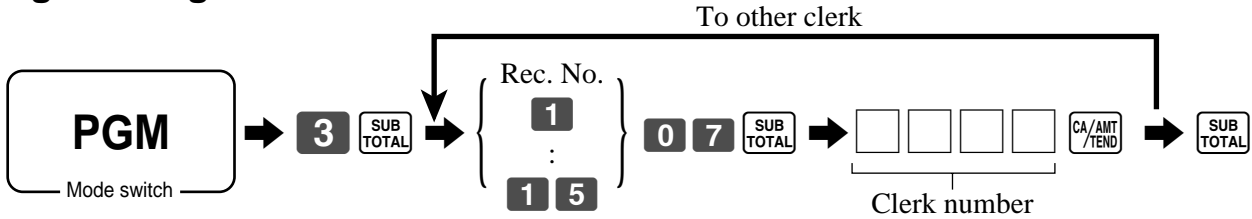

Programming trainee status

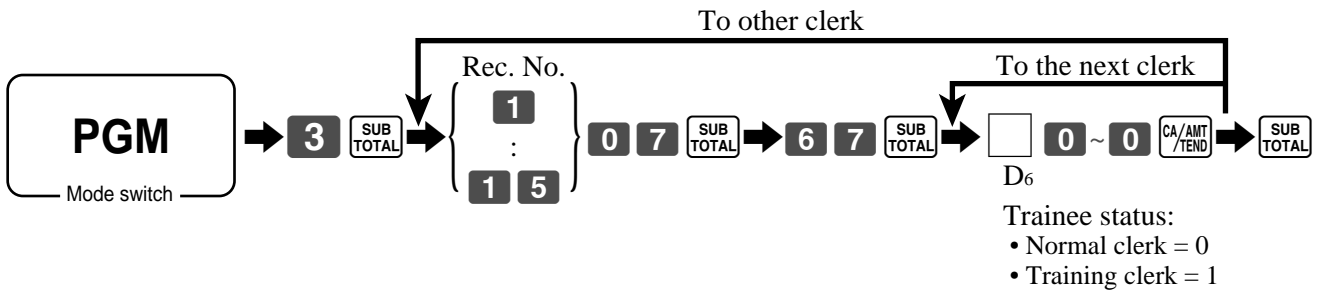

Programming commission rate

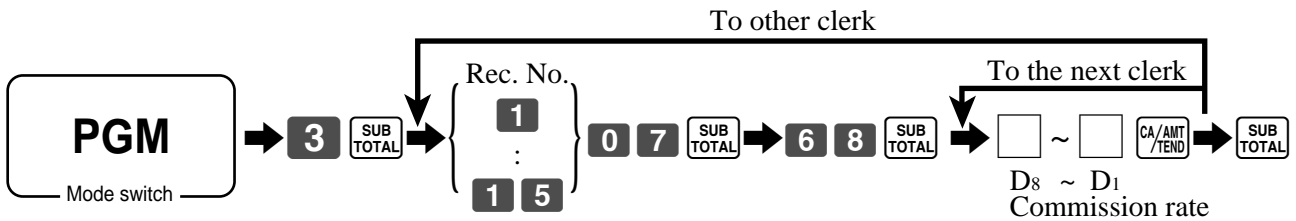

Record No.	Clerk number				Trainee status		Commission rate							
							Commission rate 1				Commission rate 2			
							Integer		Decimal		Integer		Decimal	
D4	D3	D2	D1	D6	00000	D8	D7	D6	D5	D4	D3	D2	D1	
1						00000								
2						00000								
3						00000								
4						00000								
5						00000								
6						00000								
7						00000								
8						00000								
14						00000								
15						00000								

Character programming can be performed in two ways:

- Character keyboard programming (see page 99),
or
- Entering characters by code (see page 100).

Programming descriptors and messages

The following descriptors and messages can be programmed;

- Messages (Logo, commercial and bottom message)
- Clerk name
- PLU item descriptor
- Department key descriptor
- Machine number

Programming receipt message and clerk name

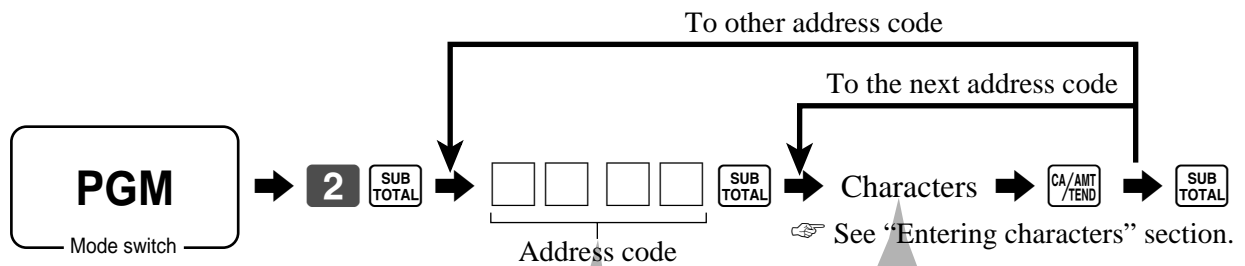

Address code	Contents	Initial character	Yours																				
0107	Clerk 01	C01																					
0207	Clerk 02	C02																					
0307	Clerk 03	C03																					
0407	Clerk 04	C04																					
0507	Clerk 05	C05																					
0607	Clerk 06	C06																					
0707	Clerk 07	C07																					
0807	Clerk 08	C08																					
1407	Clerk 14	C14																					
1507	Clerk 15	C15																					

Machine number

Up to 8 characters can be set.

Address code	Contents	Initial character
Machine number		
0191	Machine number	MC#01

Advanced Operations

Address code	Contents	Initial character	Yours
0132	1st line of logo message	YOUR RECEIPT THANK YOU CALL AGAIN	
0232	2nd line of logo message		
0332	3rd line of logo message		
0432	4th line of logo message		
0532	1st line of commercial message		
0632	2nd line of commercial message		
0732	3rd line of commercial message		
0832	4th line of commercial message		
0932	1st line of bottom message		
1032	2nd line of bottom message		
1132	3rd line of bottom message		
1232	4th line of bottom message		
1332	1st line of bill top message		
1432	2nd line of bill top message		
1532	3rd line of bill top message		
1632	4th line of bill top message		
1732	1st line of bill copy message		
1832	2nd line of bill copy message		
1932	3rd line of bill copy message		
2032	4th line of bill copy message		
2132	1st line of bill bottom message		
2232	2nd line of bill bottom message		
2332	3rd line of bill bottom message		
2432	4th line of bill bottom message		
2532	Post receipt message		
2632	1st line of guest intermediate msg.		
2732	2nd line of guest intermediate msg.		
2832	3rd line of guest intermediate msg.		
2932	4th line of guest intermediate msg.		
3032	1st line of guest bottom msg.		
3132	2nd line of guest bottom msg.		
3232	3rd line of guest bottom msg.		
3332	4th line of guest bottom msg.		
3432	5th line of guest bottom msg.		
3532	6th line of guest bottom msg.		
3632	7th line of guest bottom msg.		
3732	8th line of guest bottom msg.		
3832	9th line of guest bottom msg.		
3932	10th line of guest bottom msg.		

Programming department/transaction key descriptor

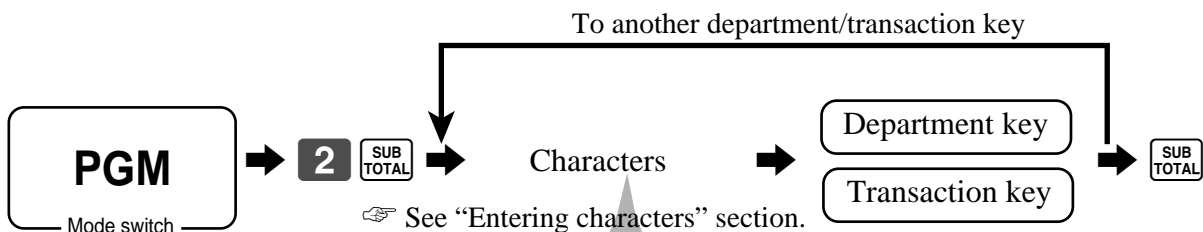

Contents	Initial character	Yours									
Department 01	DEPT01										
Department 02	DEPT02										
Department 03	DEPT03										
Department 04	DEPT04										
Department 05	DEPT05										
Department 06	DEPT06										

Contents	Initial character	Yours									
Cash/Amount tendered	CASH										
Charge	CHARGE										
Check	CHECK										
Credit 1	CREDIT1										
Credit 2	CREDIT2										
Loan	LOAN										
Received on account	RC										
Paid out	PD										
Pick up	P.UP										
Minus	-										
Discount	%-										
Refund	RF										
Correction	CORR										
Validation	VLD										
Receipt	RCT										
Non add/No sale	#/NS										
VAT	VAT										
Tax shift 1	T/51										
Tax shift 2	T/52										
Open	OPEN										
Clerk number	CLK#										
Subtotal	SUBTOTAL										
Receipt on/off	RCT ON/OFF										
Multiplication/Date time	X										
Multiplication/for/Date time	QT										
Two zero	00										
Decimal point	.										
Media change	MEDIA CHG										

Advanced Operations

Programming flat-PLU descriptor

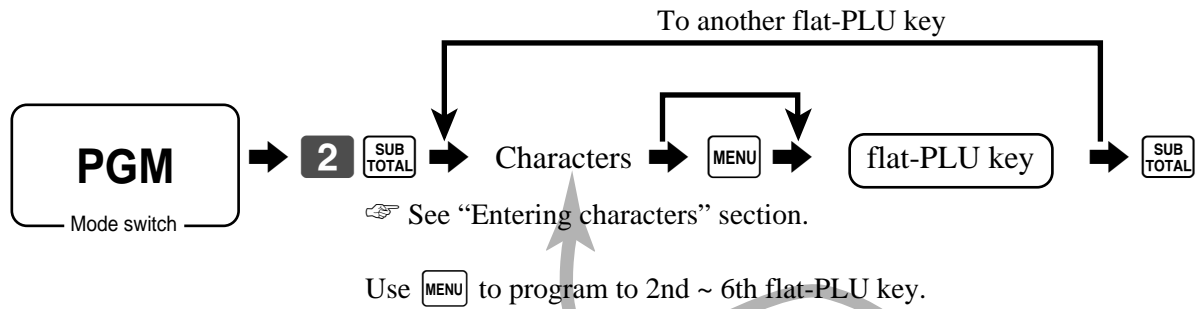

PLU No.	Contents	Initial character	Yours									
PLU												
001	PLU 001	PLU0001										
002	PLU 002	PLU0002										
003	PLU 003	PLU0003										
004	PLU 004	PLU0004										
005	PLU 005	PLU0005										
006	PLU 006	PLU0006										
007	PLU 007	PLU0007										
008	PLU 008	PLU0008										
009	PLU 009	PLU0009										
010	PLU 010	PLU0010										
011	PLU 011	PLU0011										
012	PLU 012	PLU0012										
013	PLU 013	PLU0013										
014	PLU 014	PLU0014										
015	PLU 015	PLU0015										
016	PLU 016	PLU0016										
017	PLU 017	PLU0017										
018	PLU 018	PLU0018										
019	PLU 019	PLU0019										
020	PLU 020	PLU0020										
021	PLU 021	PLU0021										
022	PLU 022	PLU0022										
023	PLU 023	PLU0023										
024	PLU 024	PLU0024										
025	PLU 025	PLU0025										
026	PLU 026	PLU0026										
027	PLU 027	PLU0027										
028	PLU 028	PLU0028										
029	PLU 029	PLU0029										
030	PLU 030	PLU0030										
031	PLU 031	PLU0031										

Entering characters

In this section, the method to enter descriptors or messages (characters) to the cash register during programming is described.

Characters are specified by character keyboard or by codes. In the first half of this section, the usage of character keyboard is described. In the latter half, inputting method by character code is described.

Using character keyboard

Example:

Input “ **A** p p l e J u i c e ”,
 enter “DBL” “A” “SHIFT” “p” “p” “l” “e” “SPACE” “CAP” “J” “SHIFT” “u” “i” “c” “e” **00** .

TK-7000

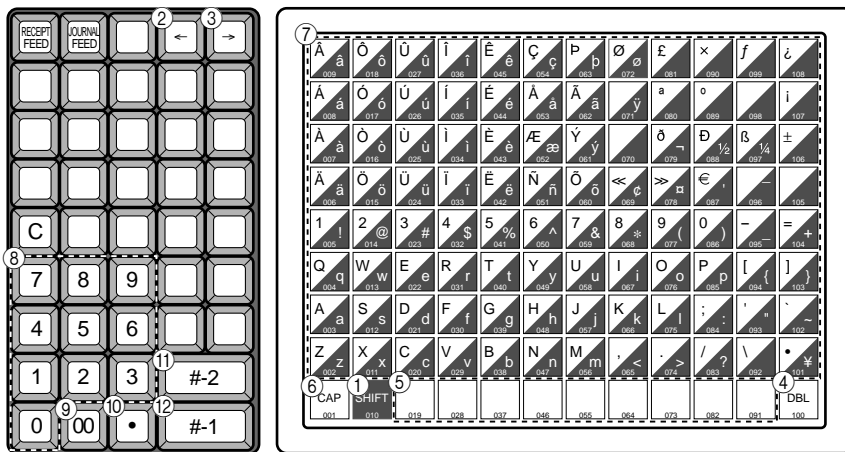

- ① **Shift key**
Pressing this key shifts the character from the uppercase letter to lower case letter and returns to the upper case letter in sequence.
- ② **Left cursor key**
Shifts the character setting position to the left one by one, and used to correct already entered characters.
- ③ **Right cursor key**
Shifts the character setting position to the right one by one, and used to correct already entered characters.

TK-7500

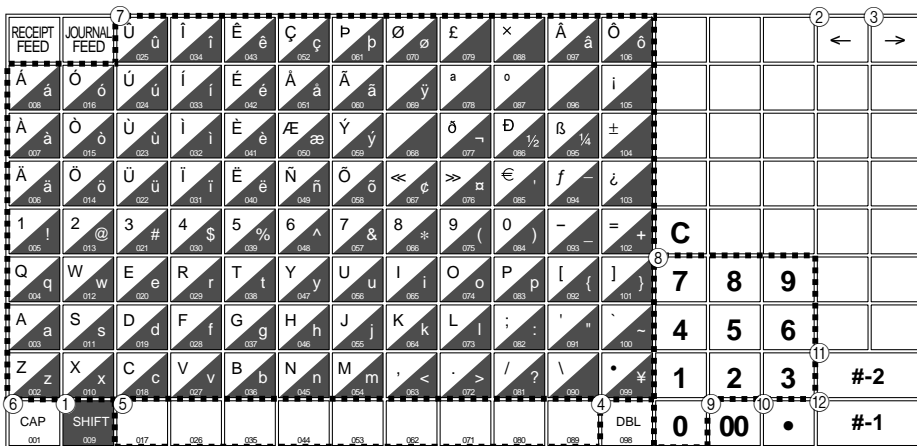

- ④ **Double size letter key**
Specifies that the next character you input to a double size character. You must press this key before each double size character.
- ⑤ **Space key**
Sets a space by depression.
- ⑥ **CAP key**
Shifts the character to the upper case letter.
- ⑦ **Alphabet keys**
Used input to characters.

- ⑧ **Numeric keys**
Used to enter program codes, memory number and character codes.
- ⑨ **Character fixed key**
Enter when the alphabetic entry for a descriptor, name or message has been completed.
- ⑩ **Backspace/Character code fixed key**
Registers one character with code (2 or 3 digit).
Clears the last input character, much like a back space key. (Does not clear the double size letter key entry.)
- ⑪ **Program end key**
Terminates the character programming.
- ⑫ **Character enter key**
Registers the programmed characters.

Advanced Operations

Entering characters by code

Every time you enter a character, choose character codes by the character code list (below) and press the  key to settle it. After you complete entering characters, press the **00** key to fix them.

Example:

Input “  P P l e J u i c e ”,
 enter “ 255  65  112  112  108  101  32  74  117  105  99  101  **00** ”

Character code list

Chara	Code	Chara	Code	Chara	Code	Chara	Code	Chara	Code	Chara	Code	Chara	Code
Space	32	0	48	À	64	P	80	`	96	ƒ	112	Ç	128
!	33	1	49	Á	65	Q	81	á	97	q	113	ü	129
"	34	2	50	B	66	R	82	b	98	r	114	é	130
#	35	3	51	C	67	S	83	c	99	s	115	â	131
\$	36	4	52	D	68	T	84	d	100	t	116	ä	132
%	37	5	53	E	69	U	85	e	101	u	117	à	133
&	38	6	54	F	70	V	86	f	102	v	118	å	134
'	39	7	55	G	71	W	87	g	103	w	119	ç	135
(40	8	56	H	72	X	88	h	104	x	120	ê	136
)	41	9	57	I	73	Y	89	i	105	y	121	ë	137
*	42	:	58	J	74	Z	90	j	106	z	122	è	138
+	43	;	59	K	75	[91	k	107	{	123	ì	139
,	44	<	60	L	76	\	92	l	108		124	î	140
-	45	=	61	M	77]	93	m	109	}	125	í	141
.	46	>	62	N	78	^	94	n	110	~	126	Ä	142
/	47	?	63	O	79	_	95	o	111		127	Å	143
É	144	á	160	ÿ	176	Ł	192	À	208	Ó	224	—	240
ê	145	í	161	ÿ	177	ł	193	Á	209	Ô	225	±	241
ë	146	ó	162	ÿ	178	ŕ	194	Â	210	Õ	226	…	242
ö	147	ú	163	ı	179	ŕ	195	Ë	211	Ö	227	‰	243
ö	148	ñ	164	ı	180	—	196	È	212	Ö	228	¶	244
ò	149	Ñ	165	Á	181	†	197	É	213	Û	229	§	245
û	150	#	166	Â	182	ā	198	Í	214	µ	230	÷	246
ù	151	€	167	Ã	183	Ā	199	Î	215	¶	231	„	247
ÿ	152	¿	168	Ä	184	ł	200	İ	216	Đ	232	°	248
Ö	153	®	169	ı	185	ŕ	201	ı	217	Ú	233	“	249
Ü	154	™	170	ı	186	ŕ	202	ŕ	218	Û	234	•	250
ø	155	ℓ	171	ŕ	187	ŕ	203	ı	219	Ü	235	ı	251
£	156	ℓ	172	ŕ	188	ı	204	ı	220	Ý	236	§	252
Ø	157	ı	173	€	189	—	205	ı	221	Ÿ	237	ž	253
×	158	«	174	¥	190	ı	206	ı	222	—	238	ı	254
f	159	»	175	ı	191	ı	207	ı	223	,	239	Double size	255

Editing characters

Correcting a character just entered

OPERATION	DISPLAY (dot)
“L” “E” “N” “O” “N” ⇐ Enter LENON, instead of LEMON.	
⇐ Press left arrow key three times.	
“M” ⇐ Enter “M”.	
⇐ Delete “N”.	

Correcting a PLU descriptor already set

OPERATION	DISPLAY (dot)
⇐ Enter PLU No.	
⇐ Press right arrow key two times.	
“M” ⇐ Enter “M”.	
⇐ Delete “N”.	

Correcting a key descriptor already set

OPERATION	DISPLAY (dot)
⇐ Enter “00”.	
⇐ Designate a department/transaction/flat-PLU key	
⇐ Press right arrow key two times.	
“M” ⇐ Enter “M”.	
⇐ Delete “N”.	

Correcting a message descriptor already set

OPERATION	DISPLAY (dot)
⇐ Enter record and file number.	
⇐ Press right arrow key two times.	
“O” ⇐ Enter “O”.	
⇐ Delete “A”.	

Printing read/reset reports

• Daily sales read report (“X1” mode)

You can print read reports at any time during the business day without affecting the data stored in the cash register's memory.

• Daily sales reset report (“Z1” mode)

You should print reset reports at the end of the business day.

Important!

- The reset operation issues a report and also clears all sales data from the cash register's memory.
- Be sure to perform the reset operations at the end of each business day. Otherwise, you will not be able to distinguish between the sales data for different dates.

To print the individual department, PLU/flat-PLU read report

This report shows sales for specific departments or PLUs/flat-PLUs.

OPERATION	REPORT
<div style="border: 1px solid black; padding: 5px; width: fit-content; margin: 0 auto;"> X1 <small>Mode switch</small> </div> <p style="text-align: center;">↓</p> <ul style="list-style-type: none"> • Specifying a department <div style="display: flex; justify-content: center; gap: 10px;"> 1, 2, 3 ~</div> • Specifying a PLU <div style="display: flex; justify-content: center; gap: 10px;"> 1 PLU ~</div> • Specifying a flat-PLU <div style="display: flex; justify-content: center; gap: 10px;"> 001, 002 ~</div> <p style="text-align: center;">↓</p> <div style="border: 1px solid black; padding: 2px; width: fit-content; margin: 0 auto;"> <small>SUB TOTAL</small> </div>	<pre> X 03-04-2000 19:00 Mode/date/time C01 MC#01 000532 Clerk/Mc No./consecutive No. X INDIVIDUAL Read symbol/report title DEPT01 38 Department Name/No. of items 8.13% +257.53 Sales ratio/amount OLD PRC -2.21 Old price amount RED PRC -4.18 Red price amount DISCOUNT -5.80 Discount amount PLU0001 17 PLU Name/No. of items 0.53% +17.00 Sales ratio/PLU amount OLD PRC -0.00 Old price amount RED PRC -2.18 Red price amount DISCOUNT -2.50 Discount amount #000001 PLU random code #000123 17 ----- TL 88.61 Total No. of items +516.10 Total amount RED PRC -12.18 Red amount total DISCOUNT -9.50 Discount amount total </pre>

After you finish to select items, press SUB TOTAL to terminate.

To print the financial read report

This report shows gross sales, net sales, cash in drawer and check in drawer.

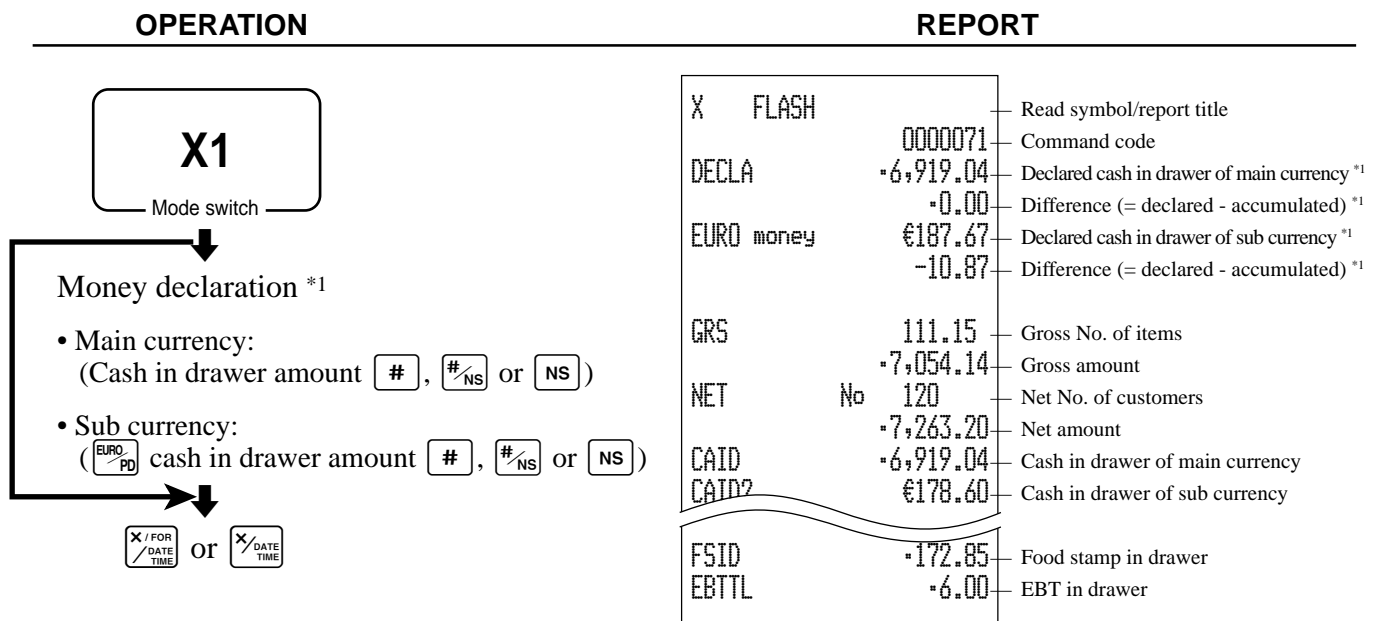

To print the individual clerk read/reset report

This report shows individual clerk totals.

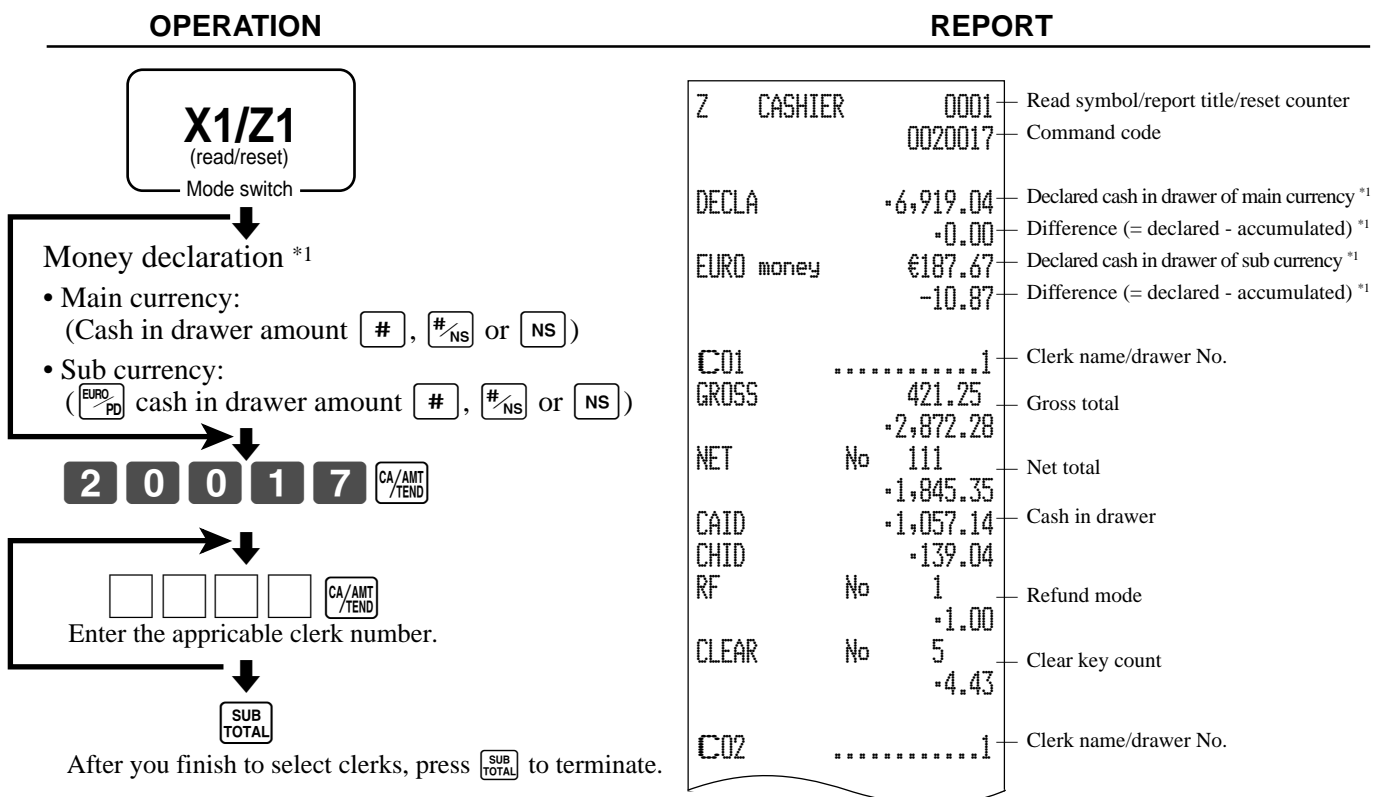

*1 Money declaration:

Count how much cash is in the drawer and input this amount (up to 10 digits).

The cash register will automatically compare the input with the cash in drawer in the memory and print the difference between these two amounts.

Note that if money declaration is required by programming, you cannot skip this procedure.

Advanced Operations

To print the daily sales read/reset report

This report shows sales except for PLUs.

OPERATION	REPORT																																																																																																																																				
<div style="border: 1px solid black; padding: 5px; display: inline-block;"> X1/Z1 (read/reset) Mode switch </div>																																																																																																																																					
Money declaration *1 • Main currency: (Cash in drawer amount <input type="checkbox"/> #, <input type="checkbox"/> #/NS or <input type="checkbox"/> NS) • Sub currency: (<input type="checkbox"/> EURO <input type="checkbox"/> PD cash in drawer amount <input type="checkbox"/> #, <input type="checkbox"/> #/NS or <input type="checkbox"/> NS)																																																																																																																																					
<div style="border: 1px solid black; padding: 2px; display: inline-block;"> CA / AMT / TEND </div>																																																																																																																																					
	<table border="1" style="width: 100%; border-collapse: collapse;"> <tbody> <tr> <td>Z</td> <td>BATCH01</td> <td></td> <td>Report title</td> </tr> <tr> <td>Z</td> <td>FIX</td> <td>0001</td> <td>Fixed total report title/reset counter *4</td> </tr> <tr> <td></td> <td></td> <td>0001011</td> <td>Report code</td> </tr> <tr> <td>DECLA</td> <td></td> <td>+6,919.04</td> <td>Declared cash in drawer of main currency *1</td> </tr> <tr> <td></td> <td></td> <td>-0.00</td> <td>Difference (= declared - accumulated) *1</td> </tr> <tr> <td>EURO money</td> <td></td> <td>€187.67</td> <td>Declared cash in drawer of sub currency *1</td> </tr> <tr> <td></td> <td></td> <td>-10.87</td> <td>Difference (= declared - accumulated) *1</td> </tr> <tr> <td>GROSS</td> <td></td> <td>981.25</td> <td>Gross total *3</td> </tr> <tr> <td></td> <td></td> <td>+6,574.40</td> <td></td> </tr> <tr> <td>NET</td> <td>No</td> <td>111</td> <td>Net total *3</td> </tr> <tr> <td></td> <td></td> <td>+7,057.14</td> <td></td> </tr> <tr> <td>CAID</td> <td></td> <td>+6,919.04</td> <td>Cash in drawer *3</td> </tr> <tr> <td>CHID</td> <td></td> <td>-139.04</td> <td>Charge in drawer *3</td> </tr> <tr> <td>CKID</td> <td></td> <td>-859.85</td> <td>Check in drawer *3</td> </tr> <tr> <td>CRID(1)</td> <td></td> <td>-709.85</td> <td>Credit in drawer *3</td> </tr> <tr> <td>RF</td> <td>No</td> <td>3</td> <td>Refund mode *3</td> </tr> <tr> <td></td> <td></td> <td>-10.22</td> <td></td> </tr> <tr> <td>CUST</td> <td>CT</td> <td>111</td> <td>Customer number *3</td> </tr> <tr> <td>AVRG</td> <td></td> <td>+63.57</td> <td>Average sales per customer *3</td> </tr> <tr> <td>DC</td> <td></td> <td>+1.22</td> <td>Discount total *3</td> </tr> <tr> <td>REF</td> <td></td> <td>+2.42</td> <td>Refund key *3</td> </tr> <tr> <td>CLEAR</td> <td>No</td> <td>85</td> <td>Clear key count *3</td> </tr> <tr> <td>ROUND</td> <td></td> <td>-0.00</td> <td>Rounding total *3</td> </tr> <tr> <td>CANCEL</td> <td>No</td> <td>2</td> <td>Cancellation *3</td> </tr> <tr> <td></td> <td></td> <td>-12.97</td> <td></td> </tr> <tr> <td>TA1</td> <td></td> <td>+2,369.69</td> <td>Taxable 1 amount *3</td> </tr> <tr> <td>TX1</td> <td></td> <td>-128.86</td> <td>Tax 1 amount *3</td> </tr> <tr> <td>TA2</td> <td></td> <td>+2,172.96</td> <td>Taxable 2 amount *3</td> </tr> <tr> <td>TX2</td> <td></td> <td>-217.33</td> <td>Tax 2 amount *3</td> </tr> <tr> <td>GT1</td> <td></td> <td>+00000000125478.96</td> <td>Grand total 1 *3</td> </tr> <tr> <td>GT2</td> <td></td> <td>+00000000346284.23</td> <td>Grand total 2 *3</td> </tr> <tr> <td>GT3</td> <td></td> <td>+00000000123212.75</td> <td>Grand total 3 *3</td> </tr> <tr> <td>Z</td> <td>TRANS</td> <td>0001</td> <td>Function key report title/reset counter</td> </tr> </tbody> </table>	Z	BATCH01		Report title	Z	FIX	0001	Fixed total report title/reset counter *4			0001011	Report code	DECLA		+6,919.04	Declared cash in drawer of main currency *1			-0.00	Difference (= declared - accumulated) *1	EURO money		€187.67	Declared cash in drawer of sub currency *1			-10.87	Difference (= declared - accumulated) *1	GROSS		981.25	Gross total *3			+6,574.40		NET	No	111	Net total *3			+7,057.14		CAID		+6,919.04	Cash in drawer *3	CHID		-139.04	Charge in drawer *3	CKID		-859.85	Check in drawer *3	CRID(1)		-709.85	Credit in drawer *3	RF	No	3	Refund mode *3			-10.22		CUST	CT	111	Customer number *3	AVRG		+63.57	Average sales per customer *3	DC		+1.22	Discount total *3	REF		+2.42	Refund key *3	CLEAR	No	85	Clear key count *3	ROUND		-0.00	Rounding total *3	CANCEL	No	2	Cancellation *3			-12.97		TA1		+2,369.69	Taxable 1 amount *3	TX1		-128.86	Tax 1 amount *3	TA2		+2,172.96	Taxable 2 amount *3	TX2		-217.33	Tax 2 amount *3	GT1		+00000000125478.96	Grand total 1 *3	GT2		+00000000346284.23	Grand total 2 *3	GT3		+00000000123212.75	Grand total 3 *3	Z	TRANS	0001	Function key report title/reset counter
Z	BATCH01		Report title																																																																																																																																		
Z	FIX	0001	Fixed total report title/reset counter *4																																																																																																																																		
		0001011	Report code																																																																																																																																		
DECLA		+6,919.04	Declared cash in drawer of main currency *1																																																																																																																																		
		-0.00	Difference (= declared - accumulated) *1																																																																																																																																		
EURO money		€187.67	Declared cash in drawer of sub currency *1																																																																																																																																		
		-10.87	Difference (= declared - accumulated) *1																																																																																																																																		
GROSS		981.25	Gross total *3																																																																																																																																		
		+6,574.40																																																																																																																																			
NET	No	111	Net total *3																																																																																																																																		
		+7,057.14																																																																																																																																			
CAID		+6,919.04	Cash in drawer *3																																																																																																																																		
CHID		-139.04	Charge in drawer *3																																																																																																																																		
CKID		-859.85	Check in drawer *3																																																																																																																																		
CRID(1)		-709.85	Credit in drawer *3																																																																																																																																		
RF	No	3	Refund mode *3																																																																																																																																		
		-10.22																																																																																																																																			
CUST	CT	111	Customer number *3																																																																																																																																		
AVRG		+63.57	Average sales per customer *3																																																																																																																																		
DC		+1.22	Discount total *3																																																																																																																																		
REF		+2.42	Refund key *3																																																																																																																																		
CLEAR	No	85	Clear key count *3																																																																																																																																		
ROUND		-0.00	Rounding total *3																																																																																																																																		
CANCEL	No	2	Cancellation *3																																																																																																																																		
		-12.97																																																																																																																																			
TA1		+2,369.69	Taxable 1 amount *3																																																																																																																																		
TX1		-128.86	Tax 1 amount *3																																																																																																																																		
TA2		+2,172.96	Taxable 2 amount *3																																																																																																																																		
TX2		-217.33	Tax 2 amount *3																																																																																																																																		
GT1		+00000000125478.96	Grand total 1 *3																																																																																																																																		
GT2		+00000000346284.23	Grand total 2 *3																																																																																																																																		
GT3		+00000000123212.75	Grand total 3 *3																																																																																																																																		
Z	TRANS	0001	Function key report title/reset counter																																																																																																																																		

<table border="0"> <tr><td colspan="3">0001012</td></tr> <tr><td>CASH</td><td>No</td><td>362</td></tr> <tr><td></td><td></td><td>-1,638.04</td></tr> <tr><td>CH</td><td>No</td><td>56</td></tr> <tr><td></td><td></td><td>-1,174.85</td></tr> <tr><td>RC</td><td>No</td><td>4</td></tr> <tr><td></td><td></td><td>-810.00</td></tr> <tr><td>PD</td><td>No</td><td>5</td></tr> <tr><td></td><td></td><td>-520.00</td></tr> <tr><td colspan="3">*J.00</td></tr> <tr><td>CORR</td><td>No</td><td>14</td></tr> <tr><td></td><td></td><td>-39.55</td></tr> <tr><td>VLD</td><td>No</td><td>19</td></tr> <tr><td>RCT</td><td>No</td><td>3</td></tr> <tr><td>NS</td><td>No</td><td>5</td></tr> <tr><td colspan="3">-----</td></tr> <tr><td>Z</td><td>DEPT</td><td>0001</td></tr> <tr><td></td><td></td><td>0001015</td></tr> <tr><td colspan="3">-----</td></tr> <tr><td>DEPT01</td><td></td><td>38</td></tr> <tr><td>8.13%</td><td></td><td>-257.53</td></tr> <tr><td>OLD PRC</td><td></td><td>-2.21</td></tr> <tr><td>RED PRC</td><td></td><td>-4.18</td></tr> <tr><td>DISCOUNT</td><td></td><td>-5.80</td></tr> <tr><td>DEPT02</td><td></td><td>183</td></tr> <tr><td></td><td></td><td>-1,362.26</td></tr> <tr><td colspan="3">-----</td></tr> <tr><td>RED PRC</td><td></td><td>127.54</td></tr> <tr><td>DISCOUNT</td><td></td><td>-17.22</td></tr> <tr><td colspan="3">-----</td></tr> <tr><td>TL</td><td></td><td>88.61</td></tr> <tr><td></td><td></td><td>-1,916.10</td></tr> <tr><td>RED PRC</td><td></td><td>-12.18</td></tr> <tr><td>DISCOUNT</td><td></td><td>-9.50</td></tr> <tr><td colspan="3">-----</td></tr> <tr><td>Z</td><td>CASHIER</td><td>0001</td></tr> <tr><td></td><td></td><td>0001017</td></tr> <tr><td colspan="3">-----</td></tr> <tr><td>C01</td><td></td><td>.....1</td></tr> <tr><td>GROSS</td><td></td><td>421.25</td></tr> <tr><td></td><td></td><td>-2,872.28</td></tr> <tr><td>NET</td><td>No</td><td>111</td></tr> <tr><td></td><td></td><td>-1,845.35</td></tr> <tr><td>CAID</td><td></td><td>-1,057.14</td></tr> <tr><td>CHID</td><td></td><td>-139.04</td></tr> </table>	0001012			CASH	No	362			-1,638.04	CH	No	56			-1,174.85	RC	No	4			-810.00	PD	No	5			-520.00	*J.00			CORR	No	14			-39.55	VLD	No	19	RCT	No	3	NS	No	5	-----			Z	DEPT	0001			0001015	-----			DEPT01		38	8.13%		-257.53	OLD PRC		-2.21	RED PRC		-4.18	DISCOUNT		-5.80	DEPT02		183			-1,362.26	-----			RED PRC		127.54	DISCOUNT		-17.22	-----			TL		88.61			-1,916.10	RED PRC		-12.18	DISCOUNT		-9.50	-----			Z	CASHIER	0001			0001017	-----			C01	1	GROSS		421.25			-2,872.28	NET	No	111			-1,845.35	CAID		-1,057.14	CHID		-139.04	<p>Report code</p> <p>Function key count/amount *2</p> <p>Department report title/reset counter</p> <p>Report code</p> <p>Department name/No. of items *2</p> <p>Sales ratio/amount *2</p> <p>Old price amount *2</p> <p>Red price amount *2</p> <p>Discount amount *2</p> <p>Total No. of items</p> <p>Total amount</p> <p>Red amount total</p> <p>Discount amount total</p> <p>Clerk report title/reset counter</p> <p>Report code</p> <p>Clerk name/drawer No.</p> <p>Gross total</p> <p>Net total</p> <p>Cash in drawer</p>
0001012																																																																																																																																								
CASH	No	362																																																																																																																																						
		-1,638.04																																																																																																																																						
CH	No	56																																																																																																																																						
		-1,174.85																																																																																																																																						
RC	No	4																																																																																																																																						
		-810.00																																																																																																																																						
PD	No	5																																																																																																																																						
		-520.00																																																																																																																																						
*J.00																																																																																																																																								
CORR	No	14																																																																																																																																						
		-39.55																																																																																																																																						
VLD	No	19																																																																																																																																						
RCT	No	3																																																																																																																																						
NS	No	5																																																																																																																																						

Z	DEPT	0001																																																																																																																																						
		0001015																																																																																																																																						

DEPT01		38																																																																																																																																						
8.13%		-257.53																																																																																																																																						
OLD PRC		-2.21																																																																																																																																						
RED PRC		-4.18																																																																																																																																						
DISCOUNT		-5.80																																																																																																																																						
DEPT02		183																																																																																																																																						
		-1,362.26																																																																																																																																						

RED PRC		127.54																																																																																																																																						
DISCOUNT		-17.22																																																																																																																																						

TL		88.61																																																																																																																																						
		-1,916.10																																																																																																																																						
RED PRC		-12.18																																																																																																																																						
DISCOUNT		-9.50																																																																																																																																						

Z	CASHIER	0001																																																																																																																																						
		0001017																																																																																																																																						

C01	1																																																																																																																																						
GROSS		421.25																																																																																																																																						
		-2,872.28																																																																																																																																						
NET	No	111																																																																																																																																						
		-1,845.35																																																																																																																																						
CAID		-1,057.14																																																																																																																																						
CHID		-139.04																																																																																																																																						
<table border="0"> <tr><td>RF</td><td>No</td><td>1</td></tr> <tr><td></td><td></td><td>-1.00</td></tr> <tr><td>CLEAR</td><td>No</td><td>5</td></tr> <tr><td></td><td></td><td>-4.43</td></tr> <tr><td colspan="3">-----</td></tr> <tr><td>C02</td><td></td><td>.....1</td></tr> </table>	RF	No	1			-1.00	CLEAR	No	5			-4.43	-----			C02	1	<p>Refund mode</p> <p>Clear key count</p> <p>Clerk name/drawer No.</p>																																																																																																																					
RF	No	1																																																																																																																																						
		-1.00																																																																																																																																						
CLEAR	No	5																																																																																																																																						
		-4.43																																																																																																																																						

C02	1																																																																																																																																						

*1 Money declaration:

Count how much cash is in the drawer and input this amount (up to 10 digits).

The cash register will automatically compare the input with the cash in drawer in the memory and print the difference between these two amounts.

Note that if money declaration is required by programming, you cannot skip this procedure.

*2 Zero totalled departments/functions (the amount and item numbers are both zero) are not printed.

*3 These items can be skipped by programming.

4 The “” symbol is printed on the reset report, memory overflow occurred in the counter/totalizer.

Advanced Operations

To print the PLU/flat-PLU read/reset report

This report shows sales for PLUs.

OPERATION	REPORT																																																																																
<div style="border: 1px solid black; padding: 5px; width: fit-content; margin: 0 auto;"> X1/Z1 (read/reset) Mode switch </div> <div style="text-align: center; margin: 5px 0;">↓</div> <div style="display: flex; justify-content: center; gap: 10px;"> <div style="border: 1px solid black; padding: 2px 10px;">0</div> <div style="border: 1px solid black; padding: 2px 10px;">1</div> <div style="border: 1px solid black; padding: 2px 10px;">4</div> <div style="border: 1px solid black; padding: 2px 10px; font-size: 8px;">CA/AMT /TEND</div> </div>	<table border="1" style="width: 100%; border-collapse: collapse;"> <tr> <td>X</td> <td>PLU</td> <td></td> <td>Read symbol/report title</td> </tr> <tr> <td></td> <td></td> <td>0000014</td> <td>Report code</td> </tr> <tr> <td>PLU0001</td> <td></td> <td>17</td> <td>PLU name/No. of items</td> </tr> <tr> <td>0.53%</td> <td></td> <td>-17.00</td> <td>Sales ratio/PLU amount</td> </tr> <tr> <td>OLD PRC</td> <td></td> <td>-0.00</td> <td>Old price amount</td> </tr> <tr> <td>RED PRC</td> <td></td> <td>-2.18</td> <td>Red price amount</td> </tr> <tr> <td>DISCOUNT</td> <td></td> <td>-2.50</td> <td>Discount amount</td> </tr> <tr> <td>#000001</td> <td></td> <td></td> <td>PLU random code</td> </tr> <tr> <td colspan="2" style="border-top: 1px solid black;">PLU0100</td> <td style="border-top: 1px solid black;">47</td> <td></td> </tr> <tr> <td></td> <td></td> <td>4.03%</td> <td></td> </tr> <tr> <td></td> <td></td> <td>-69.00</td> <td></td> </tr> <tr> <td>OLD PRC</td> <td></td> <td>-0.00</td> <td></td> </tr> <tr> <td>RED PRC</td> <td></td> <td>-5.18</td> <td></td> </tr> <tr> <td>DISCOUNT</td> <td></td> <td>-0.50</td> <td></td> </tr> <tr> <td>#000100</td> <td></td> <td></td> <td></td> </tr> <tr> <td colspan="4" style="border-top: 1px dashed black;"></td> </tr> <tr> <td>TL</td> <td></td> <td>188.61</td> <td>Total No. of items</td> </tr> <tr> <td></td> <td></td> <td>-516.10</td> <td>Total amount</td> </tr> <tr> <td>RED PRC</td> <td></td> <td>-12.18</td> <td>Red amount total</td> </tr> <tr> <td>DISCOUNT</td> <td></td> <td>-9.50</td> <td>Discount amount total</td> </tr> </table>	X	PLU		Read symbol/report title			0000014	Report code	PLU0001		17	PLU name/No. of items	0.53%		-17.00	Sales ratio/PLU amount	OLD PRC		-0.00	Old price amount	RED PRC		-2.18	Red price amount	DISCOUNT		-2.50	Discount amount	#000001			PLU random code	PLU0100		47				4.03%				-69.00		OLD PRC		-0.00		RED PRC		-5.18		DISCOUNT		-0.50		#000100								TL		188.61	Total No. of items			-516.10	Total amount	RED PRC		-12.18	Red amount total	DISCOUNT		-9.50	Discount amount total
X	PLU		Read symbol/report title																																																																														
		0000014	Report code																																																																														
PLU0001		17	PLU name/No. of items																																																																														
0.53%		-17.00	Sales ratio/PLU amount																																																																														
OLD PRC		-0.00	Old price amount																																																																														
RED PRC		-2.18	Red price amount																																																																														
DISCOUNT		-2.50	Discount amount																																																																														
#000001			PLU random code																																																																														
PLU0100		47																																																																															
		4.03%																																																																															
		-69.00																																																																															
OLD PRC		-0.00																																																																															
RED PRC		-5.18																																																																															
DISCOUNT		-0.50																																																																															
#000100																																																																																	
TL		188.61	Total No. of items																																																																														
		-516.10	Total amount																																																																														
RED PRC		-12.18	Red amount total																																																																														
DISCOUNT		-9.50	Discount amount total																																																																														

To print the hourly sales read/reset report

This report shows hourly breakdowns of sales.

OPERATION	REPORT																																																																				
<div style="border: 1px solid black; padding: 5px; width: fit-content; margin: 0 auto;"> X1/Z1 (read/reset) Mode switch </div> <div style="text-align: center; margin: 5px 0;">↓</div> <div style="display: flex; justify-content: center; gap: 10px;"> <div style="border: 1px solid black; padding: 2px 10px;">0</div> <div style="border: 1px solid black; padding: 2px 10px;">1</div> <div style="border: 1px solid black; padding: 2px 10px;">9</div> <div style="border: 1px solid black; padding: 2px 10px; font-size: 8px;">CA/AMT /TEND</div> </div>	<table border="1" style="width: 100%; border-collapse: collapse;"> <tr> <td>X</td> <td>HOURLY</td> <td></td> <td>Read symbol/report title</td> </tr> <tr> <td></td> <td></td> <td>0000019</td> <td>Report code</td> </tr> <tr> <td>00:00->01:00</td> <td></td> <td></td> <td>Time range</td> </tr> <tr> <td></td> <td>CT</td> <td>1</td> <td>No. of customers</td> </tr> <tr> <td>GROSS</td> <td></td> <td>-1.10</td> <td>Gross sales amount</td> </tr> <tr> <td>NET</td> <td>No</td> <td>1</td> <td>No. of receipt</td> </tr> <tr> <td>1.00%</td> <td></td> <td>-1.20</td> <td>Sales ratio/net sales amount</td> </tr> <tr> <td colspan="2" style="border-top: 1px solid black;">23:00->00:00</td> <td></td> <td></td> </tr> <tr> <td></td> <td>CT</td> <td>1</td> <td></td> </tr> <tr> <td>GROSS</td> <td></td> <td>-3.45</td> <td></td> </tr> <tr> <td>NET</td> <td>No</td> <td>1</td> <td></td> </tr> <tr> <td>3.90%</td> <td></td> <td>-3.59</td> <td></td> </tr> <tr> <td colspan="4" style="border-top: 1px dashed black;"></td> </tr> <tr> <td>TL</td> <td>CT</td> <td>280</td> <td>Total No. of customers</td> </tr> <tr> <td>GROSS</td> <td></td> <td>-1,937.61</td> <td>Gross total amount</td> </tr> <tr> <td>NET</td> <td>No</td> <td>25</td> <td>Total No. of receipt</td> </tr> <tr> <td></td> <td></td> <td>-2,096.80</td> <td>Net total amount</td> </tr> </table>	X	HOURLY		Read symbol/report title			0000019	Report code	00:00->01:00			Time range		CT	1	No. of customers	GROSS		-1.10	Gross sales amount	NET	No	1	No. of receipt	1.00%		-1.20	Sales ratio/net sales amount	23:00->00:00					CT	1		GROSS		-3.45		NET	No	1		3.90%		-3.59						TL	CT	280	Total No. of customers	GROSS		-1,937.61	Gross total amount	NET	No	25	Total No. of receipt			-2,096.80	Net total amount
X	HOURLY		Read symbol/report title																																																																		
		0000019	Report code																																																																		
00:00->01:00			Time range																																																																		
	CT	1	No. of customers																																																																		
GROSS		-1.10	Gross sales amount																																																																		
NET	No	1	No. of receipt																																																																		
1.00%		-1.20	Sales ratio/net sales amount																																																																		
23:00->00:00																																																																					
	CT	1																																																																			
GROSS		-3.45																																																																			
NET	No	1																																																																			
3.90%		-3.59																																																																			
TL	CT	280	Total No. of customers																																																																		
GROSS		-1,937.61	Gross total amount																																																																		
NET	No	25	Total No. of receipt																																																																		
		-2,096.80	Net total amount																																																																		

To print the monthly sales read/reset report

This report shows monthly breakdowns of sales.

OPERATION	REPORT																																																																																				
<div style="border: 1px solid black; padding: 5px; width: fit-content; margin: 0 auto;"> X1/Z1 (read/reset) Mode switch </div> <div style="text-align: center; margin: 5px 0;">↓</div> <div style="display: flex; justify-content: center; gap: 10px;"> <div style="border: 1px solid black; padding: 2px 10px;">0</div> <div style="border: 1px solid black; padding: 2px 10px;">2</div> <div style="border: 1px solid black; padding: 2px 10px;">0</div> <div style="border: 1px solid black; padding: 2px 5px; font-size: 8px;">CA/AMT /TEND</div> </div>	<table style="width: 100%; border-collapse: collapse;"> <tr> <td style="width: 10%;">X</td> <td style="width: 40%;">MONTHLY</td> <td style="width: 10%;"></td> <td style="width: 40%;">Read symbol/report title</td> </tr> <tr> <td></td> <td></td> <td style="text-align: right;">0000020</td> <td>Report code</td> </tr> <tr> <td></td> <td>1.....</td> <td></td> <td>Date of a month</td> </tr> <tr> <td>GROSS</td> <td></td> <td style="text-align: right;">1236.76</td> <td>Gross symbol/No. of items</td> </tr> <tr> <td></td> <td></td> <td style="text-align: right;">-12,202.57</td> <td>Gross sales amount</td> </tr> <tr> <td>NET</td> <td>No</td> <td style="text-align: right;">214</td> <td>Net symbol/No. of customers</td> </tr> <tr> <td></td> <td></td> <td style="text-align: right;">-12,202.57</td> <td>Net sales amount</td> </tr> <tr> <td colspan="4" style="border-top: 1px dashed black;"></td> </tr> <tr> <td></td> <td>31.....</td> <td></td> <td></td> </tr> <tr> <td>GROSS</td> <td></td> <td style="text-align: right;">2132</td> <td></td> </tr> <tr> <td></td> <td></td> <td style="text-align: right;">-14,187.57</td> <td></td> </tr> <tr> <td>NET</td> <td>No</td> <td style="text-align: right;">205</td> <td></td> </tr> <tr> <td></td> <td></td> <td style="text-align: right;">-13,398.76</td> <td></td> </tr> <tr> <td colspan="4" style="border-top: 1px dashed black;"></td> </tr> <tr> <td>TL</td> <td></td> <td></td> <td>Total symbol</td> </tr> <tr> <td>GROSS</td> <td></td> <td style="text-align: right;">9746.63</td> <td>Gross symbol/No. of items</td> </tr> <tr> <td></td> <td></td> <td style="text-align: right;">-161,022.49</td> <td>Gross sales amount</td> </tr> <tr> <td></td> <td></td> <td style="text-align: right;">-16.52</td> <td>Average daily gross sales</td> </tr> <tr> <td>NET</td> <td>No</td> <td style="text-align: right;">2351</td> <td>Net symbol/No. of customers</td> </tr> <tr> <td></td> <td></td> <td style="text-align: right;">-161,022.49</td> <td>Net sales amount</td> </tr> <tr> <td></td> <td></td> <td style="text-align: right;">-68.49</td> <td>Average daily net sales</td> </tr> </table>	X	MONTHLY		Read symbol/report title			0000020	Report code		1		Date of a month	GROSS		1236.76	Gross symbol/No. of items			-12,202.57	Gross sales amount	NET	No	214	Net symbol/No. of customers			-12,202.57	Net sales amount						31			GROSS		2132				-14,187.57		NET	No	205				-13,398.76						TL			Total symbol	GROSS		9746.63	Gross symbol/No. of items			-161,022.49	Gross sales amount			-16.52	Average daily gross sales	NET	No	2351	Net symbol/No. of customers			-161,022.49	Net sales amount			-68.49	Average daily net sales
X	MONTHLY		Read symbol/report title																																																																																		
		0000020	Report code																																																																																		
	1		Date of a month																																																																																		
GROSS		1236.76	Gross symbol/No. of items																																																																																		
		-12,202.57	Gross sales amount																																																																																		
NET	No	214	Net symbol/No. of customers																																																																																		
		-12,202.57	Net sales amount																																																																																		
	31																																																																																				
GROSS		2132																																																																																			
		-14,187.57																																																																																			
NET	No	205																																																																																			
		-13,398.76																																																																																			
TL			Total symbol																																																																																		
GROSS		9746.63	Gross symbol/No. of items																																																																																		
		-161,022.49	Gross sales amount																																																																																		
		-16.52	Average daily gross sales																																																																																		
NET	No	2351	Net symbol/No. of customers																																																																																		
		-161,022.49	Net sales amount																																																																																		
		-68.49	Average daily net sales																																																																																		

To print the group read/reset report

This report shows PLU/subdepartment/department group totals.

OPERATION	REPORT																																																								
<div style="border: 1px solid black; padding: 5px; width: fit-content; margin: 0 auto;"> X1/Z1 (read/reset) Mode switch </div> <div style="text-align: center; margin: 5px 0;">↓</div> <div style="display: flex; justify-content: center; gap: 10px;"> <div style="border: 1px solid black; padding: 2px 10px;">0</div> <div style="border: 1px solid black; padding: 2px 10px;">1</div> <div style="border: 1px solid black; padding: 2px 10px;">6</div> <div style="border: 1px solid black; padding: 2px 5px; font-size: 8px;">CA/AMT /TEND</div> </div>	<table style="width: 100%; border-collapse: collapse;"> <tr> <td style="width: 10%;">X</td> <td style="width: 40%;">GROUP</td> <td style="width: 10%;"></td> <td style="width: 40%;">Read symbol/report title</td> </tr> <tr> <td></td> <td></td> <td style="text-align: right;">0000016</td> <td>Report code</td> </tr> <tr> <td>GROUP01</td> <td></td> <td style="text-align: right;">203.25</td> <td>Group No./No. of items</td> </tr> <tr> <td></td> <td>33.87%</td> <td style="text-align: right;">-1,108.54</td> <td>Sales ratio/group amount</td> </tr> <tr> <td>GROUP02</td> <td></td> <td style="text-align: right;">183</td> <td></td> </tr> <tr> <td></td> <td>40.58%</td> <td style="text-align: right;">-1,327.80</td> <td></td> </tr> <tr> <td>GROUP03</td> <td></td> <td style="text-align: right;">12</td> <td></td> </tr> <tr> <td></td> <td></td> <td style="text-align: right;">-13.25</td> <td></td> </tr> <tr> <td colspan="4" style="border-top: 1px dashed black;"></td> </tr> <tr> <td>GROUP99</td> <td></td> <td style="text-align: right;">13</td> <td></td> </tr> <tr> <td></td> <td>0.54%</td> <td style="text-align: right;">-17.80</td> <td></td> </tr> <tr> <td colspan="4" style="border-top: 1px dashed black;"></td> </tr> <tr> <td>TL</td> <td></td> <td style="text-align: right;">862</td> <td>Group total No. of items</td> </tr> <tr> <td></td> <td></td> <td style="text-align: right;">-3,272.00</td> <td>Group total amount</td> </tr> </table>	X	GROUP		Read symbol/report title			0000016	Report code	GROUP01		203.25	Group No./No. of items		33.87%	-1,108.54	Sales ratio/group amount	GROUP02		183			40.58%	-1,327.80		GROUP03		12				-13.25						GROUP99		13			0.54%	-17.80						TL		862	Group total No. of items			-3,272.00	Group total amount
X	GROUP		Read symbol/report title																																																						
		0000016	Report code																																																						
GROUP01		203.25	Group No./No. of items																																																						
	33.87%	-1,108.54	Sales ratio/group amount																																																						
GROUP02		183																																																							
	40.58%	-1,327.80																																																							
GROUP03		12																																																							
		-13.25																																																							
GROUP99		13																																																							
	0.54%	-17.80																																																							
TL		862	Group total No. of items																																																						
		-3,272.00	Group total amount																																																						

Advanced Operations

• Periodic sales read report (“X2” mode)

You can print read reports at any time during the business day without affecting the data stored in the cash register's memory.

• Periodic sales reset report (“Z2” mode)

You should print reset reports at the end of the business day.

To print the periodic 1/2 sales read/reset reports

These reports show sales breakdowns of sales by any two kinds of period you want.

OPERATION	REPORT
<div style="border: 1px solid black; padding: 5px; width: fit-content; margin: 0 auto;"> <p>X2/Z2 (read/reset)</p> <p>Mode switch</p> </div> <p style="text-align: center;">↓</p> <div style="display: flex; align-items: center; justify-content: center;"> <div style="border: 1px solid black; padding: 2px 5px; margin-right: 5px;">1</div> <div style="border: 1px solid black; padding: 2px 5px;">CA/AMT /TEND</div> </div>	<pre> ----- ZZ1 BATCH02 ----- ZZ1 FIX 0001 0001111 ----- GROSS 981.25 -6,574.40 NET No 111 -7,057.14 CAID -6,919.04 CHID -139.04 CKID -859.85 CRID(1) -709.85 ----- RF No 3 -10.22 CUST CT 111 AVRG -63.57 DC -1.22 REF -2.42 CLEAR No 85 ROUND -0.00 CANCEL No 2 -12.97 ----- TA1 -2,369.69 TX1 -128.86 TA2 -2,172.96 TX2 -217.33 ----- ZZ1 TRANS 0001 0001112 CASH No 362 -1,638.04 CH No 56 -1,174.85 RC No 4 -810.00 PD No 5 </pre>

		-5.00	
CORR	No	14	
		-39.55	
ULD	No	19	
RCT	No	7	
NS	No	5	

ZZ1 DEPT		0001	Department report title/reset counter
		0001115	Report code
DEPT01		38	Department Name/No. of items *1
8.13%		-257.53	Sales ratio/amount *1
OLD PRC		-2.21	Old price amount *1
RED PRC		-4.18	Red price amount *1
DISCOUNT		-5.80	Discount amount *1
DEPT02		183	
		-1,362.26	
RED PRC		-123.21	
DISCOUNT		-17.22	

TL		88.61	Total No. of items
		-1,916.10	Total amount
RED PRC		-12.18	Red amount total
DISCOUNT		-9.50	Discount amount total

ZZ1 CASHIER		0001	Clerk report title/reset counter
		0001117	Report code
C01	1	Clerk name/drawer No.
GROSS		421.25	Gross total
		-2,872.28	
NET	No	111	Net total
		-1,845.35	
CAID		-1,057.14	Cash in drawer
CHID		-139.04	
RF	No	1	Refund mode
		-1.00	
CLEAR	No	5	Clear key count
		-4.43	
C02	1	Clerk name/drawer No.

*1 Zero totalled departments/functions (the amount and item numbers are both zero) are not printed.

*2 These items can be skipped by programming.

Advanced Operations

To print other sales read/reset reports

The following reports can be issued.

Procedure

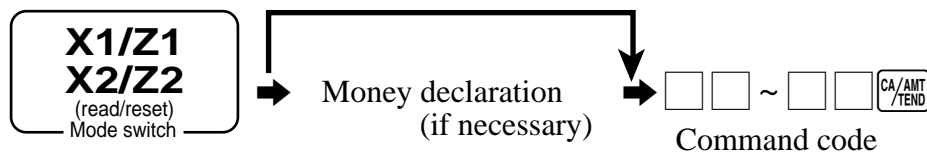

Report/command code list

Report name	Command code Read #=0/Reset # = 1			Report name	Command code Read #=0/Reset # = 1		
	Daily	Periodic 1	Periodic 2		Daily	Periodic 1	Periodic 2
Fix totalizer	11	#111	#211	Department	15	#115	#215
Transaction key	12	#112	#212	best 50 (amount order)	60015	60115	60215
Subdepartment	13	#113	#213	best 50 (quantity order)	70015	70115	70215
PLU by record number (all) *	14	#114	#214	Group	16	#116	#216
all PLU by random code *	14	#114	#214	Clerk	17	#117	#217
by group	1000014	100#114	100#214	individual	2017	2#117	2#217
by department	2000014	200#114	200#214	Hourly sales	19	#119	#219
by subdepartment	3000014	300#114	300#214	Monthly sales	20	#120	#220
individual by group	1020014	102#114	102#214	Open check	25	----	----
individual by department	2020014	202#114	202#214	total	40025	----	----
individual by subdepartment	3020014	302#114	302#214	Scanning PLU by range department (all)	26	----	----
range by record number *	10014	1#114	1#214	by range group	1000026	----	----
range by random code *	10014	1#114	1#214	by range department	2000026	----	----
best 50 (amount order)	60014	60114	60214	by range subdepartment	3000026	----	----
best 50 (quantity order)	70014	70114	70214	best 50 by range department	80026	----	----
menu (1st)	81	#181	#281	inactive item by range department	90026	----	----
menu (2nd)	82	#182	#282	Not found PLU by range department (all)	27	----	----
menu (3rd)	83	#183	#283	Table analysis	28	#128	#228
menu (4th)	84	#184	#284	Hourly item	31	#131	#231
menu (5th)	85	#185	#285	Mix & match	61	#161	#261
menu (6th)	86	#186	#286	Financial	71	----	----
PLU stock all PLU by record number *	64	----	----	Individual (item/transaction key)	No code	----	----
all PLU by random code *	64	----	----	PLU reset (no report)	50014	51114	51214
by group	1000064	----	----	Scanning PLU reset (no report)	50026	----	----
by department	2000064	----	----	Not found PLU reset (no report)	50027	----	----
by subdepartment	3000064	----	----	Not found PLU file reset (incl. program)	80027	----	----
individual by group	1020064	----	----	Not found PLU maintenance file reset	80082	----	----
individual by department	2020064	----	----				
individual by subdepartment	3020064	----	----				
range by record number *	10064	----	----				
range by random code *	10064	----	----				

* You can choose by record number/by random code by program.

Reading the cash register's program

To print unit price/rate program (except PLU/scanning PLU)

OPERATION

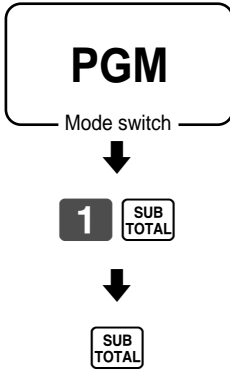

REPORT

P01.....		Program read symbol
CASH	@100.00	Transaction key unit price or rate
CHECK	@1.00	
-	@1.00	
%-	10%	
<hr/>		
DEPT01	0001-05	Department descriptor/rec-#/file-#
1.2	@1.00	Unit quantity/unit price
DEPT02	0002-05	
1	@2.00	

Advanced Operations

To print key descriptor, name, message program (except PLU)

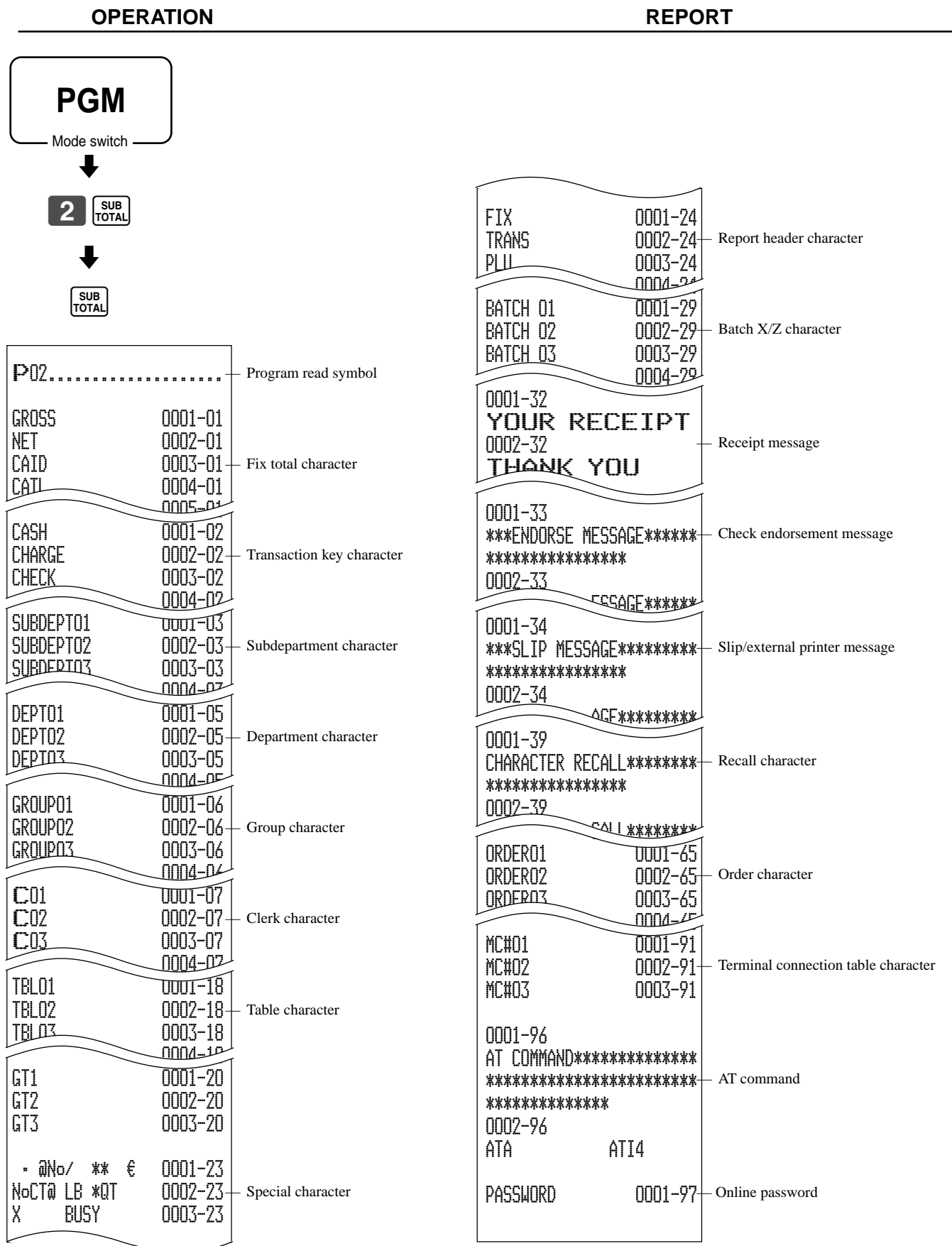

To print the PLU/flat-PLU program

OPERATION

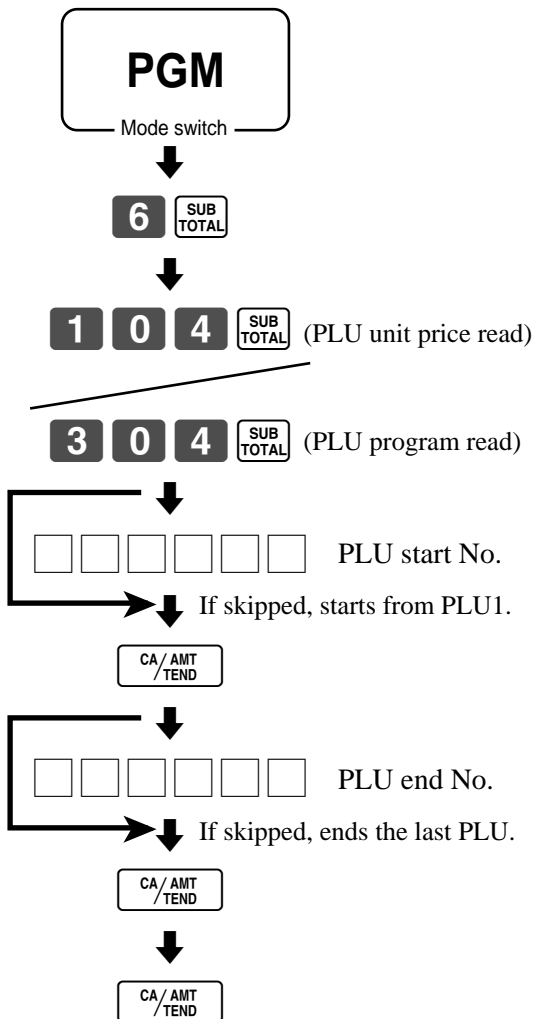

REPORT

P01.....	Program read symbol
#000001 - #999999	Read range
PLU0001 0001-04	Item character/rec-#/file-#
#000001	Random code
1.2 @1.00	Unit quantity/unit price
PLU0002 0002-04	
#000002	
1 @2.00	

P03.....	Program read symbol
#000001 - #999999	Read range
PLU0001 0001-04	Item character/rec-#/file-#
0000000000000000	Batch program 01 ~ 1066, 18 ~ 1966
11-66 000000	Batch program 1166
12-66 #000001	Batch program 1266
13-66 <- 0001-28	Batch program 1366
14-66 0	Batch program 1466
15-66 @1234.56	Batch program 1566
16-66 000000	Batch program 1666
17-66 00	Batch program 1766
PLU0002 0002-04	
0000000000000000	
11-66 000000	

Troubleshooting

This section describes what to do when you have problems with operation.

When an error occurs

Errors are indicated by an error codes. When this happens, you can usually find out what the problem is as shown below.

Press **C** and check the appropriate section of this manual for the operation you want to perform.

Error code	Message	Meaning	Action
E001	Wrong mode	Mode switch position changed before finalization.	Return the mode switch to its original setting and finalize the operation.
E003	Wrong operator	Clerk button pressed before finalization of a registration being performed under another clerk button. The signed on clerk differs from the clerk performed the tracking check registration.	Press the original clerk button and finalize the transaction before pressing another clerk button. Input correct check number or assign the proper clerk number.
E004	Error INIT/FC	Initialization or unit lock clear operation in progress.	Complete operation.
E005	Insufficient memory	Memory allocation exceeds total memory capacity.	Reallocate memory or expand memory (if possible).
E008	Please sign on	Registration without entering a clerk number.	Enter a clerk number.
E009	Enter password	Operation without entering the password.	Enter password.
E010	Close the drawer	The drawer is left open longer than the program time (drawer open alarm).	Close the drawer.
E011	Close the drawer	Attempt to register while the cash drawer is open.	Shut the cash drawer.
E013	Journal paper near end	Journal paper near end. (option)	Replace the journal paper.
E015	Check R/J printer	Printer error	
E016	Change back to REG mode	Two consecutive transactions attempted in the refund mode.	Switch to another mode and then back to the RF mode for the next transaction.
E017	Enter CHK/TBL number	Attempt made to register an item without inputting a check number.	Input a check number.
E018	Enter Table number	Attempt made to register an item without inputting a table number.	Input a table number.
E019	Enter number of customers	Finalize operation attempted without entering the number of customer.	Enter the number of customer.
E021	No Dept Link	No department linked PLU is registered.	Correct the program.
E022	Not found PLU	PLU code is not found in the scanning PLU file.	Perform department registration.
E023	Stock shortage	Actual stock quantity becomes less than the minimum stock quantity.	Perform stock maintenance.
E024	No stock	Actual stock quantity becomes/is negative.	Perform stock maintenance.
E025	Illegal scale read or entry	Scale read error/perform non-scale registration to scalable item.	Retry registration/register to a proper department or PLU.
E026	Enter condiment/preparation PLU	No condiment/preparation PLU is registered.	Register condiment/preparation PLU.
E029	In the tender operation	Item registration is prohibited, while partial tender.	Finalize the transaction.
E030	Press RATE TAX key	Finalization of a transaction attempted without registering rate-tax.	Register <RATE TAX>.
E031	Press ST key	Finalization of a transaction attempted without confirming the subtotal.	Press <SUBTOTAL>.
E032	Press FSST key	Finalization of a transaction attempted without confirming of the food stamp subtotal.	Press <FS/ST>.
E033	Enter tender amount	Finalize operation attempted without entering amount tender.	Enter the amount tendered.
E035	Change amount exceeds limit	Change amount exceeds preset limit.	Input amount tendered again.
E036	Remove money from the drawer	Contents of the drawer exceed programmed limit.	Perform pick up operation.
E037	Digit or amount limitation over	High amount lock out/low digit lock out error	Enter correct amount.
E038	Perform money declaration	Read/reset operation without declaring cash in drawer. This error appears only when this function is activated.	Perform money declaration.
E040	Issue guest receipt	Attempt to register a new transaction without issuing a guest receipt.	Issue a guest receipt.
E041	Print validation	Attempt to register a new transaction without validation.	Perform validation operation.
E044	Print cheque	Attempt to register a new transaction without printing check.	Perform check print.
E045	Print Cheque Endorsement	Attempt to register a new transaction without printing check endorsement.	Perform check endorsement.
E046	REG buffer full	Registration buffer full. Separate check buffer full.	Finalize the transaction. Allocate sufficient separate check buffer.
E047	Print bill	Attempt to register a new transaction without printing slip.	Perform slip printing operation.
E048	Insert slip paper and retry	No paper is inserted or paper is out in the slip printer.	Insert new slip paper.

Troubleshooting

Error code	Message	Meaning	Action
E049	CHECK memory full	Check tracking index memory full.	Finalize and close the check number currently used.
E050	DETAIL memory full	Check tracking detail memory full.	Finalize and close the check number currently used.
E051	CHK/TBL No. is occupied	Attempt to made use <NEW CHECK> to open a new check using a number that is already used for an existing check in check tracking memory.	Finalize and close the check that is currently under the number that you want to use or use a different check number.
E053	CHK/TBL No. is not opened	Attempt made to use <OLD CHECK> reopen a new check using a number that is not used for an existing check in check tracking memory.	Use the correct check number (if you want to reopen a check that already exists in check tracking memory) or use <NEW CHECK> to open a new check.
E054	Out of CHK/TBL No. range	Check number range over.	Enter correct number.
E055	In the SEP CHK operation	Normal registration is prohibited during separate check operation.	Terminate separate check operation.
E059	Press EAT-IN or TAKE-OUT key	Attempt to finalize a transaction without specifying <EAT-IN> or <TAKE-OUT>.	Press <EAT-IN> or <TAKE-OUT>.
E060	Printer offline	External printer offline	
E061	Printer error	External printer went down.	
E062	Printer paper end	External printer paper end	Replace new paper.
E063	Printer busy	External printer is now printing.	
E064	Print buffer full	Printing buffer full	
E066	Print from the beginning of the transaction	Attempt to print the last separated transaction on slip.	Print from the beginning of the transaction
E075	Negative balance cannot be finalized	Attempt to finalize a transaction when balance is less than or equal to zero.	Register item(s) until the balance becomes positive amount.
E085	Data exist in consolidation file	Data exists in the consolidation file.	Clear the data.
E099	Check NFP items	Disable to read/reset or consolidate the not found PLU item.	
E100	Operate at master terminal	Prohibit master operation.	Perform it at master terminal.
E101	PLU maintenance file full. Press <#2> to exit	Scanning PLU direct maintenance/batch maintenance file becomes full.	Terminate the maintenance.
E102	NFP maintenance file full. Press <#2> to exit	Not found PLU maintenance file becomes full.	Terminate the maintenance
E105	PLU file full	Scanning PLU/not found PLU file full	
E121	Inline startup error	Network startup error.	
E139	Negative balance is not allowed	Attempt to register <-> or <CPN> when the balance becomes negative.	Enter proper minus/coupon amount.
E146	Arrangement file full	Arrangement file is full.	Set the arrangement properly.
E200	Insert RAC-9	No memory cassette is set.	Set memory cassette.
E202	File not found	Can not read, because no designated file is in the memory cassette or internal flash memory.	Check the operation and retry.
E203	Insufficient memory	Insufficient memory in the memory cassette or internal flash memory.	Use a vacant (formatted) memory cassette.
E204	Check the write protect switch	Write protect switch of the memory cassette is on.	Check the write protect switch.
E205	File already exist.	Can not write, because designated file has already been in the memory cassette or internal flash memory.	Check the operation and retry.

When the register does not operate at all

Perform the following check whenever the cash register enter an error condition as soon as you switch it on. The results of this check are required by service personnel, so be sure to perform this check before you contact a CASIO representative for servicing.

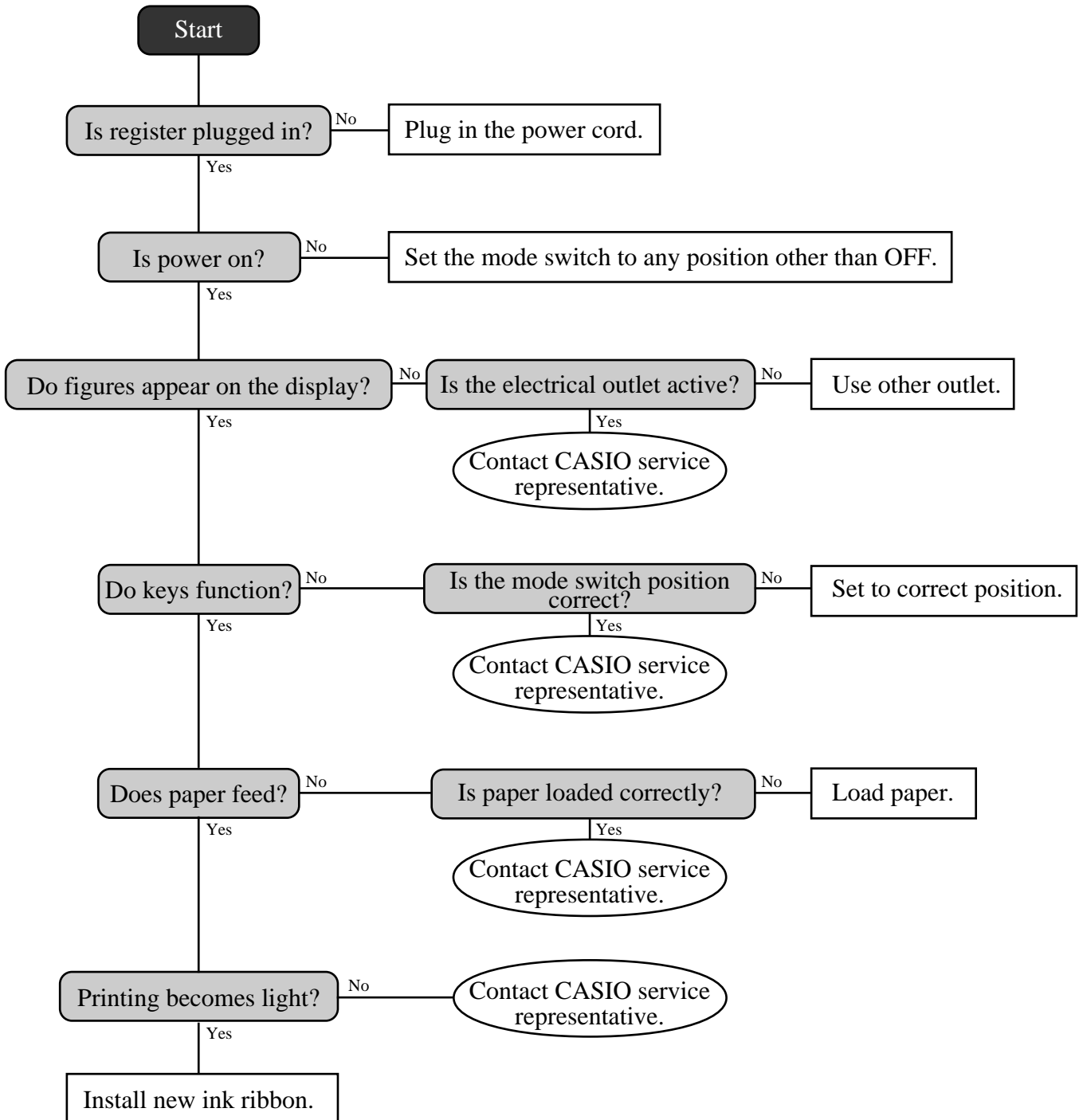

Clearing a machine lock up

If you make a mistake in operation, the cash register may lock up to avoid damage to programs and preset data. Should it happens, you can use the following procedure to clear the lock up without losing any data.

- 1 Power off the register.
- 2 Insert the PGM key in the mode switch.
- 3 Press down **RECEIPT FEED**, and turn the mode switch to PGM mode.
- 4 The display shows ten Fs, then release **RECEIPT FEED**.
- 5 Press **SUB TOTAL**. The display shows ten Fs and issue a receipt.

Important!

- If the register does not show ten Fs, never press **SUB TOTAL** and call service representative.

In case of power failure

If the power supply to the cash register is cut by a power failure or any other reason, simply wait for power to be restored. The details of any on-going transaction as well as all sales data in memory are protected by the memory backup batteries.

- Power failure during a registration
The subtotal for items registered up to the power failure is retained in memory. You will be able to continue with the registration when power is restored.
- Power failure during printing a read/reset report
The data already printed before the power failure is retained in memory. You will be able to issue a report when power is restored.
- Power failure during printing of a receipt and the journal
Printing will resume after power is restored. A line that was being printed when the power failure occurred is printed in full.
- Other
The power failure symbol is printed and any item that was being printed when the power failure occurred is reprinted in full.

The memory protection battery is constantly charging and discharging as you switch the cash register on and off during normal operations. This causes the capacity of the battery to decrease after approximately five years of use.

Important !

- Remember ...a weak battery has the potential of losing valuable transaction data.
- A label on the back of the cash register shows the normal service period of the battery installed in your cash register.
- Have the battery replaced by your dealer within the period noted on this label.

To replace the ink ribbon



1

Open the printer cover.



4

Load a new ink ribbon cassette into the unit.



2

Remove the printer sub cover.

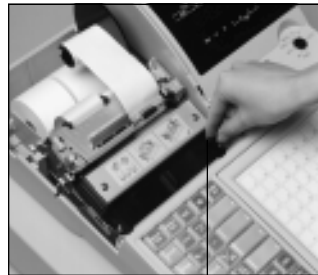

5

Turn the knob on the right side of the cassette to take up any slack in the ribbon.

Knob



3

Pull up the knob of the ribbon cassette.

6

Reload the roll paper and replace the printer cover and printer sub cover.

Important!

Use only the ERC-32(P) ribbon (purple). Other types of ink ribbons can damage the printer. Never try to extend the life of an ink ribbon by replenishing the ink. Once an ink ribbon is in place, press <#/NS> or <NS> to test for correct operation.

To replace journal paper

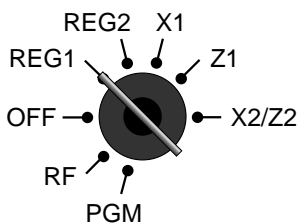

1

Set the mode switch to the REG1 position and remove the printer cover.



2

Press **JOURNAL FEED** to feed about 20 cm of paper.



6

Cut the journal paper as shown in the photograph.



3

Cut the journal paper at the point where nothing is printed.



7

Press **JOURNAL FEED** to feed the remaining paper from the printer.



4

Remove the journal take-up reel from its holder.



8

Do not pull the paper out of the printer by hand. It can damage the printer.



5

Slide the printed journal from the take-up reel.



9

Remove the old paper roll from the cash register.

10

Load new paper as described on page 10 of this manual.

To replace receipt paper

Follow step ① under “To replace journal paper” on the previous page.



②

Cut the receipt paper as shown in the photograph.



④

Do not pull the paper out of the printer by hand. It can damage the printer.



③

Press **RECEIPT FEED** to feed the remaining paper from the printer.



⑤

Remove the old paper roll from the cash register.

⑥

Load new paper as described on page 11 of this manual.

To replenish the stamp ink

Follow step ① under “To replace journal paper” on the previous page.



②

Remove the stamp pad from its holder by lifting the knob.

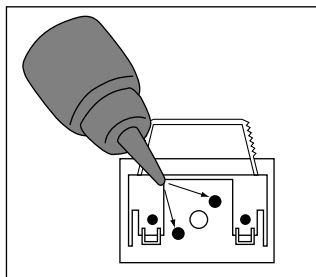

③

Squirt one or two drops of ink into the holes on the back of the stamp pad.

④

Replace the stamp pad on its holder.

Options

Wetproof cover: WT-78,
WT-79 (For TK-7000)
Memory chip: RAM-610-10LL
Memory cassette: RAC-9
Hand held scanner: HHS-15

Slip printer: SP-1300
Cable: PRT-CB-8C
External printer: UP-350, UP-250
Cable: PRT-CB-8A or PRT-CB-8B
Power supply: PS-170 and AC-170

Consult with your CASIO dealer for details.

Specifications

Input method

Entry: 10-key system, buffer memory 8 keys (2-key roll over)
 Department: Full key system

Display

Amount 10 digits (zero suppression); No. of repeats, total, change, receipt on/off, transaction indicator
 Descriptor 16 digits × 2 lines; item descriptor, No. of items, mode, clerk name

Printer

Receipt: Dot matrix alpha-numeric system 24 digits, receipt on/off switch (key)
 Store name or slogan is printed automatically
 Logo stamp: 20 (H) × 30 (W) mm
 Journal: Dot matrix alpha-numeric system 24 digits
 Automatic take up roll winding
 Journal paper near end sensor (option)
 Validation: 55 digits, one line, for 135 mm (minimum) wide slip
 Paper roll: 45 (W) × 83 (D) mm
 Paper feed: Separate for receipt and journal
 Print speed: 3.0 l/s

Listing capacity

Amount: 99999999
 Quantity: 9999,999
 Tended amount: 9999999999
 Percent: 99.99
 Tax rate: 9999.9999
 Numbers: 9999999999999999

Chronological data

Date print: Automatic date printout on receipt or journal, automatic calendar
 Time print: Automatic time printout on receipt or journal, 24-hour system/12-hour system

Alarm

Key catch tone, error alarm, sentinel alarm

Memory protection battery

48-hour full charge protects memories for approximately 90 days.
 Battery should be replaced every five years.

Power supply/power consumption

See the rating plate.

Operation temperature

0°C ~ 40°C (32°F ~ 104°F)

Humidity

10 ~ 90%

Dimensions and weight

454mm (H) × 345mm (W) × 218mm (D) /6.5kg
 17^{7/8}" (H) × 13^{9/16}" (W) × 8^{9/16}" (D)/14lbs. 5oz.
 ...without drawer

Totalizers		Contents				Periodic totalizers
Category	No. of totalizers	Amount (10 digits)	No. of items (6 integer/3 decimal)	Count (4 digits)	No. of customers (6 digits)	
Department	Up to 10	✓	✓			✓
PLU	Up to 216	✓	✓			
Clerk	15	✓	✓	✓		✓
Hourly sales	24	✓			✓	
Monthly sales	31	✓	✓		✓	
Transaction	Variable with program	Variable with program				✓
Non resettable grand total	3	✓ (16 digits)				
Reset counter	12/15			✓		
Consecutive No.	1			✓ (6 digits)		

* Specifications and design are subject to change without notice.

A

add check 24, 84
adding to a check 81
addition (+) 56
alphabet key 99
arrangement 24, 63
assigning a clerk 30

B

backspace key 99
bill copy 24, 90
bottle link 62
bottle return 24, 62
bottom message 28, 95

C

cancel 21, 22, 24, 52
cash/amount tendered 21, 23, 43
change 32
character code 100
character code fixed key 99
character enter key 99
character fixed key 99
character keyboard 99
charge 21, 23
check 21, 23, 43
check endorsement 24
check print 24
check tracking 80
clearing a machine lock up 117
clerk button 17, 30
clerk interrupt 54
clerk key 30
clerk key/button/lock 16, 30
clerk lock 17, 30
clerk name 30, 95
clerk number 20, 22, 94
clerk read/reset report 103
clerk secret number key 17, 30
clerk transfer 24, 86
closing a check 82
commercial message 28, 95
commission rate 94
condiment 88
consecutive No. 28
correction 50
coupon 24, 59
coupon II (2) 24, 59
credit 21, 23, 43
cube 24
currency exchange 24, 64
customer display 18
customer number 24

D

daily sales read/reset report 104
daily sales reset report 53
date display 31
date set 12
declaration 24
department 21, 23, 32
deposit 24, 89
descriptor 95
discount (%-) 20, 22, 40
display 18
double size letter key 99
drawer 17

E

eat-in 24
EBT (electronic benefits transfer) 24, 75
editing character 101
entering characters 99
error code 114
error correction 21, 22, 50
Euro 21, 23, 44

F

financial read report 103
flat PLU 21, 22, 32
food stamp 66
food stamp shift 24, 66
food stamp subtotal 24, 66
food stamp tender 24, 66

G

group read/reset report 107
guest receipt 82

H

high amount limitation 34
hourly sales read/reset report 106

I

Illinois rule 69
indicator 19
individual clerk read/reset report 103
individual department, PLU/flat-PLU read report 102
ink ribbon 14, 118
item counter 19, 28

J

journal 10, 28, 119
journal skip 28

K

Ketten Bon 24
keyboard (TK-7000) 20
keyboard (TK-7500) 22

L

left cursor key 99
loan 20, 22, 49
logo message 28, 95

M

machine No. 28
main display 18
manual tax 24
media change 22, 49
menu shift 24
merchandise subtotal 24, 39
message 28, 95
minus 20, 22, 41
mixed tender 43
mode key 15
mode switch 16
money declaration 103, 105
monthly sales read/reset report 107
multiplication 21, 23, 33, 37
multiplication/for 21, 22, 33, 38

N

new balance 24, 81
new check 24, 80
new/old check 24, 80
no sale 20, 23, 24
non add 20, 23, 24
normal receipt 24
not found PLU 93
number of customers 77

O

OBR (optical barcode reader) 24
old check 24, 80
one touch NLU 24, 93
open 20, 22
open 2 (release compulsion) 25, 78
open check 25
open PLU 38
opening a check 81
operator number 25, 86
operator X/Z 25
option 120

P

paid out 21, 23, 48
paper feed 20, 22
periodic sales 108
pick up 20, 22, 49
PLU 36
PLU/flat-PLU read/reset report 106
plus 25
post receipt 20, 22
power failure 117
premium (%+) 25, 57
preparation 88
preset price 35
preset tax status 35
preset tender 61
previous balance 25
previous balance subtotal 25
previous item void 92
price 25, 38
price change 25
price inquiry 25
price reductions (red price) 87
price shift 25
printing slip 79
program end key 99

R

rate tax 25
read report 102
recall 25
receipt 11, 28, 120
receipt on/off 20, 22
receipt on/off switch / key 14
received on account 21, 23, 48
red price 25, 87
reduction 41
refund 20, 22, 47
remove/replace the sheet holder 26
repeat 19, 32, 37
reset report 53, 102
return 47
review 25, 85, 92
RF mode 47
right cursor key 99
roll paper 14

Index

S

scale 25
scanning PLU 93
second unit price 60
separate check 25, 85
set menu 63
shift key 99
sign off 30
sign on 30
single item 32, 37, 55
slip 79
slip back feed/release 25, 79
slip feed/release 25, 79
slip print 25, 79
space key 99
split sales of packaged item 33, 38
square 25
stamp ink 120
stock check 54
stock inquiry 25, 91
store 25
subtotal 21

T

table number 25, 81
table transfer 25, 86
takeout 25
tare 25
tax exempt 25
tax shift 20, 22, 39
taxable amount subtotal 25
taxable status 39
text print 25
text recall 25, 78
time display 31
time set 12
tip 25, 76
trainee status 94
tray total 25, 58

U

unit price inquiry 91
unit weight 25

V

validation 20, 22, 46
VAT 20, 22, 89
void 25

W

wetproof cover 15, 120



CASIO®

CASIO COMPUTER CO., LTD.
6-2, Hon-machi 1-chome
Shibuya-ku, Tokyo 151-8543, Japan

SA0002-A

TK-7000*E

Free Manuals Download Website

<http://myh66.com>

<http://usermanuals.us>

<http://www.somanuals.com>

<http://www.4manuals.cc>

<http://www.manual-lib.com>

<http://www.404manual.com>

<http://www.luxmanual.com>

<http://aubethermostatmanual.com>

Golf course search by state

<http://golfingnear.com>

Email search by domain

<http://emailbydomain.com>

Auto manuals search

<http://auto.somanuals.com>

TV manuals search

<http://tv.somanuals.com>