

# EXILIM

Digital Camera

## EX-S1/EX-M1

### User's Guide

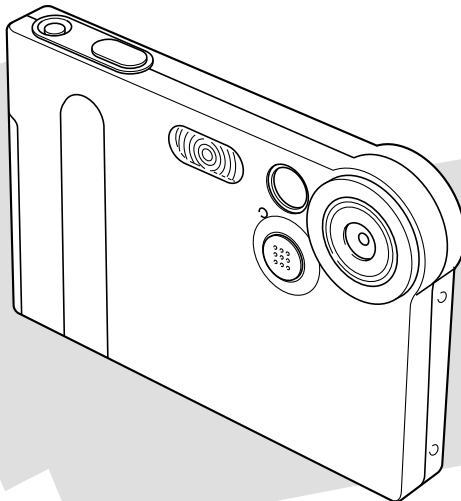

EX-M1

Thank you for purchasing this CASIO Product. Before using it, be sure to read the precautions contained in this User's Guide, and keep the User's Guide in a safe place for future reference.

All the illustrations in this manual show the EX-M1. See the text that accompanies the illustrations for information about how the EX-S1 and EX-M1 differ from each other.

# INTRODUCTION

## Unpacking

Check to make sure that all of the items shown below are included with your camera. If something is missing, contact your dealer as soon as possible.

Camera



EX-M1

Rechargeable lithium ion battery (NP-20)

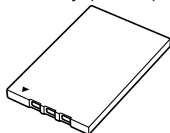

USB Cradle

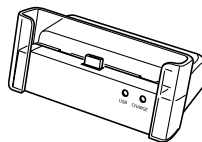

Special AC Adaptor

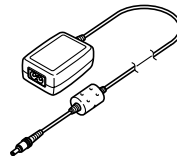

AC power cord \*

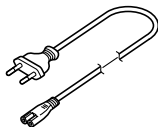

Strap

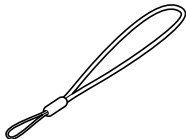

CD-ROM

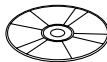

Special USB Cable

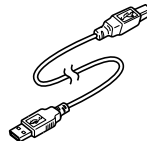

Dummy Card

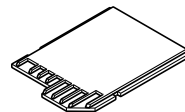

LCD Remote Controller

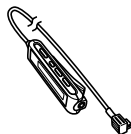

Stereo Headphones

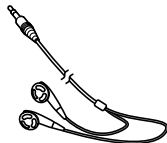

Basic Reference

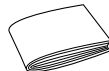

Rechargeable Lithium Ion Battery User's Guide



\* Comes with EX-M1 only

\* Comes with EX-M1 only

\* The shape of the AC power cord plug varies according to country or geographic area. The shape of the supplied AC power cord plug is shown on the package.

## Contents

**2 INTRODUCTION**

Unpacking .....	2
Features .....	8
Precautions .....	9
General Precautions	9
Data Error Precautions	11
Operating conditions	11
Condensation	12
LED Backlight	12
Lens	12
Other	12

**14 QUICK START GUIDE**

Getting Ready .....	14
To record an image .....	15
To view a recorded image .....	15
To delete an image .....	16

**17 GETTING READY**

General Guide .....	17
Camera	17
USB Cradle	18
Using the Controller .....	19
Monitor Screen Contents .....	20
Indicator Lamps .....	22
Attaching the Strap .....	22
Power Requirements .....	23
To load the battery	23
To charge the battery	24
Power Supply Precautions	28
Turning the Camera On and Off	29
Auto Power Off (APO)	29
Using the On-screen Menus .....	30
Configuring Display Language and Clock Settings ...	32

**34 BASIC IMAGE RECORDING**

Recording an Image .....	34
About the REC Mode Monitor Screen	35
Recording Precautions	35

## INTRODUCTION

Using Zoom .....	36
Using the Flash .....	37
Flash Precautions .....	38
Using the Self-timer .....	39
Specifying Image Size and Quality .....	40
To specify the image size .....	40
To specify the image quality .....	41

## 42 OTHER RECORDING FUNCTIONS

Exposure Compensation (EV Shift) .....	42
Adjusting the White Balance .....	43
Adjusting White Balance Manually .....	44
Using the Night Scene Mode .....	45
Using the Movie Mode .....	46
Recording Audio (EX-M1 Only) .....	47
Adding Audio to a Snapshot .....	47
Recording Your Voice .....	49
REC Mode Camera Settings .....	50
Turning the Monitor Screen On and Off .....	50
Assigning Functions to the Controller .....	51
Specifying Power On Default Settings .....	52

## 53 PLAYBACK

Basic Playback Operation .....	53
Playing an Audio Snapshot (EX-M1 Only) .....	54
Zooming the Displayed Image .....	55
Resizing an Image .....	56
Playing a Movie .....	57
Adding Audio to a Snapshot (EX-M1 Only) .....	58
To re-record audio .....	59
Playing Back a Voice Recording File (EX-M1 Only) ...	60

## 61 DELETING FILES

Deleting a Single File .....	61
Deleting All Files .....	62

## 63 FILE MANAGEMENT

Folders .....	63
Memory Folders and Files .....	63
Protecting Files .....	64
To protect a single file .....	64
To protect all files in memory .....	65

## INTRODUCTION

DPOF .....	65
To insert the date during printing .....	66
To configure print settings for a single image .....	66
To configure print settings for all images .....	67
PRINT Image Matching II .....	68
Exif Print .....	68
Using the FAVORITE Folder .....	69
To copy a file to the FAVORITE folder .....	69
To display a file in the FAVORITE folder .....	70
To delete a file from the FAVORITE folder .....	70

## 71 OTHER SETTINGS

Turning the Key Tone On and Off .....	71
Specifying an Image for the Startup Screen .....	71
Changing the Date and Time Setting .....	72
Changing the Date Format .....	72
Changing the Display Language .....	73
Formatting Built-in Memory .....	73

## 74 USING A MEMORY CARD

Using a Memory Card .....	75
To insert a memory card into the camera .....	75
To remove a memory card from the camera .....	75
Formatting a Memory Card .....	76
Memory Card Precautions .....	77
Copying Files .....	77
To copy all the files in built-in memory to a memory card .....	77
To copy a file from a memory card to built-in memory .....	78

## 79 USING THE CAMERA WITH A COMPUTER

Installing the Software on the CD-ROM .....	79
About the bundled CD-ROM .....	79
Operating environment .....	80
Installing the software .....	81
Transferring Files to a Computer .....	87
Transferring Files Over a USB Connection .....	87
Using a Memory Card to Transfer Images to a Computer .....	90
Memory Data .....	91
Memory Directory Structure .....	92
Image Files Supported by the Camera .....	93
Built-in Memory and Memory Card Precautions .....	93

### 94 PLAYING AN AUDIO FILE (EX-M1 Only)

Transferring Audio Files to the Camera .....	94
Preparing the Camera for Audio Player Operation ...	95
Using the Camera as an Audio Player .....	96
General Guide .....	96
Basic Remote Controller Operations .....	98
Specifying the Audio Playback Mode .....	99
Selecting a Specify Track for Playback .....	99
Specifying the Track Playback Sequence .....	100
Disabling Remote Controller Button Operations .....	102
LCD Remote Control Error Messages .....	103
Audio Playback Precautions .....	103

### 104 APPENDIX

Menu Reference .....	104
Indicator Lamp Reference .....	105
Camera Indicator Lamps .....	105
USB Cradle Indicator Lamps .....	107
Troubleshooting Guide .....	108
Display Messages .....	111
Specifications .....	112
Main Specifications .....	112

### ►► IMPORTANT! ►►

- The contents of this manual are subject to change without notice.
- CASIO COMPUTER CO., LTD. assumes no responsibility for any damage or loss resulting from the use of this manual.
- CASIO COMPUTER CO., LTD. assumes no responsibility for any loss or claims by third parties which may arise through the use of the EX-S1/EX-M1.
- CASIO COMPUTER CO., LTD. shall not be held liable for any damages or losses suffered by you or any third party due to the use of Photo Loader and/or Photohands.
- CASIO COMPUTER CO., LTD. assumes no responsibility for any damage or loss caused by deletion of data as a result of malfunction, repairs, or battery replacement. Be sure to back up all important data on other media to protect against its loss.
- *The SD logo is a registered trademark.*
- *Windows, Internet Explorer, and DirectX are registered trademarks of Microsoft Corporation.*
- *Macintosh is a registered trademark of Apple Computer, Inc.*
- *MultiMediaCard is a trademark of Infineon Technologies AG of Germany, and licensed to the MultiMediaCard Association (MMCA).*
- *Acrobat and Acrobat Reader are trademarks of Adobe Systems Incorporated.*

- *The USB driver (mass storage) uses Phoenix Technologies Ltd. software.  
Compatibility Software Copyright © 1997  
Phoenix Technologies Ltd., All Rights Reserved.*
- *MPEG Layer-3 audio decoding technology licensed from Fraunhofer IIS and Thomson multimedia.*
- *Other company, product and service names used herein may also be trademarks or service marks of others.*
- *Photo Loader and Photohands are the property of CASIO COMPUTER CO., LTD. Except as stipulated above, all copyrights and other related rights to these applications revert to CASIO COMPUTER CO., LTD.*

### ■ Copyright Restrictions

Except for the purposes of your own personal enjoyment, unauthorized copying of snapshot files, movie files, audio files, and music files violates copyright laws and international contracts. Distribution to third parties of such files over the Internet without permission of the copyright holder, whether for profit or for free, violates copyright laws and international contracts.

### Features

- **1.24 million Effective Pixels**  
The 1.24-megapixel CCD (1.34 million total pixels) not only provides plenty of resolution for normal image recording, it also creates images that are perfectly suited for editing and manipulation on a PC. An interpolation process can be used to store 1,600 x 1,200-pixel images that are equivalent to those produced by a 2-megapixel camera.
- **Fixed focus lens for quick operation**  
Fixed focus eliminates the need for lens movement, which shortens startup time and shooting time.
- **1.6-inch TFT color LCD monitor screen**
- **4X digital zoom**
- **12MB flash memory**  
Images can be recorded without using a memory card.
- **Support for SD memory cards and MMC (MultiMedia Cards) for memory expansion**
- **Easy Charging**  
Just place the camera onto the USB cradle to charge its battery.
- **Easy Image Transfer**  
Transfer images to a computer simply by placing the camera onto the USB cradle.
- **DCF Data Storage**  
DCF (Design rule for Camera File system) data storage protocol provides image inter-compatibility between the digital camera and printers.
- **Digital Print Order Format (DPOF)**  
Images can be printed easily in the sequence you want using a DPOF compatible printer. DPOF can also be used when specifying images and quantities for printing by professional print services.
- **PRINT Image Matching II Compatible**  
Images include PRINT Image Matching II data (mode setting and other camera setup information). A printer that supports PRINT Image Matching II reads this data and adjusts the printed image accordingly, so your images come out just the way you intended when you recorded them.
- **Bundled with Photo Loader and Photohands**  
Your camera comes bundled with the latest version of Photo Loader, the popular application that automatically loads images from your camera to your PC. Photo Loader also includes a feature that automatically attaches images to e-mail messages. Also included is Photohands, an application that makes image retouching quick and easy.



## INTRODUCTION

### \* EX-M1 Only

- Snapshot + Audio Mode  
Adds audio to a snapshot.
- Movie + Audio Mode
- Voice Recording  
Quick and easy recording of voice input.
- After Recording  
Adds audio to images after they are recorded.
- Audio Player Capabilities  
Use the camera to play back music data from standard MP3 (MPEG-1 Audio Layer-3) files.

## Precautions

### General Precautions

Be sure to observe the following important precautions whenever using the EX-S1/EX-M1.

All references in this manual to “this camera” and “the camera” refer to the CASIO EX-S1/EX-M1 Digital Camera.

- Never try to take pictures or use the built-in display while operating a motor vehicle or while walking. Doing so creates the danger of serious accident.
- Never try to open the case of the camera or attempt your own repairs. High-voltage internal components create the risk of electric shock when exposed. Always leave maintenance and repair work up to CASIO authorized service providers.
- Never look at the sun or any other bright light through the camera’s viewfinder. Doing so can damage your eyesight.
- Keep the connector cover and the other small parts and accessories of this camera out of the reach of small children. If swallowed accidentally, contact your physician immediately.
- Never fire the flash in the direction of a person operating a motor vehicle. Doing so can interfere with the driver’s vision and create the danger of accident.

## INTRODUCTION

- Never fire the flash while it is too close to the subject's eyes. Intense light from the flash can cause eye damage if it is fired too close to the eyes, especially with young children. When using the flash, the camera should be at least one meter from the eyes of the subject.
- Keep the camera away from water and other liquids, and never let it get wet. Moisture creates the danger of fire and electric shock. Never use the camera outdoors in the rain or snow, at the seashore or beach, in the bathroom, etc.
- Should foreign matter or water ever get into the camera, immediately turn power off, unplug the AC adaptor from the power outlet, and contact your dealer or nearest CASIO authorized service provider. Using the camera under these conditions creates the danger of fire and electric shock.
- Should you ever notice smoke or a strange odor coming out of the camera, immediately turn power off and unplug the AC adaptor from the power outlet. Using the camera under these conditions creates the danger of fire and electric shock. After making sure there is no more smoke coming from the camera, take it to your nearest CASIO authorized service provider for repair. Never attempt your own maintenance.
- Never use the AC adaptor to power any other device besides this camera. Never use any other AC adaptor besides the one that comes with this camera.
- Never cover the AC adaptor with a quilt, blanket, or other cover while it is in use, and do not use it near a heater.
- At least once a year, unplug the AC adaptor from the power outlet and clean the area around the prongs of the plug. Dust build up around the prongs can create the danger of fire.
- If the camera's case should ever become cracked due to dropping it or otherwise subjecting it to rough treatment, immediately turn power off, unplug the AC adaptor from the power outlet, and contact your nearest CASIO authorized service provider.
- Never use the camera inside of an aircraft or in any other areas where its use is prohibited. Doing so can result in an accident.
- Physical damage and malfunction of this camera can cause the data stored in its memory to be deleted. Be sure to always keep backup copies of data by transferring them to personal computer memory.
- Never open the battery cover, disconnect the AC adaptor from the camera or unplug it from the wall socket while recording images. Doing so will not only make storage of the current image impossible, it can also corrupt other image data already stored in camera memory.

### Data Error Precautions

- Your digital camera is manufactured using precision digital components. Any of the following creates the risk of corruption of data in camera memory.
  - Removing the battery while image recording or data communication is in progress.
  - Removing a memory card while image recording is in progress.
  - Removing the battery, removing the memory card, or placing the camera onto the USB cradle while the operation/flash charge lamp is still flashing after you turn off the camera.
  - Disconnecting the USB cable, removing the camera from the USB cradle, or disconnecting the AC adaptor from the USB cradle while a data communication operation is being performed.
  - Using low battery.
  - Other abnormal operations.

Any of the above conditions can cause an error message to appear on the monitor screen (page 111). Follow the instructions provided by the message to correct the situation.

### Operating conditions

- This camera is designed for use in temperatures ranging from 0°C to 40°C.
- Do not use or keep the camera in the following areas.
  - In areas subject to direct sunlight
  - In areas subject to high humidity or dust
  - Near air conditioners, heaters, or other areas subject to temperature extremes
  - Inside of a closed vehicle, especially one parked in the sun
  - In areas subject to strong vibration

### Condensation

- When you bring the camera indoors on a cold day or otherwise expose it to a sudden change of temperature, there is the possibility that condensation can form on the exterior or on interior components. Condensation can cause malfunction of the camera, so you should avoid exposing it to conditions that might cause condensation.
- To keep condensation from forming, place the camera into a plastic bag before moving it into a location that is much warmer or colder than your current location. Leave it in the plastic bag until the air inside the bag has a chance to reach the same temperature as the new location. If condensation does form, remove the battery from the camera and leave the battery cover open for a few hours.

### LED Backlight

- The monitor screen is illuminated by an LED backlight. A dark monitor screen indicates that the LED backlight has reached the end of its service life, and needs to be replaced by a CASIO authorized service provider. Note that you will be charged for LED backlight replacement. The LED backlight brightness is reduced by half after about 1,000 hours of use.

### Lens

- Never apply too much force when cleaning the surface of the lens. Doing so can scratch the lens surface and cause malfunction.
- Fingerprints, dust, or any other soiling of the lens can interfere with proper image recording. Never touch the lens with your fingers. You can remove dust particles from the lens surface by using a lens blower to blow them off. Next, wipe the surface of the lens with a soft lens cloth.

### Other

- The camera may become slightly warm during use. This does not indicate malfunction.

## INTRODUCTION

### **GUIDELINES LAID DOWN BY FCC RULES FOR USE OF THIS UNIT IN THE U.S.A. (not applicable to other areas).**

This device complies with Part 15 of the FCC Rules. Operation is subject to the following two conditions: (1) this device may not cause harmful interference, and (2) this device must accept any interference received, including interference that may cause undesired operation.

#### **NOTICE**

This equipment has been tested and found to comply with the limits for a Class B peripheral, pursuant to Part 15 of the FCC Rules. These limits are designed to provide reasonable protection against harmful interference in a residential installation. This equipment generates, uses and can radiate radio frequency energy and, if not installed and used in accordance with the instructions, may cause harmful interference to radio communications. However, there is no guarantee that interference will not occur in a particular installation. If this equipment does cause harmful interference to radio or television reception, which can be determined by turning the equipment off and on, the user is encouraged to try to correct the interference by one or more of the following measures:

- Reorient or relocate the receiving antenna.
- Increase the separation between the equipment and receiver.
- Connect the equipment into an outlet on a circuit different from that to which the receiver is connected.
- Consult the dealer or an experienced radio/TV technician for help.

#### **FCC WARNING**

Changes or modifications not expressly approved by the party responsible for compliance could void the user's authority to operate the equipment.

### **Declaration of Conformity**

Model Number: EX-S1/EX-M1  
Trade Name: CASIO COMPUTER CO.,LTD.  
Responsible party: CASIO INC.  
Address: 570 MT. PLEASANT AVENUE,  
DOVER,NEW JERSEY 07801  
Telephone number: 973-361-5400

This device complies with Part 15 of the FCC Rules.  
Operation is subject to the following two conditions:  
(1) This device may not cause harmful interference, and  
(2) this device must accept any interference received, including interference that may cause undesired operation.

CASIO COMPUTER CO.,LTD. EX-S1/EX-M1



Tested To Comply  
With FCC Standards

FOR HOME OR OFFICE USE

# QUICK START GUIDE

## Getting Ready

### 1. Load the battery (page 23).

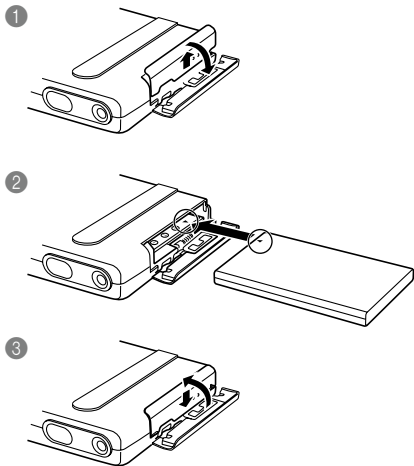

### 2. Place the camera onto the USB cradle to charge the battery (page 24).

- It takes about two hours to achieve a full charge.

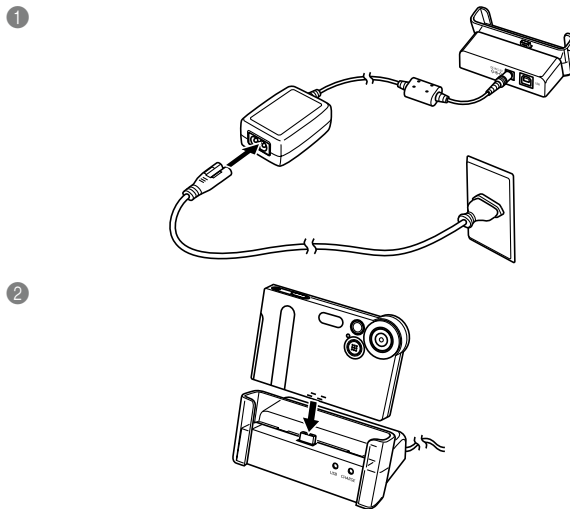

### 3. Configure screen message language, and current time settings (page 32).

### To record an image

(See page 34 for details.)

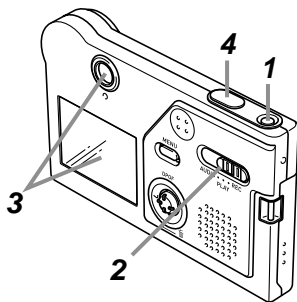

- 1. Press the power button to turn on the camera.**
- 2. Align the mode selector with “REC”.**
- 3. Point the camera at the subject, and use the monitor screen or viewfinder to compose the image.**
- 4. Holding the camera still, gently press the shutter release button.**

### To view a recorded image

(See page 53 for details.)

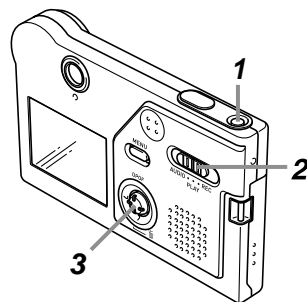

- 1. Press the power button to turn on the camera.**
- 2. Align the mode selector with “PLAY”.**
- 3. Rock the controller left (back) or right (forward) to scroll through images on the monitor screen.**

## To delete an image

(See page 61 for details.)

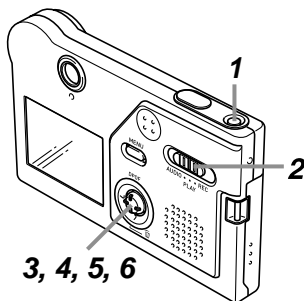

- 1. Press the power button to turn on the camera.**
- 2. Align the mode selector with “PLAY”.**
- 3. Rock the controller down to select .**
- 4. Rock the controller left or right to scroll through images and display the one you want to delete.**
- 5. Rock the controller up or down to select “Delete”.**
  - To exit the image delete operation without deleting anything, select “Cancel”.
- 6. Click by pressing straight down on the controller to delete the selected image.**



# GETTING READY

This section contains about things you need to know about and do before trying to use the camera.

## General Guide

The following illustrations show the names of each component, button, and switch on the camera.

## Camera

### ■ Front

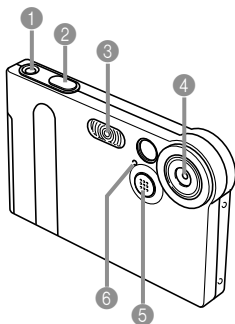

- 1 Power button
- 2 Shutter release button
- 3 Flash
- 4 Lens
- 5 Microphone (EX-M1 only)
- 6 Self-timer lamp

### ■ Back

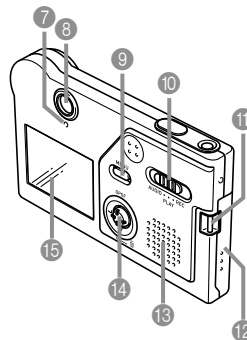

- 7 Operation/Flash charge lamp
- 8 Viewfinder
- 9 MENU button
- 10 Mode selector
- 11 Strap bar
- 12 Battery cover
- 13 Speaker (EX-M1 only)
- 14 Controller

\* Rock the controller up, down, left, or right to select items. To execute a function, click by pressing straight down on the controller.

- 15 Monitor Screen

## GETTING READY

### Bottom

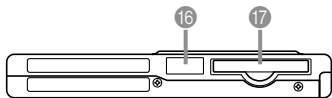

- 16 Connector cover
- 17 Memory card slot

If you are not using a memory card, be sure to insert the dummy card into this slot to protect against dust and damage.

#### Removing the Connector Cover

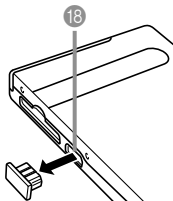

Be sure to replace the connector cover whenever the connector is not being used.

- 18 Connector
  - \* Connection of an LCD remote controller is supported by the EX-M1 only.

### USB Cradle

Simply placing your CASIO digital camera onto the USB cradle lets you perform the following tasks.

- Battery charging (page 24)
- Automatic transfer of images to a computer (page 87)

### Front

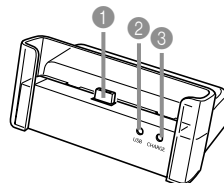

- 1 Camera connector
- 2 USB lamp
- 3 CHARGE lamp

### Back

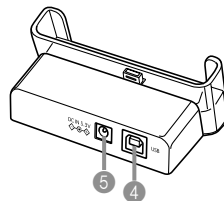

- 4 USB (USB port)
- 5 DC IN 5.3V (AC adaptor connector)

### NOTE

- See “Using the Camera as an Audio Player” on page 96 for information about the LCD remote controller that comes with the EX-M1.

## Using the Controller

The controller is used to select on-screen items and to execute functions. The following are the terms used in this manual to describe controller operations.

Term	Meaning
Rock	Use your thumb to push the controller up, down, left, or right.
Click	Use your thumb to press straight down on the controller until it clicks.

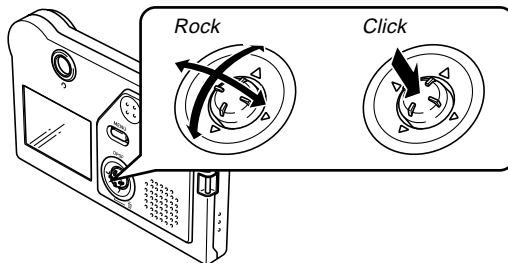

- While a menu is on the display, rock the controller to select a tab or menu item. When the item you want is selected, click to execute or apply it.

## Monitor Screen Contents

The monitor screen uses various indicators and icons to keep you informed of the camera's status.

### REC Mode

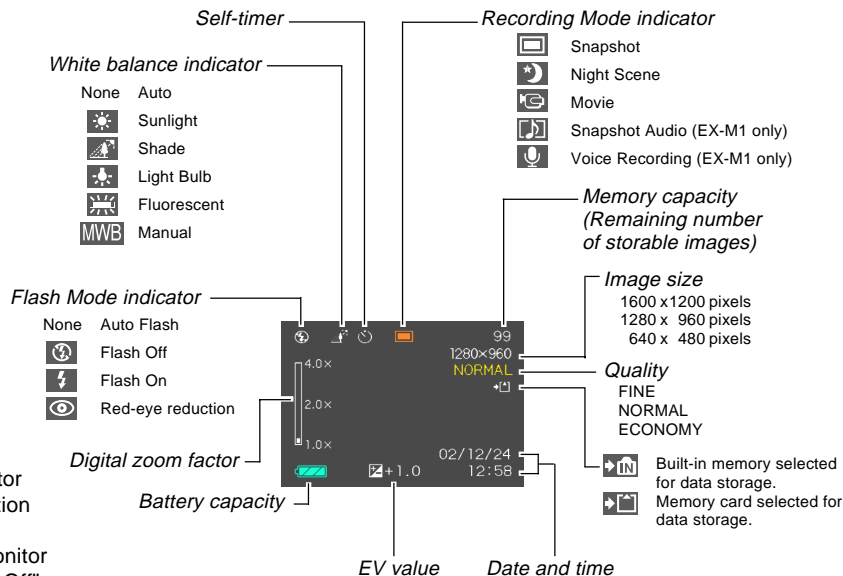

### NOTE

- You can turn display of monitor screen information on and off. See "Turning the Monitor Screen On and Off" on page 50 for more information.

■ **PLAY Mode**

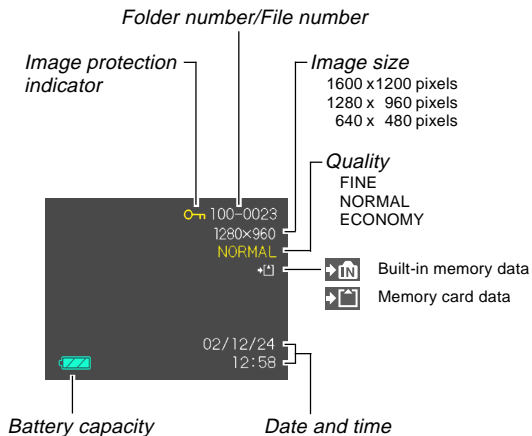

▶▶ **IMPORTANT!** ◀◀

- Some information may not display properly if you display an image that was recorded using a different digital camera model.

## GETTING READY

### Indicator Lamps

You can find out the operational status of the camera and the USB cradle at a glance by checking the color of the indicator lamps, and whether a lamp is lit or flashing. For details, see "Indicator Lamp Reference" on page 105.

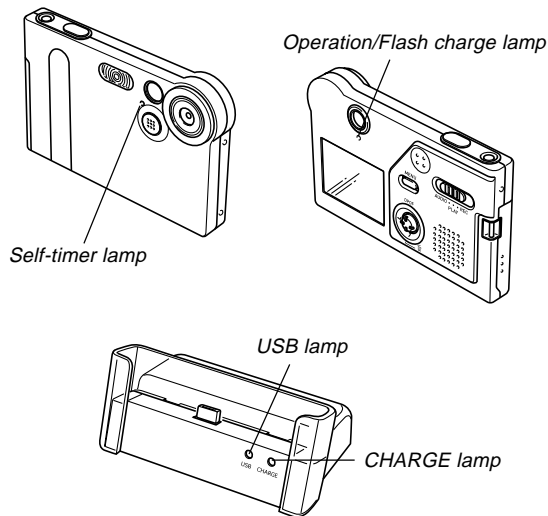

### Attaching the Strap

Attach the strap to the strap bar as shown in the illustration.

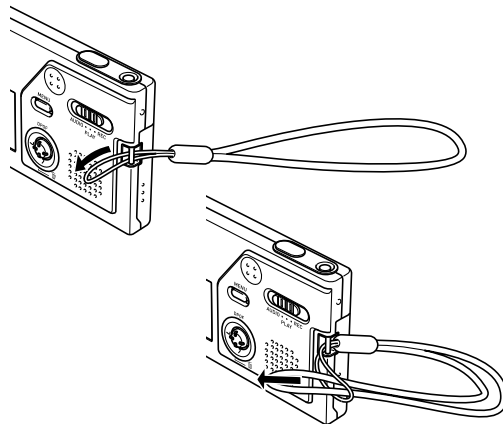

### ►► IMPORTANT! ◀◀

- Be sure to keep the strap around your wrist when using the camera to protect against accidentally dropping it.
- The supplied strap is intended for use with this camera only. Do not use it for any other purpose.
- Never swing the camera around by the strap.

## Power Requirements

Your camera is powered by a rechargeable lithium ion battery (NP-20).

### To load the battery

1. Pressing the battery cover on the side of the camera, slide it in the direction indicated by the arrow and then swing it open.

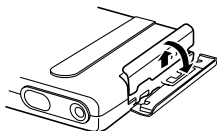

2. Align the arrow mark on the battery with the arrow mark on the camera as shown in the illustration, and slide the battery into the battery compartment.

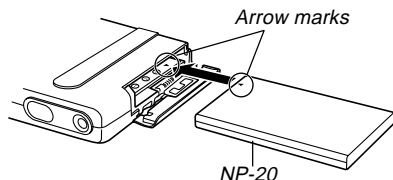

3. Swing the battery cover closed, and then slide it in the direction indicated by the arrow while pressing down on it.

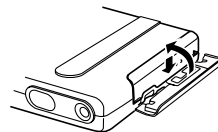

#### IMPORTANT!

- Use only the special NP-20 rechargeable lithium ion battery to power this camera. Use of any other type of battery is not supported.

#### NOTE

- When removing the battery, open the battery cover and tilt it towards the side. When the battery slides out part way, pull it out by hand.

The battery is not charged when you purchase the camera. You need to charge the battery before using the camera for the first time.

## To charge the battery

1. Connect the AC power cord to the AC adaptor.
2. Plug the other end of the AC power cord into a household power outlet.
3. Connect the AC adaptor to the DC IN 5.3V connector of the USB cradle.

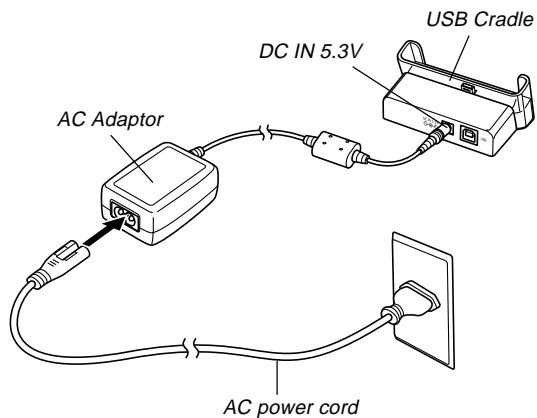

4. Turn off the camera and remove its connector cover.

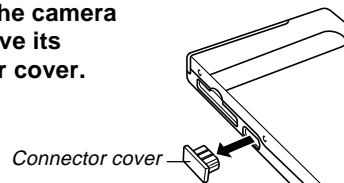

5. Set the camera onto the USB cradle.

- The CHARGE lamp on the USB cradle should turn red, indicating that charging has started. When charging is complete, the CHARGE lamp will turn green.

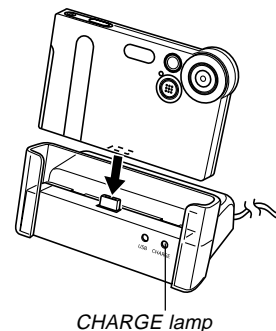

6. After charging is complete, remove the camera from the USB cradle and replace the connector cover.



### »» IMPORTANT! ««

- It takes about two hours to achieve a full charge. Actual charging time depends on current battery capacity and charging conditions.
- Use only the USB cradle to charge the special NP-20 rechargeable lithium ion battery. Never use any other charger device.
- Use only the bundled AC adaptor. Never use any other type of AC adaptor. Do not use optionally available AD-C620 and AD-C630 AC adaptors with this camera.
- Make sure that the camera connector of the USB cradle is securely inserted into the camera's connector as far as it will go.
- The CHARGE lamp may remain amber colored and the charge operation may not start right away if you try to charge immediately after using the camera (which causes battery to become warm) or when it is too hot or too cold where you are performing the charge operation. If this happens, simply wait until the battery reaches normal temperature. The CHARGE lamp will turn red and charging will start when the battery temperature returns to the allowable charging temperature range.

- The CHARGE lamp flashing red indicates that an error occurred while charging. An error can be caused by any of the following: a problem with the cradle, a problem with the camera, or a problem with the battery or how it is loaded. Remove the camera from the cradle and see if it works normally.
- The USB cradle can be used for charging or USB data communication only.

### »» NOTE ««

- USB cradle is designed for operation with any power supply in the range of 100V to 240V AC. Note, however, that the shape of the AC power cord plug varies according to country or geographic area. If you plan to use the cradle in another geographic area, you need to purchase a commercially available AC power cord that is compatible with the power outlets in that area.

### ■ If the camera works normally

1. Continue using the camera until the current charge is used up, and then charge the battery.

### ■ If the camera does not work normally

This can mean there is a problem with how the battery is loaded.

1. Remove the battery from the camera and check the battery contacts for dirt. If the contacts are dirty, wipe them clean with a dry cloth.
2. Check to make sure that the AC adaptor's power cord is connected securely to the power outlet and cradle.
  - If the same symptoms occur again when you place the camera on the cradle after taking the above steps, contact a CASIO authorized service provider.

### ■ Battery Life Guidelines

The battery life guideline values given below indicate the amount of time at standard temperature (25°C) until power automatically turns off due to battery failure. They do not guarantee that the battery will provide the amount of service indicated. Low temperatures and continued use reduce battery life.

Operation	Approximate Battery Life
Continuous Recording	80 minutes (480 shots)
Continuous Playback (Continuous Snapshot Recording)	110 minutes
Continuous Voice Recording*	80 minutes
Continuous Audio Playback*	330 minutes

\* EX-M1 only

#### Measurement Conditions

Figures are based on continuous recording under the following conditions.

Flash turned off

Normal temperature (25°C)

- Recording one image per minute under the above conditions reduces battery life to about one sixth of that noted above.
- Voice recording times are based on continuous recording, while audio playback times are based on continuous output (through headphones).

## GETTING READY

- The above values are based a new battery starting from a full charge. Repeated charging shortens battery life.
- Battery life is greatly affected by how much you use flash, zoom and other functions, and how long you leave power turned on.



\* Voice recording and audio playback times apply to the EX-M1 only.

### ■ Tip to Make the Battery Last Longer

If you do not need the flash while recording, use the menu to select  (flash off) for the flash mode. See page 37 for more information.

### ■ Low Battery Indicator

The following shows how the battery capacity indicator on the monitor screen changes as battery power is used. If you continue to use the camera while the battery level is , camera power will automatically turn off. When this happens, charge the battery as soon as possible.

Battery Level	High ←————→ Low
Indicator	 →  → 

## Power Supply Precautions

### ■ Battery Precautions

See the instructions that come with the rechargeable lithium ion battery for important precautions you need to observe during its use.

### ■ USB Cradle and AC Adaptor Precautions



Caution!

- Never use an electrical outlet whose voltage is outside the rating marked on the AC adaptor. Doing so can create the danger of fire or electric shock. Use only the bundled AC adaptor specified for this camera.
- Do not allow the AC adaptor cord to become cut or damaged, do not place heavy objects on it, and keep it away from heat. A damaged power cord creates the risk of fire and electric shock.
- Never try to modify the AC adaptor cord, or subject it to severe bending, twisting, or pulling. Doing so creates the risk of fire and electric shock.
- Never touch the AC adaptor while your hands are wet. Doing so creates the risk of electric shock.

- Do not overload extension cords or wall outlets. Doing so creates the danger of fire and electric shock.
- Should the cord of the AC adaptor become damaged (exposed internal wiring), request a replacement from a CASIO authorized service provider. A damaged AC adaptor cord creates the danger of fire or electric shock.

- Make sure you always remove the camera from the USB cradle before connecting or disconnecting the AC adaptor.
- Charging and USB data communication can cause the AC adaptor to become warm. This is normal and does not indicate malfunction.
- Unplug the AC power cord from the power outlet whenever you are not using it.

## Turning the Camera On and Off

Press the power button to turn the camera on and off.

Pressing the power button to turn on the camera causes the operation/flash charge lamp to flash green. Press the power button again to turn off the camera.

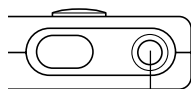

Power button

### ►► IMPORTANT! ◀◀

- If camera power is turned off by the Auto Power Off feature, press the power button to turn it back on again.

## Auto Power Off (APO)

Auto Power Off (APO) automatically turns off the camera when you do not perform any operation for certain amount of time. The amount of time that needs to pass before APO is triggered depends on the mode the camera is in.

Mode	Approximate Time to APO
REC	2 minutes
PLAY	2 minutes
AUDIO (EX-M1 only)	10 seconds

## Using the On-screen Menus

Pressing MENU displays menus on the monitor screen that you can use to perform various operations. The menu that appears depends on whether you are in the REC mode or the PLAY mode. The following shows an example menu procedure in the REC mode.

### 1. Turn on the camera, and then align the mode selector with "REC" to enter the REC mode.

- If you want to enter the PLAY mode instead, you would align the mode selector with "PLAY".

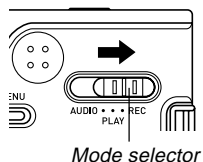

### 2. Press MENU.

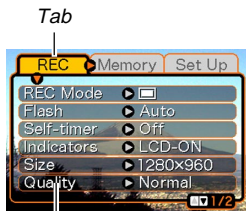

#### Settings

Selection cursor (indicates the currently selected item)

## ● Menu Screen Operations

When you want to do this:	Do this:
Move between tabs	Rock the controller left or right
Move from the tab to the settings	Rock the controller down
Move between the settings	Rock the controller up or down
Display the options available for a setting	Rock the controller right or click the controller
Select an option	Rock the controller up or down
Register an option selection and exit the menu screen	Click the controller
Register an option selection and return to the menu screen	Rock the controller left
Exit the menu screen	Press MENU

**3. Rock the controller left or right to select the tab you want, and then rock it down to move the selection cursor from the tab to the settings.**

- If you ever need to move the selection cursor back from the settings to the tabs, rock the controller up until the cursor reaches the top of the menu.

**4. Rock the controller up or down to select the setting you want to change, and then rock the controller to the right.**



*Example: "Flash" setting selected.*

- This displays a submenu of options available for the selected setting.
- Instead of rocking the controller, you could also click it.

**5. Rock the controller up or down to select the option you want, and then click.**

**6. Next, do either of the following.**

If you want to do this:	Do this:
Apply the setting and exit the menu screen	Click the controller.
Apply the setting and return to menu screen to change other settings	Rock the controller left.

- See "Menu Reference" on page 104 for more information about menus.

### Configuring Display Language and Clock Settings

Be sure to configure the following settings before using the camera to record images.

- Display language
- Date and time

Note that the current date and time settings are used by the camera to generate the date and time that are stored along with image data, etc.

### ▶▶ IMPORTANT! ◀◀

- The camera's clock settings are cleared whenever power is totally cut off. This can happen if the battery goes dead while the camera is not being supplied power by the USB cradle. The clock setting screen will appear automatically the next time you turn on power after the settings are cleared. Set the date and time before using the camera.
- The current date and time settings will be cleared if the battery remains dead without being charged for about one day.
- Recording images without configuring the clock settings causes incorrect time information to be registered. Be sure to configure the clock settings before using the camera.



## GETTING READY

1. Press the power button to turn on the camera.
2. Rock the controller up or down to select the language you want.  
日本語 : Japanese  
English : English  
Français : French  
Deutsch : German  
Español : Spanish  
Italiano : Italian
3. Click to register the language setting and advance to the clock settings.



4. Set the date and the time.



To do this:	Do this:
Move the cursor between settings	Rock the controller left or right.
Change the setting at the current cursor location	Rock the controller up or down.

5. Click to register the clock settings and exit the setting screen.

# BASIC IMAGE RECORDING

This section describes the basic procedure for recording an image.

## Recording an Image

Your camera automatically adjusts shutter speed in accordance with the brightness of the subject. Images you record are stored in the camera's flash memory.

- You can also use optionally available SD memory cards and MultiMedia Cards (MMC) to store images (page 74).

### 1. Press the power button to turn on the camera.

- This causes an image or a message to appear on the monitor screen.

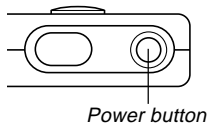

### 2. Align the mode selector with "REC".

- This enters the REC mode for image recording.

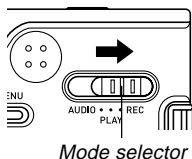

### 3. Compose the image on the monitor screen.

- The focusing range of the camera is approximately 1 meter to infinity ( $\infty$ ).
- When performing this step, take care so your fingers do not block the lens or any of the sensors.
- You can compose images using either the monitor screen or the optical viewfinder.
- When using the optical viewfinder, you can turn off the monitor screen to save power (page 50).

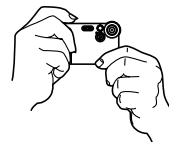
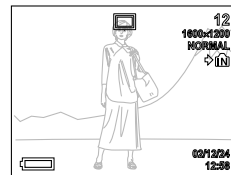

### 4. Press the shutter release button to record the image.

- The number of images that can be stored in memory depends on the resolution setting you are using (page 40).

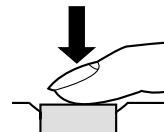

- Depending on the distance or angle between the subject and the camera, the image you see in the viewfinder may not be exactly the image that is recorded.
- Press the shutter release gently to avoid camera movement.

### About the REC Mode Monitor Screen

- The image shown on the monitor screen in the REC mode is a simplified image for composing purposes. The actual image is recorded in accordance with the image quality setting currently selected on your camera. The image saved on memory has much better resolution and detail than the REC mode monitor screen image.
- Certain levels of subject brightness can cause the response of the REC mode monitor screen to slow down, which causes some static noise in the monitor screen image.

### Recording Precautions

- Never open the battery cover or place the camera onto the USB cradle while the operation/flash charge lamp is flashing green. Doing so not only causes the current image to be lost, it can also corrupt images already stored in camera memory and even lead to malfunction of the camera.
- Never remove the memory card while an image is being recorded to the memory card.
- Fluorescent lighting actually flickers at a frequency that cannot be detected by the human eye. When using the camera indoors under such lighting, you may experience some brightness or color problems with recorded images.
- The camera automatically adjusts its sensitivity in accordance with the brightness of the subject. This can cause some static noise to appear in images of relatively dark subjects.
- For a dimly lit subject, the camera raises the sensitivity and uses a faster shutter speed. Because of this, you need to guard against camera movement if you have flash turned off (page 37) when recording a dimly lit subject.
- If unwanted light is shining on the lens, shade the lens with your hand when recording the image.

### Using Zoom

You can use the digital zoom feature of your camera to zoom in on the center of an image. Performing a zoom operation toggles the zoom factor between 1X and 4X.

1. In the REC mode, press **MENU**.
2. Rock the controller left or right to select the “REC” tab.
3. Rock the controller up or down to select “Digital Zoom”, and then rock the controller to the right.
4. Rock the controller up or down to select “On”, and then click.
  - Selecting “Off” in step 4 disables digital zoom.

### 5. Rock the controller up or down in the REC mode to change the digital zoom factor.

Rock up to zoom in.

Rock down to zoom out.

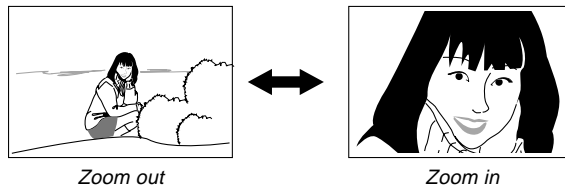

### 6. Record the image.

#### ►► IMPORTANT! ◀◀

- Zoom is disabled whenever the monitor screen is turned off (page 50).
- To disable digital zoom, select “Off” for the “Digital Zoom” setting on the “REC” tab.

### Using the Flash

Perform the following steps to select the flash mode you want to use.

1. In the REC mode, press MENU.
2. Rock the controller left or right to select the "REC" tab.
3. Rock the controller up or down to select "Flash", and then rock the controller to the right.
4. Rock the controller up or down to select the flash mode you want, and then click.



To do this:	Select this setting:
Have the flash fire automatically when required (Auto Flash)	Auto
Turn off the flash (Flash Off)	
Always fire the flash (Flash On)	
Fire a pre-flash followed by image recording with flash, reducing the chance of red-eye in the image (Red-eye reduction)	

### 5. Record the image.

#### ►► IMPORTANT! ◀◀

- The flash unit of this camera fires a number of times when you record an image. The initial flashes are pre-flashes, which the camera uses to obtain information it uses for exposure settings. The final flash is for recording. Make sure that you keep the camera still until the shutter releases.
- Image recording may not be performed if you press the shutter release button while the operation/flash charge lamp is flashing amber.

### »» NOTE ««

- You can use the key customization feature (page 51) to configure the camera so the flash mode changes whenever you rock the controller left or right while in the REC mode.

### ■ About Red-eye Reduction

Using the flash to record at night or in a dimly lit room can cause red spots inside the eyes of people who are in the image. This is caused when the light from the flash reflects off of the retina of the eye. Red-eye reduction fires a pre-flash, which causes the irises in the eyes of any people in the image to close. This is followed by another flash operation when the image is actually recorded.

### »» IMPORTANT! ««



Note the following important points when using red-eye reduction.

- Red-eye reduction does not work unless the people in the image are looking directly at the camera (flash). Before pressing the shutter release button, call out to the subjects so they all look at the camera.
- Red-eye reduction may not work very well if the subjects are located far away from the camera.

### Flash Precautions

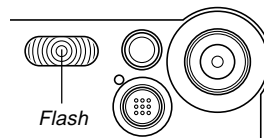
- Take care that your fingers do not block the flash when you hold the camera. Covering the flash with your finger can greatly reduce its effectiveness.



- The approximate effective range of the flash is shown below. The flash is unable to adequately illuminate a subject that is outside this range.  
1 meter to 2 meters
- The flash takes anywhere from a few seconds as long as 10 seconds to attain full charge after being fired. The actual time required depends on the battery level, temperature, and other conditions.
- The flash does not fire during movie recording. This is indicated by  on the monitor screen.
- The flash unit may not be able to charge when battery power is low. Low battery power is indicated by the  on the monitor screen, and when the flash fails to fire properly resulting in poor image exposure. When these symptoms occur, charge the camera's battery as soon as possible.

## BASIC IMAGE RECORDING

- When the red-eye reduction mode (👁) is being used, flash intensity is adjusted automatically in accordance with the exposure. The flash may not fire at all when the subject is brightly lit.
- White balance is fixed while the flash is being used, so sunlight, fluorescent lighting, or other sources of illumination in the immediate area may affect the coloring of the recorded image.

### Using the Self-timer

The self-timer delays shutter release so it is performed about 10 seconds after you press the shutter release button.

- 1. In the REC mode, press MENU.**
- 2. Rock the controller left or right to select the “REC” tab.**
- 3. Rock the controller up or down to select “Self-timer”, and then rock the controller to the right.**
- 4. Rock the controller up or down to select “10 sec”, and then click.**
  - Selecting “Off” in step 4 disables the self-timer.

### 5. Record the image.

- The self-timer lamp flashes and the shutter releases about 10 seconds after you press the shutter release button.
- You can interrupt an ongoing self-timer countdown by pressing the shutter release button while the self-timer lamp is flashing.
- The self-timer turns off automatically after the shutter releases.

Self-timer lamp

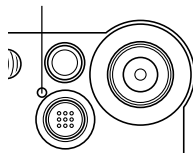

### Specifying Image Size and Quality

You can specify the image size and image quality to suit the type of image you are recording.

#### To specify the image size

1. In the REC mode, press MENU.
2. Rock the controller left or right to select the “REC” tab.
3. Rock the controller up or down to select “Size”, and then rock the controller to the right.
4. Rock the controller up or down to select the setting you want, and then click.

1600 x 1200 : 1600 x 1200 pixels

1280 x 960 : 1280 x 960 pixels

640 x 480 : 640 x 480 pixels

#### NOTE

- Use 1600 x 1200 when you plan to produce a large print of the image. Use 640 x 480 when you need to economize on space because you plan to send images in e-mail, etc.



## To specify the image quality

1. In the REC mode, press MENU.
2. Rock the controller left or right to select the “REC” tab.
3. Rock the controller up or down to select “Quality”, and then rock the controller to the right.
4. Rock the controller up or down to select the setting you want, and then click.

To get this:	Select this setting:
Very high quality, but large file size	Fine
Normal quality	Normal
Small file size, but low quality	Economy

### NOTE

- Use the “Fine” setting when image quality is your top priority and file size is secondary. Conversely, use the “Economy” setting when file size is your top priority and image quality is secondary.

### IMPORTANT!

- Actual file size depends on the type of image you record. This means that the remaining image capacity noted on the monitor screen may not be exactly accurate (pages 20 and 112).

# OTHER RECORDING FUNCTIONS

This chapter describes the other powerful features and functions that are available for recording.

## Exposure Compensation (EV Shift)

Exposure compensation lets you change the exposure setting (EV value) manually to adjust for the lighting of your subject. This feature helps to achieve better results when recording a backlit subject, a strongly lit subject indoors, and a subject that is against a dark background.

Exposure Compensation Range:  $-2.0\text{EV}$  to  $+2.0\text{EV}$   
Steps:  $1/3\text{EV}$

**1. In the REC mode, press MENU.**

**2. Select the “REC” tab, select “EV Shift”, and then rock the controller to the right.**

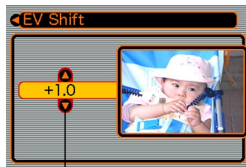

*Exposure compensation value*

**3. Rock the controller up or down to change the exposure compensation value, and then click.**

- Clicking the controller registers the displayed value.

Up : Increases the EV value. A higher EV value is best used for light-colored subjects and backlight subjects.



Down : Decreases the EV value. A lower EV value is best for dark-color subjects and for shooting outdoors on a clear day.

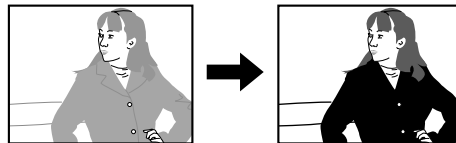

- To cancel exposure compensation, adjust the value until it becomes zero.

### 4. Record the image.

#### ▶▶ IMPORTANT! ◀◀

- When shooting under very dark or very bright conditions, you may not be able to obtain satisfactory results even after performing exposure compensation.

#### ▶▶ NOTE ◀◀

- You can use the key customization feature (page 51) to configure the camera so the exposure compensation value changes whenever you rock the controller left or right while in the REC mode.

## Adjusting the White Balance





The wavelengths of the light produced by various light sources (sunlight, light bulb, etc.) can affect the color of a subject when it is recorded. White balance lets you make adjustments to compensate for different lighting types, to make the colors of an image appear more natural.

1. In the REC mode, press MENU.
2. Select the “REC” tab, select “White Balance”, and then rock the controller to the right.



## OTHER RECORDING FUNCTIONS

### 3. Rock the controller up or down to select the setting you want, and then click.

When shooting under these conditions:	Select this setting:
Normal conditions	Auto
Outdoor daylight	
Shade	
Incandescent light bulb (reddish tinge)	
Fluorescent light (greenish tinge)	
Difficult lighting that requires manual control (This page)	Manual

### »» NOTES ««

- Selecting “Manual” changes white balance to the settings achieved the last time a manual white balance operation was performed.
- You can use the key customization feature (page 51) to configure the camera so the white balance setting changes whenever you rock the controller left or right while in the REC mode.

## Adjusting White Balance Manually

Under some light sources, automatic white balance under the “Auto” setting can take a long time to complete. Also, the auto white balance range (color temperature range) is limited. Manual white balance helps to ensure that colors are recorded correctly for a particular light source. Note that you must perform manual white balance under the same conditions you will be shooting under. You must also have a white piece of paper or other similar object on hand in order to perform manual white balance.

### 1. In step 3 of the procedure under “Adjusting the White Balance”, select “Manual”.

- This causes the object you last used to adjust manual white balance to appear on the monitor screen.



**2. Point the camera at a white piece of paper or similar object under the lighting conditions for which you want to set the white balance, and then press the shutter release button.**

- This adjusts the white balance.

**3. Click the controller.**

- This registers the white balance settings and returns to the REC mode.
- Dim lighting or pointing the camera at a dark colored object can cause white balance to take a long time to complete.

## Using the Night Scene Mode

You can use the Night Scene mode in combination with flash for slow sync shooting of people against a twilight or night scene background.

**1. In the REC mode, press MENU.**

**2. Select the “REC” tab, select “REC Mode”, and then rock the controller to the right.**



**3. Rock the controller up or down to select (Night Scene), and then click.**

**4. Record the image.**

**»» IMPORTANT! ««**

- In the Night Scene Mode, the camera may employ a slow shutter speed even when you are using the flash. Because of this, you need to guard against camera movement when using the Night Scene Mode.

### Using the Movie Mode

You can record movies up to 30 seconds long. The EX-M1 even lets you record audio along with your movies.

- File Format: AVI  
AVI format conforms to the Motion JPEG format promoted by the Open DML Group.
- Image Size: 320 x 240 pixels
- Movie File Size: Approximately 150KB/second.
- Maximum Movie Length
  - One Movie: 30 seconds
  - Total Movie Time:  
80 seconds with built-in memory; 410 seconds with 64MB SD memory card

1. In the REC mode, press MENU.
2. Select the “REC” tab, select “REC Mode”, and then rock the controller to the right.

3. Rock the controller up or down to select  (Movie), and then click.

- “Remaining capacity” shows how many 30-second movies can still be recorded to memory.

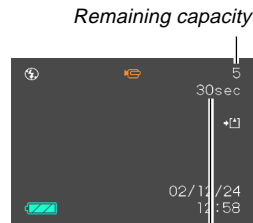

Remaining recording time

4. Point the camera at the subject and then press the shutter release button.
  - Movie recording continues for 30 seconds, or until you stop it by pressing the shutter release button again.
  - The remaining recording time value counts down on the monitor screen as you record.
5. After movie recording is stopped, press the shutter release button one more time to store the movie file.
  - This causes the movie file to be stored into camera memory.
  - To cancel storage of the movie file, rock the controller down to select “Delete” while file storage is being performed, and then click.

### ▶▶ IMPORTANT! ◀◀

- The flash does not fire in the Movie Mode.
- The EX-M1 also records audio. Note the following points when recording a movie with the EX-M1.
  - Take care that you do not block the microphone with your fingers.
  - Good recording results are not possible when the camera is too far from the subject.
  - Operating camera buttons during recording can cause button noise to be included in the audio.
  - Movie audio is recorded in monaural.

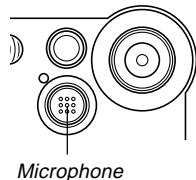

## Recording Audio (EX-M1 Only)

### Adding Audio to a Snapshot

You can add audio to a snapshot after you record it.

- **Image Format: JPEG**  
JPEG is an image format that provides efficient data compression.  
The file extension of a JPEG file is "JPG".
- **Audio Format: WAVE/ADPCM recording format**  
This is the Windows standard format for audio recording.  
The file extension of a WAVE/ADPCM file is "WAV".
- **Recording Time:**  
Up to about 30 seconds per image
- **Audio File Size:**  
Approximately 120KB (30-second recording of approximately 4KB per second)

## OTHER RECORDING FUNCTIONS

1. In the REC mode, press MENU.
2. Select the “REC” tab, select “REC Mode”, and then rock the controller to the right.
3. Rock the controller up or down to select  (Snapshot Audio), and then click.
  - This enters the Snapshot Audio Mode.

4. Press the shutter release button to record the image.

- After the image is recorded, the camera enters audio recording standby, with the image you just recorded on the monitor screen.
- You can cancel audio recording standby by pressing MENU.



*Remaining recording time*

5. Press the shutter release button to start audio recording.

- The operation/flash charge lamp flashes green as recording is performed.
- Even if you have the monitor screen turned off (page 50), the monitor screen turns on while you are adding audio to a snapshot.

6. Recording stops after about 30 seconds or when you press the shutter release button.



### Recording Your Voice

The Voice Recording Mode provides quick and easy recording of your voice.

- **Audio Format:** WAVE/ADPCM recording format  
This is the Windows standard format for audio recording. The file extension of a WAVE/ADPCM file is "WAV".
- **Recording Time:**  
Approximately 50 minutes with built-in memory
- **Audio File Size:**  
Approximately 120KB (30-second recording of approximately 4KB per second)

- 1. In the REC mode, press MENU.**
- 2. Select the "REC" tab, select "REC Mode", and then rock the controller to the right.**
- 3. Rock the controller up or down to select  (Voice Recording), and then click.**

- This enters the Voice Recording Mode.

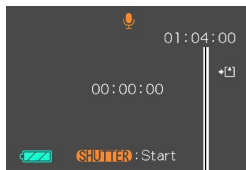

*Remaining recording time*

- 4. Press the shutter release button to start voice recording.**

- The remaining recording time value counts down on the monitor screen and the operation/flash charge lamp flashes green as recording is performed.
- Clicking the controller during voice recording turns off the monitor screen. The monitor screen turns back on automatically when recording is complete.

- 5. Recording stops when you press the shutter release button, when memory becomes full, or when the battery goes dead.**

### ■ Audio Recording Precautions

- Keep the microphone on the front of the camera pointed at the subject.
- Take care that you do not block the microphone with your fingers.
- Good recording results are not possible when the camera is too far from the subject.
- Operating camera buttons during recording can cause button noise to be included in the audio.
- Pressing the power button or changing the mode selector setting stops recording at that point and stores any audio recorded up to that point.
- You can also perform “after-recording” to add audio to a snapshot after recording it, and also change the audio recorded for an image. See page 58 for more information.

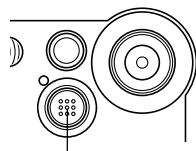

Microphone

## REC Mode Camera Settings

### Turning the Monitor Screen On and Off

Turning off the monitor screen when recording helps to conserve battery power.

1. In the REC mode, press MENU.
2. Select the “REC” tab, select “Indicators”, and then rock the controller to the right.
3. Rock the controller up or down to select the setting you want, and then click.

To do this:	Select this setting:
Turn off the monitor screen	LCD-ON
Turn on the monitor screen	LCD-OFF

## OTHER RECORDING FUNCTIONS

### ▶▶ IMPORTANT! ◀◀

- The monitor screen turns back on automatically in the following cases, even if "LCD-OFF" is selected with the above procedure.
  - When you press MENU (Monitor screen remains on for about one minute.)
  - When you rock the controller left or right
  - When you enter the Movie Mode or Voice Recording Mode for recording
  - When you use the Snapshot Audio Mode to add audio to a snapshot

## Assigning Functions to the Controller

A "key customization" feature lets you assign a setting function to the controller. After you assign a function, the corresponding parameter is changed whenever you rock the controller left or right in the REC mode.

- 1. In the REC mode, press MENU.**
- 2. Select the "REC" tab, select "L/R Key", and then rock the controller to the right.**

### 3. Rock the controller up or down to select the setting you want, and then click.

When you want to assign this function to the controller :	Select this:
Recording mode <ul style="list-style-type: none"><li>• Rock left or right to cycle through modes.</li><li>• EX-S1: Snapshot, Night Scene, Movie</li><li>• EX-M1: Snapshot, Night Scene, Movie, Snapshot Audio, Voice Recording (page 104)</li></ul>	REC Mode
Exposure compensation <ul style="list-style-type: none"><li>• Rock left to decrease, rock right to increase (page 42)</li></ul>	EV Shift
Flash mode <ul style="list-style-type: none"><li>• Rock left or right to cycle through modes (page 37).</li></ul>	Flash
White balance mode <ul style="list-style-type: none"><li>• Rock left or right to cycle through modes (page 43).</li></ul>	White Balance

### ▶▶ NOTE ◀◀

- The initial default setting is "REC Mode".

## Specifying Power On Default Settings

The camera's "mode memory" feature lets you specify the power on default settings individually for the recording mode, flash mode, digital zoom mode, and white balance mode. Turning on mode memory for a mode tells the camera to remember the status of that mode when you turn off the camera, and restore it the next time you turn the camera back on. When mode memory is turned off, the camera automatically restores the initial factory default setting for the applicable mode.

The following table shows what happens when you turn mode memory on or off for each mode.

Mode	Mode Memory Off (Factory Default)	Mode Memory On
Recording Mode	Snapshot	<ul style="list-style-type: none"> <li>Remembers the current status when the camera is turned off, and restores it when the camera is turned back on again.</li> </ul>
Flash Mode	Auto	
Digital Zoom Mode	On	
White Balance Mode	Auto	

1. In the REC mode, press MENU.
2. Select the "Memory" tab, select the item you want to change, and then rock the controller to the right.
3. Rock the controller up or down to select the setting you want, and then click.

To do this:	Select this setting:
Turn on mode memory so settings are restored at power on	On
Turn off mode memory so settings are initialized at power on	Off

# PLAYBACK

You can use the camera's built in monitor screen to play back files.

## Basic Playback Operation

Use the following procedure to scroll through files stored in the camera's memory.

### 1. Press the power button to turn on the camera.

- This causes an image or a message to appear on the monitor screen.

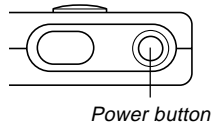

### 2. Align the mode selector with "PLAY".

- This enters the PLAY mode.

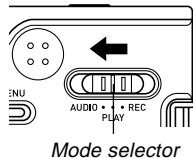

### 3. Rock the controller right (forward) or left (back) to scroll through files on the monitor screen.



### NOTES

- Holding the controller to the left or right scrolls at high speed.
- Note that the images produced on the monitor screen of this camera are simplified versions of the actual image stored in memory.

## Playing an Audio Snapshot (EX-M1 Only)

Perform the steps below to display an audio snapshot (indicated by a  indicator) and play its audio.

**1. In the PLAY mode, rock the controller left or right until the image you want is displayed.**

**2. Click the controller.**

- This plays back the audio that accompanies the displayed image.
- You can perform the following operations while audio is playing.



To do this:	Do this:
Fast forward or fast reverse the audio	Rock the controller left or right.
Pause and unpause audio playback	Click the controller.
Adjust audio volume	Rock the controller up or down.
Cancel playback	Press MENU.

### ▶▶ IMPORTANT! ◀◀

- Audio volume can be adjusted during playback only.
- When you have the LCD remote controller connected to the camera, audio is output through the stereo headphones (page 95) instead of the camera's speaker. Output through the headphones is monaural.

### Zooming the Displayed Image

Perform the following procedure to zoom the image currently on the monitor screen up to four times its normal size.

1. In the **PLAY** mode, rock the controller left or right until the image you want is displayed.
2. Press **MENU**.
3. Select the “**PLAY**” tab, select “**Zoom**”, and then rock the controller to the right.
4. Rock the controller up to enlarge the image, or down to reduce its size.



5. After clicking the controller, you can then rock it up, down, left, or right to scroll to different parts of the zoomed image.



- After clicking again, you can rock the controller up or down to zoom in and out on the image again.
6. Press **MENU** to return the image to its original size.

#### ▶▶ IMPORTANT! ◀◀

- You cannot enlarge a movie image.

## Resizing an Image

You can use the following procedure to change a snapshot image to either VGA size (640 x 480 pixels) or QVGA size (320 x 240 pixels).

- VGA size and QVGA size are the optimum image sizes for attachment to e-mail messages or incorporation into Web pages.

1. In the **PLAY** mode, press **MENU**.
2. Select the **“PLAY”** tab, select **“Resize”**, and then rock the controller to the right.
3. Rock the controller left or right to scroll through images and display the one you want to resize.



4. Rock the controller up or down to select the setting you want, and then click.

To do this:	Select this:
Resize to 640 x 480 pixels (VGA)	640 x 480
Resize to 320 x 240 pixels (QVGA)	320 x 240
Cancel the resizing operation	Cancel

### ►► IMPORTANT! ◀◀

- Resizing an image causes a new (resized) version to be stored as a separate file.
- Images smaller than 320 x 240 pixels cannot be resized.
- Note that you can resize snapshots recorded with this camera only.
- If the message “The function is not supported for this file”. appears, it means that the current image cannot be resized.
- The resize operation cannot be performed if there is not enough memory to store the resized image.



## Playing a Movie

Use the following procedure to play back a movie recorded in the movie mode.

- In the PLAY mode, rock the controller left or right until the movie you want to play is displayed.**

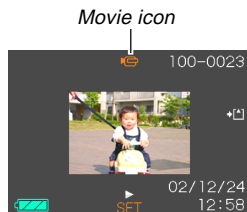

- Click the controller.**

- This start playback of the movie.

- You can perform the following operations while a movie is playing.

To do this:	Do this:
Fast forward or fast reverse the movie	Rock the controller left or right.
Pause and unpause movie playback	Click the controller.
Skip forward or back one frame while paused	Rock the controller left or right.
Cancel playback	Press MENU.
Adjust audio volume (EX-M1 only)	Rock the controller up or down.

### ►► IMPORTANT! ◀◀

- A movie plays until the end and then stops. You cannot repeat-play a movie.
- Audio volume can be adjusted during playback only.
- When you have the LCD remote controller connected to the camera, audio is output through the stereo headphones (page 95) instead of the camera's speaker. Output through the headphones is monaural.

**Adding Audio to a Snapshot (EX-M1 Only)**

The “after-recording” feature lets you add audio to snapshots after they are recorded. You can also re-record an audio image (one with a  icon on it).

- **Audio Format:** WAVE/ADPCM recording format  
This is the Windows standard format for audio recording. The file extension of a WAVE/ADPCM file is “WAV”.
- **Recording Time:**  
Up to about 30 seconds per image
- **Audio File Size:**  
Approximately 120KB (30-second recording of approximately 4KB per second)

**1. In the PLAY mode, rock the controller left or right to scroll through snapshots until the one to which you want to add audio is displayed.**

**2. Press MENU.**

**3. Select the “PLAY” tab, select “Dubbing”, and then rock the controller to the right.**



**4. Press the shutter release button to start audio recording.**

**5. Recording stops after about 30 seconds or when you press the shutter release button.**

## To re-record audio

1. In the PLAY mode, rock the controller left or right to scroll through snapshots until the one whose audio you want to re-record is displayed.
2. Select the “PLAY” tab, select “Dubbing”, and then rock the controller to the right.
3. Rock the controller up or down to select “Delete”, and then click.
  - If you merely want to delete the audio with re-recording, press MENU here to complete the procedure.
4. Press the shutter release button to start audio recording.
5. Recording stops after about 30 seconds or when you press the shutter release button.
  - This deletes the previous recording and replaces it with a new one.

### ▶▶ IMPORTANT! ◀◀

- Keep the microphone on the front of the camera pointed at the subject.
- Take care that you do not block the microphone with your fingers.

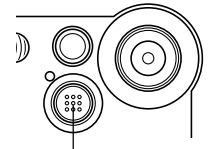

*Microphone*

- Good recording results are not possible when the camera is too far from the subject
- Operating camera buttons during recording can cause button noise to be included in the audio.
- The  (Audio) icon appears on the monitor screen after audio recording is complete.
- You will not be able to record audio when remaining memory capacity is low.
- The following types of audio recording are not supported.
  - Adding audio to a movie image
  - Adding audio to a protected snapshot (page 64)
- Audio that is re-recorded or deleted cannot be recovered. Make sure you no longer need audio before re-recording or deleting it.

## Playing Back a Voice Recording File (EX-M1 Only)

Perform the following steps to play back a voice recording file.

- 1. In the PLAY mode, rock the controller left or right to display the voice file (a file with  on it) you want to play.**
- 2. Click the controller.**

- This starts playback of the voice recording file through the camera's speaker.
- You can perform the following operations while audio is playing.

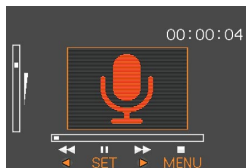

To do this:	Do this:
Fast forward or fast reverse the audio	Rock the controller left or right.
Pause and unpauses audio playback	Click the controller.
Adjust audio volume	Rock the controller up or down.
Cancel playback	Press MENU.

### IMPORTANT!

- Audio volume can be adjusted during playback only.
- When you have the LCD remote controller connected to the camera, audio is output through the stereo headphones (page 95) instead of the camera's speaker. Output through the headphones is monaural.

# DELETING FILES

You can delete a single file, or you can delete all files currently in memory.

## »» IMPORTANT! ««

- Note that file deletion cannot be undone. Once you delete a file, it is gone. Make sure you really do not need a file anymore before you delete it. Especially when deleting all files, make sure you check all the files you have stored before proceeding.
- Delete cannot be performed when all the files in memory are protected (page 64).
- A protected file cannot be deleted. To delete a protected file, unprotect it first (page 64).
- On the EX-M1, deleting an audio snapshot deletes both the image file and the audio file attached to it.

## Deleting a Single File

Perform the following steps when you want to delete a single file.

1. In the PLAY mode, rock the controller down .



2. Rock the controller left or right to scroll through files and display the one you want to delete.
3. Rock the controller up or down to select "Delete".
  - To exit the file delete operation without deleting anything, select "Cancel".
4. Click the controller to delete the file.
  - Repeat steps 2 through 4 to delete other files, if you want.
5. Press MENU to exit the menu screen.

### »» IMPORTANT! ««

- If a file cannot be deleted for some reason, the message “The function is not supported for this file.” appears when you try to delete it.

### Deleting All Files

The following procedure deletes all unprotected files currently in memory.

- 1. In the PLAY mode, rock the controller down .**
- 2. Rock the controller up or down to select “All File Delete”, and then click.**
- 3. Rock the controller up or down to select “Yes”.**
  - To exit the file delete operation without deleting anything, select “No”.
- 4. Click the controller to delete all the files.**

## Free Manuals Download Website

<http://myh66.com>

<http://usermanuals.us>

<http://www.somanuals.com>

<http://www.4manuals.cc>

<http://www.manual-lib.com>

<http://www.404manual.com>

<http://www.luxmanual.com>

<http://aubethermostatmanual.com>

Golf course search by state

<http://golfingnear.com>

Email search by domain

<http://emailbydomain.com>

Auto manuals search

<http://auto.somanuals.com>

TV manuals search

<http://tv.somanuals.com>