

# LK-35

## USER'S GUIDE GUÍA DEL USUARIO



P  
英 西  
LK35-ES-1

**CASIO®**

**GUIDELINES LAID DOWN BY FCC RULES FOR USE OF THE UNIT IN THE U.S.A. (not applicable to other areas).**

**NOTICE**

This equipment has been tested and found to comply with the limits for a Class B digital device, pursuant to Part 15 of the FCC Rules. These limits are designed to provide reasonable protection against harmful interference in a residential installation. This equipment generates, uses and can radiate radio frequency energy and, if not installed and used in accordance with the instructions, may cause harmful interference to radio communications. However, there is no guarantee that interference will not occur in a particular installation. If this equipment does cause harmful interference to radio or television reception, which can be determined by turning the equipment off and on, the user is encouraged to try to correct the interference by one or more of the following measures:

- Reorient or relocate the receiving antenna.
- Increase the separation between the equipment and receiver.
- Connect the equipment into an outlet on a circuit different from that to which the receiver is connected.
- Consult the dealer or an experienced radio/TV technician for help.

**FCC WARNING**

Changes or modifications not expressly approved by the party responsible for compliance could void the user's authority to operate the equipment.



CASIO ELECTRONICS CO., LTD.  
Unit 6, 1000  
North Circular Road  
London NW2 7JD, U.K.

This mark is valid in the EU countries only.  
Please keep all information for future reference.

475A-E-002A

## Welcome...

To the happy family of satisfied CASIO electronic musical instrument owners! To get the most out of the many features and functions of the keyboard, be sure to carefully read this manual and keep it on hand for future reference.

### **Important!**

When using batteries, be sure to replace them or shift to one of the alternate power sources whenever you notice any of the following symptoms.

- Dim power supply indicator
- Instrument does not turn on
- Dim, difficult to read display
- Abnormally low speaker/headphone volume
- Distortion of sound output
- Occasional interruption of sound when playing at high volumes
- Sudden power failure when playing at high volumes
- Dimming of the display when playing at high volume
- Abnormal rhythm pattern and demo tune play
- Dimming of keyboard lights when notes sound

## Main Features

- ❑ **100 amazingly realistic tones**
- ❑ **Enhanced auto-accompaniment function for greater versatility**
  - 100 built in auto-accompaniment patterns.
- ❑ **100 Built-in Song Bank tunes**
  - A total of 100 built-in Song Bank tunes comes built in for playback enjoyment or play-along practice.
- ❑ **A three-step lesson function lets you develop your musical skills by following the keys as they light (Three Step Lesson System).**
  - First you become familiar with the timing of the notes by watching the keys light as you playback one of the 100 built-in Song Bank tunes. Next, practice playing along at a pace that's comfortable for you. Finally, try playing along at the normal tempo for the Song Bank tune.
- ❑ **Auto Accompaniment**
  - Simply specify a chord and the keyboard automatically produces the matching rhythm, bass, and chord patterns. One-touch fill-ins make accompaniments sound interesting and natural.
- ❑ **Transpose Function**
  - An easy operation instantly changes the key of the keyboard.

## Safety Precautions

### Symbols

Various symbols are used in this operating manual and on the product itself to ensure that the product is used safely and correctly, and to prevent injury to the user and other persons as well as damage to property. Those symbols along with their meanings are shown below.

#### **WARNING**

This indication stipulates matters that have the risk of causing death or serious injury if the product is operated incorrectly while ignoring this indication.

#### **CAUTION**

This indication stipulates matters that have the risk of causing injury as well as matters for which there is the likelihood of occurrence of physical damage only if the product is operated incorrectly while ignoring this indication.

### Symbol Examples



This triangle symbol () means that the user should be careful. (The example at left indicates electrical shock caution.)



This circle with a line through it () means that the indicated action must not be performed. Indications within or nearby this symbol are specifically prohibited. (The example at left indicates that disassembly is prohibited.)



The black dot () means that the indicated action must be performed. Indications within this symbol are actions that are specifically instructed to be performed. (The example at left indicates that the power plug must be unplugged from the electrical socket.)

### **WARNING**

**Please use caution regarding the handling of the AC adaptor.**

- Do not use a voltage other than the indicated power supply voltage. Use of a voltage other than that indicated may cause fire or electrical shock.
- If the power cord should become damaged (exposed wires, disconnection, etc.), purchase a new AC adaptor. Use of a damaged power cord may cause fire or electrical shock.
- Do not cut or damage the power cord. Also do not place heavy objects on top of it or subject it to excessive heat. Damage to the power cord may cause fire or electrical shock.
- Do not attempt to shape the power cord or subject it to excessive bending, twisting or pulling. This may cause fire or electrical shock.
- Please use the adaptor specified for this instrument. Use of another adaptor may cause fire, electrical shock, or malfunction.



**Do not locate the instrument or its stand on an uneven or unstable surface.**

- Locating the instrument or its stand on an uneven or unstable surface can cause it to fall, creating the danger of personal injury.

E-2

475A-E-004A

**Do not place containers containing water or other liquids on the instrument.**

- Do not place the following objects on the instrument. Placing such objects on the instrument may cause fire or electrical shock if they spill and get inside the instrument.

- Containers filled with water or other liquids (including vases, potted plants, cups, cosmetics and medicines)
- Small metal objects (including hairpins, sewing needles and coins)
- Flammable objects

In the event a foreign object should happen to get inside the instrument, please take the following actions:

1. Turn power off.
2. Unplug the AC adaptor from the wall outlet.
3. If there are any batteries loaded in the keyboard, remove them.
  - Do not touch the batteries directly with your hands when removing them. They may be hot or battery fluid may be leaking from them.
4. Consult with the dealer where you purchased the keyboard or with an authorized CASIO service provider.



**Do not disassemble or modify the instrument.**

- Never attempt to take apart or modify the instrument, its accessories, or separately sold options. Doing so may cause fire, electrical shock or malfunction. Consult your dealer concerning all inspection, adjustment or repair of internal components.



**Do not use if there is an abnormality or malfunction.**

- Do not use the instrument if there appear to be abnormalities such as the presence of smoke or abnormal odor. Also do not use the instrument if there appear to be malfunctions such as the power not coming on or sound not being produced. Use under such conditions may cause fire or electrical shock. In such cases, take the following actions immediately. Never attempt to repair the instrument yourself.



1. Turn power off.
2. Unplug the AC adaptor from the wall outlet.
3. If there are any batteries loaded in the keyboard, remove them.
  - Do not touch the batteries directly with your hands when removing them. They may be hot or battery fluid may be leaking from them.
4. Consult with the dealer where you purchased the keyboard or with an authorized CASIO service provider.



**When the instrument has been dropped:**

- In the case the instrument has been dropped or damaged, take the following actions. Continued use may cause fire or electrical shock.



1. Turn power off.
2. Unplug the AC adaptor from the wall outlet.
3. If there are any batteries loaded in the keyboard, remove them.
  - Do not touch the batteries directly with your hands when removing them. They may be hot or battery fluid may be leaking from them.
4. Consult with the dealer where you purchased the keyboard or with an authorized CASIO service provider.



**Be careful of the bags around children.**

- Never allow anyone to place the plastic bags of the instrument, its accessories, and its separately sold options over their heads. Doing so may cause suffocation. Particular caution is required in homes with small children.

---

---

## ⚠ CAUTION

---

---

### AC Adaptor

- Do not locate the power cord in close proximity to heaters or other heating appliances. This may cause the cord to melt leading to possible fire or electrical shock.
- When unplugging the AC adaptor from an electrical outlet, always make sure to pull on the adaptor itself and not the cord. Pulling excessively on the cord may cause it to be damaged or break leading to possible fire or electrical shock.
- Do not touch the AC adaptor with wet hands when it is plugged in. This may cause electrical shock.
- When not using the instrument for an extended period such as when traveling, always make sure to unplug the AC adaptor from the electrical outlet for safety reasons.
- After use turn off the power switch of the instrument and unplug the AC adaptor from the electrical outlet.
- At least once a year, unplug the AC adaptor from the power outlet and clean the area around the prongs of the plug. Dust build up around the prongs can create the danger of fire.



### Batteries

- Improper battery use may cause batteries to rupture and leak. This may cause injury, malfunction of the instrument or discoloration of furniture and other articles that come into contact with battery fluid. Take care to observe the following.
  - Install batteries so their polarity (+/-) matches that indicated on the instrument.
  - For safety and to prevent possible leakage of battery fluid, always make sure to remove batteries from the instrument when you do not plan to use it for a long time.
  - Always make sure that the batteries making up a set are all of the same type.
  - Never combine new batteries with old ones.
  - Never dispose of batteries by incinerating them. Never short or disassemble batteries, and do not expose them to excessive heat.
  - Replace dead batteries as soon as possible.
  - Never attempt to recharge batteries.

### Transport

- When transporting the instrument, always make sure to unplug the AC adaptor from the electrical outlet and confirm that all other external connections have been disconnected. Only then should the instrument be transported. If the above is not done, the cord may be damaged leading to possible fire or electrical shock.



### Care

- Whenever caring, make sure to first unplug the AC adaptor from the electrical outlet. Also remove the instrument's batteries if battery power is being used.



### Location

- Never locate the instrument in areas subject to high humidity or heavy accumulation of dust. Doing so may cause fire or electrical shock.
- Never locate the instrument in areas subject to grease splatters or steam, such as in a kitchen or near a humidifier. Doing so may cause fire or electrical shock.



### Do not place keyboard on lacquered furniture.

- The instrument's silicone rubber feet may eventually blacken or scar lacquered surfaces. Use felt cloth pads to insulate the feet or preferably use a CASIO musical instrument stand designed for your keyboard.

E-4

475A-E-006A

---

**Do not place heavy objects on the instrument.**

- Do not place heavy objects on the instrument. This may cause the instrument to tip over or break resulting in injury.

**Volume**

- Very high volume levels can damage hearing. Avoid using the instrument at very high volume settings for long periods. Consult with a physician immediately if you experience impaired hearing or ringing in the ears.

**Do not get onto the instrument or stand.**

- Do not crawl on top of the instrument or its optional stand. Particular caution is required in homes having small children. This may cause the instrument or stand to tip over and break resulting in injury.

**Optional Stand (sold separately)**

- Carefully assemble the stand following the assembly instructions that come with it. Securely tighten all bolts, nuts, and fasteners, and make sure that you mount the instrument correctly onto the stand. Incorrectly or insufficiently tightening screws, or incorrectly mounting the instrument onto the stand can cause the stand to tip over or the instrument to fall off the stand, possibly leading to injury.

**Accessories and options**

- Use only accessories that come with the instrument or authorized CASIO options (sold separately). Use of non-specified accessories or options may cause fire, electrical shock, or malfunction.

- You may not be able to see the keyboard keys light under direct sunlight or in other brightly lit areas.

## Care of Your Keyboard

**Avoid heat, humidity or direct sunlight.**

Do not overexpose the instrument to direct sunlight, or place it near an air conditioner, or in any extremely hot place.

**Do not use near a TV or radio.**

This instrument can cause video or audio interference with TV and radio reception. If this happens, move the instrument away from the TV or radio.

**Do not use lacquer, thinner or similar chemicals for cleaning.**

Clean the keyboard with a soft cloth dampened in a weak solution of water and a neutral detergent. Soak the cloth in the solution and squeeze until it is almost dry.

**Note**

- You may notice lines in the finish of the case of this keyboard. These lines are a result of the molding process used to shape the plastic of the case. They are not cracks or breaks in the plastic, and are no cause for concern.

## Contents

Welcome.....	E-1
Main Features .....	E-1
Safety Precautions .....	E-2
Care of Your Keyboard .....	E-5
Contents .....	E-6
Control Locations .....	E-8
Quick Reference .....	E-10
Connections .....	E-12
Phones/Output Jack .....	E-12
Power Supply .....	E-14
Using batteries.....	E-14
To load batteries.....	E-14
Important Battery Information .....	E-14
Using the AC Adaptor .....	E-15
Auto Power Off .....	E-16
Power On Alert .....	E-16
To disable Auto Power Off and power on alert .....	E-16
Basic Operations .....	E-17
To switch power on and off .....	E-17
To change tones.....	E-17
Keyboard split tones .....	E-18
Digital Sampling .....	E-19
Polyphony .....	E-19
Other Useful Functions .....	E-19
To change the key of the keyboard .....	E-19
To tune the keyboard .....	E-20



Playing the demo tunes .....	E-21
To start demo tune play .....	E-21
To stop demo tune play .....	E-21
Playing rhythms .....	E-22
To select and play a rhythm .....	E-22
Using auto-accompaniment .....	E-23
About the accompaniment keyboard .....	E-23
Using the CASIO CHORD system .....	E-24
To play a CASIO CHORD auto-accompaniment .....	E-24
Using standard fingerings .....	E-25
To play a FINGERED auto-accompaniment .....	E-26
Improvising with the preset patterns .....	E-27
Using fill-in rhythm .....	E-27
Using Synchro start .....	E-27

### **Three Step Lesson System ..... E-28**

Using Three Step Lesson System .....	E-28
Three Step Lesson System Tempo Setting .....	E-29
To play a built-in Song Bank tune .....	E-29
Using the Three Step Lesson System with Song Bank Tunes .....	E-30
How the Three Step Lesson System operates in Steps 1 through 3 .....	E-31
Turning Off Key Lighting .....	E-32
Number of Simultaneously Lit Keys .....	E-32
To change the tone used for the melody of a Song Bank tune .....	E-32
Step 1: Easy Play .....	E-33
Step 2: Slow Play .....	E-33
Step 3: Normal Play .....	E-34
To practice the left hand part .....	E-35
To check if the right hand or left hand part is currently selected .....	E-35

### **Technical Reference ..... E-36**

Troubleshooting .....	E-36
Specifications .....	E-38

### **Appendix ..... A-1**

Fingered Chord Charts .....	A-1
Rhythm List .....	A-3

# Control Locations

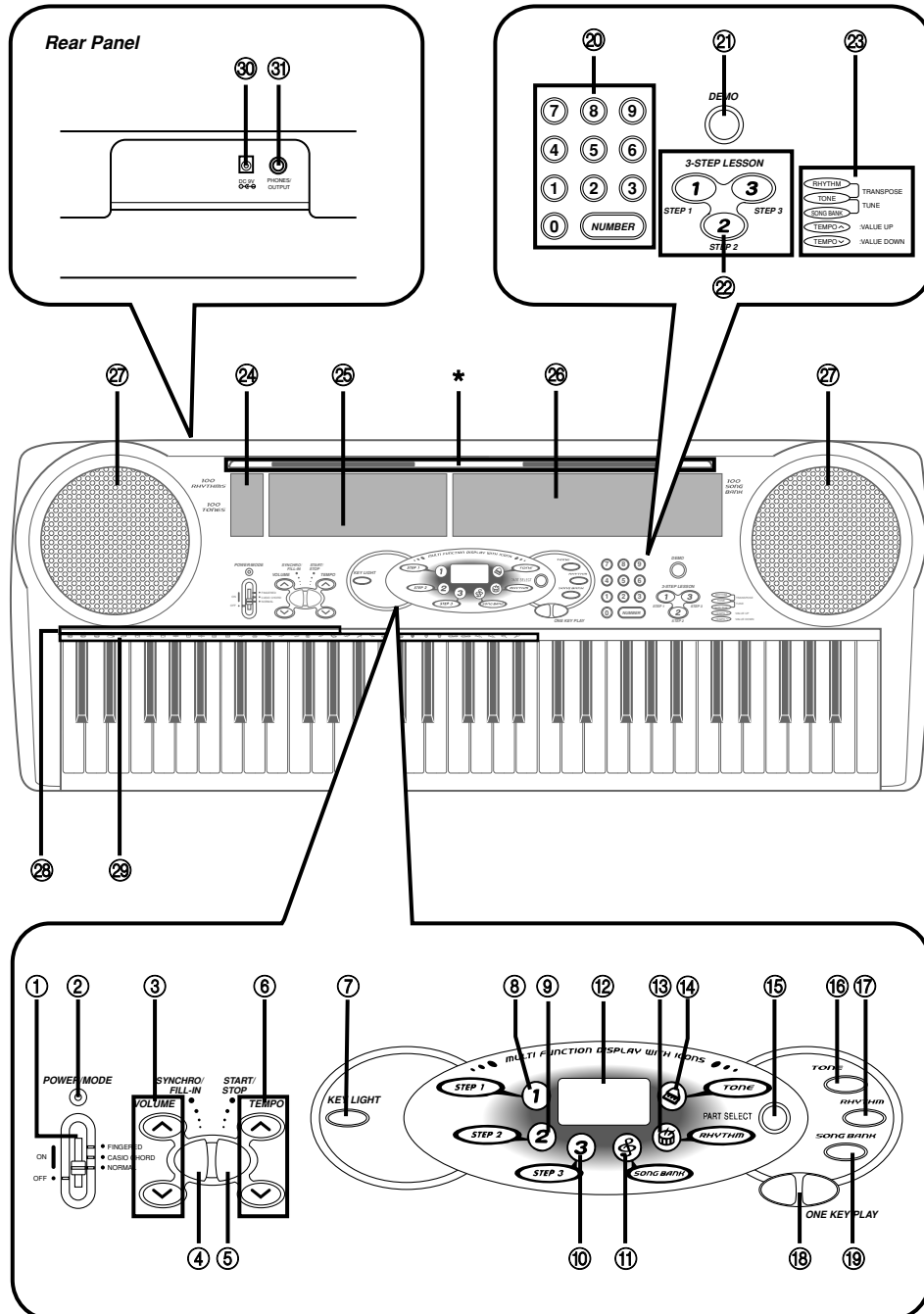

E-8

475A-E-010A

- |  |   |
|--|---|
| <ul style="list-style-type: none"> <li>① POWER/MODE selector</li> <li>② Power indicator</li> <li>③ VOLUME buttons</li> <li>④ SYNCHRO/FILL-IN button</li> <li>⑤ START/STOP button</li> <li>⑥ TEMPO buttons</li> <li>⑦ KEY LIGHT button</li> <li>⑧ STEP 1 icon</li> <li>⑨ STEP 2 icon</li> <li>⑩ STEP 3 icon</li> <li>⑪ SONG BANK icon</li> <li>⑫ Display</li> <li>⑬ RHYTHM icon</li> <li>⑭ TONE icon</li> <li>⑮ PART SELECT button</li> <li>⑯ TONE button</li> <li>⑰ RHYTHM button</li> </ul> | <ul style="list-style-type: none"> <li>⑱ ONE KEY PLAY buttons</li> <li>⑲ SONG BANK button</li> <li>⑳ Number buttons</li> <li>㉑ DEMO button</li> <li>㉒ 3-STEP LESSON buttons</li> <li>㉓ TRANSPOSE/TUNE operation guide</li> <li>㉔ 100 RHYTHMS list<br/>See "Rhythm List" on page A-3 for details.</li> <li>㉕ 100 TONES list</li> <li>㉖ 100 SONG BANK list</li> <li>㉗ Speakers</li> <li>㉘ CHORD ROOT NAMES</li> <li>㉙ Percussion instrument list</li> <li>㉚ DC 9V jack</li> <li>㉛ PHONES/OUTPUT jack<br/>For connection of commercially available headphones. Output from the speakers is automatically cut when headphones are connected.</li> </ul> |
|--|---|

**\* Attachment of Score Stand**

Insert the score stand into the slot at the top of the keyboard as shown in the illustration.

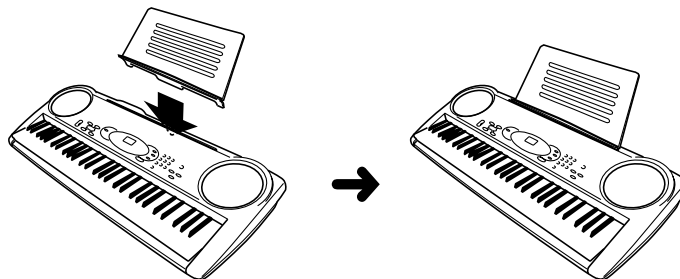

475A-E-011A

E-9

## Quick Reference

This section provides a quick overview of keyboard operation using steps one and two of the 3-step lesson feature. See page E-28 for detailed explanations of these steps.

**1**

Set the **POWER/MODE** selector to **NORMAL**.

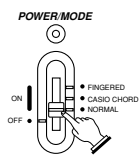

**2**

Press the **SONG BANK** button.



**3**

Find the tune you want in the Song Bank list, and press the **number button** corresponding to the number.

- To select "20 A [2] and the [0]."

**5**

Play the melody part on the keyboard.

<If you pressed the **STEP 1** button in **4** ...>  
Play the notes with the **ONE KEY PLAY** buttons.

- The accompaniment tempo automatically adjusts to play along with your melody.



<If you pressed the **STEP 1** button in **4** ...>  
Play the notes on the keyboard.

- Keep the key pressed.
- If you selected a note, the note goes out as soon as you release the key.
- The key that you need to play the melody part.
- After you press the key, the accompaniment tempo automatically adjusts to play along with your melody.

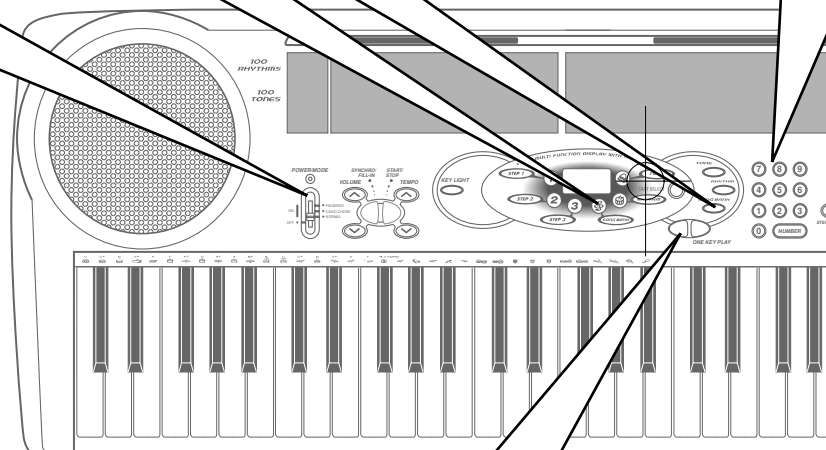

**3**

Find the tune you want to play in the Song Bank list, and then use the **number buttons** to input its two-digit number.

- To select "20 AMAZING GRACE", input [2] and the [0].

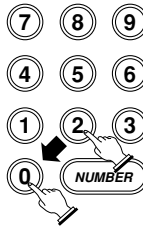

**4**

Press the **STEP 1 button** or **STEP 2 button**.

- When you do, the STEP 1 icon or STEP 2 icon lights.
- The keyboard sounds a count beat and waits for you to play something on the keyboard. The keys that you need to press first flash.

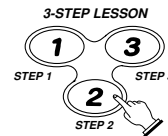

<If you pressed the **STEP 2 button** in **4** ...>

Play the notes on the keyboard, pressing keys as they light.

- Keep the key depressed as long as it stays lit.
- If you selected any song from number 85 through 99, the lit key goes out as soon as you press it.
- The key that corresponds to the next note you need to play will flash.
- After you press the correct melody key, accompaniment proceeds to the next note.

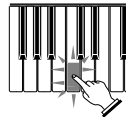

## Connections

### ■ Phones/Output Jack

Before connecting headphones or other external equipment, be sure to first turn down the volume settings of the keyboard and the connected equipment. You can then adjust volume to the desired level after connections are complete.

[Rear Panel]

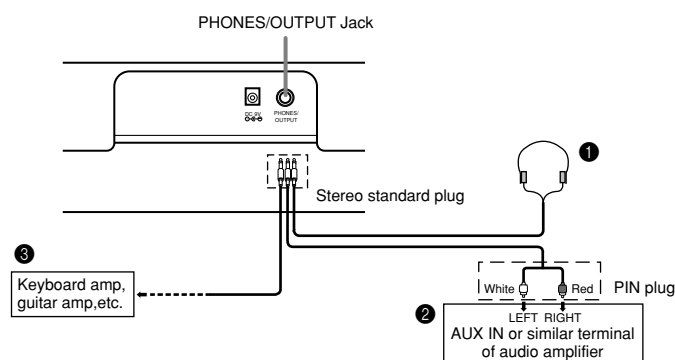

#### Connecting Headphones (Figure 1)

Connecting headphones cuts off output from the keyboard's built-in speakers, so you can play even late at night without disturbing anyone.

#### Audio Equipment (Figure 2)

Connect the keyboard to an audio equipment using a commercially available connecting cord with a standard plug on one end and two PIN plugs on the other end. Note that the standard plug you connect to the keyboard must be a stereo plug, otherwise you will be able to output only one of stereo channels. In this configuration, you normally set the input selector of the audio equipment to the terminal (usually marked AUX IN or something similar) where the cord from the keyboard is connected. See the user documentation that comes with your audio equipment for full details.

#### Musical Instrument Amplifier (Figure 3)

Use a commercially available connecting cord to connect the keyboard to a musical instrument amplifier.

#### Note

- Be sure to use a connecting cord that has a stereo standard plug on the end you connect to the keyboard, and a connector that provides dual channel (left and right) input to the amplifier to which you are connecting. The wrong type of connector at either end can cause one of the stereo channels to be lost.

When connected to a musical instrument amplifier, set the volume of the keyboard to a relatively low level and make output volume adjustments using the amplifier's controls.

**Connection Example**

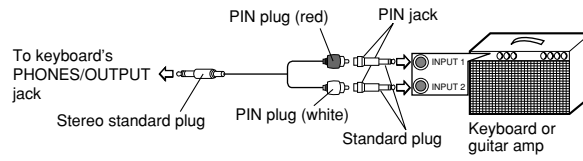

## Power Supply

This keyboard can be powered by current from a standard household wall outlet (using the specified AC adaptor) or by batteries. Always make sure you turn the keyboard off whenever you are not using it.

### ■ Using batteries

Always make sure you turn off the keyboard before loading or replacing batteries.

#### To load batteries

1. Remove the battery compartment cover.
2. Load 6 AA-size batteries into the battery compartment.
  - Make sure that the positive (+) and negative (-) ends are facing correctly.
3. Insert the tabs on the battery compartment cover into the holes provided and close the cover.

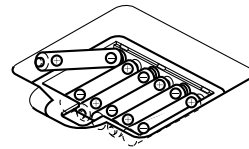

The keyboard may not function correctly if you load or replace batteries with power turned on. If this happens, turning the keyboard off and then back on again should return functions back to normal.

#### Important Battery Information

- The following shows the approximate battery life provided by different battery types.

- Standard battery life: Approximately 1 hour (SUM3/R6P)  
Approximately 4 hours (AM3/LR6)

Both of the above values are standard battery life at normal temperature, with the keyboard volume at a medium setting. Temperature extremes or playing at very loud volume settings can shorten battery life.

- Any of the following symptoms indicate low battery power. Replace batteries as soon as possible whenever any of the following occurs.

- Dim power supply indicator
- Instrument does not turn on
- Dim, difficult to read display
- Abnormally low speaker/headphone volume
- Distortion of sound output
- Occasional interruption of sound when playing at high volumes
- Sudden power failure when playing at high volumes
- Dimming of the display when playing at high volume
- Abnormal rhythm pattern and demo tune play
- Dimming of keyboard lights when notes sound



### Important!

Improper handling of batteries can cause them to burst and leak, which creates the danger of personal injury or damage due to contact with battery acid. Be sure to note the following important precautions.

- Always make sure that the positive (+) and negative (-) poles are facing correctly as indicated inside the battery compartment.
- To avoid damage caused by leaking batteries, be sure to remove batteries from the keyboard whenever you leave it unattended for long periods (such as when leaving on a trip).
- Never mix batteries of different types.
- Never mix old batteries with new ones.
- Never discard batteries by incinerating them, do not allow their poles to be shorted (connected to each other), never take batteries apart, and do not expose batteries to direct heat.
- Replace batteries as soon as possible after any sign they are getting weak.
- Never attempt to recharge batteries.

## ■ Using the AC Adaptor

Make sure that you use only the AC adaptor specified for this keyboard.

### Specified AC Adaptor: AD-5

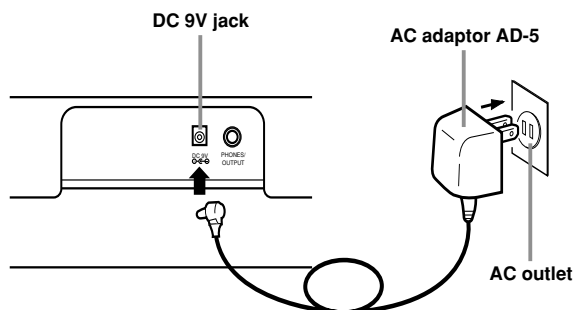

Also note the following important warnings and precautions when using the AC adaptor.

### Warning!

- Take care to avoid any damage to or breakage of the power cord. Never place any heavy objects on the power cord or expose it to direct heat. Doing so creates the danger of power cord damage, fire, and electrical shock.
- Use only the specified AC adaptor. Use of another type of adaptor creates the danger of fire and electrical shock.

---

---

### **Caution!**

- For safety sake, be sure to unplug the AC adaptor from the wall outlet whenever leaving the keyboard unattended for a long time (such as when leaving on a trip).
- Always turn off the keyboard and unplug the AC adaptor from the wall outlet when you are not using the keyboard.

### **Important!**

- Make sure that the keyboard is turned off before connecting or disconnecting the AC adaptor.
- Using the AC adaptor for a long time can cause it to become warm to the touch. This is normal and does not indicate malfunction.

## **■ Auto Power Off**

When you are using battery power, keyboard power turns off automatically whenever you leave it on without performing any operation for about 6 minutes. When this happens, move the POWER/MODE selector to the OFF position and then back to NORMAL, CASIO CHORD, or FINGERED to turn power back on.

### **Note**

- Auto Power Off is disabled (it does not function) when you are using the AC adaptor to power the keyboard.

## **■ Power On Alert**

Keyboard keys light to alert you if you leave power on and do not perform any operation for about 6 minutes. Note that keys light only, and no sound is produced. When this happens, press any button or keyboard key to clear the power on alert.

### **Note**

- Power on alert operates only when you are powering the keyboard using the AC adaptor. It does not operate when you are using batteries.

## **■ To disable Auto Power Off and power on alert**

Hold down the TONE button while turning on the keyboard to disable Auto Power Off and power on alert.

- When these functions are turned off, the keyboard does not turn off automatically and no alert is performed no matter how long it is left with no operation being performed.
- Auto Power Off and power on alert are enabled again when you manually turn off power and then turn it back on again.

## Basic Operations

This part of the manual provides you with the basic information you need to use your keyboard.

### ■ To switch power on and off



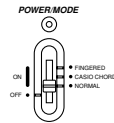





1. Set the **POWER/MODE selector** to NORMAL.



2. Press the keyboard keys.

3. The **VOLUME** up and down arrow buttons are used to adjust main volume.



- Pressing  or  displays the currently set volume setting. Press  or  again to change the volume setting.
- Volume can be adjusted over a range of 0 (minimum) to 9 (maximum).
- Volume is set to 7 when the power is turned on.
- A setting of 0 turns down the volume completely.
- The volume can be changed continuously by continuously pressing down the  or  buttons.
- Pressing the  and  buttons simultaneously sets the volume to level 7.
- Numeric values can be entered directly with the number buttons after the VOLUME button has been pressed in step 3.
- The amount that the volume settings raises or lowers the volume level differs according to the tone, auto accompaniment, or song you are using.

4. To switch power off, set the **POWER/MODE selector** to OFF position.

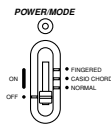

### ■ To change tones

1. Look at the tone list printed on the keyboard's console and find the one you want.
  - A total of 100 tones are available.

2. Press the **TONE button**.



- When you do, the TONE icon lights.
- The number for the tone that is currently selected is shown on the display.



TONE icon

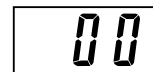

3. Use the **number buttons** to input the 2-digit number that identifies the tone you want to select.



- Always enter two digits for the tone number. If you enter only one digit, the display will automatically return to the previous tone number setting after a few seconds.
- If you change the tone setting while a keyboard key is depressed, the tone does not change until you release the key and press a keyboard key again.
- With certain tones (such as percussion sounds and sound effects), there may be very little or no change at all in the pitch, no matter which keyboard key you press.
- If you input the wrong first digit for a tone number, you can return to the previous setting by pressing the TONE button.



### Keyboard split tones

Some of the preset tones split the keyboard and assign two or more sounds. With such a preset tone, the sound produced depends on what position of the keyboard you play. For example, BASS/PIANO (tone 90) puts BASS on the left and PIANO on the right of the keyboard.

#### <Example>

BASS/PIANO (No.90)

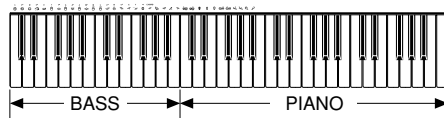

PERCUSSION (No.99)

- PERCUSSION (tone 99) assigns 35 percussion sound to the keyboard as illustrated below. The sound assigned to each key are indicated above the keyboard.

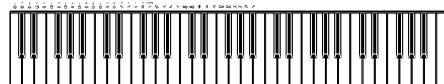

BASS DRUM	HIGH MID TOM	HIGH BONGO
SIDE STICK	CRASH CYMBAL 1	LOW BONGO
ACOUSTIC SNARE	HIGH TOM	MUTE HIGH CONGA
HAND CLAP	RIDE CYMBAL 1	OPEN HIGH CONGA
ELECTRIC SNARE	CHINESE CYMBAL	LOW CONGA
LOW FLOOR TOM	RIDE BELL	HIGH TIMBALES
CLOSED HI-HAT	TAMBOURINE	LOW TIMBALES
HIGH FLOOR TOM	SPLASH CYMBAL	HIGH AGOGO
PEDAL HI-HAT	COWBELL	LOW AGOGO
LOW TOM	CRASH CYMBAL 2	CABASA
OPEN HI-HAT	CLAVES	MARACAS
LOW MID TOM	RIDE CYMBAL 2	

E-18

475A-E-020A

- There are no sounds assigned to any keyboard keys from B4 onward when the “99 PERCUSSION” tone is selected.

## Digital Sampling

A number of the tones that are available with this keyboard have been recorded and processed using a technique called digital sampling. To ensure a high level of total quality, samples are taken in the low, mid, and high ranges and then combined to provide you with sounds that are amazingly close to the originals. You may notice very slight differences in volume or sound quality for some tones when you play them at different positions on the keyboard. This is an unavoidable result of multiple sampling, and it is not a sign of malfunction.

## Polyphony

The term polyphony refers to the maximum number of notes you can play at the same time. This keyboard has 12-note polyphony, which includes the notes you play as well as the rhythms and auto-accompaniment patterns that are played by the keyboard. This means that when a rhythm or auto-accompaniment pattern is being played by the keyboard, the number of notes (polyphony) available for keyboard play is reduced. Also note that some of the tones offer only 6-note polyphony.

- When rhythm or auto accompaniment is playing, the number of sounds simultaneously played is reduced.
- Though you can sound up to 12 notes at one time, only the last four keyboard keys pressed light up.

## ■ Other Useful Functions

### To change the key of the keyboard

The transpose feature of this keyboard lets you raise or lower its key in semitone increments. This means you can easily match to suit someone’s voice, and you can eliminate sharps and flats from music making it easier to play.

1. While in any mode besides the Song Bank Mode (indicated when the SONG BANK icon is lit), hold down the **TONE** button and press the **RHYTHM** button.

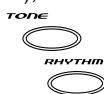

- Perform step 2 within five seconds after performing step 1.



2. Use the **TEMPO** buttons to change the key of the keyboard.



- Example: To change the tuning to B (indicated by -1 since it is one tone below C, which is the normal tuning of the keyboard).
- See page E-20 for the indicator that appears for each key.



Indicator remains on the display for a few seconds.

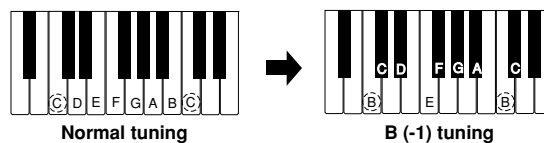

475A-E-021A

E-19

### <Keys and their indicators>

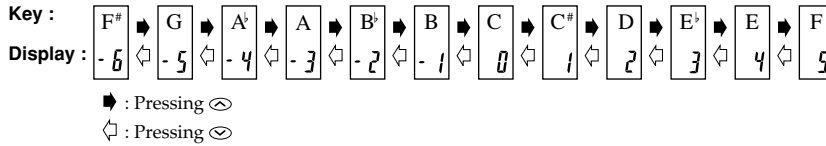

### <Note Names>



### Notes

- You cannot change the transpose setting while the keyboard is in the Song Bank Mode.
- In step 2 of the above operation, you could also use the number buttons [0] to [5] to specify C through F.
- Pressing both of the TEMPO buttons (⤴/⤵) at the same time returns the transpose setting to C(0).
- The transpose setting is automatically set to C(0) whenever you turn keyboard power on.
- The transpose setting is automatically set to C(0) whenever you press the SONG BANK button.
- The pitch of a transposed note depends on the tone you are using. If the transpose operation causes a note to exceed its upper range, the same note from the lowest octave available is substituted.
- The transpose operation does not affect tone number 99 (PERCUSSION) or auto-accompaniment rhythms.
- Transposing tones 75 through 79 and 90 through 96 changes the range of keys to which each of the tones is assigned.
- The transpose setting is automatically set to C(0) whenever you press the DEMO button.

## To tune the keyboard

A simple operation lets you tune the keyboard to another musical instrument.

1. While in any mode besides the Song Bank Mode (indicated when the SONG BANK icon is lit), hold down the **TONE** button and press the **SONG BANK** button.

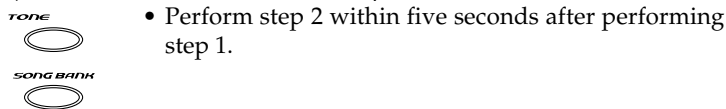

2. Use the **TEMPO** buttons to change the tuning of the keyboard.

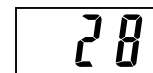
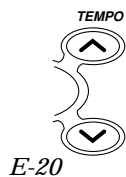

Indicator remains on the display for a few seconds.

475A-E-022A

## Notes

- In step 2 of the above procedure, you could also use the number buttons to input a value from 00 to 50.
- Pressing both of the TEMPO buttons (⌚/⌚) at the same time returns the tuning setting to 00.
- Pressing the SONG BANK button changes the tuning setting to 00.
- The tuning setting does not affect any of Song Bank tunes.
- You can tune the keyboard within a range of approximately  $\pm 50$  cents (100 cents = 1 semitone).
- The tuning setting is automatically set to 00 whenever you turn the keyboard on.
- Pressing the DEMO button changes the tuning setting to 00.
- The tuning operation does not affect rhythm (percussion).

## ■ Playing the demo tunes

You can set up the keyboard to continually play its 100 built-in Song Bank tunes. Keyboard keys light to indicate the melody notes of the demo tune as it plays.

### To start demo tune play

1. Switch power on and adjust the volume level.

2. Press the **DEMO button**.



- Demo tune play continues in a sequential endless loop until you switch it off.
- The number of the demo tune currently playing is shown on the display.
- You can play along on the keyboard while a demo tune is playing back.

3. You can change the demo tune play being played by pressing the **number buttons**.

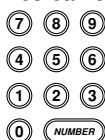

- The Song Bank tunes play back in tune number sequence, starting from the one you select.

### To stop demo tune play

Press the DEMO button again to stop demo tune play.



## Notes

- Only the following buttons are enabled while a Song Bank tune is being played.
  - VOLUME buttons
  - Number buttons
  - START/STOP button
  - POWER/MODE selector (OFF)
  - DEMO button
  - KEY LIGHT button
- You cannot change the tone being used for the melody of a Song Bank tune.

## ■ Playing rhythms

This keyboard features a collection of 100 exciting built-in rhythm patterns. Each pattern provides percussion back up for all your performances.

### To select and play a rhythm

1. Set the **POWER/MODE selector** to NORMAL.

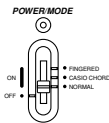

2. Find the rhythm you want to use in the "Rhythm List" (page A-3) and note its rhythm number.

3. Press the **RHYTHM button**.



- When you do, the RHYTHM icon lights.
- The number that appears on the display indicates the currently selected rhythm.



RHYTHM icon



4. Use the **number buttons** to input the 2-digit rhythm number for the rhythm you want to use.

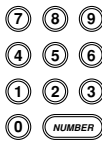

- Example: To select "71 SAMBA", input 7 and 1.
- Be sure to always specify a 2-digit number.
- If you discover a mistake before you input the second digit, press the RHYTHM button to return to the previously set rhythm number.
- You can change to another rhythm even while the current rhythm is sounding.

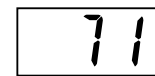

5. Press the **START/STOP button** to start play of the rhythm.

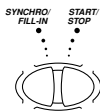

- When you do, the selected rhythm starts to sound.

6. Use the **TEMPO buttons** to adjust the tempo of the rhythm.



- Pressing ⏪ or ⏩ displays the current tempo setting. Press ⏪ or ⏩ again to change the tempo setting.
- Each time you press one of the TEMPO buttons while the tempo value is displayed, the tempo setting changes one step, within the range of 040 to 255.
- The initial default tempo setting when you turn on power is 120.
- After displaying the current tempo setting by pressing a TEMPO button in step 6, you can also input the tempo setting you want by inputting a three-digit value with the number buttons.

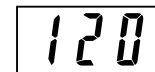



- Holding down either of the TEMPO buttons changes the tempo setting at high speed.
- To reset the tempo to the standard value of each rhythm, press both TEMPO buttons.

7. To stop rhythm play, press the **START/STOP** button again.

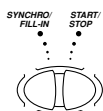

## ■ Using auto-accompaniment

This keyboard features 100 accompaniment patterns that let you add full accompaniments to your performances automatically. With auto-accompaniment, part of the keyboard is reserved as an accompaniment keyboard. As you play your chords on the accompaniment keyboard, the accompaniment patterns adjust automatically to follow the progression you play.

You get a choice between two different methods for chord play. FINGERED lets you play chords as you normally do, while CASIO CHORD makes it possible to play fully formed chords with one finger.

### About the accompaniment keyboard

The lower (left) 1.5 octaves are reserved for use as an accompaniment keyboard whenever you select CASIO CHORD or FINGERED with the POWER/MODE selector. The panel above the accompaniment keyboard keys is marked with the names of the notes they play. The remainder of the keyboard (the part that is not included in the accompaniment keyboard) is called the melody keyboard. Please be sure to remember these terms, because they will be used throughout the rest of this manual.

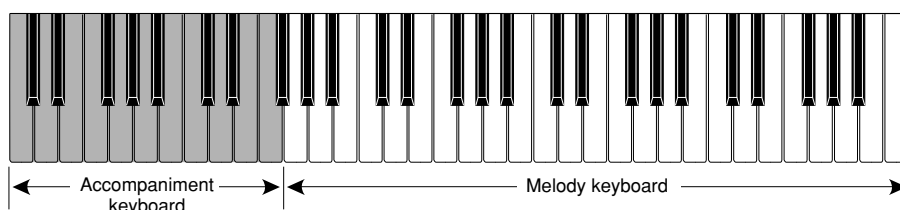

( The entire keyboard can be used for melody play while )  
the POWER/MODE selector is set to NORMAL.

## Using the CASIO CHORD system

The CASIO CHORD system lets you easily play the four main types of chords. Play of chords is simplified as shown in the chart below.

Keys	Chord Type	Example
Pressing <b>one</b> accompaniment key	Major chord	C (C Major Chord)
Pressing <b>two</b> accompaniment keys	Minor chord	Cm (C Minor Chord)
Pressing <b>three</b> accompaniment keys	Seventh chord	C7 (C Seventh Chord)
Pressing <b>four</b> accompaniment keys	Minor seventh chord	Cm7 (C Minor Seventh Chord)

### Notes

- The bottom (leftmost) note that you play determines the name of the chord. If the bottom note is a C for example, the keyboard produces a C chord.
- When pressing more than one accompaniment key, it makes no difference whether the keys to the right of the bottom note are white or black.

## To play a CASIO CHORD auto-accompaniment

1. Use the **POWER/MODE selector** to select CASIO CHORD.

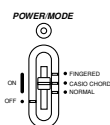

2. Select an auto-rhythm as described under "To select and play a rhythm" on page E-22.

3. Start play of the rhythm.

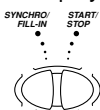

- If you want start play of the normal rhythm pattern, press START/STOP.
- You can also use synchro start (page E-27) to start rhythm play.

4. Press either one or up to four keys on the accompaniment keyboard, and the corresponding accompaniment starts to play automatically.
5. Continue pressing different keys on the accompaniment keyboard to play your chord progression.
6. To stop auto-accompaniment play, press the **START/STOP** button again.

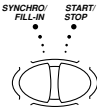

### Using standard fingerings

The FINGERED mode lets you play a wider variety of chords. In this mode, you can start play of an accompaniment pattern by pressing three or four of the accompaniment keyboard keys.

This keyboard is capable of recognizing 15 different chords. The following shows the fingerings of these chords with a root of C. Note that you can omit the fifth notes (which are shown inside parentheses in the illustrations below) to produce 7, m7, maj7, add9 and mM7 chords.

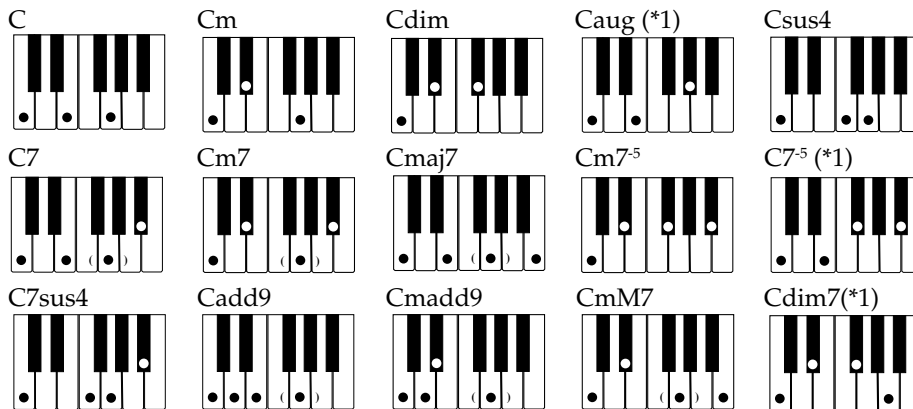

\*1 With this chords, the lowest note in your fingering is always used as the root. Make sure that your fingering correctly identifies the root you want to use.

### Important!

- If you play one or two notes only in the left hand, or three notes that do not make up a recognizable chord formation, no sound will be produced. FINGERED mode requires a conventional three or four-note chord formation to produce an auto-accompaniment. Also, note that auto-chords only work in conjunction with rhythm patterns, and not independently of them.

### Notes

- The above examples show only one of the possible fingerings for each chord. Note that you can play the notes that form a chord in any combination. Each of the following fingerings for example, produces the same C chord.

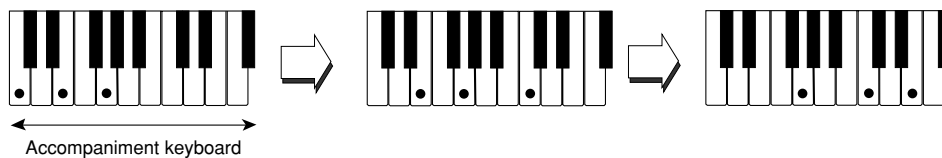

- See the "Fingered Chord Charts" on page A-1 for information on the fingerings of chords for all roots.

### To play a FINGERED auto-accompaniment

1. Use the **POWER/MODE selector** to select FINGERED.

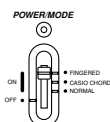

2. Select an auto-rhythm as described under "To select and play a rhythm" on page E-22.

3. Start play of the rhythm.

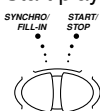

- If you want start play of the normal rhythm pattern, press **START/STOP**.
- You can also use synchro start (page E-27) to start rhythm play.

4. Play a chord on the accompaniment keyboard to start play of the auto-accompaniment.

5. Continue pressing keys on the accompaniment keyboard to play your chord progression.

6. To stop auto-accompaniment play, press the **START/STOP button** again.

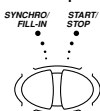

## ■ Improvising with the preset patterns

Pressing the **START/STOP** button to start rhythm play causes the normal version of the pattern to be played. You can also play a variation of the rhythm using the operation described below.

## ■ Using fill-in rhythm

You can insert a fill-in rhythm by pressing the **SYNCHRO/FILL-IN** button while an auto-rhythm plays.

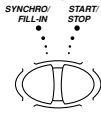

## ■ Using Synchro start

You can start the rhythm and accompaniment pattern at the same time, with your play of the accompaniment keyboard. To do this, follow the steps below.

1. Set the **POWER/MODE selector** to the **CASIO CHORD** or **FINGERED** position.

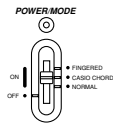

2. Select an auto-rhythm.
3. Press the **SYNCHRO/FILL-IN** button.

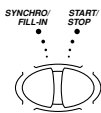

4. Press the accompaniment keys to play the first chord. As soon as you do, the auto-accompaniment pattern begins to play.

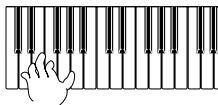

5. To stop the auto-accompaniment pattern play, press the **START/STOP** button.

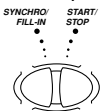

### Note

- If you set the **POWER/MODE** selector to **NORMAL** in step 1 on page E-22, the operation in step 4 starts play of the rhythm (percussion instruments) only.

## Three Step Lesson System

### ■ Using Three Step Lesson System

Even individuals who cannot play the keyboard at all can follow along with the 100 built-in Song Bank tunes with the ONE KEY PLAY buttons. You can also use the Three Step Lesson System to learn at your own pace. Play slowly at first until you are able to play along at normal speed.

Of the 100 built-in tunes, numbers 00 through 84 feature auto-accompaniment (auto-accompaniment tunes), while 85 through 99 are played using both hands (two-hand tunes).

The Three Step Lesson System can be used with the following three-step lesson plan to master keyboard play.

#### Step 1: Easy Play

Pressing the ONE KEY PLAY buttons plays the melody for an auto-accompaniment tune or the right hand part for two-hand tunes. In both cases, the auto-accompaniment (the right hand part in the case of two-hand tunes) is played automatically by the keyboard. In place of the ONE KEY PLAY buttons, you can also press any key of the keyboard to play the melody or right hand part. The purpose of this step is to familiarize yourself with the timing required to play melody notes.

#### Step 2: Slow Play

Press the keys that light as they teach you the correct notes to play. You can play at the pace you want, because the auto-accompaniment or left hand part waits until you press the correct key.

#### Step 3: Normal Play

At this level, the keyboard's keys still light to indicate which notes to play, but they no longer wait for you to press the correct key. The auto-accompaniment or left hand part is played at normal speed.

#### Notes

- You may not be able to see the keyboard keys light under direct sunlight or in other brightly lit areas.
- You can press the ONE KEY PLAY, STEP 1, STEP 2, and STEP 3 buttons at any time, except while a demo tune is playing. To return the keyboard to its normal mode, press the SONG BANK button.

## Three Step Lesson System Tempo Setting

You can use the procedure in step 6 of the procedure on page E-22 to set the tempo of the left-hand part for Song Bank and Three Step Lesson System play (Step 1 through 3).

This means you can use a slower tempo at the beginning, and then increase it as you learn. Press both of the TEMPO buttons (⊖ and ⊕) at the same time to return the tempo to its initial preset setting.

## To play a built-in Song Bank tune

1. Look up the number of the tune you want to play in the Song Bank list.

2. Press the **SONG BANK** button until the SONG BANK icon lights.



- The number that appears is the currently selected Song Bank number.



SONG BANK icon

3. Input the two digit number for the tune you want to play.

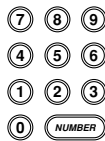

4. Press the **START/STOP** button to start play of the selected tune.

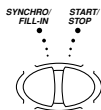

- The tune you select plays repeatedly, with the keyboard keys lighting to indicate the melody notes.

5. To stop Song Bank tune play, press the **START/STOP** button again.

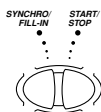

6. To exit the SONG Mode, press the **SONG BANK** button again.



- When you do, the SONG BANK icon goes out.
- At this time the tone number or rhythm number appears on the display.

## Notes

- Always enter two digits for the Song Bank number.
- You can input a Song Bank tune number even while another Song Bank tune is playing.
- If you input the wrong first digit for a Song Bank tune number, you can return to the previous setting by pressing the SONG BANK button.
- The RHYTHM button is disabled in the Song Bank Mode. If you want to play a rhythm, press the SONG BANK button to return to the normal mode first.

## Using the Three Step Lesson System with Song Bank Tunes

When you use a Song Bank tune with melody guide, the Three Step Lesson System teaches you which melody notes to play.

### Auto-accompaniment Song Bank Tune

Chord and melody part keys light.

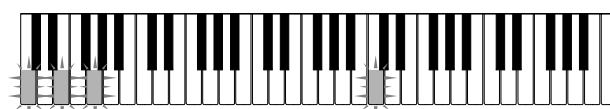

The root (the C-note of a C-chord) and other notes that make up the chord alternately light.

### Note

- Some Song Bank tunes use chords (such as C6) that cannot be played with the FINGERED setting (page E-25). In the FINGERED Mode, even if you finger the chords according to the keys that are lit by Melody Guide, chords may sound different from the ones produced during Melody Guide play.

### Two-hand Song Bank Tune

Left hand and right hand part keys light.

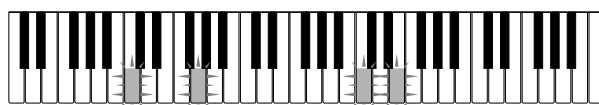



## How the Three Step Lesson System operates in Steps 1 through 3

When using an auto-accompaniment Song Bank tune with the Three Step Lesson System, the lights indicate not only the note you should play, but how long you should play it (how long you should keep the key depressed). The following describes what illumination of keys indicates.

- **Note Guide:** A lit key indicates the note to be played.
- **Length Guide:** Key remains lit for as long as note should be played.
- **Next Note Guide:** A flashing key indicates the next note to be played.
- **Consecutive Note Guide:** When a key lights, goes out momentarily, and then lights again, it indicates that the same note should be played in succession.

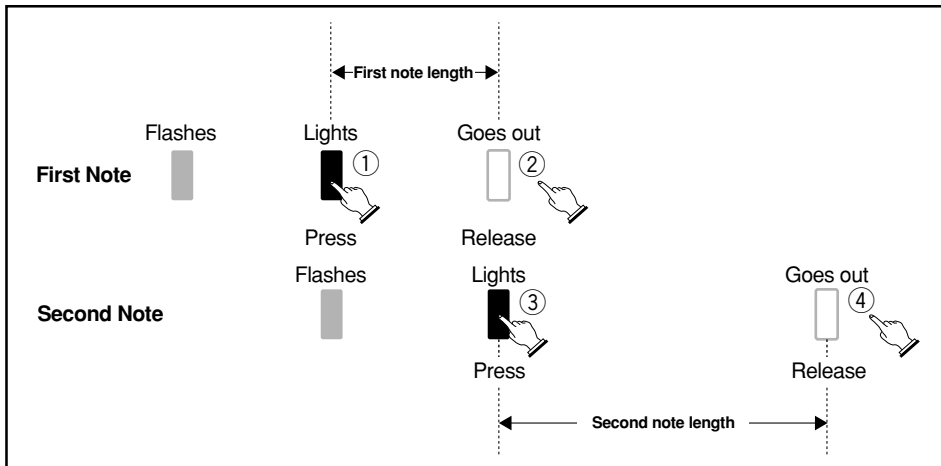

Note lengths are not indicated by the Three Step Lesson System when playing a two-hand tune with Step 1 and Step 2. The lit key goes out as soon as you press the correct keyboard key and the next note's key flashes.

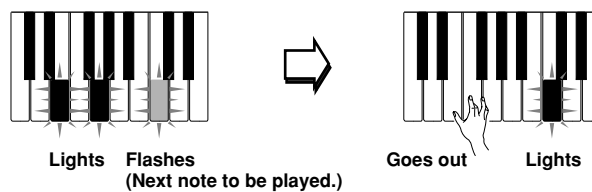

When playing a two-hand tune with Step 3, the applicable keyboard key remains lit as long as its note plays. In this case, however, the key for the next note to be played does not flash. Keys light when their notes start to play.

## Turning Off Key Lighting

1. Press the **KEY LIGHT** button.



- Press the KEY LIGHT button again to turn key lighting back on.

### Note

- Key lighting turns on automatically in any of the following cases:
  - When keyboard power is turned on.
  - When demo tune play is started.
  - When the SONG BANK button is pressed in the normal mode (page E-29 to steps 1 to 3).
  - When the power on alert function operates (page E-16).

## Number of Simultaneously Lit Keys

Up to four keyboard keys can be lit at the same time.

## To change the tone used for the melody of a Song Bank tune

1. Following step 3 of the procedure on page E-29, press the **TONE** button.



- Both the SONG BANK icon and TONE icon light, along with the tone number of the tone that is currently assigned to the keyboard.



2. Input a value to select the tone you want to use.

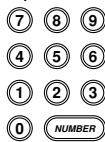

- Example: 30 VIOLIN

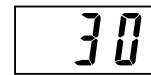

### Notes

- You cannot change the tone of the two-hand Song Bank tunes (number 85 through 99).
- Selecting another Song Bank tune switches the tone setting to the newly selected tune's preset melody tone.
- The tone assigned to the keyboard is the same one specified for the melody of the Song Bank tune.
- The above procedure can be used to change the Song Bank melody tone before starting play or while play is already in progress.

## ■ Step 1: Easy Play

You can press the ONE KEY PLAY buttons or any of the keyboard keys to play along with the melody (right hand part) of the Song Bank tune. You do not have to worry about pressing the right key, so you can concentrate on getting the timing right.

### 1. Press the **STEP 1** button.



- When you do, the STEP 1 icon lights.
- After a count sounds, the keyboard stands by and waits for you to play the first note of the tune. If the tune includes intro measures, the keyboard enters standby after the intro measures are complete.



STEP 1 icon

### 2. Press the **ONE KEY PLAY** buttons to play each note of the tune.



- The accompaniment (left hand) part of the tune follows along as you play the melody (right hand) part.
- The keyboard key that corresponds to the next note to be played flashes, and lights when you play the note.
- The rhythm (percussion) part does not sound.

### 3. Try pressing any one of the keyboard keys in place of the **ONE KEY PLAY** buttons.

- Pressing any keyboard key plays the correct melody (right hand part) note.
- Pressing more than one (up to four) keyboard keys plays the corresponding number of melody notes.

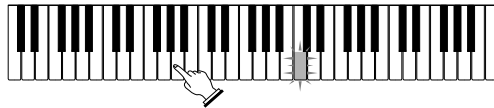

The correct note is played even if you do not press the key that is lit.

### 4. To interrupt an Easy Play session, press the **START/STOP** button.

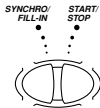

- When you do, the STEP 1 icon goes out.

## ■ Step 2: Slow Play

With Slow Play, you have to play the note that the Three Step Lesson System indicates. But don't worry - the accompaniment (left hand part) waits until you can play the correct note before continuing. This means you can take your time and play at your own pace.

### 1. Press the **STEP 2** button.

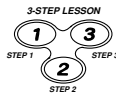

- When you do, the STEP 2 icon lights.
- After a count sounds, the keyboard stands by and waits for you to play the first note of the tune. If the tune includes intro measures, the keyboard enters standby after the intro measures are complete.



STEP 2 icon

2. Play the notes indicated by the Three Step Lesson System.
  - The accompaniment (left hand) part of the tune follows along as you play the melody (right hand) part.
  - The keyboard key that corresponds to the next note to be played flashes, and lights when you play the note.
  - The rhythm (percussion) part does not sound.

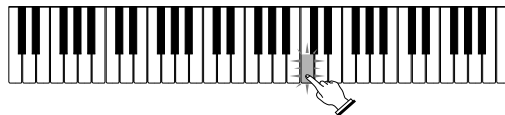

Press keyboard keys as they light. More than one key may light when you are playing a two-hand tune. Press all keys that light.

3. To interrupt an Slow Play session, press the **START/STOP** button.
  - When you do, the STEP 2 icon goes out.

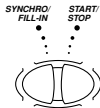

### ■ Step 3: Normal Play

Normal Play also shows you which notes to play, but unlike Slow Play, it does not wait for you to press the key. The accompaniment part is played at normal speed, no matter what you play (or don't play) on the keyboard.

1. Press the **STEP 3** button.
  - When you do, the STEP 3 icon lights.
  - Play starts after a count sounds.

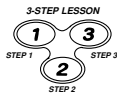

2. Play along on the keyboard, following the keys as they light.
  - The accompaniment (left hand) part of the tune plays at normal speed, regardless of what you play on the keyboard.
  - With a auto-accompaniment tune, the keyboard key that corresponds to the next note to be played flashes, and lights when the note should be played.
  - With a two-hand tune, the applicable keyboard key remains lit as long as its note plays. In this case, however, the key for the next note to be played does not flash. Keys light when their notes start to play.

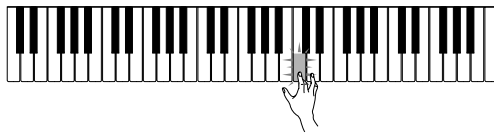

3. To interrupt a Normal Play session, press the **START/STOP** button.
  - When you do, the STEP 3 icon goes out.

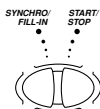

## ■ To practice the left hand part

Once you master right hand part play, you can use the two-hand tunes (numbers 85 through 99) to practice left hand part.

1. Press the **STEP 1**, **STEP 2**, or **STEP 3** button.



- When you do, the STEP 1, STEP 2, or STEP 3 icon lights.

2. Press the **PART SELECT** button to switch the left hand play.

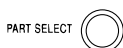

- After a count beat sounds, the right-hand part starts to play and the keys for the left-hand part notes flash.

3. Press the **PART SELECT** button to return the part selection to its previous setting.



4. To interrupt play of the melody, press the **START/STOP** button.

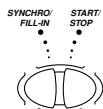

- When you do, the STEP 1, STEP 2, or STEP 3 icon goes out.

### Note

- The PART SELECT button is operational only while STEP 1, STEP 2, or STEP 3 is playing or paused (by the START/STOP button).

## To check if the right hand or left hand part is currently selected (two-hand tunes only)

The Three Step Lesson System tells you what part is selected whenever you press the STEP 3 button. Pressing the STEP 3 button causes the leftmost three keys to light when the left hand part is selected, and the rightmost three keys to light when the right hand part is selected.



## Technical Reference

### ■ Troubleshooting

Be sure to check the following table whenever you experience problems with keyboard operation.

Symptom	Cause	Action
<ul style="list-style-type: none"> <li>No sound when keyboard keys are pressed.</li> </ul>	<ol style="list-style-type: none"> <li>Power supply problem.</li> <li>Volume is set to 0.</li> <li>Headphones are plugged into the keyboard.</li> <li>The POWER/MODE selector is in the CASIO CHORD or FINGERED position.</li> <li>Tone "99 PERCUSSION" is selected and you are pressing keys that are not assigned tones.</li> </ol>	<ol style="list-style-type: none"> <li>Correctly attach the AC adaptor, make sure that batteries poles (+/-) are facing correctly, and check to make sure that batteries are not dead.</li> <li>Press the VOLUME  button.</li> <li>Unplug the headphones from the PHONES/OUTPUT jack.</li> <li>Normal play is not possible on the accompaniment keyboard while the POWER/MODE selector is set to CASIO CHORD or FINGERED. Change the POWER/MODE selector setting to NORMAL.</li> <li>While "99 PERCUSSION" is selected, you can use only keys to the left of B<sup>4</sup>. These keys are marked on the console with illustrations of percussion instruments.</li> </ol>
<ul style="list-style-type: none"> <li>Any of the following symptoms while using battery power. <ul style="list-style-type: none"> <li>Dim power supply indicator</li> <li>Instrument does not turn on</li> <li>Dim, difficult to read display</li> <li>Abnormally low speaker/headphone volume</li> <li>Distortion of sound output</li> <li>Occasional interruption of sound when playing at high volumes</li> <li>Sudden power failure when playing at high volumes</li> <li>Dimming of the display when playing at high volume</li> <li>Abnormal rhythm pattern and demo tune play</li> <li>Dimming of keyboard lights when notes sound</li> </ul> </li> </ul>	<ul style="list-style-type: none"> <li>Low battery power</li> </ul>	<ul style="list-style-type: none"> <li>Replace the batteries with a set of new ones or use the AC adaptor.</li> </ul>

E-36

475A-E-038A

Symptom	Cause	Action
<ul style="list-style-type: none"> <li>Keyboard keys remain lit.</li> </ul>	<ul style="list-style-type: none"> <li>Keyboard is standing by for keyboard play in Step 2.</li> </ul>	<ul style="list-style-type: none"> <li>Press the lit keys and continue with Step 2 play.</li> <li>Press the START/STOP button to stop Step 2.</li> </ul>
<ul style="list-style-type: none"> <li>Keyboard keys light but no sound is produced.</li> </ul>	<ul style="list-style-type: none"> <li>Power on alert is telling you that power is left on.</li> </ul>	<ul style="list-style-type: none"> <li>Press any button or keyboard key to resume normal operation with the keyboard in its initial power on setting.</li> </ul>
<ul style="list-style-type: none"> <li>RHYTHM button does not work.</li> </ul>	<ul style="list-style-type: none"> <li>Keyboard is in the Song Bank Mode.</li> </ul>	<ul style="list-style-type: none"> <li>Press the SONG BANK button to return to the Normal Mode.</li> </ul>
<ul style="list-style-type: none"> <li>Song Bank tone does not change.</li> </ul>	<ul style="list-style-type: none"> <li>A two-hand Song Bank tune (number 85 through 99) is selected.</li> </ul>	<ul style="list-style-type: none"> <li>Change to an auto accompaniment Song Bank tune (number 00 to 84). You cannot change the tone setting of a two-hand Song Bank tune (number 85 through 99).</li> </ul>
<ul style="list-style-type: none"> <li>Cannot change TRANSPOSE/TUNE settings.</li> </ul>	<ul style="list-style-type: none"> <li>Keyboard is in the Song Bank Mode.</li> <li>Demo tune play is in progress.</li> </ul>	<ul style="list-style-type: none"> <li>Press the SONG BANK button to return to the Normal Mode.</li> <li>Stop demo tune play.</li> </ul>
<ul style="list-style-type: none"> <li>Cannot play correctly even when the lit keyboard keys are pressed with Step 1.</li> </ul>	<ul style="list-style-type: none"> <li>More than one key is being pressed at the same time, which causes accompaniment to advance the corresponding number of notes (up to four).</li> </ul>	<ul style="list-style-type: none"> <li>When using Step 1, press keyboard keys one by one.</li> </ul>

## ■ Specifications

<b>Model:</b>	LK-35
<b>Keyboard:</b>	61 standard-size keys; 5 octaves
<b>Key Light System:</b>	Can be turned on and off (up to 4 keys can be lit at the same time)
<b>Tones:</b>	100 presets
<b>Polyphony:</b>	12 notes maximum
<b>Three Step Lesson System:</b>	Number of simultaneously lit keys; 4 Three steps Playback: 1 tune repeat playback
<b>Auto-accompaniment:</b>	Rhythm patterns 100 presets Tempo Adjustable, (216 steps, ♩ = 40 to 255), initial value: 120 Chords Two systems: CASIO CHORD, FINGERED Other Fill-in pattern, Synchro start
<b>Song Bank tunes:</b>	100 tunes
<b>Other Functions:</b>	Transpose (F <sup>#</sup> to C to F: half-note) Tuning Adjustable A4 = Approx. 440 Hz, ±50 cents, Initial value: A4 = Approx. 440 Hz
<b>Speakers:</b>	10 cm diameter x 2 (Output: 2W+2W)
<b>Digital Volume Control:</b>	Main volume; 10 steps (0 to 9), initial value: 7
<b>I/O Terminals:</b>	Power Supply DC 9V jack Headphones/Output Stereo standard jack (Output is monaural.) [output impedance: 78Ω, output voltage: 4V (RMS) MAX],
<b>Power Supply:</b>	2-way AC/DC power sources; Batteries 6 AA-size Battery life approximately 1 hour on R6P (SUM3) manganese batteries/ 4 hours on LR6 (AM3) alkaline batteries AC adaptor AD-5
<b>Auto Power Off:</b>	Approximately 6 minutes after the last operation (Operates during battery use only)
<b>Power Consumption:</b>	9 V --- 7.7 W
<b>Dimensions:</b>	94.4 x 36.3 x 11.8 cm (37 <sup>3</sup> / <sub>16</sub> " x 14 <sup>5</sup> / <sub>16</sub> " x 4 <sup>5</sup> / <sub>8</sub> ")
<b>Weight:</b>	Approximately 4.5 kg (9.9 lbs) (without batteries)

\* Designs and specifications are subject to change without notice.



# Appendix/Apéndice

## ■ Fingered Chord Charts ■ Cuadros de acordes digitados

475A-E-081A

Chord Type Root	M	m	7	m7	dim7	M7	m7-5	dim	aug	sus4
C										
C <sup>♯</sup> /(D <sup>♭</sup> )										
D										
(D <sup>♯</sup> )/E <sup>♭</sup>										
E										
F										
F <sup>♯</sup> /(G <sup>♭</sup> )										
G										
(G <sup>♯</sup> )/A <sup>♭</sup>										
A										
(A <sup>♯</sup> )/B <sup>♭</sup>										
B										

A-1

Chord Type Root	7sus4	m add9	mM7	7-5	add9
C					
C <sup>#</sup> /(D <sup>b</sup> )					
D					
(D <sup>b</sup> )/E <sup>b</sup>					
E					
F					
F <sup>#</sup> /(G <sup>b</sup> )					
G					
(G <sup>b</sup> )/A <sup>b</sup>					
A					
(A <sup>b</sup> )/B <sup>b</sup>					
B					

A-2

475A-E-082A

※ Cannot be specified in FINGERED setting because of accompaniment keyboard limitations, but augmented chords made up of the same component notes (with different base note) can be used instead.

Chords with same component notes as B<sup>b</sup> aug....D aug, F<sup>#</sup> aug

Chords with same component notes as B aug....E<sup>b</sup> aug, G aug

※ No puede especificarse en el ajuste FINGERED debido a las limitaciones del teclado de acompañamiento, pero en su lugar pueden usarse los acordes aumentados compuestos por las mismas notas componentes (con diferente nota básica).

Acordes con las mismas notas componentes como B<sup>b</sup> aumentada ... D aumentada, F<sup>#</sup> aumentada.

Acordes con las mismas notas componentes como B aumentada ... E<sup>b</sup> aumentada, G aumentada.

## ■ Rhythm List

## ■ Lista de ritmos

<b>POPS I</b>		32	HEAVY ROCK	66	FRENCH WALTZ	
00	CLUB POP	33	8 BEAT ROCK	67	SLOW WALTZ	
01	FUNKY POP 1	34	STRAIGHT ROCK	68	SERENADE	
02	RAP POP	35	HEAVY METAL	69	TANGO 1	
03	FUNKY POP 2	36	TWIST	<b>LATIN I</b>		
04	SOUL BALLAD	37	NEW ORLNS R&R	70	BOSSA NOVA	
05	POP BALLAD	38	CHICAGO BLUES	71	SAMBA	
06	LOVE BALLAD	39	R & B	72	MAMBO	
07	FUNKY POP 3	<b>JAZZ/FUSION</b>			73	RHUMBA
08	EPIC BALLAD	40	BIG BAND	74	CHA-CHA-CHA	
09	LITE POP	41	SLOW SWING	75	MERENGUE	
<b>POPS II</b>		42	SWING	76	REGGAE	
10	16 BEAT SHUFFLE	43	FOX TROT	77	BOLERO	
11	16 BEAT POP	44	JAZZ WALTZ	78	TANGO 2	
12	16 BEAT FUNK	45	MODERN JAZZ	79	LAMBADA	
13	8 BEAT POP	46	COOL	<b>LATIN II/VARIOUS I</b>		
14	8 BEAT SOUL	47	HARD BOP	80	PUNTA	
15	8 BEAT SHUFFLE	48	ACID JAZZ	81	CUMBIA	
16	DANCE POP 1	49	LATIN FUSION	82	SKA	
17	DANCE POP 2	<b>DANCE/FUNK</b>			83	TEX-MEX
18	POP FUSION	50	TECHNO POP	84	SALSA	
19	FOLKIE POP	51	RAVE	85	FOLKLORE	
<b>ROCK I</b>		52	CLUB GROOVE	86	PASODOBLE	
20	ROCK WALTZ	53	TECHNO	87	RUMBA CATALANA	
21	SLOW ROCK 1	54	TRANCE	88	SEVILLANA	
22	SLOW ROCK 2	55	HOUSE	89	FOLK	
23	SOFT ROCK 1	56	GROOVE SOUL	<b>VARIOUS II</b>		
24	SOFT ROCK 2	57	DISCO	90	COUNTRY	
25	SOFT ROCK 3	58	RAP	91	BLUEGRASS	
26	POP ROCK 1	59	FUNK	92	TOWNSHIP	
27	POP ROCK 2	<b>EUROPEAN</b>			93	FAST GOSPEL
28	50'S ROCK	60	POLKA 1	94	SLOW GOSPEL	
29	60'S SOUL	61	POLKA 2	95	ADANI	
<b>ROCK II</b>		62	MARCH 1	96	BALADI	
30	4 BEAT ROCK	63	MARCH 2	97	BAROQUE	
31	ROCK	64	WALTZ	98	ENKA	
		65	VIENNESE WALTZ	99	NEW AGE	

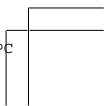
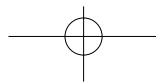
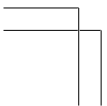
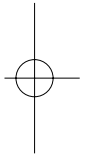
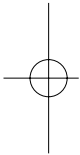
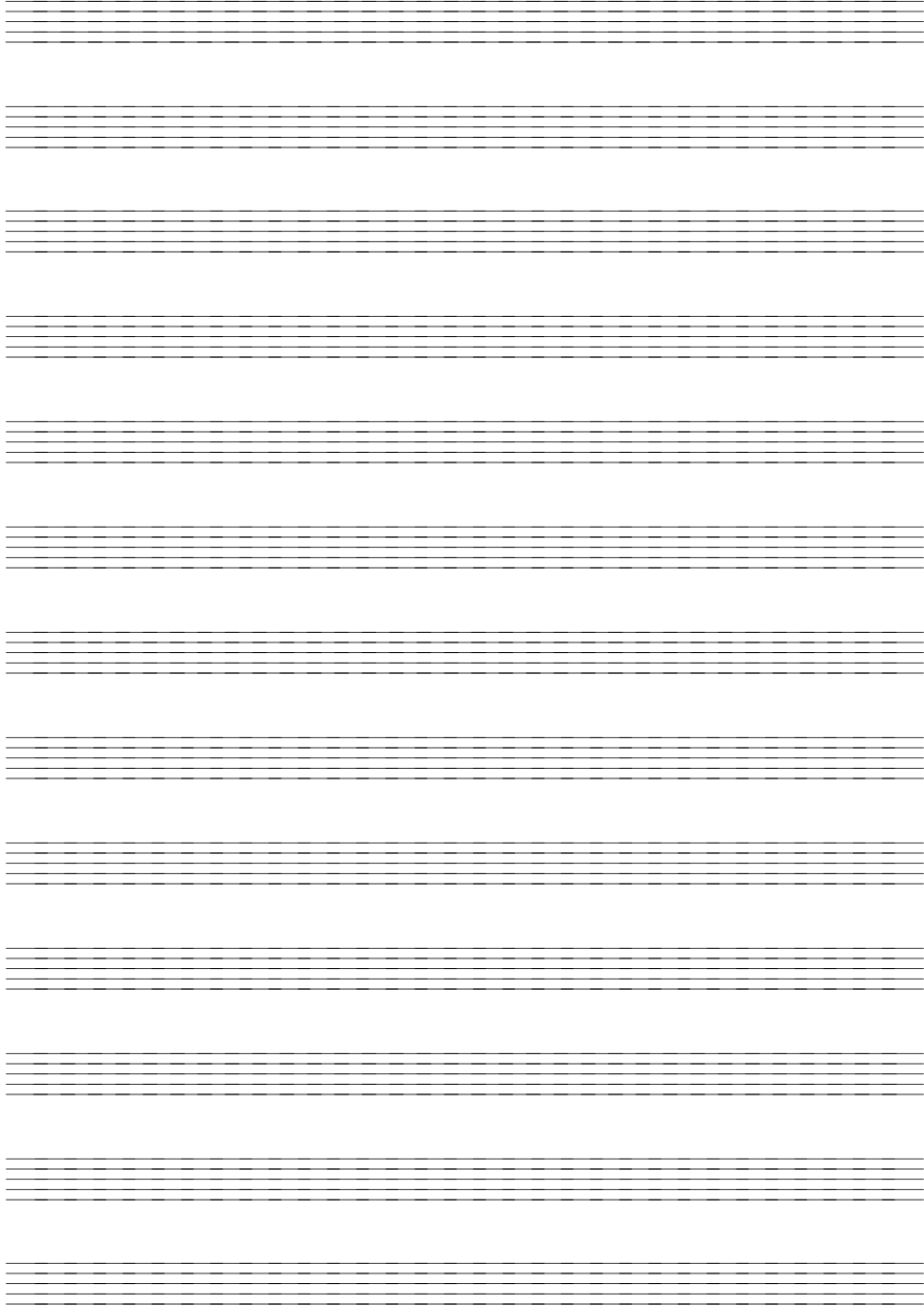
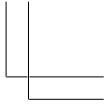
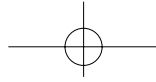
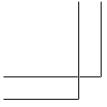

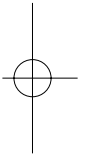
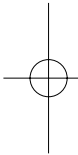
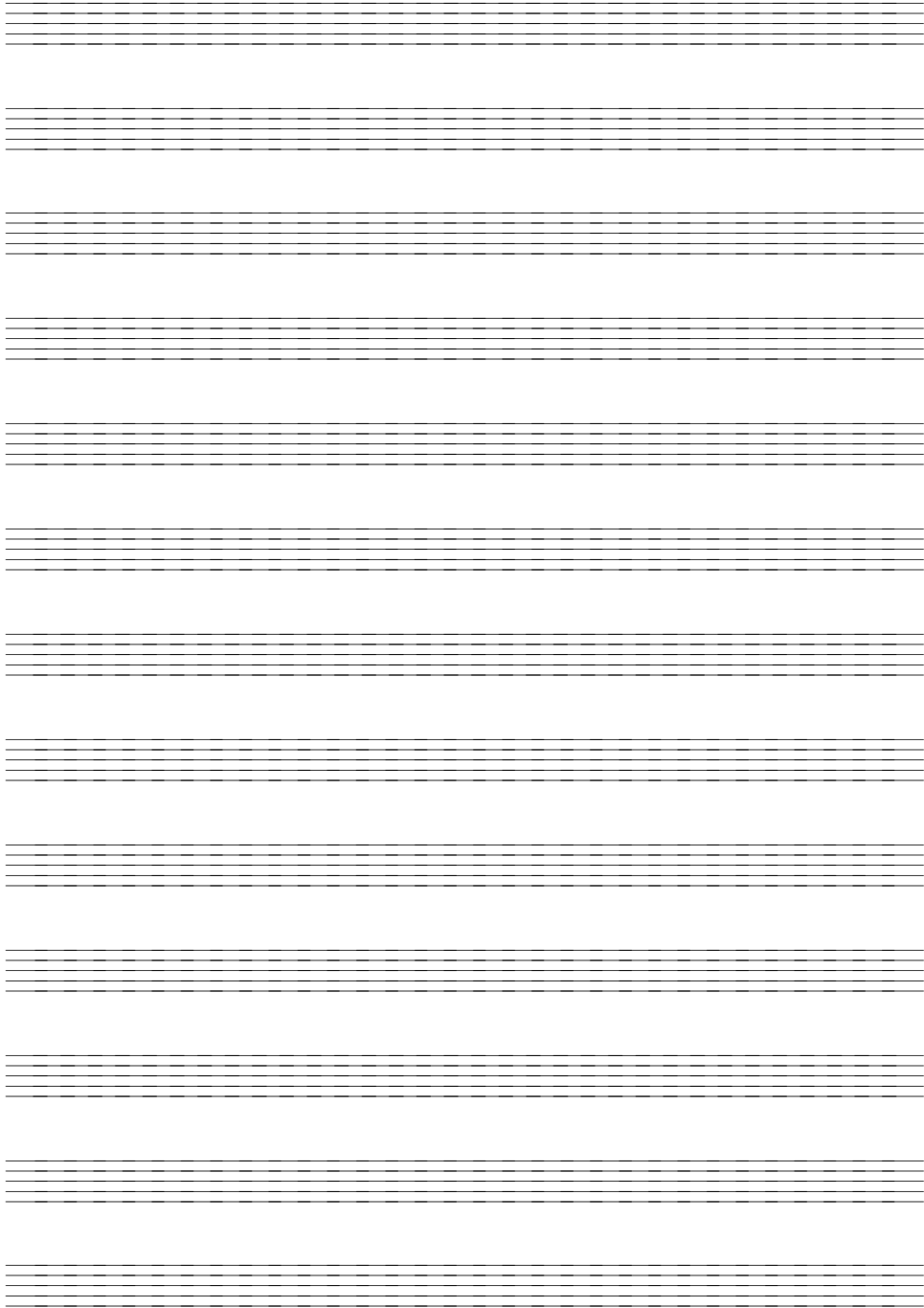
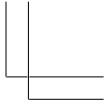
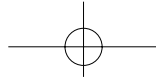
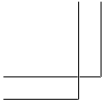

475A-E-085A

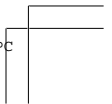
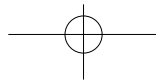
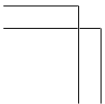

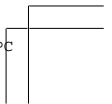
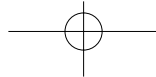
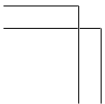
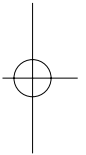
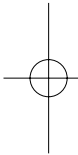
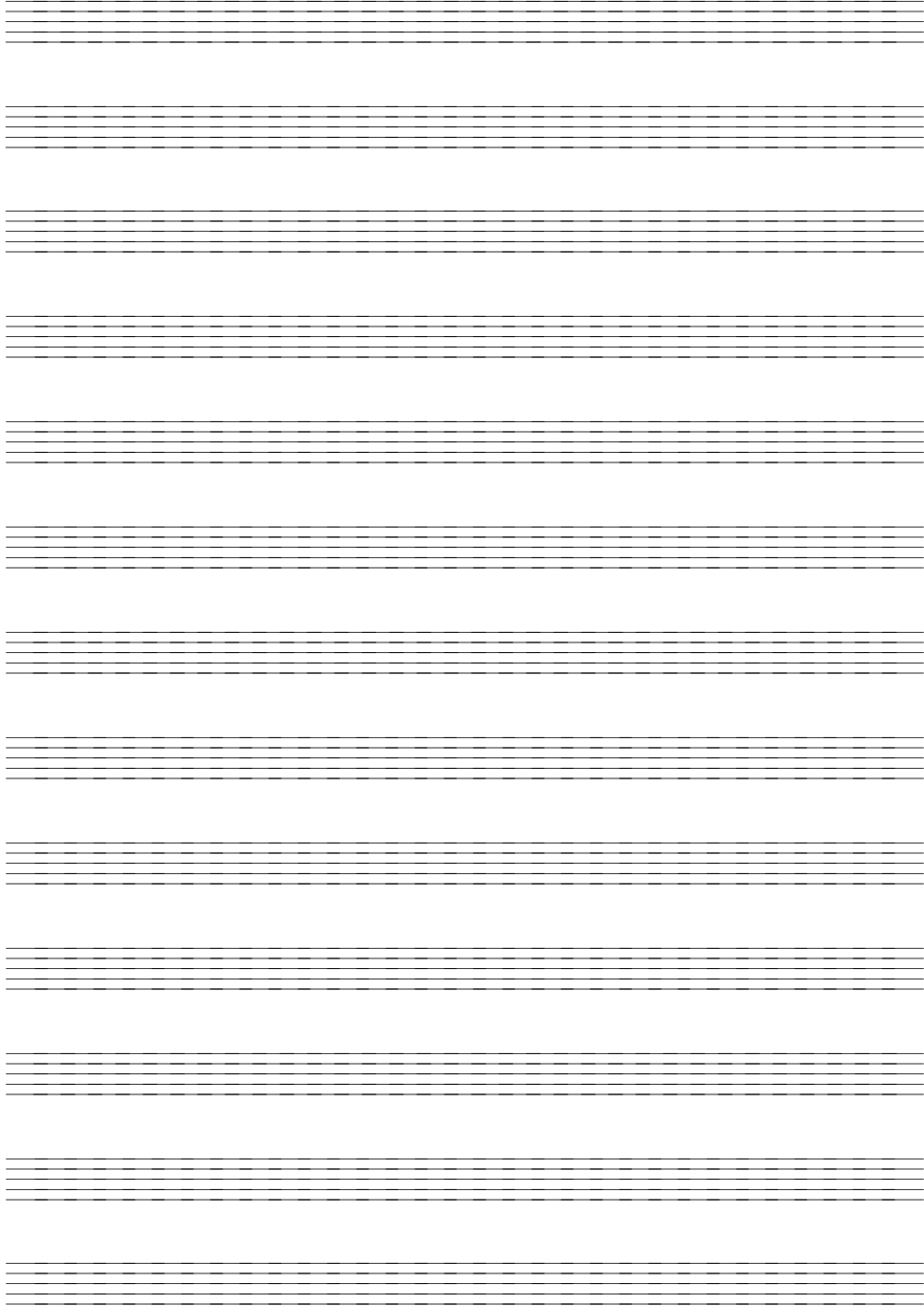
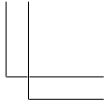
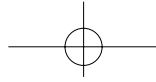
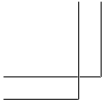

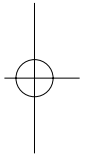
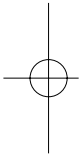
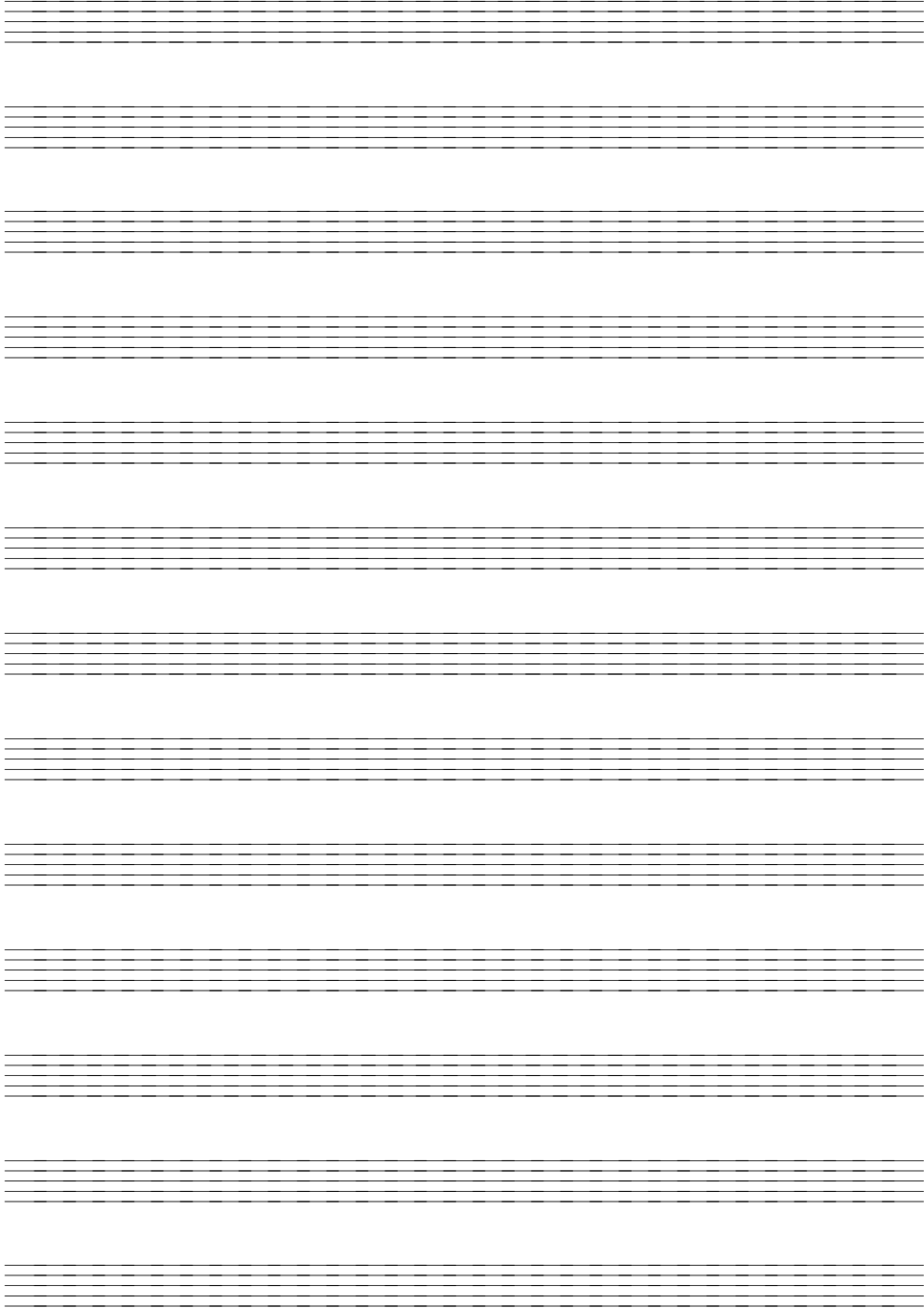
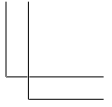
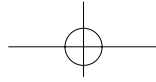
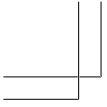

475A-E-087A

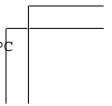
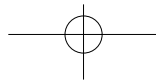
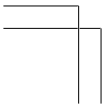



This recycle mark indicates that the packaging conforms to the environmental protection legislation in Germany.

Esta marca de reciclaje indica que el embalaje se ajusta a la legislación de protección ambiental en Alemania.

**CASIO®**

**CASIO COMPUTER CO.,LTD.**  
6-2, Hon-machi 1-chome  
Shibuya-ku, Tokyo 151-8543, Japan

P  
MA0005-A (英) (西) Printed in Malaysia  
LK35-ES-1



## Free Manuals Download Website

<http://myh66.com>

<http://usermanuals.us>

<http://www.somanuals.com>

<http://www.4manuals.cc>

<http://www.manual-lib.com>

<http://www.404manual.com>

<http://www.luxmanual.com>

<http://aubethermostatmanual.com>

Golf course search by state

<http://golfingnear.com>

Email search by domain

<http://emailbydomain.com>

Auto manuals search

<http://auto.somanuals.com>

TV manuals search

<http://tv.somanuals.com>