



Quick Start Guide & Installation manual
Guide de démarrage et Guide d'installation
Guía de inicio rápido y Manual de instalación

NX404

DVD MULTIMEDIA STATION WITH BUILT-IN NAVIGATION & 6.2" TOUCH PANEL CONTROL
Station multimédia DVD avec navigation intégrée et commande par écran tactile de 6.2 pouces
Estación multimedia DVD con navegación integrada y control de panel táctil de 6.2 pulgadas

CLARION PRODUCT REGISTRATION INFORMATION

For USA and Canada only

www.clarion.com

Dear Customer:

Congratulations on your purchase of a Clarion mobile electronic product. We are confident that you'll enjoy your Clarion experience.

There are many benefits to registering your product. We invite you to visit our website at www.clarion.com to register your Clarion product.

We have made product registration simple with our easy to use website.

The registration form is short and easy to complete. Once you're registered, we can keep you informed of important product information.

Register at www.clarion.com - it's easy to keep your Clarion product up to date.

INFORMATIONS DE L'ENREGISTREMENT DE PRODUITS CLARION

Pour les États Unis et le Canada seulement

www.clarion.com

Cher client:

Nous vous remercions d'avoir acheté ce produit électronique mobile Clarion. Nous sommes confiants que vous apprécierez votre expérience Clarion.

Il y a beaucoup d'avantage à enregistrer votre produits. Nous vous invitons à visiter notre site Web www.clarion.com pour enregistrer votre produit Clarion.

Nous avons facilité la tâche d'enregistrement de produit simple et facile grâce à notre site Web. Le formulaire d'enregistrement est court et facile à compléter. Lorsque vous êtes enregistrer, nous pouvons vous tenir informé des informations important de produits. Enregistrer à www.clarion.com - c'est facile de mettre à jour votre produit Clarion.

INFORMACIÓN DEL REGISTRO DE PRODUCTO DE CLARION

Para USA y Canada nomas

www.clarion.com

Querido Cliente:

Felicitaciones por su compra de producto electrónico móvil de Clarion. Estamos seguros que usted gozará de su experiencia con el producto de Clarion.

Hay muchas ventajas al registrar su producto. Le invitamos a que visite nuestro sitio en internet www.clarion.com para registrar su producto de Clarion.

Hemos hecho el registro de producto fácil en nuestro sitio. La forma de registro es corta y fácil de completar. Una vez que lo registre, podremos proporcionarle la información de su producto.

Regístrese en www.clarion.com - es fácil mantener su producto de Clarion actualizado.

Under Industry Canada regulations, this radio transmitter may only operate using an antenna of a type and maximum (or lesser) gain approved for the transmitter by Industry Canada. To reduce potential radio interference to other users, the antenna type and its gain should be so chosen that the equivalent isotropically radiated power (e.i.r.p.) is not more than that necessary for successful communication.

Conformément à la réglementation d'Industrie Canada, le présent émetteur radio peut fonctionner avec une antenne d'un type et d'un gain maximal (ou inférieur) approuvé pour l'émetteur par Industrie Canada. Dans le but de réduire les risques de brouillage radioélectrique à l'intention des autres utilisateurs, il faut choisir le type d'antenne et son gain de sorte que la puissance isotrope rayonnée équivalente (p.i.r.e.) ne dépasse pas l'intensité nécessaire à l'établissement d'une communication satisfaisante.

Contents

1. PRECAUTIONS.....	3
INFORMATION FOR USERS:	4
2. OPERATIONAL PANEL	6
Functions of Buttons.....	6
3. TURNING THE POWER ON	7
4. MAIN MENU.....	7
5. DVD VIDEO PLAYER OPERATIONS	8
Operate the DVD Player Menu.....	9
6. CD PLAYER OPERATIONS.....	10
Listening to a Disc/Ejecting a Disc	10
Showing CD Player Mode Screen	10
7. USB AUDIO OPERATIONS	11
8. USB VIDEO OPERATIONS.....	12
9. iPod/iPhone OPERATIONS	13
iPod Audio ID3 Information.....	13
iPod Audio Playlist Mode Screen	13
iPod Video ID3 Mode Screen.....	14
iPod Video Play Mode Screen	14
10. Pandora® OPERATIONS.....	15
Selecting the Pandora Mode	15
Selecting the Bluetooth Audio Mode.....	16
Bluetooth Audio Player Settings.....	16
11. Bluetooth® AUDIO PLAYER OPERATIONS.....	16
Pandora Bluetooth Mode.....	16
Registering your Bluetooth Audio Player (Pairing).....	17
Selecting the Bluetooth Audio Player	18
Controlling the Bluetooth Audio Player.....	18
Select the BT Phone Mode.....	19
Bluetooth Telephone Settings	19
12. Bluetooth® TELEPHONE OPERATIONS	19
Registering Your Cellular Phone (Pairing).....	20
Select the Cellular Phone.....	21
Obtaining the Phone Book Data	21
Telephone Operations	21
13. TUNER OPERATIONS.....	22

14. START USING Clarion MOBILE MAP.....	23
INSTALLATION	27
1. Before Starting.....	27
2. Package Contents	27
3. General Cautions	27
4. Cautions on Installation	27
5. Installing the Main Unit	28
Wire Connections	29
Installing The GPS Antenna	30

1. PRECAUTIONS



WARNING

- For your safety, the driver should not watch any video sources and/or operate the controls while driving. Please note that watching and operating any video sources while driving are prohibited by law in some countries. Also, while driving, keep the volume to a level at which external sounds can be heard.
- Do not disassemble or modify this unit. It may cause an accident, fire, or electric shock.
- Do not use this unit when a trouble exists, such as no screen content appears or no sound is audible. It may cause an accident, fire, or electric shock. For that case, consult your authorized dealer or a nearest Clarion service center.
- In case of a problem, such as any material has been entered in the unit, the unit gets wet, or smoke or strange smells come out of the unit, etc., stop using this unit immediately, and consult your authorized dealer or a nearest Clarion service center.
Using it in that condition may cause an accident, fire, or electric shock.
- Use a fuse with the same specification only when replacing the fuse. Using a fuse with a different specification may cause a fire.
- For the installation of this unit or a change in the installation, ask your authorized dealer or a nearest Clarion service center for safety. Professional skills and experiences are required to do so.
- This navigation system should not be used to replace your own judgment. No itinerary suggested by this navigation system should ever override any highway regulations, your own judgment, or a knowledge of safe driving practices. Do not follow the navigation system's suggested itinerary if it would cause you to perform a dangerous or illegal act, place you in a dangerous situation, or take you into an area you consider unsafe.
- The advice provided by the navigation system is to be regarded as a suggestion only. There may be times when the navigation system displays the vehicle's location incorrectly, fails to suggest the shortest route, or fails to direct you to your desired destination. In such instances, rely on your own driving judgment, taking into account the driving conditions at the time.
- Do not use the navigation system to locate emergency services. The database does not contain a complete listing of emergency services such as police stations, fire halls, hospitals and walk-in clinics. Please show discretion and ask for directions in such instances.
- As the driver, you alone are responsible for your driving safety.
- In order to avoid a traffic accident, do not operate the system while driving.
- In order to avoid a traffic accident, operate the system only when the vehicle is stopped at a safe place and the parking brake is on.
- In order to avoid a traffic accident or traffic offense, remember that actual road conditions and traffic regulations take precedence over the information contained on the navigation system.
- The software may contain inaccurate or incomplete information due to the passage of time, changing circumstances, and the sources of information used. Please respect current traffic conditions and regulations at all times while driving.
- Where actual road conditions and highway regulations differ from the information contained on the navigation system, abide by the highway regulations.
- Keep the amount of time spent viewing the screen while driving to a strict minimum.
- The navigation system does not provide, nor represent in any way information on: traffic and highway regulations; technical aspects of the vehicle including weight, height, width, load and speed limits; road conditions including grade, percentage of incline and surface conditions; obstacles such as the height and width of bridges and tunnels; and other current driving or road conditions. Always rely on your own judgment when driving a car, taking into account current driving conditions.
- This equipment has been tested and found to comply with the limits for a Class B digital device, pursuant to Part 15 of the FCC Rules.
These limits are designed to provide reasonable protection against harmful interference in a residential installation. This equipment

About the registered marks, etc.

- This product incorporates copyright protection technology that is protected by U.S. patents and other intellectual property rights. Use of this copyright protection technology must be authorized by Rovi Corporation, and is intended for home and other limited viewing uses only unless otherwise authorized by Rovi Corporation.
Reverse engineering or disassembly is prohibited.
- Manufactured under license from Dolby Laboratories. “Dolby” and the double-D symbol are trademarks of Dolby Laboratories.
- “Made for iPod,” and “Made for iPhone” mean that an electronic accessory has been designed to connect specifically to iPod, or iPhone, respectively, and has been certified by the developer to meet Apple performance standards. Apple is not responsible for the operation of this device or its compliance with safety and regulatory standards. Please note that the use of this accessory with iPod or iPhone may affect wireless performance.
iPhone and iPod are trademarks of Apple Inc., registered in the U.S. and other countries.



- The Bluetooth® word mark and logos are registered trademarks owned by the Bluetooth® SIG, Inc. And any use of such marks by Clarion Co.,Ltd. is under license. Other trademarks and trade names are those of their respective owners.
- Pandora. the Pandora logo. and the Pandora trade dress are trademarks or registered trademarks of Pandora Media. Inc. used with permission.

- DivX®, DivX Certified® and associated logos are trademarks of Rovi Corporation or its subsidiaries and are used under license. DivX Certified® to play DivX® video, including premium content. Covered by one or more of the following U.S. patents: 7,295,673; 7,460,668; 7,515,710; 7,519,274
ABOUT DivX VIDEO: DivX® is a digital video format created by DivX, LLC, a subsidiary of Rovi Corporation.
This is an official DivX Certified® device that has passed rigorous testing to verify that it plays DivX video. Visit divx.com for more information and software tools to convert your files into DivX videos.
ABOUT DivX VIDEO-ON-DEMAND: This DivX Certified® device must be registered in order to play purchased DivX Video-on-Demand (VOD) movies To obtain your registration code, locate the DivX VOD section in your device setup menu. Go to vod.divx.com for more information on how to complete your registration.

2. OPERATIONAL PANEL

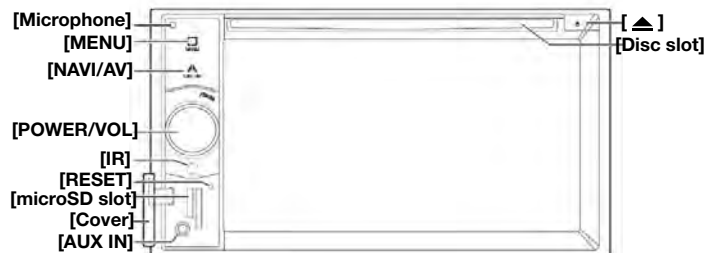

Only navigation map card is available and don't remove it when unit is power on

Functions of Buttons

[POWER/VOL] Knob

- Press this knob to turn on the power.
- When the power is already on, it moves to the Navigation mode. If Navigation mode is displayed, it moves to the Navigation menu.
- Keep pressing this knob more than 2 second to turn off the power.
- Turn this knob to left or right to decrease or increase the volume of the system.

[NAVI/AV] Button

- Press this button to display NAVI, press again to return current source.
- Press and hold this button for 2 seconds to display the Dimmer setting menu.

[▲] Eject

- Press to eject disc from unit.

[MENU] Button

- Press this button to display main menu; press again to return current source.
- Press and hold this button for 2 seconds to turn off the monitor. Press any place of the screen to turn on the monitor again.

[RESET] Button

- Press this button to hardware reset the unit.

Note: When the **[RESET]** button is pressed, frequencies of radio stations, titles, etc. stored in memory are cleared.

[microSD slot]

Insert a microSD Card for MAP here. The microSD card for MAP is sold separately. Note: The microSD card is only for navigation. Please don't insert microSD card for other purpose. After insertion of microSD card for MAP, don't remove it; otherwise, the navigation function will be disabled.

[AUX IN]

AUX 1 Connector.

[Microphone]

This is used for Bluetooth phone.

[IR] SENSOR

- Receiver for the remote control unit (operating range: 30 degree in all directions).

3. TURNING THE POWER ON



Start the engine. The power is supplied to this unit.

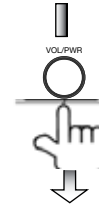

Press **[POWER]** button on the panel to turn on the unit.



Selecting a Source

- Press **[MENU]** button on the PANEL to show main source menu.
- Change page by dragging left or right or touching other buttons.
- Touch the icons on the screen to enter corresponding work mode, such as Disc mode, Tuner mode, Telephone mode, etc.

4. MAIN MENU

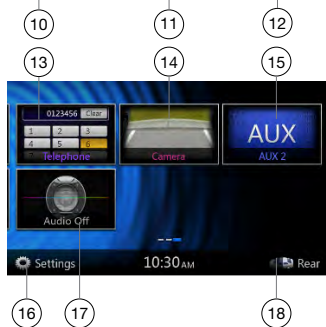
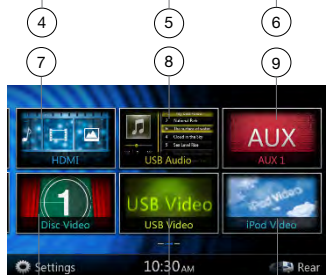
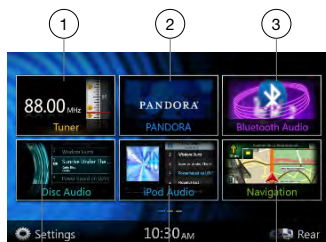

- 1 - Tuner---Touch the button to display the Tuner mode.
- 2 - Pandora---Touch the button to display the Pandora mode.
- 3 - Bluetooth Audio--- Touch the button to display the Bluetooth Audio mode.
- 4 - Disc Audio---Touch the button to display the Disc Audio mode.
- 5 - iPod Audio---Touch the button to display the iPod Audio mode.
- 6 - Navigation---Touch the button to display the Navigation mode.
- 7 - HDMI---Touch the button to display the HDMI mode.
- 8 - USB Audio---Touch the button to display the USB Audio mode.
- 9 - AUX1 ---Touch the button to display the AUX1 mode.
- 10 - Disc Video---Touch the button to display the Disc Video mode.
- 11 - USB Video---Touch the button to display the USB Video mode.
- 12 - iPod Video---Touch the button to display the iPod Video mode.
- 13 - Telephone--- Touch the button to display the Telephone mode.
- 14 - Camera---Touch the button to display the Camera mode.
- 15 - AUX2 ---Touch the button to display the AUX2 mode.
- 16 - Setting Button---Touch the button to display the Setting menu.
- 17 - Audio off---Touch the button to make audio source voice off.
- 18 - Rear---Touch the button to display the Rear mode.

Scrolling the menu

Flicking to right or left it will switch to next or previous page of main menu.

Moving the menu position

1. Touch any quadrate icon on main menu more than 2 seconds, the icon will float on main menu.
2. Scrolling the floating icon to any position you want.

5. DVD VIDEO PLAYER OPERATIONS

Showing DVD Player Mode Screen

After disc is loaded, the play mode is automatically engaged.

Touch any place of the screen to display DVD Video menu touch the screen again to return the playback screen. The display will return to the playback screen, if you do not touch the screen for 10 seconds.

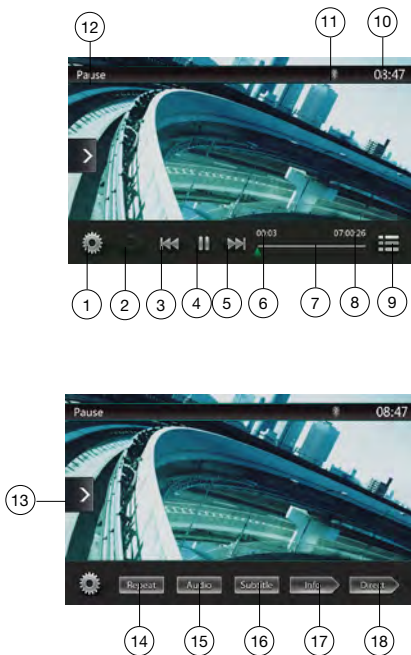

- 1 - Option button
- 2 - Show Cursor keys button
- 3 - Previous Chapter /Fast Backward button
- 4 - Play/Pause button
- 5 - Next Chapter /Fast Forward button
- 6 - Elapsed playing time
- 7 - Seek bar
- 8 - Total time
- 9 - Menu List button
- 10 - System time
- 11 - Bluetooth status indicator
- 12 - DVD playback information
- 13 - Shortcut button
- 14 - Repeat Switching button
- 15 - Audio Channel switching button
- 16 - Subtitle switching button
- 17 - Information button
- 18 - Direct chapter or title searching button



Operate the DVD Player Menu

Using the Title Menu

On DVD discs containing two or more titles, you can select from the title menu for playback.



1. Showing the DVD Video menu, touch [Cursor key] button during playback.
- * Depending on the disc, the title menu may not be called.

2. Touch the title menu screen. And touch the Show Cursor button.
3. Select the items in the title menu screen by  directional buttons.
- * Depending on the disc, items may not be selected with the directional buttons.
4. Touch  button to fix on the selected item.
5. Touch  button.

Showing Video Files Player Mode Screen



- 1 - Option button
- 2 - Previous Track /Fast Backward button
- 3 - Play/Pause button
- 4 - Next Track/Fast Forward button
- 5 - Elapsed playing time /Seek bar
- 6 - List Mode button
- 7 - System time
- 8 - Bluetooth status indicator
- 9 - Playback information

- 10 - Shortcut button
- 11 - Repeat button
- 12 - Audio button
- 13 - Subtitle button



6. CD PLAYER OPERATIONS

Showing CD Player Mode Screen

1. After disc is loaded, the play mode is automatically engaged.
2. If disc have been loaded you can touch **[Disc Audio]** button on main menu to display CD player mode screen.

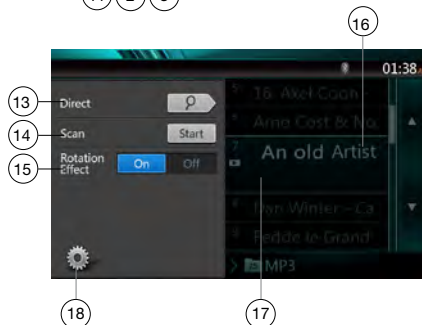
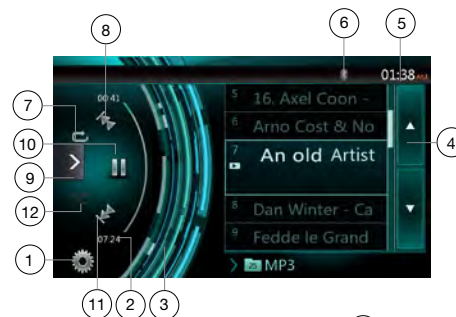

- 1 - Option button
- 2 - Elapsed playing time indicator
- 3 - Rotation effect
- 4 - Page turning button
- 5 - System time

- 6 - Bluetooth status indicator
- 7 - Repeat button
- 8 - Previous Track /Fast Backward button
- 9 - Shortcut button.
- 10 - Play/Pause button
- 11 - Next Track/Fast Forward button
- 12 - Shuffle button
- 13 - Direct Searching button
- 14 - Scan Start/Stop button
- 15 - Rotation Effect On/Off button
- 16 - Song title
- 17 - Artist/album information
- 18 - Close option menu button

Playback MP3/WMA/AAC Menu

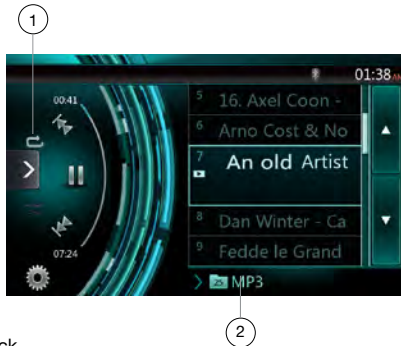

1. Repeat Playback

While playing MP3/WMA/AAC touch  button can switch between Repeat Folder, Repeat All and Repeat Track, Repeat Folder and Repeat All.

2. Current Folder

- Showing title of current folder.
- The number on the folder symbol is the number of files and folders number in current folder.
- Touch the title of current folder, play list will show files and folders in upper folder.

7. USB AUDIO OPERATIONS

This system can play audio files (MP3/WMA/AAC/FLAC) stored in an USB memory which is recognized as "USB Mass Storage Class device". You can use your USB memory as an audio device by simply copying desired audio files into it.

Note:

- This system will not operate or may operate improperly with some USB memory.
- Files protected with any DRM cannot be played.

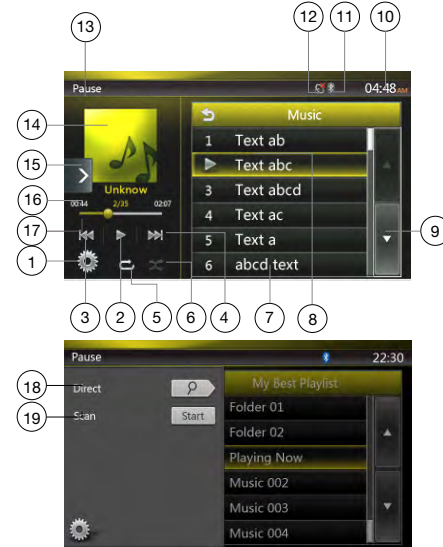

1. Option button
2. Play/Pause button
3. Previous Track /Fast Backward button
4. Next Track/Fast Forward button

5. Repeat button
6. Shuffle button
7. MP3 files, WMA files in list
8. Folders in list
9. Page turning button
10. System time
11. Bluetooth status indicator
12. Mute status indicator
13. Playback status information
14. Album art
15. Shortcut button
16. Current ID3 info area
17. Elapsed playing time indicator/Seek bar
18. Direct button
19. Scan button

8. USB VIDEO OPERATIONS

This system can play USB video files (MP4, 3GP etc.) stored in an USB memory which is recognized as "USB Mass Storage Class device". You can use your USB memory as an audio device by simply copying desired audio files into it.

Note:

- This system will not operate or may operate improperly with some USB memory.
- Files protected with any DRM cannot be played.

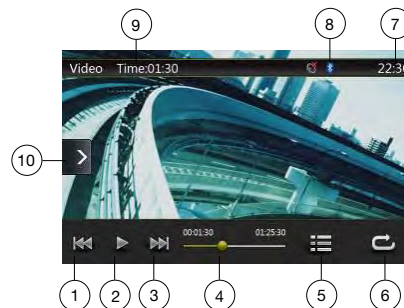

- 1 - Previous Track /Fast Backward button
- 2 - Play/Pause button
- 3 - Next Track/Fast Forward button
- 4 - Elapsed playing time indicator/Seek bar
- 5 - Menu list
- 6 - Repeat button
- 7 - System time
- 8 - Bluetooth status indicator
- 9 - Playback information
- 10 - Shortcut button

9. iPod/iPhone OPERATIONS

iPod Audio Menu Operations

Connect your iPod®/iPhone® to the USB connector. The system will automatically detect the connected device and the iPod Audio button will be enabled for operation on the Main Menu screen.

Note:

This system has two USB connectors, please connect to the USB with the label of "iPod/iPhone". By connecting another USB cable, iPod/iPhone can't play back the music.

iPod Audio ID3 Mode Screen

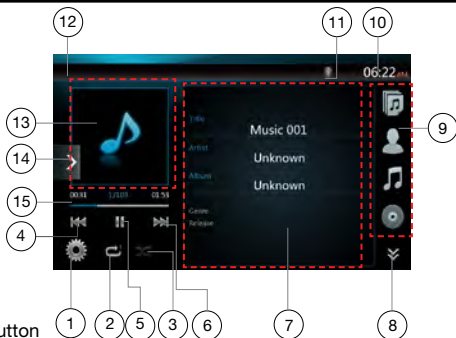

- 11 - Bluetooth status indicator
- 12 - Playback status indicator
- 13 - Art work
- 14 - Shortcut button
- 15 - Progress bar

iPod Audio Playlist Mode Screen



- 1 - Switch to information button
- 2 - Playing list
- 3 - Page turning button



- 4 - Back to father folder

- 1 - Option button
- 2 - Repeat button
- 3 - Shuffle button
- 4 - Previous Track /Fast Backward button
- 5 - Play/Pause button
- 6 - Next Track/Fast Forward button
- 7 - ID3 information
- 8 - Next Page[⏏] / Previous Page[⏏] button
- 9 - Category list
- 10 - System time

5 - Close the list mode

6 - Search with the first alphabet in current list

iPod Video ID3 Mode Screen

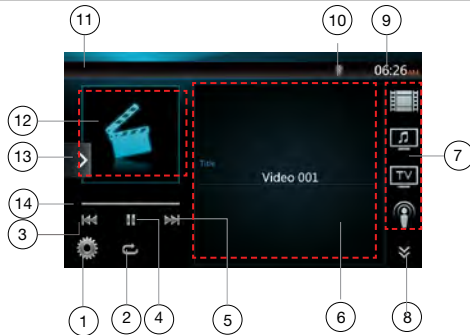

1 - Option button

2 - Repeat button

3 - Previous track button

4 - Play/Pause button

5 - Next track button

6 - Playing file title

7 - Category list

8 - Next Page[] / Previous Page[] button

9 - System time

10 - Bluetooth status indicator

11 - Playback status indicator

12 - Art work

13 - Shortcut button

14 - Progress bar

iPod Video Play Mode Screen



1 - Previous Track /Fast Backward button

2 - Play/Pause button

3 - Next Track/Fast Forward button

4 - Progress bar

5 - Menu list button

6 - Repeat button

7 - System time

8 - Bluetooth status indicator

9 - Playback information

10. Pandora® OPERATIONS

If you have any issues with the Pandora application on your mobile phone, please direct them to pandora-support@pandora.com.

Selecting the Pandora Mode

1. Turn on Pandora function of your iPod.
2. Connect your iPod to the unit.
3. When iPod/iPhone is already connected, touch the [Pandora] icon on the Main Menu screen.

- Pandora mode ID 3 Information Screen

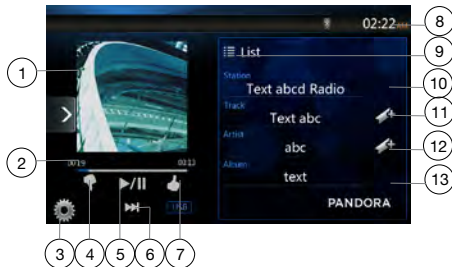

- 1 - Art work
- 2 - Progress bar
- 3 - Settings button
- 4 - Thumbs-down

Touch this button Thumbs-down current track and play next track.

- 5 - Play/Pause button

Use to control playback and pause.

(1). Touch the button during playback. Playback pauses.

(2). To resume playback touch the key again.

- 6 - Next track button

- 7 - Thumbs-up

- 8 - System time

- 9 - List button

Touch this button to show list screen

- 10 - Current station name

- 11 - Current title.

Touch icon to store current title to track favorites list.

- 12 - Current artist.

Touch icon to store current artist to artist favorites list.

- 13 - Current album name.

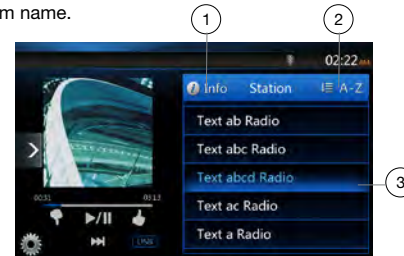

- 1 - [Info] button

Touch this button to display ID 3 Information Screen.

- 2 - [A-Z] button

Touch this button to sort the list by first letter, touch again to sort the list by date.

- 3 - Station list, touch to select station play.

When the desired station is not displayed, touch and flick the station list up or down.

- Pandora mode Setting screen

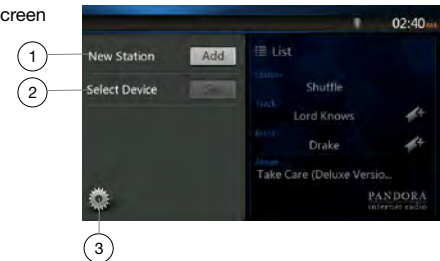

- 1 - Add a new Station
- 2 - Select a device
- 3 - Close the setting screen

Pandora Bluetooth Mode

When your mobile phone have connected to the unit via bluetooth. You can also enter the Pandora mode. The operation is same as the normal Pandora mode.



1

- 1 - BT mode

When connected via bluetooth. This icon will change from USB to BT

11. Bluetooth® AUDIO PLAYER OPERATIONS

Some Bluetooth cellular phones have audio features, and some portable audio players support the Bluetooth feature. These devices will be called as "Bluetooth audio players" in this manual. This system can play audio data stored in a Bluetooth audio player.

Note:

- This system will not operate or may operate improperly with some Bluetooth audio players.
- For detailed information on the playable Bluetooth audio players, see our home page: www.clarion.com

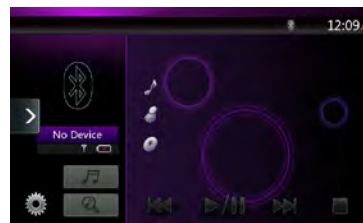

Selecting the Bluetooth Audio Mode

1. Touch the [Bluetooth Audio] key to select the Bluetooth Audio mode. The system changes to the Bluetooth mode. If the connection with a Bluetooth audio player has been already established, you may select the Music function.
2. Press MENU button on Operational Panel to return to the Main Menu.
 - When the connection with blue icon a Bluetooth audio player has been established, the  icon is displayed at the top of the screen.



Bluetooth Audio Player Settings

You can confirm various information concerning about the Bluetooth Interface features.

1. Touch the  button to display the information on the screen.
2. When you finish confirming the Bluetooth information, touch the  button to return to the previous screen.

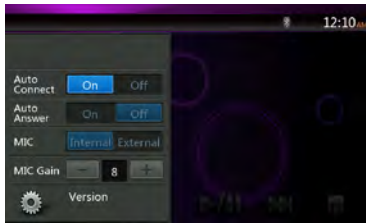

If you want to change the Pin Code setting of this unit, perform the following steps.

- The factory default setting is "1234".
3. Touch the text box of the Pin Code item to display the Ten-Key Pad screen.
 4. Enter your desired 4-digit PIN number, and then touch the **OK** button.

Registering your Bluetooth Audio Player (Pairing)

You can register up to 5 Bluetooth audio players.

1. Turn on the power of the Bluetooth audio player you wish to register.
2. Touch the Device button **[Bluetooth]** to display the Device Select screen.

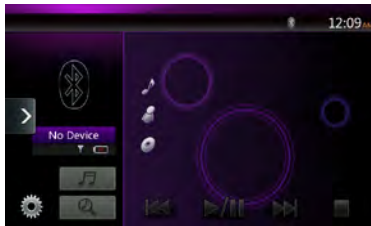

3. Touch the **[Inquiring]** button to display the Inquiring Device screen.

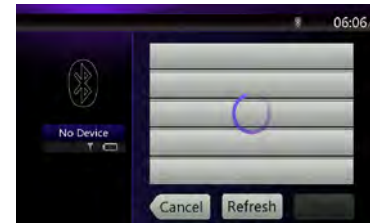

4. Touch your desired device button and touch **[Pair]** button to register for the Bluetooth audio player. Then select an image of this device.



And select a type of this device.



When the pairing operation completes, the registered Bluetooth audio player is set as the current device, after selecting the favorite icon, the display return to the device list screen. Touch **[Back]** button, the display will return to the Bluetooth audio mode screen.

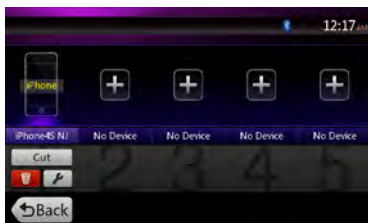

- To delete the Bluetooth audio player registration

1. Touch the button to delete the device. A confirmation screen is displayed.
2. Touch the button to confirm delete.

Selecting the Bluetooth Audio Player

To change the current Bluetooth audio player to the other device which is already registered, perform the following operation.

1. Touch the device button to display the Device Select screen.
2. Touch the currently connected device button, then touch the button to disconnect the active device.
3. Touch the desired Device button you wish to use. Touch button to select it as your active device. The corresponding cellular phone is set as current telephone.
4. Touch the button to return to the previous screen.

Controlling the Bluetooth Audio Player



Note:

- Occasionally, depending on the environment, playback sounds may be fragmented,

or switch noises may be generated.

Playing Music

After the connection with a Bluetooth audio player is established, the play mode is automatically engaged.

- When playback is not started for some devices, touch the button manually.

Pausing Playback

1. Touch the button during playback.

Playback Pauses.

2. To resume playback, touch the button. Playback resumes.

Skipping a Track (searching)

3. Touch the or button during playback.

Stopping Playback

4. Touch the button during playback. Tracks are stopped, touch the button to playback the first Track.

Show Track List

5. Touch the button to show the current track list. Touch the button to show all of the lists. And you can playback any tracks by touch the items in the list.

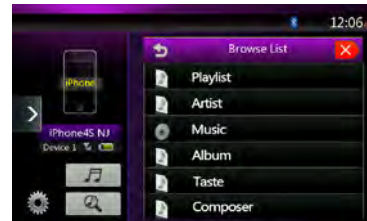
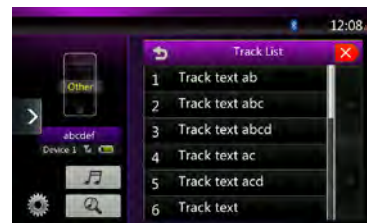

12. Bluetooth® TELEPHONE OPERATIONS

When the connection with your Bluetooth cellular phone is established, the following functions are available on this unit:

- Listening to your telephone calls on the car speakers.
- Answering to an incoming call.
- Making a call using the Ten-Key pad screen.
- Making a call using the Phone Book data in the selected cellular phone.
- Making a call using the History data of the dialed/received calls.

Note:

- Some cellular phones may not be able to transfer the Phone Book data to head unit.
- The Phone Book data transmission may take a long time. The operations of sending calls are disabled during the data transmission.

Select the BT Phone Mode

1. Touch the [Bluetooth Telephone] button to select the Bluetooth Telephone mode. The Telephone screen is displayed.
 2. Press MENU button on Operational Panel to return to the main menu.
- When no Bluetooth Telephone connected, the icon  is displayed at the top of the screen.

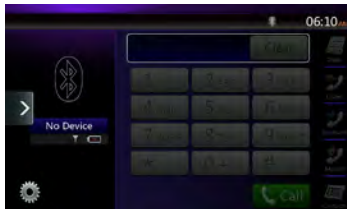



- When the connection with a Bluetooth Telephone has been established, the icon  and signal level indicator are displayed at the top of the screen.



Bluetooth Telephone Settings

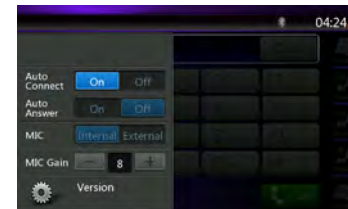

You can confirm various information concerning about the Bluetooth Interface features.

1. Touch the  button to display the information on the screen.
2. Perform setting for the desired item. See the following sections for detail.
3. When you finish confirming the Bluetooth information, touch the  button to return to the previous screen.



Setting Automatic Connection



The system automatically reconnects the cellular phone after the connection is lost or the system is restarted.

- The factory default setting is "ON". Touch the  or  button of the Automatic Connection item to set the function ON or OFF.

Note: The "auto-connect" is effective to the cellular-phone of last connecting.

Setting Automatic Answer

If a call comes in, answer automatically after 5 seconds.

- The factory default setting is "OFF". Touch the  or  button of the Automatic Answer item to set the function ON or OFF.

Setting Microphone Gain

You can adjust the input level of the microphone in 16 levels.

- Touch the level indicator button of the Microphone Gain item to adjust the input level.

Note:

- The input level of the microphone can be affected by its surroundings. Adjust the level if the person on the other end of the telephone has a reception problem.

Registering Your Cellular Phone (Pairing)

You can register up to 5 cellular phones. The registering method is as same as "Registering your Bluetooth audio player".

- Turn on the power of the cellular phone you wish to register.
- Touch the Device button  to display the Device Select screen.

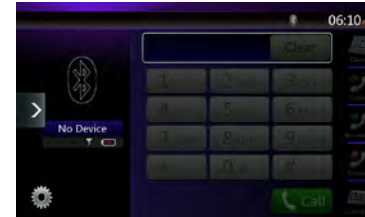

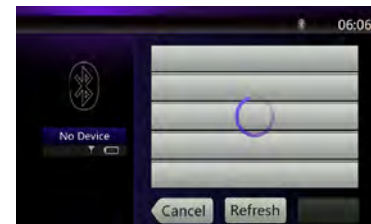

- Touch the  button to display the Inquiring Device screen.



4. Touch your desired Cellular button to select the button for the cellular phone to be registered, and touch  button to register for the Bluetooth cellular phone.
 - You cannot select the Cellular button of which another cellular phone is already registered. Select a blank Cellular button.
5. If entering the Pass Key code is prompted on your cellular phone, enter the Pass Key code set in this unit.
 - You can change the Pass key setting of this unit from the Bluetooth Info screen under the Telephone Settings screen.







When the pairing operation completes, the registered cellular phone is set as the current telephone, and the display returns to the Telephone screen.

- To delete the cellular phone registration
 1. Touch the  button to delete the device. A confirmation screen is displayed.
 2. Touch the  button to confirm delete.

Select the Cellular Phone

To change the current cellular phone to the other device which is already registered, perform the following operation.

1. Touch the  button to display the Device Select screen.
2. Touch the currently connected device, then touch  button to disconnect the active device.
3. Touch the desired Device button you wish to use. Touch  button to select it as your active device. The corresponding cellular phone is set as the current telephone.
 - If the power of the cellular phone is not turned on, turn it on.

- The cellular phone may prompt to acknowledge the Bluetooth connection or to enter the Pass Key code of this unit. Perform these operations according to the message displayed.
4. Touch the  button to return to the previous screen.

Obtaining the Phone Book Data

Sending the Phone Book data from the cellular phone enables you to make a call using the Phone Book function from this unit.

Telephone Operations

Making a call using the Ten-Key pad

1. Touch the  button to display the Ten-Key pad screen.
2. Enter the telephone number by using the Ten-Key pad displayed on the screen.

13. TUNER OPERATIONS

Listening to the Tuner

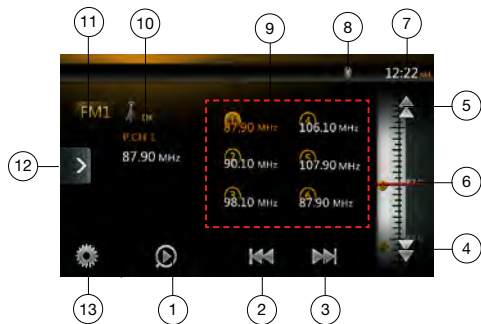

1. Preset Scan button
2. Seek down
3. Seek up
4. Step down
5. Step up
6. Frequencies display
7. System time
8. Bluetooth status indicator
9. Preset list
10. DX/Local indicator
11. Band button
12. Shortcut button
13. Option button

Auto Store

The Auto Store is a function for storing up to 6 stations that are automatically searched in sequentially. If the number of receivable stations cannot reach to 6, the previous stored station remains.

1. Touch the **[FM1/2/3/AM]** button to select the desired band. (FM or AM)
2. Touch the **[📶]** button, and then press the **[Start]** button to start the Auto Store. A beep sounds and the stations with good reception are stored automatically to the preset list.

Notes:

1. After auto store, the previous stored stations will be overwritten.
2. The unit has 4 bands, but FM3 and AM can store by AS function.

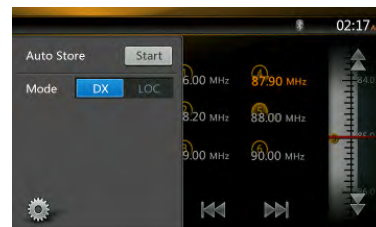

Preset Scan

The Preset Scan receives the stations stored in the preset memory in order. This function is useful when searching for the desired station in memory.

1. Touch the **[FM1/2/3/AM]** Button to select the desired band. (FM or AM)
2. Touch the **[📶]** button to start the Preset Scan. The unit starts scanning each station for 10 seconds sequentially. But the station stored is not a valid station; the scanning time is only 2 seconds.
3. When the desired station is tuned in, touch the **[📶]** button again to stay in that station.

DX/Local Setting

The DX / Local setting changes the tuner sensitivity in order to separate closely spaced stations. This feature is useful in areas that have many radio stations in close proximity.





14. START USING Clarion MOBILE MAP

When Clarion Mobile Map is started the first time, you need to do the following:

1. Select the written language of the application interface. Later you can change it in Settings.
 2. Select the language and speaker used for voice guidance messages. Later you can change it in Settings.
 3. Read and accept the End User License Agreement.
 4. Read and accept the road safety warning.
- After this, the Navigation menu appears and you can start using Clarion Mobile Map.

Selecting the destination of a route

To enter an address as the destination, do as follows:

1. If you are on the Map screen, tap  to return to the Navigation menu.
2. In the Navigation menu, tap the following buttons:  
3. Selecting a destination by entering the address or the postal code. 
4. Selecting the destination from the Places of Interest.
5. Selecting a map location as the destination.
6. Selecting the destination from your Favorite.
7. Selecting your Home location.
8. Searching for a Place of Interest by its phone number.
9. Entering the coordinate of the destination.
10. Selecting a recent destination from the History.
11. Additional options.

• For the information about other ways, see the user manual.

Map screen

12. To enlarge this small map and open the Map screen, tap [Show Map] button.
13. Zooming in and out.
14. Tilting up and down.
15. Rotating left and right.
16. 2D or 3D view.
17. Location information.

18. Return to normal navigation.
19. Select destination.

Quick menu

20. The Quick menu is a selection of controls and functions that are frequently needed during navigation. It can be opened directly from the Map screen by tapping 
21. If more drivers use Clarion Mobile Map for navigating, their settings can be remembered by using one of the user profiles.
22. Find / Find Places / Quick Search (This function lets you search for a Place along your route or around your current location if there is no route calculated).
23. Find / Favorite (This button opens the list of your Favorite destinations).
24. Find / History (This button opens the History list. You can select one of your previous destinations).
25. More / Settings / Route Settings (This button opens the route related settings).
26. More / Settings / Map Settings (This button opens the map related settings).
27. Tap the Current Street field on the Map screen (This button opens a special screen with information about the current position and a button to search for nearby emergency or roadside assistance).
28. My Route / Cancel Route (This button cancels the route and stops navigation. The button is replaced with the next one if waypoints are given).



TMC icon is not available on NX404

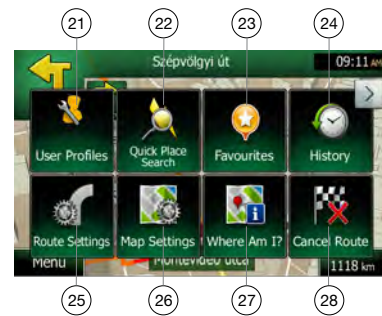
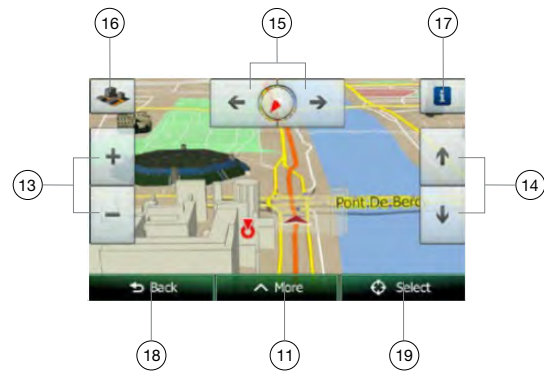

Symbol Identification

This manual uses symbols and icons to indicate safety precautions and concerns during the installation procedure. Be sure to carefully read and understand each precaution prior to beginning the installation.

WARNING

This symbol is intended to alert the user to the presence of important operating instructions. Failure to heed the instructions may result in severe injury or death.

CAUTION

This symbol is intended to alert the user to the presence of important operating instructions. Failure to heed the instructions can result in injury or material damage.

WARNING

- Confirm the battery voltage of the vehicle to be installed. This unit is designed only for vehicles with DC 12V power supply.
- Disconnect the negative terminal of the battery before connecting wires, otherwise an electric shock, injury by short circuit may occur.

Installation Precautions

WARNING

- When installing the unit to a vehicle with an airbag system, never install it in a place where it may affect the operation of the airbag.
- Do not install this unit in the following locations:
 - A location interfering with the driver's visual range or operation.
 - A location where the gear shift or brake pedal are hindered.
 - A location where passengers are at risk.
 - An unstable location, or where the system may fall.

CAUTION

- Do not install the system in the locations described below. This may cause a fire, accident or electrical shock:
 - A location exposed to rain or dust.
 - An unstable location, or where the system may fall.
- Do not install this unit in a place exposed to direct sunlight, heat or a place where the vent holes or heat radiation holes are covered.
- When you install the antenna, mount it in a place where the elements of the antenna do not protrude beyond the edge of the front, back, left and right of the vehicle. If it comes in contact with pedestrians, it may cause an accident.

Installation Notes

⚠ WARNING

- Please note the position of pipes, tanks and electrical wirings before installing the unit into the vehicle; failure in avoiding these may cause a fire or malfunction.

⚠ CAUTION

- Use only the supplied parts.
If unspecified parts are used, they may cause damage.
- Any holes made in the body of the vehicle should be sealed with a silicon adhesive. If exhaust fumes or water penetrates into the vehicle, this may cause an accident.
- Fasten the bolts securely when installing the unit. If the bolts are loose an accident or malfunction could occur.

⚠ CAUTION

- Verify wires with a digital multi-meter prior to making any connections. Many new vehicles use multiplexed and/or low voltage circuits that can be damaged if a test light or logic probe is used.
- Connect cables appropriately. If a wrong connection is made, this may cause a fire or accident.
- When passing cables through the body of the vehicle, use non-conductive grommets. If the coatings of the cables are worn out by rubbing, this may cause an accident, fire or a short circuit.
- After wiring cables, fix them with insulation tape.
- Be sure to switch off the vehicle when connecting or disconnecting cords to/from the unit, otherwise an electric shock, injury or accident may occur.

Connection Notes

⚠ WARNING

- Loom all cables according to the instruction manual, so as not to hinder operation.
- Wire the connecting cords/cables away from high temperature areas. If the coatings of the cables melt, it could cause an accident/fire by a short circuit. Take care when wiring in the engine compartment.
- When wiring the connecting cables in a vehicle with an airbag system, never feed the cables through a place where it may affect the operation of the airbag. An airbag not operating correctly in an emergency may cause increased injury.

INSTALLATION

CONTENTS

1. Before Starting.....	27
2. Package Contents	27
3. General Cautions.....	27
4. Cautions On Installation.....	27
5. Installing The Main Unit.....	28

1. Before Starting

1. This set is exclusively for use in cars with a negative ground 12 V power supply.
2. Read these instructions carefully.
3. Be sure to disconnect the battery “-” terminal before starting. This is to prevent short circuits during installation. (Figure 1)

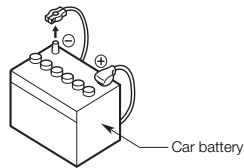

Figure 1

2. Package Contents

Main unit	1
Wiring harness	1
GPS antenna	1
Clamp for GPS antenna's cable	3
Double face tape for GPS Antenna.....	1
Owner's manual (CD-R)	1

Quick Start Guide and

Installation manual.....	1
Warranty card.....	1
Remote controller	1
HDMI cable holder.....	1
Machine screw(M2 x 4).....	2
RCA output cable.....	1
Electro tap.....	2
Flush mount bolts	8
Hexagon Head Screw.....	8
AV cable	1
SWI cable	1

3. General Cautions

1. Do not open the case. There are no user- serviceable parts inside. If you drop anything into the unit during installation, consult your dealer or an authorized Clarion service center.
2. Use a soft, dry cloth to clean the case. Never use a rough cloth, thinner, benzene, or alcohol etc. For tough dirt, apply a little cold or warm water to a soft cloth and wipe off the dirt gently.

4. Cautions on Installation

1. Prepare all articles necessary for installing the source unit before starting.
2. Install the unit within 30° of the horizontal plane. (Figure 2)
3. If you have to do any work on the car body, such as drilling holes, consult your car dealer beforehand.
4. Use the enclosed screws for installation. Using other screws can cause damage. (Figure 3)

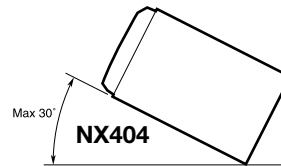

Figure 2

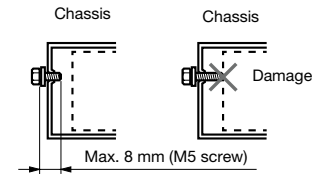
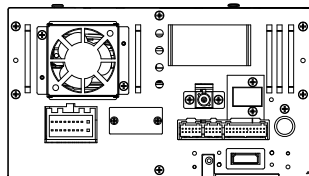

Figure 3

5. This unit has a fan motor in the back of the main unit so as not to raise the temperature in the source unit. When the fan motor vent is covered with cords or mounting bracket, it may cause a malfunction. Be sure not to cover it when wiring cords.



5. Installing the Main Unit

This unit is designed for fixed installation in the dashboard.

1. When installing the main unit in NISSAN vehicles, use the parts attached to the unit and follow the instructions in Figure 5.

When installing the main unit in TOYOTA vehicles, use the parts attached to the vehicle and follow the instructions in Figure 6.

2. Wire as shown in Section 7.
3. Reassemble and secure the unit in the dashboard and set the face panel and center panel

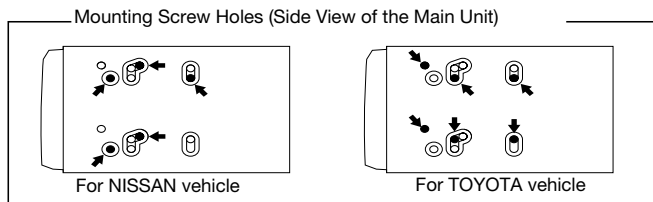

Figure 4

Installing the Main Unit in NISSAN Vehicle

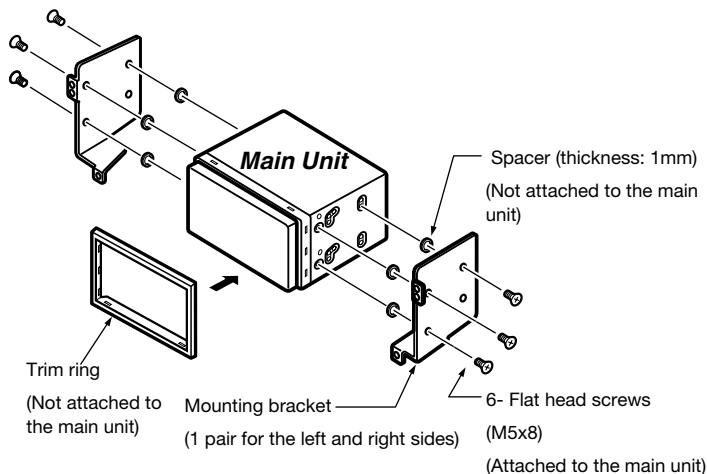

Figure 5

Vehicles other than NISSAN and TOYOTA

In some cases the center panel may require modification. (Trimming, filing, etc.)

• Removing the Main Unit

When the main unit is to be removed, disassemble it in the reverse of the order in "INSTALLING THE MAIN UNIT".

Installing the Main Unit in TOYOTA Vehicle

Install by using parts attached to the vehicle. (Screws marked ★ are attached to the vehicle.)

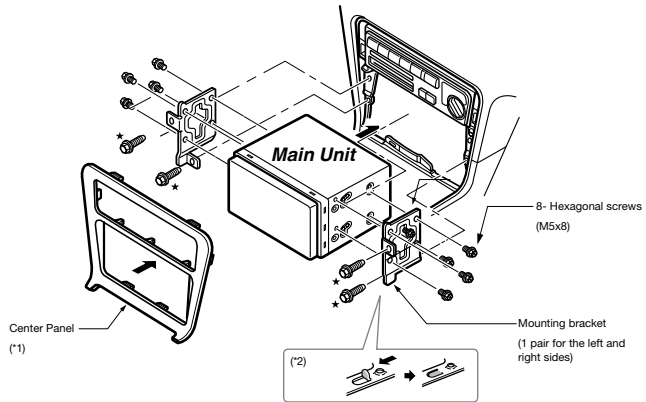

*1. Some panel openings are too small for the unit depending on the vehicle type and model. In such a case, trim the upper and lower sides of the panel frame by about 0.5 to 1.5 mm so the unit can be inserted smoothly.

*2. If a hook on the installation bracket interferes with the unit, bend and flatten it with a nipper or similar tool.

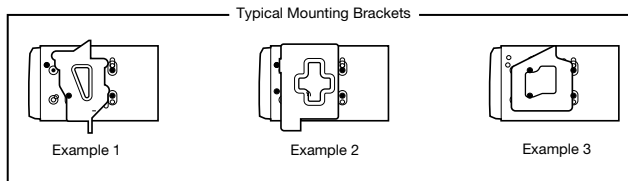

Affix the screws to the ● marks.

WIRE CONNECTIONS

Note:

- Before installing, be sure to disconnect the negative cable of the car battery.
- In the optional devices, the RCA cables and the Connector cables are separately-sold items.
- When connect the HDMI cable, be sure to fix with the HDMI cable holder and Machine screw(M2 x 4).

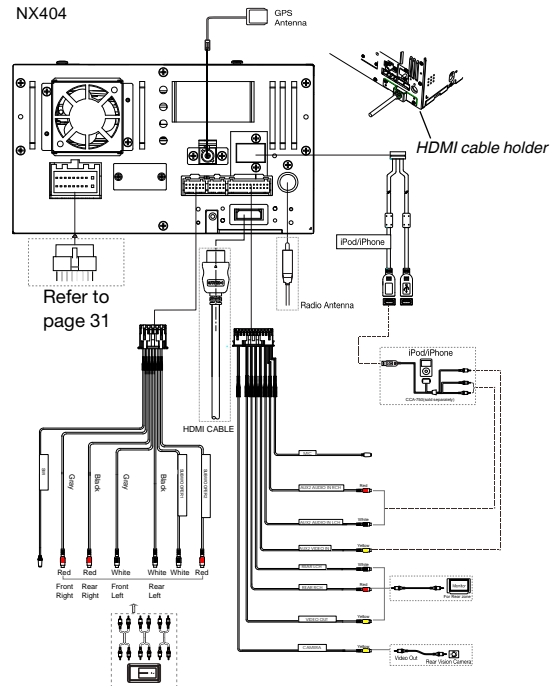

Installing The GPS Antenna

⚠ WARNING

- Do not install the GPS antenna in a place where it may interfere with the operation of the airbag or hinder the driver's visual range.
- Do not use the navigation system with the GPS antenna cord cut off. The power cables in the cord may be short-circuited.

Note:

- The supplied GPS antenna is for installing inside the vehicle. Do not install it outside the vehicle.
- Install the GPS antenna more than 50 cm away from the main unit, other audio devices such as CD player, and a radar detector. If it is installed near these devices, GPS reception may be impaired.
- To improve the GPS signal reception, install the GPS antenna horizontally on a flat plane.
- Do not wax or paint the cover of the GPS antenna. This may reduce the performance of the GPS antenna.
- Install the GPS antenna at least 10 cm away from the windshield.
- Wipe off the dirt of the mounting surface before installing the GPS antenna.

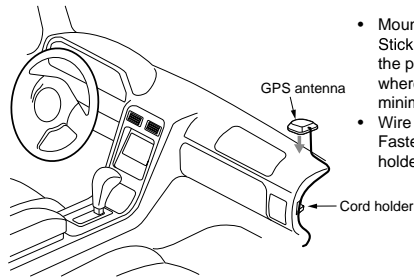

- Mount the GPS antenna. Stick it surely on a flat plane of the passenger side dashboard where GPS signal interruption is minimized.
- Wire the GPS antenna cord. Fasten the cord using the cord holders.

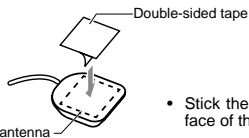

- Stick the double-sided tape to the bottom face of the GPS antenna.

Cautions on Wiring

1. Be sure to turn the power off before wiring.
2. Be particularly careful where you route the wires. Keep them well away from the engine, and exhaust pipe, etc. Heat may damage the wires.
3. If the fuse should blow, check to see if the wiring is correct. If a fuse is blown, replace it with a new one of the same amperage rating as the original (15A FUSE).
4. To replace the fuse, remove the old fuse on the back of the unit and insert the new one. (Figure 7)

NOTE:

There are various types of fuse holder. Do not let the battery side touch other metal parts.

⚠ CAUTION

After the connection, fix the cord by a clamp or insulation tape for protection.

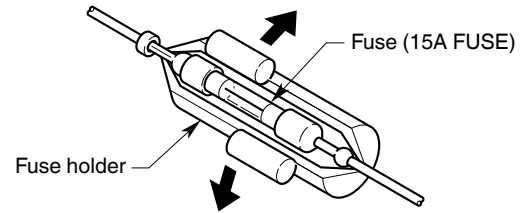

Figure 7

Connecting the parking brake cord

Connect the cord to parking brake lamp ground in the meter panel.

Note:

- Connecting the parking brake cord to lamp ground allows you to watch iPod/iPhone video/DVD video/AV input when the parking brake is engaged.
- When the parking brake cord is not connected, the monitor will not show any video sources.
- If "AUDIO ONLY" appears on the screen just after turning on the ACC power of the car, release the parking brake while confirming safety, and then engage the parking brake again.

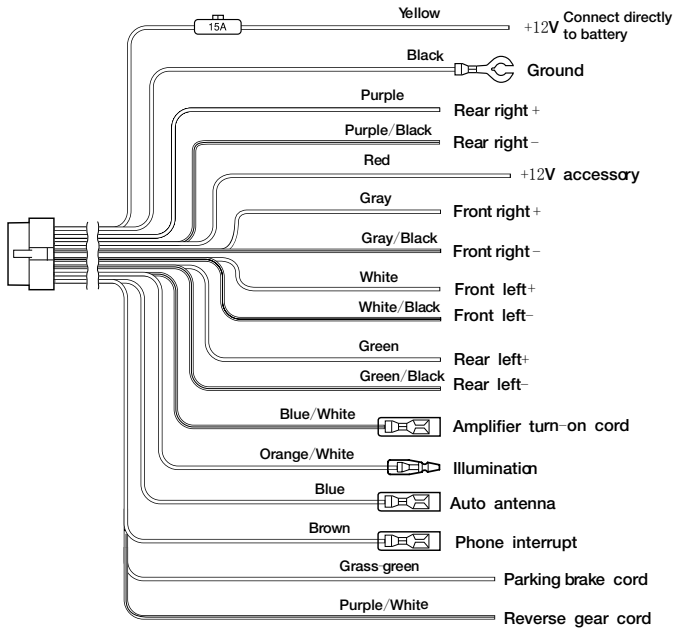
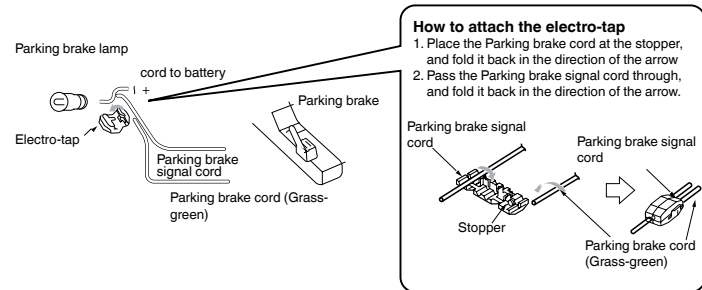

Note:

*1: Connecting the PHONE INTERRUPT terminal
The phone interrupt will mute the audio if the lead receives a negative or ground signal.

Clarion Co., Ltd.

All Rights Reserved. Copyright © 2013: Clarion Co., Ltd.
Printed in China / Imprimé en Chine / Impreso en China

Free Manuals Download Website

<http://myh66.com>

<http://usermanuals.us>

<http://www.somanuals.com>

<http://www.4manuals.cc>

<http://www.manual-lib.com>

<http://www.404manual.com>

<http://www.luxmanual.com>

<http://aubethermostatmanual.com>

Golf course search by state

<http://golfingnear.com>

Email search by domain

<http://emailbydomain.com>

Auto manuals search

<http://auto.somanuals.com>

TV manuals search

<http://tv.somanuals.com>