



CyberHome

We bring DVD Home!

CH-RDV 2000

USA Version 1.0

DVD Player w/ CD-RW Owner's Manual



Welcome to the Digital Video Revolution!

With its dual-drive design, the CH-RDV 2000 performs all the advanced playback functions of the latest DVD players, while also offering disc duplication and selected file copy functions for CD-Audio, MP3, JPG and Data Discs. The On-Screen Burner Interface makes copy operations simple to perform. Duplicate an entire disc or select particular files for copy to CD-R/RW discs. The Burner Interface also lets you erase CD-RW discs quickly and easily. And of course, your Cyber Home DVD Player is designed to provide a great Home Theater experience with super-crisp Video and thundering Digital Sound.

Please retain this User Manual for future reference. Remember to read the manual carefully before connecting and powering on the unit.



www.cyberhome.com

Important Safety Instructions

When using this DVD player, basic instructions should always be followed, including the following:

- 1) Read these instructions
- 2) Keep these instructions
- 3) Heed all warnings
- 4) Follow all instructions
- 5) Do not use this apparatus near water
- 6) Clean only with dry cloth
- 7) Do not block any ventilation opening, Install in accordance with the manufacture's instructions
- 8) Do not install near any heat sources such as radiators, heat registers, stoves, or other apparatus (including amplifiers) that produce heat.
- 9) Do not defect the safety purpose of the polarized plug. A polarized plug has two blades with one wider than other. The wide blade is provided for your safety. If the provided plug does not fit into your outlet, consult an electrician for replacement of the obsolete outlet.
- 10) Protect the power cord from being walked on or pinched particularly at plugs, convenience receptacles, and the point where they exit from the apparatus.
- 11) Only use attachments / accessories specified by the manufacturer.

- 12) Use only with the cart, stand, tripod, bracket, or table specified by the manufacturer, or sold with the apparatus. When a cart is used, use caution when moving the cart / apparatus combination to avoid injury from tip-over.



- 13) Unplug this apparatus during lightning storms or when unused for long periods of time.
- 14) Refer all servicing to qualified service personnel. Servicing is required when the apparatus has been damaged in any way, such as power-supply cord or plug is damaged liquid has been spilled or objects have fallen into apparatus, the apparatus has been exposed to rain or moisture, does not operate normally, or has been dropped.

SAVE THESE INSTRUCTIONS

Important Safety Instructions (Cont'd)

WARNING:

TO REDUCE THE RISK OF FIRE, ELECTRIC SHOCK OR ANNOYING INTERFERENCE, DO NOT EXPOSE THIS APPLIANCE TO RAIN OR MOISTURE AND ONLY USE THE RECOMMENDED ACCESSORIES.

CAUTION:

TO REDUCE THE RISK OF ELECTRIC SHOCK, DO NOT REMOVE THE COVER (OR BACK). NO USER-SERVICEABLE PARTS INSIDE. REFER TO QUALIFIED SERVICE PERSONNEL FOR SERVICING.



CAUTION
RISK OF ELECTRIC SHOCK
DO NOT OPEN



The lightning flash with arrowhead symbol, within an equilateral triangle, is intended to alert the user to the presence of not isolated dangerous voltage within the inside of the product that may be sufficient magnitude to constitute a risk of electric shock to persons.



The exclamation point within an equilateral triangle is intended to alert the user to the presence of important operating and servicing instructions in the literature accompanying the appliance.

**CLASS 1 LASER
PRODUCT**

The DVD-Player is a class 1 laser product. However, this DVD-Player uses a visible laser beam, which could cause hazardous radiation exposure, if directed. Be sure to operate the DVD-Player correctly as instructed. When this DVD-Player is plugged into the plug socket, do not place your eyes close to the opening of the disc tray and other openings to look into the inside of this player. Do not open covers and do not repair yourself. Refer to the qualified personnel for servicing. Invisible laser radiation when cover is opened and interlock failed or defeated. Avoid direct exposure to beam.

POWER CORD PROTECTION:

To avoid any malfunctions of the unit and to protect against electric Shock, fire or personal injury, please observe the following:

- Hold the plug firmly when connecting or disconnecting the AC power cord to this unit.
- Do not connect or disconnect the AC power cord with wet hands.
- Keep the AC power cord away from heating appliances.
- Never put any heavy object on the AC power cord.
- Do not attempt to repair or reconstruct the AC power cord in any way.
- Remove dust, dirt, etc. on the plug at regular intervals.
- If the unit has been dropped or otherwise damaged, turn off the power and disconnect the AC power cord.
- If smoke, odors or noises are emitted from the unit, turn off the power and disconnect the AC power cord.

PLACEMENT:

Avoid placing the unit in areas of:

- direct sunlight, heating radiators or closed automobiles
- high temperature [over 35° C (95° F)] or high humidity (over 90%)
- excessive dust
- vibration, impact or where the surface is tilted, as the internal parts may be seriously damaged

NON-USE PERIODS:

- When the unit is not used, turn the power off.
- When the unit is unused for a long period of time, the unit should be unplugged from the household AC outlet.

NO FINGERS OR OTHER OBJECTS INSIDE:

- Touching internal parts of this unit is dangerous and may cause serious damage to the unit. Do not attempt to disassemble the unit.
- Do not put any foreign object on the disc tray.

KEEP AWAY FROM WATER AND MAGNETS:

- Keep the unit away from flower vases, tubs, sinks, etc. If liquids are spilled into the unit, serious damage could occur.
- The apparatus shall not be exposed to dripping or splashing and no objects filled with liquids, such as vases, shall be placed on the apparatus.
- To reduce the risk of fire or electric shock, do not expose this apparatus to rain or moisture
- Keep magnetic objects, such as speakers, distant from the player.

STACKING:

- Place the unit in a horizontal position and do not place anything heavy on it.
- Do not place the unit on amplifiers or other equipment, which may become hot

CONDENSATION:

Moisture may form on the lens in the following cases:

- immediately after a heater has been turned on
- in a steamy or very humid room
- the unit is moved from a cold environment to a warm one

If moisture forms inside this unit, it may not operate properly. In this case, turn off the power and wait about one hour for the moisture to evaporate.

NOISE INTERFERENCE WHILE A BROADCAST IS BEING RECEIVED:

Depending on the reception condition of the TV, interference may appear on the TV screen while you are watching a TV broadcast, if the unit is switched on. This is not a malfunction of the unit or the TV. To watch a TV broadcast, turn off this unit.

SAVE THESE INSTRUCTIONS

Table of Contents

General Information

Safety Instructions	2-3
Table of Contents	4
DVD Player Features & Supported Discs	5
Caring for Optical Discs	6

Player Layout, Controls and Functions

Preparing and Using the Remote Control	7
Remote Control Functions	8
DVD Front Panel Functions	10
DVD Display Functions	11
Dimming the Front VFD Display	11
Back Panel Connectors	12

Audio and Video Connections

Connecting the DVD Player to your TV/Receiver	13
Composite / S-Video & Stereo Audio Connections	14
Component Video Connections	15
Dolby/DTS 5.1 Channel & Digital Audio Connections	16

Basic Playback Functions

Getting Started - Powering On & Playing a Disc	17
Stopping and Pausing Play	18
Navigating Disc Menus	19

Advanced Playback Functions

Fast Forward/Reverse & Slow Motion Scanning	20
Skip Forward and Skip Back	20
Jumping to a Specific Chapter/Track or Time Position	21
Previewing Titles, Chapters or Tracks Before Playback	22
Saving Locations for Quick Play with Bookmarks	22
Repeating a Title, Chapter/Track or Disc	23
Repeating a Specific Time Segment	23
Playing Tracks in a Particular Order with Program Play	24
Playing MP3 Files with the MP3 Navigator	25
Viewing JPG Files on Your TV	26
Using the Zoom Function	27
More Audio & Video Functions	28
Putting it All Together with the Display Button	29

Disc Copy Functions

Introduction to File Copy and Disc Duplication	30
The On-Screen Burner Interface	31
Duplicating a Disc with Disc Copy	32
Selecting and Copying Files	33
Erasing a CD-RW Disc	35
About Multi-Session Discs	36

Setting Player Options

Using the On-Screen Setup Menu	37
Parental Lock and Other Options	38

Adjusting Audio and Video Settings

Video Setup Options	39
Audio Setup Options	40
Language Options	41

Further Information

Troubleshooting Common Problems	42
Specifications	43
Glossary of DVD-related Terms	44-45
Index	46

DVD Player Features & Supported Discs

Welcome to the Digital Video Revolution! Your new DVD Player opens the door to a much richer home entertainment experience than you've ever seen before. Enhanced Video and Sound quality, as well as greater flexibility and options are just some of the benefits of Digital Video over conventional formats such as VHS. And your DVD Player also doubles as a multi-function CD-RW Copier, able to duplicate discs and copy selected files from Audio CDs and Data Discs. It also supports playback of SVCD, VCD, CD Audio Discs, as well as MP3 Music Files and JPG Images.

Features

- Triple 10-bit Video DACs.
- Suitable for multiple disc formats, including DVD, Video CD (versions 1.1 and 2.0), conventional Audio CD's, CD-R/RW, MP3, JPG and DTS.
- Multiple levels of slow playback. Slow motion without distracting signals in various speeds.
- Repeat playback - Video segments can be selected for repeat playback.
- 2X,4X Zoom In on picture in still or playback mode.
- Program Function - Specify the playback sequence for Audio CD or VCD Tracks.
- Coaxial and Optical Digital Audio Outputs
- 5.1 Channel and Stereo Analog Audio Outputs.
- Component, S-Video & Composite Video Outputs.
- Direct track selection function (MP3 and CD) - Number buttons can be used for quick selection of MP3 and CD titles with the remote control.
- Duplicate discs of 700MB or less capacity. Disc formats supported include CD-ROM, CD-DA, Data CD, MP3, JPG and Audio CD. *Copying of DVD, SVCD and VCD discs is not supported.
- Copy selected files or tracks from CD-ROM, MP3, JPG and Audio CDs to CD-R/RW discs.
- Erase CD-RW discs to free up space. Quick Erase takes only 1 minute. Use Full Erase to completely wipe-out sensitive data.

Supported Disc Formats

The following is a list of disc types that are suitable for play in your DVD Player:



Digital Video Discs

This player is suitable for DVDs of 12cm and 8cm sizes. Single-Sided and Double-Sided DVDs of Single-Layer or Double-Layer type are supported. Discs of NTSC and PAL color systems are supported.

Note: This DVD Player adheres to Region Code Standards. Units sold in North America will only play Region Code 1 discs. The region code is marked on the disc as shown:



Video CDs

This player supports Video CDs with or without the PBC function. PBC allows for more advanced navigation and features.



Compact Discs - Digital Audio

Music CDs may be used in this player. Also, CD-R and CD-RW discs containing CD-Audio tracks are supported.



MP3 Discs (Including CD-R & CD-RW)

This player features an On-Screen MP3 Player for navigating and playing MP3 files stored on disc. Files must have the ".MP3" extension. When recording MP3 files to a CD-R or CD-RW disc, you must "close the session" before the disc will be useable with this player. A maximum of 250 directories and tracks are allowed.



CD-R/RW Discs for Recording and Copying

CD-Recordable (CD-R) and CD-ReWritable (CD-RW) discs are supported for Disc Copy and File Copy Operations.

*Specifications are subject to change without notice. *All trademarks, logos, brand names and company names are the property of their respective owners.

Caring for Optical Discs

Handling of Discs:

Please hold the disc by gripping the rim or by placing the index finger in the central hole. Never touch the signal surface, which is shiny. This applies to both sides of double sided discs.

Cleaning of Discs:

Finger prints or stains on the surface of the disc may cause signal loss. Depending on the degree of the stain, the reflected luminosity from the signal surface may be weakened, resulting in degraded picture quality. Therefore, please use a soft cloth and wipe in a radiating manner from the center of the disc to the outer rims when cleaning the disc surface.

If the surface of your disc is very dirty, please wipe the disc with a moist cloth, followed by a dry soft cloth to remove all water stains.

Never use electrostatic prevention products or solutions which contain benzene, thinner or any other vaporizing substances, as they may damage the disc surface.

Never add labels or adhesive tapes on the discs and be careful not to scratch or damage the disc surface.

Storage of Discs:

To prevent discs from becoming bent or deformed, they should be vertically kept in the disc storage case. To prevent damage, avoid leaving discs in your car, where they may be subject to direct sunlight and high temperature.

Please thoroughly read the "Instruction Points for Attention" on the discs.

Cleaning the DVD Player:

The control panel and the case of the player will only require occasional wiping with a soft cloth. Areas with stubborn stains can be cleaned with a soft cloth dipped in a neutral detergent. To prevent damaging the player, never use vaporizing solutions.

Disc Accessories:

Do not use any disc accessory to improve the audio quality, disc protective solutions or lens cleaner. These products may cause problems.

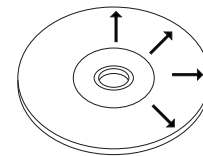
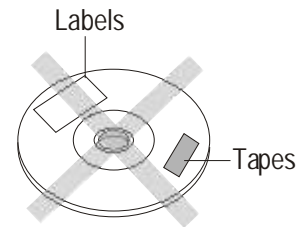
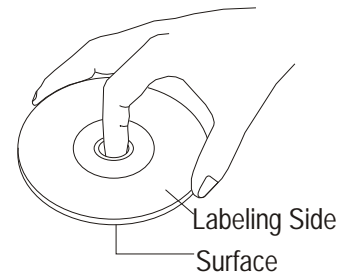

Preparing and Using the Remote Control

Installing the Batteries

If the remote control only operates when you get closer to the DVD Player, it may mean the batteries are weak. Please replace the two batteries simultaneously with two new batteries (Size AAA, R03, 1.5V) of the same type. Please note the positive (+) and negative (-) polarity shown inside the battery compartment on the remote.

1. Push down and then outwards to remove the battery compartment cover.
2. Insert Batteries following polarity marked inside compartment.
3. Slide Cover back into place.

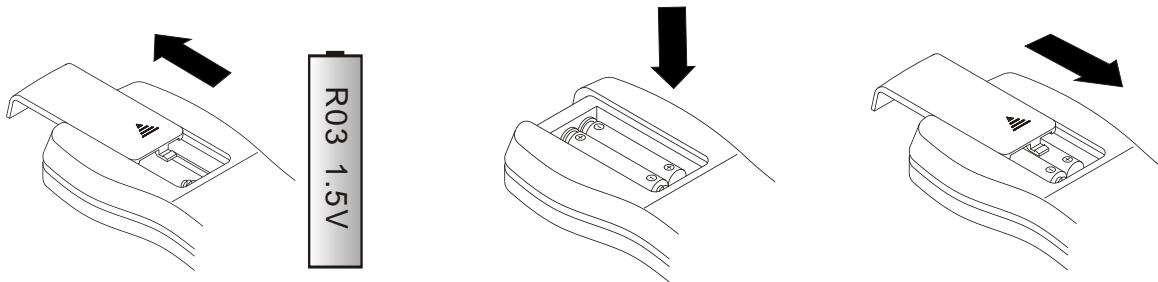

Important Note about Batteries

- When changing batteries, it is not recommended to use a mix old and new batteries or batteries of different brands simultaneously.
- If the unit will not be used for an extended length of time, it's wise to remove the batteries before storage.
- The life of the batteries depends on the amount of usage. With typical use, a battery life of approximately 6 months can be expected.

Operation of Remote Control

When using the control, please aim at the device's remote control sensor, located in the DVD Player's Display area. A 30 degree angle is recommended for best operation.

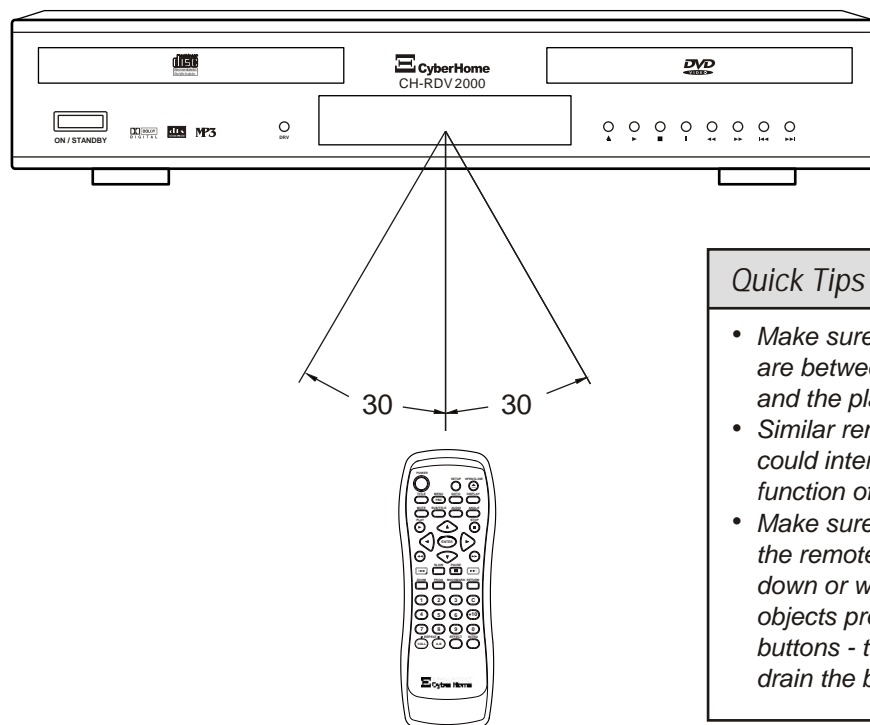

Remote Control Functions (1 of 2)

Understanding the Buttons on the Remote

The Remote Control provides access to the DVD Player's advanced functions, such as searching, repeating video segments, accessing the Setup Menu, choosing subtitle mode, muting the volume and pausing the action, just to name a few. The remote is also used to put the unit into "standby" mode, and power it on again.

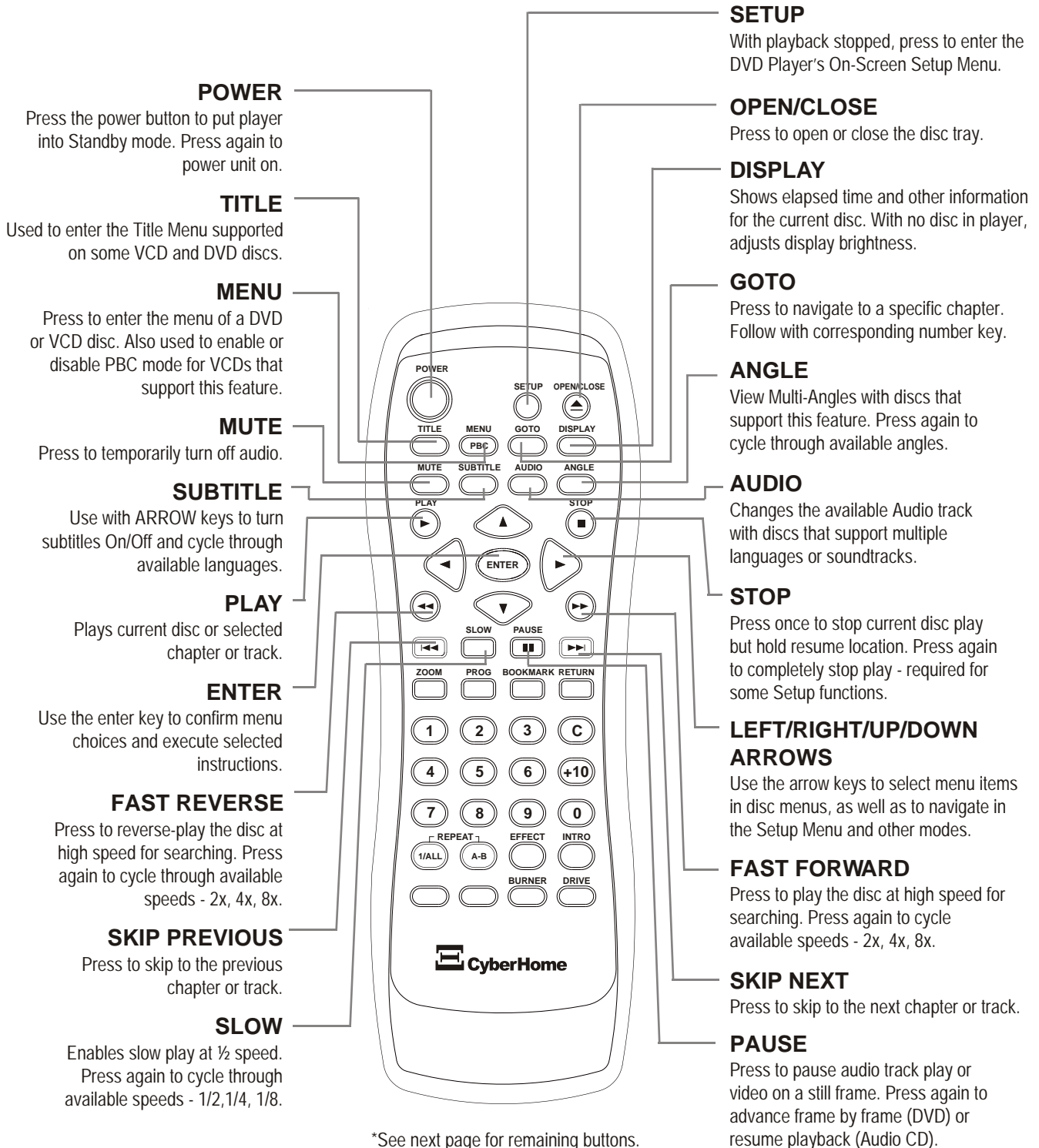

Remote Control Functions (2 of 2)

*See previous page for upper buttons.

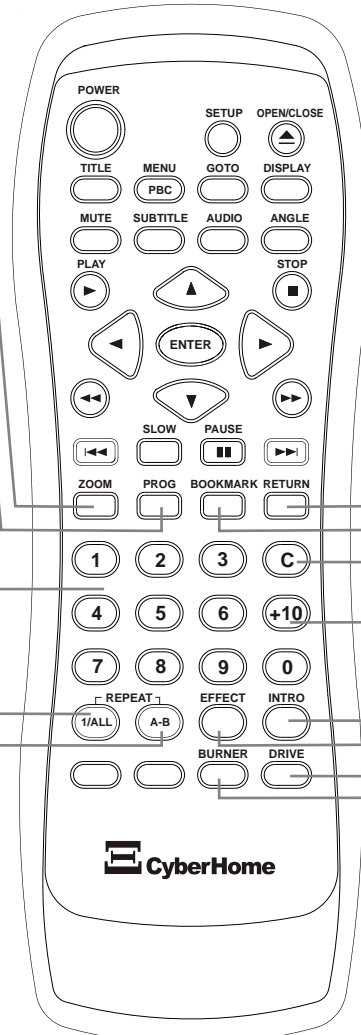

ZOOM
Press to zoom in on picture during playback or on a still frame.

PROG
Create a custom play list of selected tracks and play sequence.

NUMBER BUTTONS
Use the number buttons to input numerical values during programming, with GOTO, or to directly select a track to play.

REPEAT 1/ALL
Press to enable repeat mode. Press again to cycle through choices - Repeat Chapter, Title or Disc.

REPEAT A-B
Press this button to set the start of the segment you wish to repeat. Press again to set the end point of the segment and begin repeat play.

POWER
Turns the device on or off.

SETUP
Accesses the setup menu.

OPEN/CLOSE
Used for disc navigation.

TITLE
Selects a specific title on a disc.

MENU
Accesses the main menu.

PBC
Previous Button Command.

GOTO
Goes to a specific track or chapter.

DISPLAY
Toggles the display on or off.

MUTE
Mutes the audio.

SUBTITLE
Selects a subtitle.

AUDIO
Selects an audio track.

ANGLE
Selects a video angle.

PLAY
Starts playback.

ENTER
Confirms a selection.

STOP
Stops playback.

SLOW
Slows down playback.

PAUSE
Pauses playback.

ZOOM
Zooms in or out on the picture.

PROG
Programs a custom play list.

BOOKMARK
Sets a bookmark on the disc.

RETURN
Returns to the previous menu.

1-0
Number keys for direct track selection.

+10
Used for entering values greater than 10.

REPEAT 1/ALL
Enables repeat mode.

REPEAT A-B
Sets repeat segment.

EFFECT
Adjusts audio effects.

INTRO
Shows chapter introduction.

BURNER
Accesses the burner interface.

DRIVE
Switches between DVD and CD-RW drives.

RETURN
Returns to the previous menu.

BOOKMARK
Stores the current point on the disc.

C - CANCEL
Clears input or cancels programmed titles.

+10
Used for entering values greater than 10.

INTRO
Shows chapter introduction.

EFFECT
Adjusts audio effects.

DRIVE
Switches between DVD and CD-RW drives.

BURNER
Accesses the burner interface.

CyberHome

DVD / CD-RW Front Panel Functions

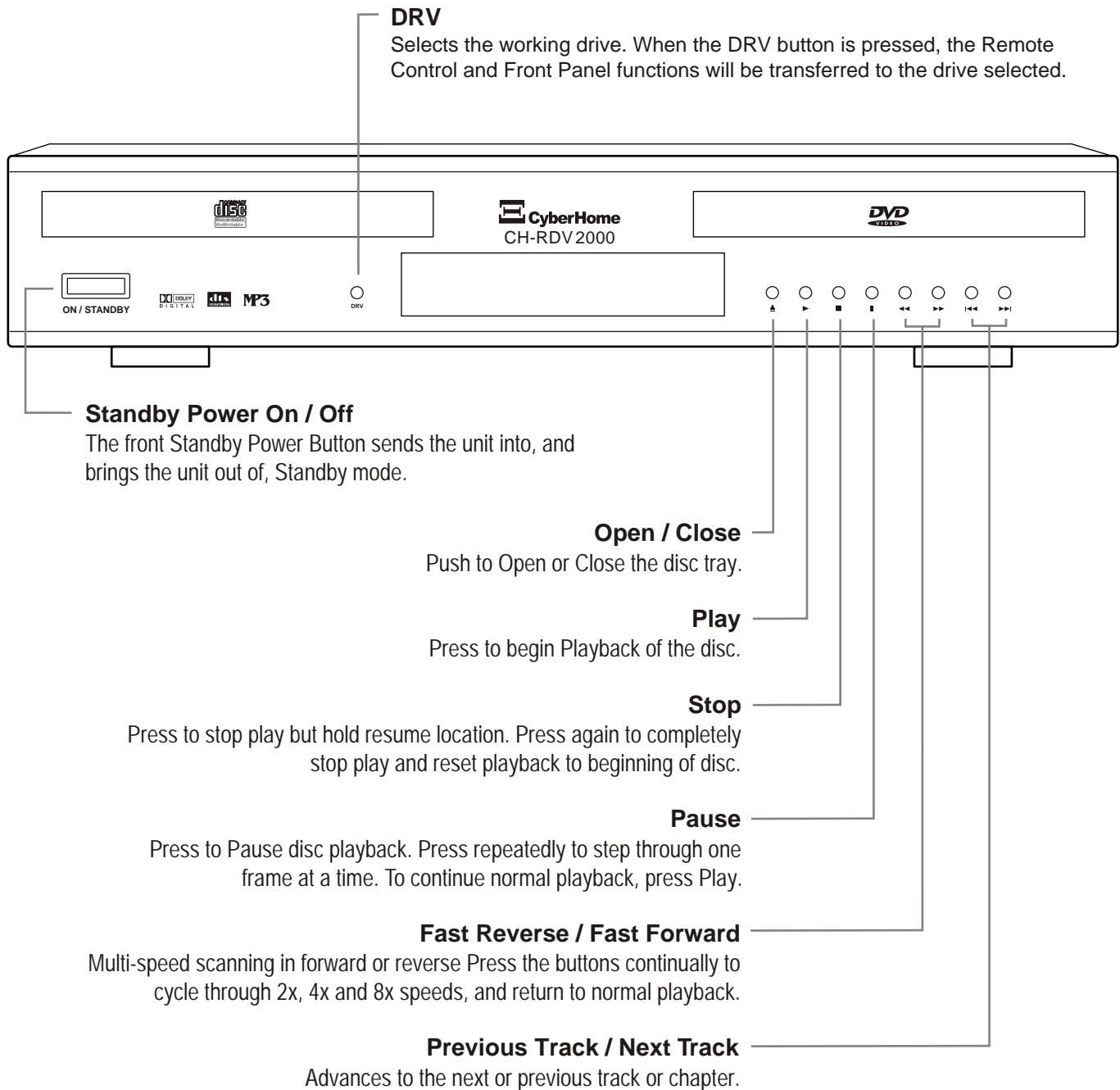

DVD Display Functions

Display Functions

The DVD Player Display shows current operation, disc type, elapsed playback time and other useful information. Some functions require specific disc formats or features.

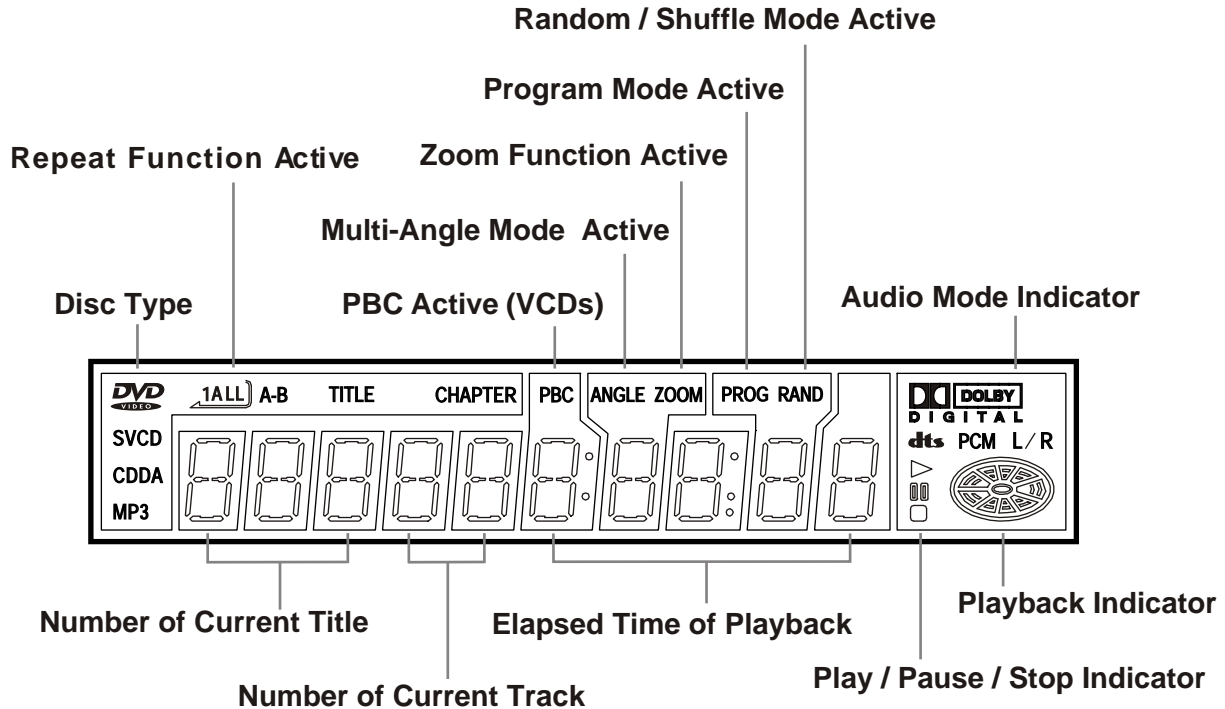

Dimming the Front VFD Display

Adjusting the Brightness of the Front Display

With NO DISC in the unit, the DISPLAY button functions as a 4-phase Dimmer for the DVD Player's front VFD (Vacuum Fluorescent Display).



Eject the Current Disc

Open the disc tray to change the operation of the DISPLAY key to the DIMMER function. After removing the disc, you may close the disc tray to better see the front display.

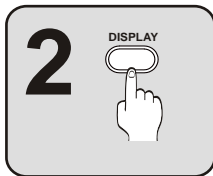

Press the DISPLAY Button

Press the DISPLAY button repeatedly to cycle through the four brightness levels.

INSERT DISC INSERT DISC
 INSERT DISC INSERT DISC

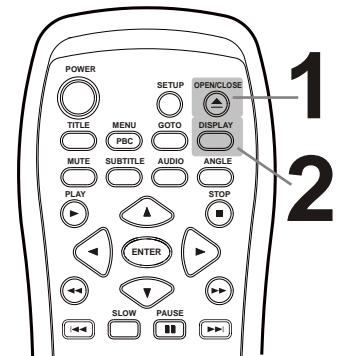

Back Panel Connectors

Connections on the Back Panel

The back panel is where you'll find all the physical connections for the DVD Player. You will only use one Video and one Audio connection at any given time. For instance, if you're using the Composite Video jack to connect to your TV, the S-Video and Component connectors will be unused.

Component Video Connectors

Y, Pr & Pb connectors for use with TVs compatible with Component Video.

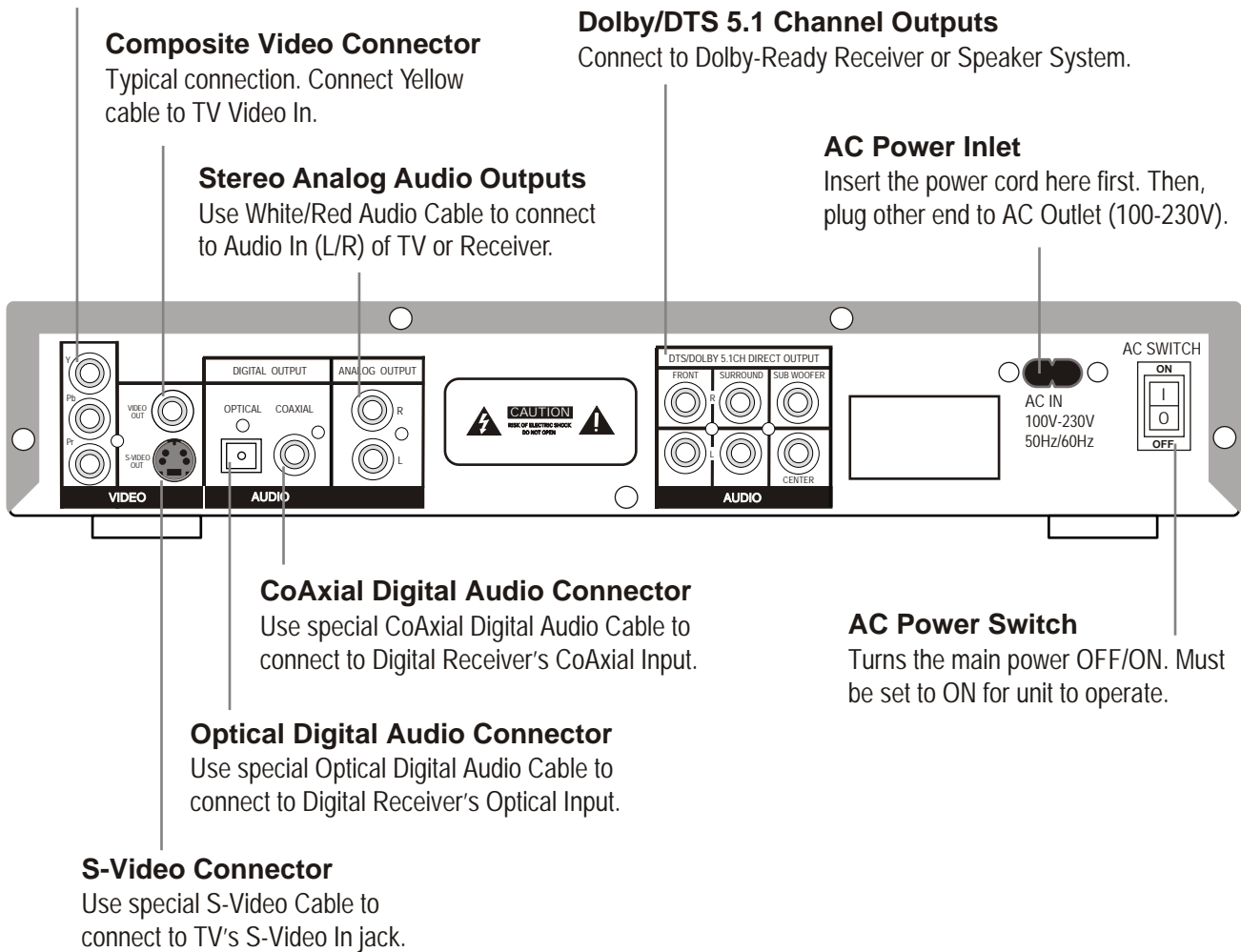

Connecting the DVD Player to your TV / Receiver

Determining the Video & Audio Connections You Will Use

The first step to using your new DVD Player is to make the cable connections that will allow you to see the video and hear the audio on your TV and optional Stereo Receiver. Your DVD Player has multiple Video and Audio outputs. Generally, you will only use one Video and one Audio output and any one time. The type of outputs you use will be determined by the capabilities of your Television or receiver. It is recommended that you use the highest quality output that your TV or receiver will support.

Television Connections (One Required)

In order to use your DVD Player, your TV must support at least one of the Video Input types shown below. To get started, identify the best Video Connection shown below that your TV offers and proceed to that section. If you are using your TV's speakers for audio, rather than a separate receiver or amplifier, you will use the Stereo Audio In, outlined in sections 1 and 2.

Composite Video & Stereo Audio

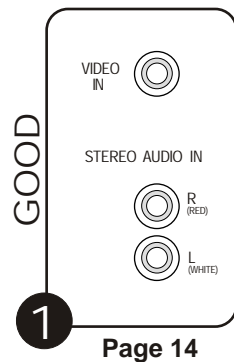

S-Video & Stereo Audio

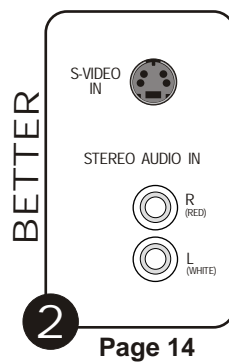

Component Video

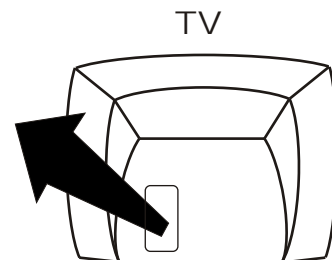
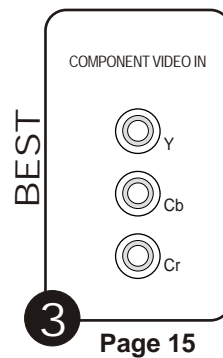

Receiver/Speaker Connections (Optional)

To enjoy the Dolby and/or DTS Digital Surround Sound most DVD movies are presented in, you'll need a 5.1 Channel Sound System. Whether you choose an inexpensive, self-powered 5.1 Channel Speaker System, or a more advanced setup with a Digital Receiver powering a set of High-Performance Speakers, your player provides the outputs required. The 5.1 Channel Analog outputs can connect directly to a 5.1 Channel Speaker System (the most economical method) or a Dolby-Ready Receiver. For the ultimate in Digital Audio, use the player's Optical or CoAxial Digital Audio outputs with a Digital Receiver powering high-performance Speakers.

DTS/Dolby 5.1 Channel Analog Audio

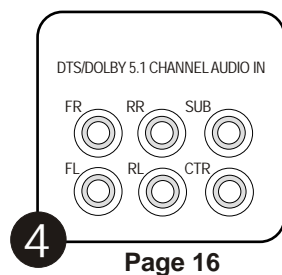

Optical & CoAxial Digital Audio

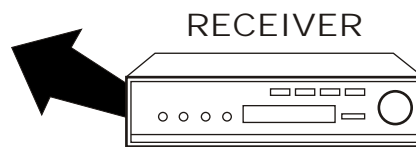
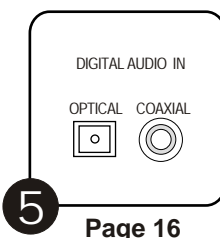

Composite / S-Video & Stereo Audio Connections

1 Typical Connection - Connecting to a TV with Composite Video In and Stereo Audio In

If your TV has only a single Video Input jack, typically a yellow-colored plug, you will use the Composite Video output of the DVD Player for the Video Connection. We'll also assume your TV has Red and White Stereo Audio In connectors. You will use these for the Audio Connection.

- Use the included Video Cable (Yellow) to connect the Video Out of the DVD Player to the Video In of your TV.
- Connect the Stereo Audio outputs (Red-Red, White-White) of the DVD Player to the matching Inputs of your TV.
- Connect the Power Cord to the DVD Player and AC Power Outlet.
- Turn on the TV and DVD Player (power switch on back) and select the Video Input on your TV. On some models, this may be called "Input 1" or "Aux In". You should now see the DVD Player's splash screen on your TV.
- Change the ANALOG Setting in the DVD Player's Setup Menu to 2CH. (See pg 40)

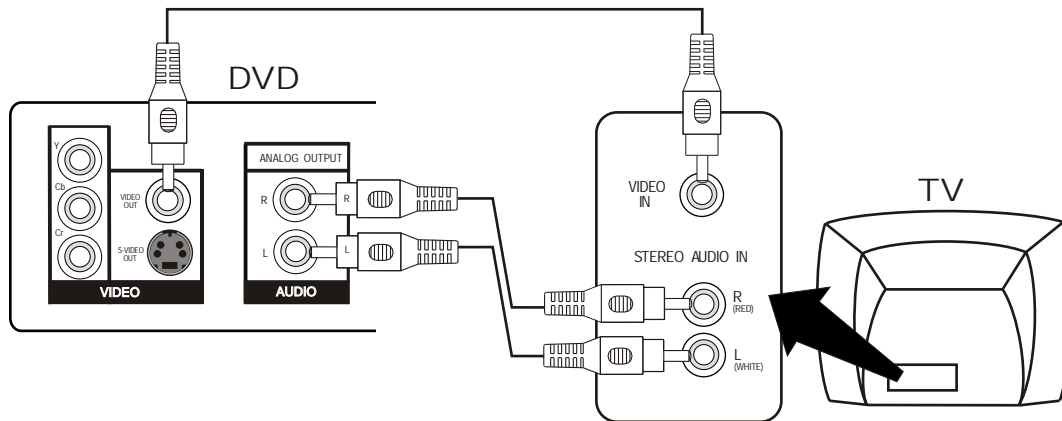

2 Connecting to a TV with S-Video In and Stereo Audio In

If your TV has an S-Video Input, it's recommended that you use this connection. S-Video separates brightness and color signals, resulting in higher video quality than Standard Composite Video.

- You must purchase a separate S-Video Cable for this connection (not included).
- Connect the S-Video Out from the DVD Player to the S-Video In of your TV.
- If you are not using a separate receiver for audio, connect the Stereo Audio outputs (Red - Red, White - White) of the DVD Player to the corresponding Inputs of your TV
- Connect the Power Cord to the DVD Player and AC Power Outlet.
- Turn on the TV and DVD Player (power switch on back) and select the S-Video Input on your TV. On some models, this may be called "Input 2" or "Video 2". You should now see the DVD Player's splash screen on your TV.
- Change the OUTPUT Setting in the DVD Player's Setup Menu to S-VIDEO. (See pg 39)
- Change the ANALOG Setting in the DVD Player's Setup Menu to 2CH. (See pg 40)



S-Video Connector

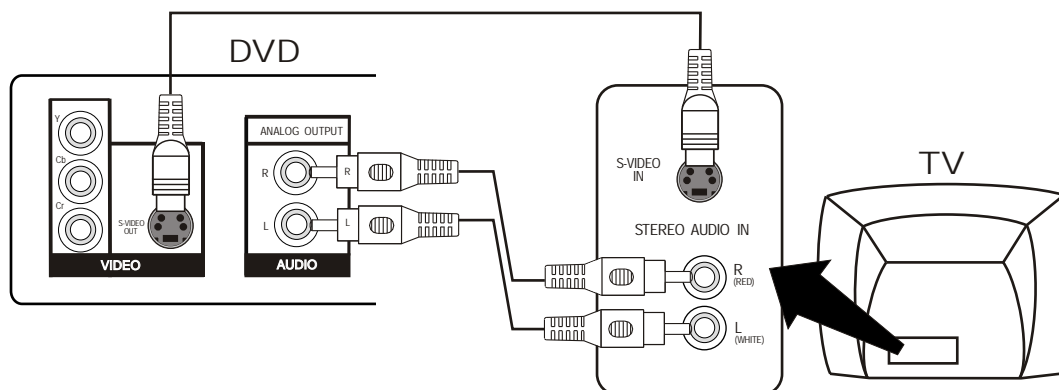

Component Video Connections

3 Connecting to a TV with Component Video Inputs

Component Video separates the Video Signal into three separate “components”, resulting in a higher quality picture than S-Video or Standard Composite Video. In order to use Component Video, you must use a TV equipped with Component Video Inputs. You’ll also need (3) Component Video Cables (not included) and a Composite (included) or S-Video Cable used for setup only.

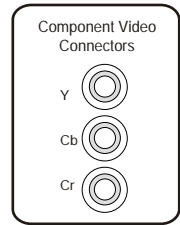

Step 1: Connect the DVD Player using the Composite or S-Video Connection

In order to Switch your DVD Player’s Video Output to Component Video, you must first connect using the Composite or S-Video Connectors. This will allow you to use the player’s Setup Menu to change the Video Output Setting. For details, see page 13. Once you see the player’s splash screen on your TV, proceed to Step 2.

Step 2: Enter the Setup Menu to Change the Video Setting

With disc play stopped, press the SETUP button on the Remote Control to enter the DVD Player’s On-Screen Setup Menu. Use the ARROW keys to navigate down to the VIDEO menu and press ENTER. Use the ARROW keys to proceed down to the OUTPUT setting. Press ENTER. Use the UP/DOWN keys to select YCbCr. Press ENTER to confirm your choice. You will now see the video disappear as the player switches to YCbCr Component Output.

For Help on Using the Setup Menu, see pg 37.

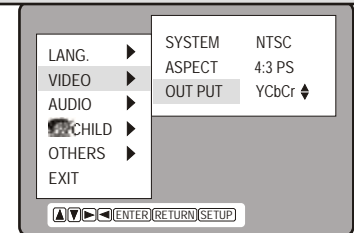

Step 3: Connect the DVD Player using the Component Video Cables

At this point, turn off the TV and DVD Player and unhook the Composite or S-Video cable used so far. Connect the separate Component Video Cables to the appropriate jacks. Normally, cables and jacks are color-coded to make connection easier. Power on the DVD Player and TV and set your TV to the Video In Channel associated with the Component Video inputs (“Video 3”, “Input 3”, etc.) You should now see the DVD Player splash screen on your TV.

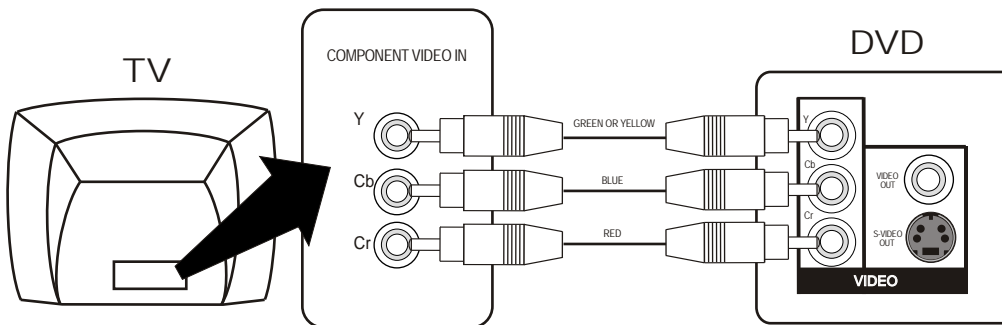

Quick Tips

- If you need to reset the Player’s Video Settings to factory defaults, Reset the player, Open the Disc Tray and press “STOP - 2 - 0 - 0 - 2” on the Remote Control.

Dolby/DTS 5.1 Channel & Digital Audio Connections

4 Using the Dolby/DTS 5.1 Channel Analog Outputs

Your DVD Player also features a set of 5.1 Channel Outputs for Dolby Ready Receivers, Amplifiers and Speaker Systems. When you use the 5.1 Channel Outputs, you're taking advantage of the DVD Player's built-in Dolby Decoder, which decodes the Dolby Digital 5.1 soundtrack on DVD discs to 6 separate analog signals - left front, center front, right front, left rear, right rear, and a sub-woofer (".1") channel.

- You must purchase a separate set of 5.1 Channel connectors (normally included with Speaker Systems).
- Connect each of the (6) outputs to the corresponding Input of your Receiver, Amplifier or Speaker System.
- For Receivers, adjust the Input Source Setting to correspond with the 5.1 Channel Analog Input.
- Make sure the ANALOG Setting in the DVD Player's Setup Menu is set to 5.1CH. (See pg 40)

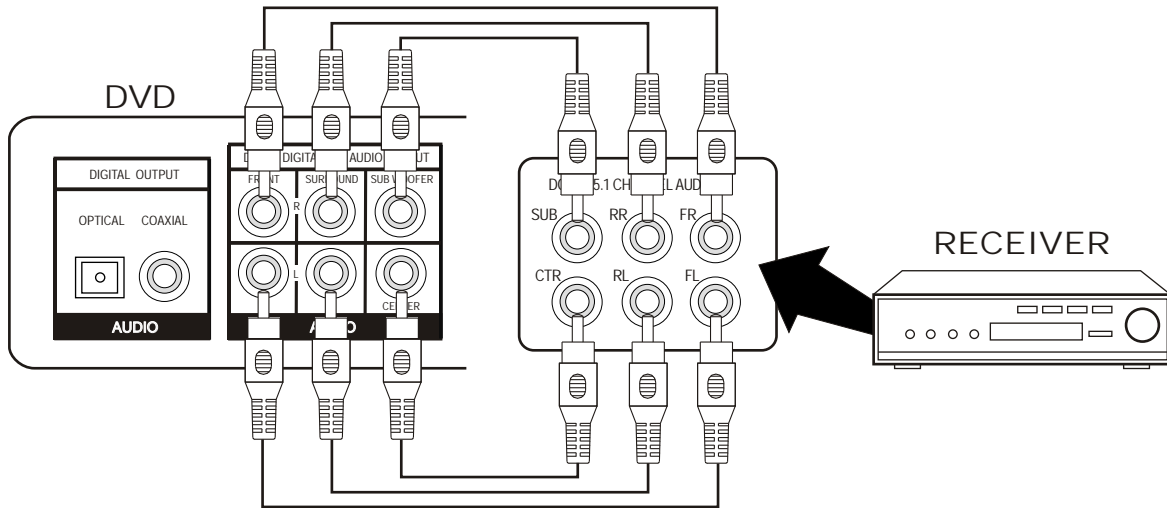

5 Using the Optical and CoAxial Digital Audio Output Connections

Your DVD Player features two Digital Audio Outputs to provide the ultimate in realism for your Home Theater experience. Use this option to get the most out of discs recorded with Dolby 5.1 Digital Surround Sound or Digital Theater System (DTS) by sending the encoded, or "RAW" digital audio signal to your Receiver for decoding. You will only use one Digital Audio Output, depending on which is supported by your receiver or amplifier. You must be using a Digital Receiver with 5.1 Channel Decoding and an Optical or CoAxial Digital Input to take advantage of this feature.

- You must purchase a separate Coaxial or Optical Digital Audio Cable for these connections, as these cables are not included with the DVD Player.
- Connect the Optical or Coaxial Digital Audio Out of the DVD Player to the corresponding Input of your Receiver.
- Adjust your Receiver's Input Source Setting to the correspond with the Digital Audio In.

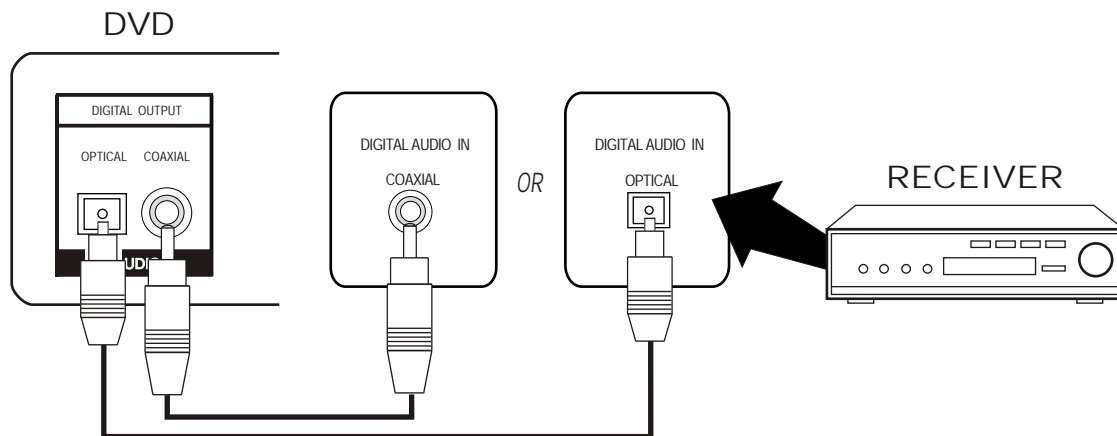

Getting Started - Powering On & Playing a Disc

After Video and Audio Cables are Connected and Power is Applied

Once the DVD Player is properly connected to your TV and possibly your receiver also, turn on your TV and make sure it's set to the correct input channel. The video input is usually configured as channel 0 or 1 on most TVs, but may be referred to as "Input 1" or "Aux In" or similar names. These procedures assume you are using a NTSC-compatible TV - standard for North and South America. If you are using a PAL-type, you will need to change the TV Type first. In this case, see pg 39 - Video Setup Options.

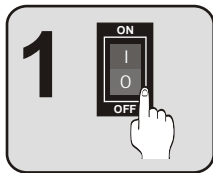

Power on the DVD Player

Push the Power Button on the back of the unit firmly to turn on the player. You should see the message "ON" in the DVD Display. Then, the player will attempt to read a disc. With no disc in the unit, the message INSERT DISC will be displayed.

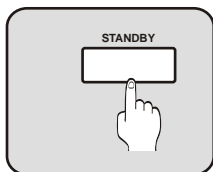

Powering on with the Front Switch

Once the main power switch on the back of the unit is on, the Front power switch can be used to bring the player in and out of STANDBY MODE.

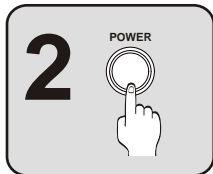

Powering on from the Remote

Once the back power switch is in the ON position, the unit can be turned off and on by the remote. When the unit is turned off by the remote, it will go into STANDBY MODE. This allows the unit to be quickly "awakened" by pressing the POWER key on the remote again.

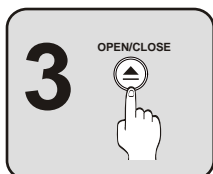

Opening the Disc Tray

Press the OPEN/CLOSE button on the remote or on the player (to the right of the disc tray) to insert a disc. There are two grooves in the disc tray - 12cm and 8cm. Make sure the disc is properly set into the tray. Small 8cm discs must be positioned exactly in the middle groove. Press the OPEN/CLOSE button again to close the disc tray. You will see the message READ on the display. Once the disc is read, you should see the menu screen for DVD discs, or hear sound for an Audio CD.



The Play Button

Most DVDs will automatically display a menu when inserted. However, some discs will require you to press the PLAY button. Also, the PLAY button can usually be used to quickly start a DVD movie when pressed with the menu displayed. This function varies with discs.

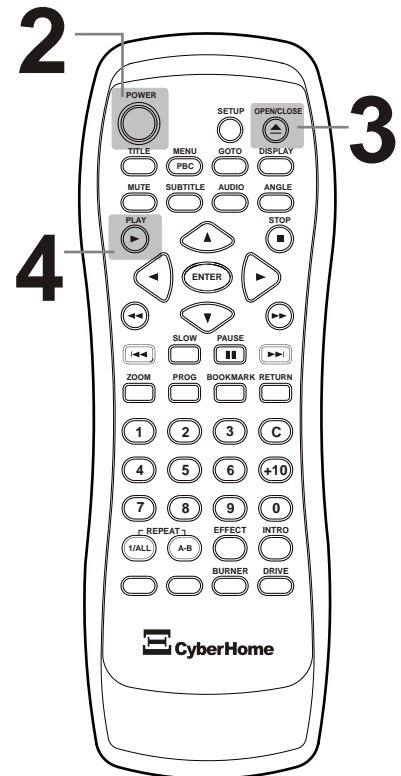

Quick Tips

About Standby Mode

- Your DVD Player is equipped with a power-saving feature called **STANDBY MODE**. When you press **POWER** on the Remote to turn off the unit, it will enter standby mode, where it can be quickly awakened by pressing **POWER** again.

Stopping and Pausing Play

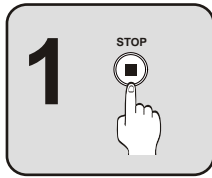

To Stop Disc Play

Press the STOP button to stop playback of the disc. With Audio CDs, VCDs and DVDs, after the STOP button is pressed, the message HOLD will be displayed. The stop point is now saved and you can resume playback by pressing PLAY. Press the STOP key again to reset the play position to the beginning of the disc.

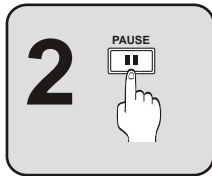

Pausing Disc Play

With DVDs and VCDs, you can pause playback on a still frame with the PAUSE button. Pressing the PAUSE button repeatedly allows you to step through the video in frame-by-frame mode. Pressing PAUSE while playing Audio CDs will mute the sound and hold the play position. Press the PLAY button to resume normal playback.

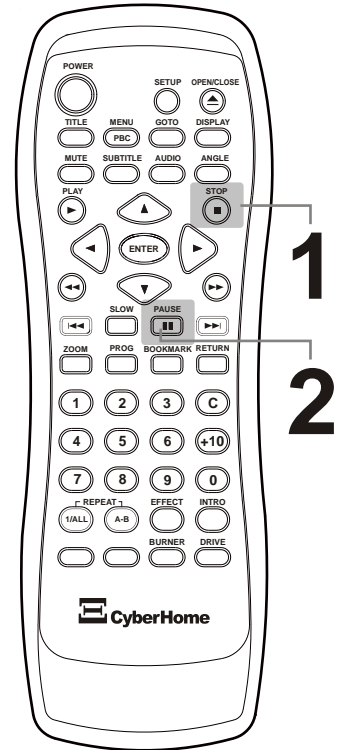

Quick Tips

Screen Saver

- When a DVD or Video CD remains paused on a still frame for an extended length of time - approximately 3 minutes - the Screen Saver will be activated.
- The Screen Saver guards against damage to your TV screen, or "screen burn" which could result in residual images on the TV's CRT tube.



Navigating Disc Menus

Using the MENU and TITLE Buttons to Access Menus on DVD and VCD Discs

Most DVDs and some VCD discs feature menus that will allow you to navigate the various Chapters, Special Features and Setup Options available on the disc. Some menus will automatically be displayed when you insert a disc. To access menus at any time, use the MENU and TITLE buttons. If you see the symbol below when attempting to select a Title or Menu, it means that this type of menu is not available on the disc.

Title menus, for example are not available on some DVDs.

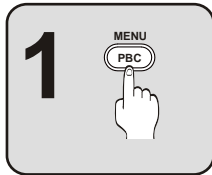

OR

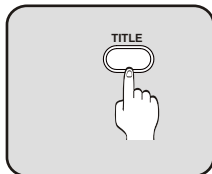

Entering the DVD or VCD Menu

Press the MENU / PBC button to access the DVD menu. If the disc does not have a menu, the symbol described above will be displayed. Used with Video CDs, pressing this button will Enable / Disable the PBC (Play Back Control) menu system. With PBC enabled, the disc menu will be shown. The disc will simply play all tracks in sequence with PBC disabled.

Entering the Title Menu

Title menus are available on some DVDs. These menus allow you to select a particular Title or Chapter to play. With some DVD discs, pressing this button will bring up the normal DVD menu. If the "not available" symbol is displayed on screen, this feature is not available on your disc.

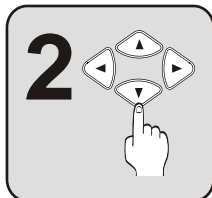

Navigate with the ARROW Buttons

With DVDs, use the ARROW buttons to navigate through the menu - left, right, up, down. VCDs normally require the use of NUMBER keys to choose menu options.



Confirm Menu Choices with ENTER

Press ENTER on the desired menu option to execute that function.

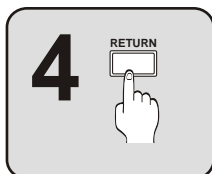

Returning to Previous Menus and Exiting

Many Disc Menus have multiple layers to navigate through. You can use the RETURN key to return to the last menu accessed.

You can Exit from most Disc Menus by pressing MENU, or following the menu options to resume playback.

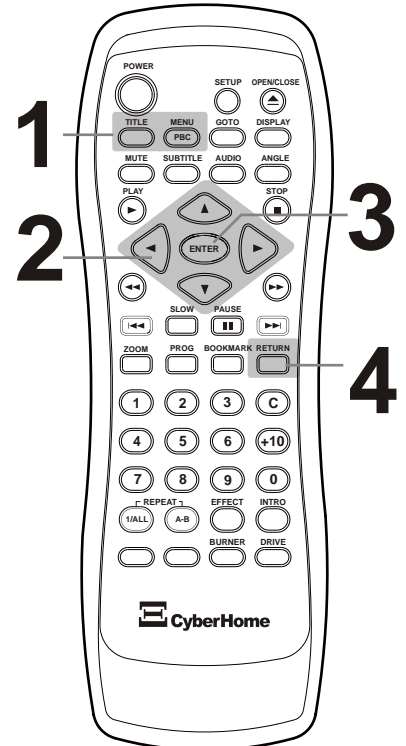

Fast Forward/Reverse & Slow Motion Scanning

Finding a Position on the Disc Using the Search Function

Your DVD Player features a Search function that will allow you to scan through video at fast or slow speeds to find a specific position. The scan functions available will depend on the type of disc you are using. With DVD discs, you may utilize all the available scanning functions, including Fast Forward and Fast Reverse, both at x2, x4 and x8 speeds, as well as Slow Motion at 1/2, 1/4 and 1/8 speeds. Audio CDs do not support Slow Motion scanning.



Fast Forward or Reverse Scanning

The Fast Forward (FF) and Fast Reverse (FR) buttons are only functional while the disc is playing. To start searching, press the button for the desired direction. The beginning scan speed is 2x, or twice the normal speed. Press the button repeatedly to cycle through all available scanning speeds. Press the PLAY button to resume normal viewing.

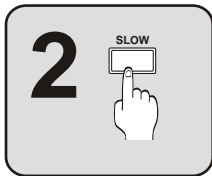

Slow Motion Scanning

With DVDs and Video CDs, you can slow the speed of playback to a mere fraction of the normal speed. While the video is playing, press the SLOW button. The playback speed will slow to 1/2 normal speed. To cycle through all speeds, continue to press the SLOW key. Press PLAY to resume normal playback.

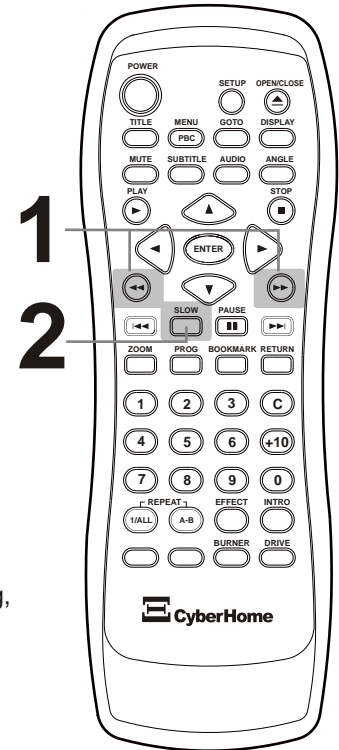

Skip Forward and Skip Back

Advancing to the Next Track or Skipping Back Through Tracks

Your DVD Player provides a convenient method for advancing or skipping back through tracks, chapters, songs or other segments on DVD, VCD or Audio CD discs.



The Next and Previous Track Buttons

Use the NEXT >>> and PREVIOUS <<< buttons to skip through the tracks on DVDs, VCDs and Audio CDs. Pressing PREVIOUS again will return to the beginning of the previous track. Advance through the remaining tracks on the disc by using the NEXT button. When the last track is reached, however, pressing NEXT will not return to the first track on the disc. This principal also holds in the reverse direction.

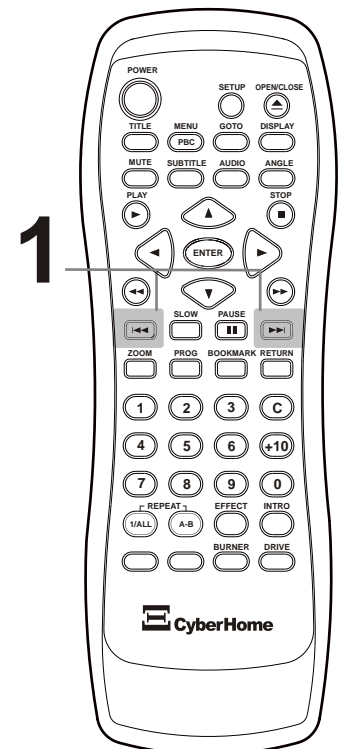

Jumping to a Specific Chapter/Track or Time Position

You may Choose a Specific Track or Time Position to Playback

There are many options available to choose the beginning playback point on DVDs, VCDs and Audio CDs. You may use the GOTO button, or enter a Track Number directly using the NUMBER buttons (CD-Audio, VCD).



Select the GOTO Button

When a DVD is playing, press GOTO to select the Title, Chapter or Time (Hours, Minutes and Seconds) of the position on the disc you wish to begin playback. Also use the GOTO menu to view the Elapsed and Remaining Time for the current Disc, Title, Chapter or Track, depending on the disc type.

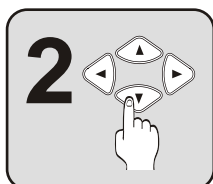

Navigating the GOTO Menu

Select the Title, Chapter, or Time categories by pressing the LEFT and RIGHT ARROW keys to move to the appropriate box. Use the UP/DOWN ARROWS to select a Title or Chapter to go to, or enter a Time Value with the NUMBER keys.



Press ENTER to Jump to the Location

Confirm your choice with the ENTER key and disc play will begin at the specified Title, Chapter or Time Value.

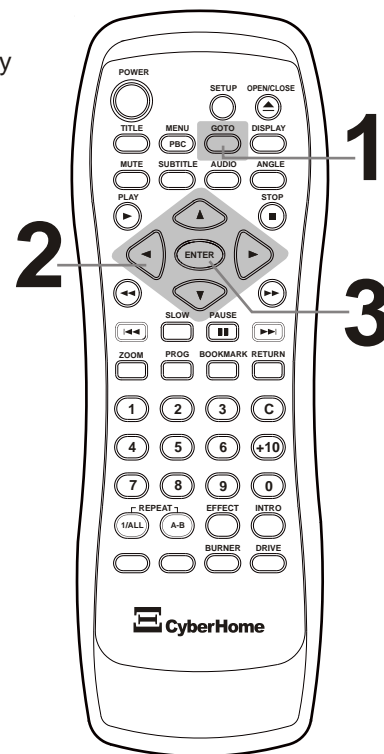

Using the Number Keys to Jump to a Track with CDs or VCD Discs

If you're using a VCD or CD, you can jump directly to a track simply by hitting the NUMBER key that corresponds with the track you wish to play.

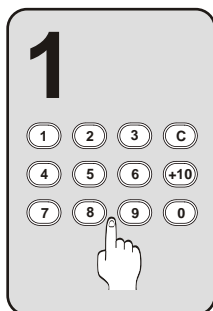

Enter Values with Number, C and +10 Buttons

With playback stopped or during playback, use the Number buttons, along with the C (Clear) and +10 keys, to enter numerical values representing Track or Chapter Number to jump to. If you wish to clear an entry, press the C button repeatedly to backspace through the digits you want to delete.

To enter a number greater than 10, press the +10 button once for each 10s value of the number. For example, if you wish to enter "32", press the +10 button three times, then press "2". The +10 key will not function when there are fewer than 10 tracks to choose from.

Quick Tips

- VCDs may require the PBC function to be disabled before directly selecting tracks with the number buttons.

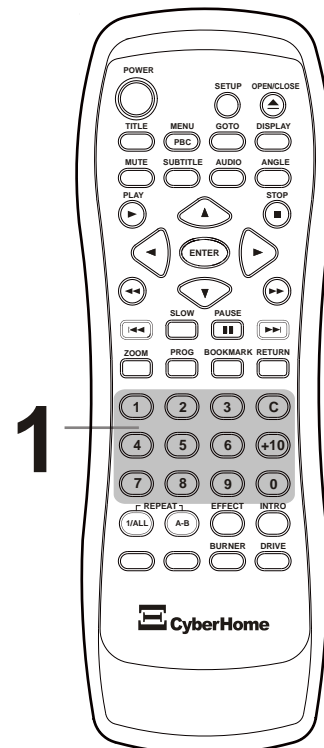

Previewing Titles, Chapters or Tracks Before Playback

See a Preview of Chapters on VCD Discs using INTRO

Your DVD Player features a great way to introduce yourself to the various content of VCD discs. Using the INTRO button, you can see a preview of all the chapters on a disc.

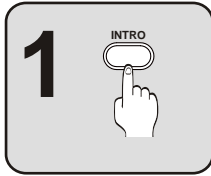

Select the INTRO Button

If you have an VCD disc inserted, press the INTRO key to see a short preview of the available tracks on the disc, along with their associated track number.

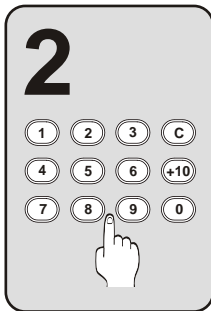

Jump to a Track with the NUMBER Keys

Use the NUMBER keys to enter the track that you would like to go to.

To enter a number greater than 10, press the +10 button once for each 10s value of the number. For example, if you wish to enter "32", press the +10 button three times, then press "2". The +10 key will not function when there are fewer than 10 tracks to choose from.

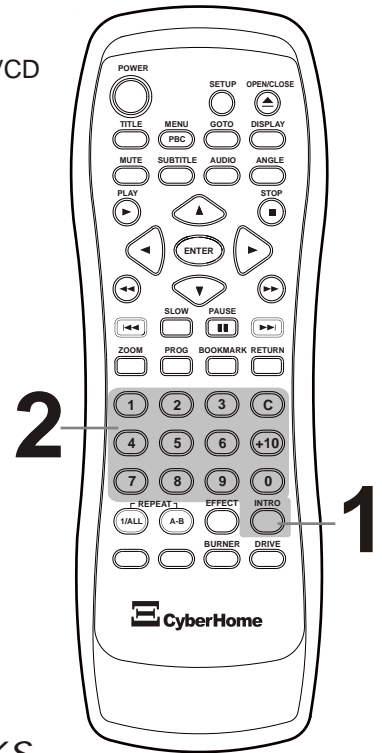

Saving Locations for Quick Play with Bookmarks

Mark Points on the Disc for Quick Play with the BOOKMARK Button

While you're watching a DVD, you can easily "mark" points on the disc that you would like quick access to later on. You can also use bookmarks with VCDs and Audio CDs.



Press the Bookmark Button

Press the Bookmark button to bring up the Bookmark Menu:



Select the Location to Store the Bookmark

Use the L/R ARROW buttons to navigate through the available Bookmark locations (1-5) to the one that you would like to save the current disc play position to. In the example here, all locations are open, so we'll choose the first one.



Press ENTER to Save the Bookmark Location

Now the play position is saved as a Bookmark in position one.

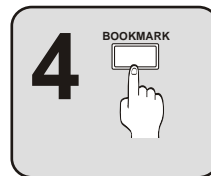

Press BOOKMARK to Exit the Bookmark Menu

Now, you can return to play the Bookmarks you've saved at any time by using the BOOKMARK button, selecting a Bookmark and pressing PLAY.

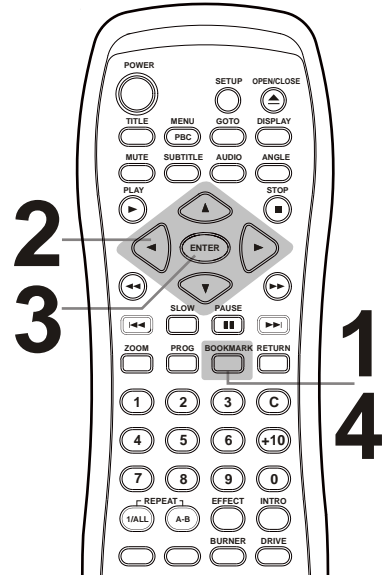

Quick Tips

- To clear Bookmarks, use the C key.
- Bookmarks are erased when the disc is ejected.

Repeating a Title, Chapter/Track or Disc

Repeat a Single Track on an Audio CD or an Entire DVD Disc

Your player has many options for repeating segments of DVDs, VCDs, and Audio CDs. This section covers how to repeat segments already defined on the disc, such as a Chapter or Track. The next section deals with creating your own segments to repeat.

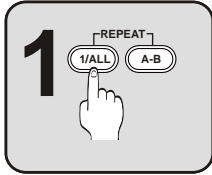

Using the REPEAT - 1/ALL Button

While you're viewing a video disc or listening to an Audio CD, press the REPEAT - 1/ALL button repeatedly to cycle through the available repeat options. The status of the repeat option will be displayed in the upper left-hand corner of the screen.



With DVDs, press the REPEAT - 1/ALL button once to repeat the Current Chapter, twice to repeat the Current Title, and three times to repeat the Entire DVD. VCDs will allow repeat playback options of the Current Chapter or All Chapters. With Audio CDs, you'll have the option to repeat the current Track or the complete CD.

To Cancel Repeat Play, press the REPEAT - 1/ALL button until the status shows OFF.

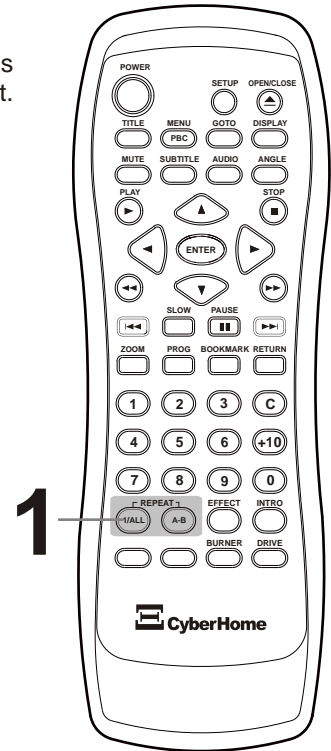

Repeating a Specific Time Segment

If you would like to repeat only a segment of an Audio Track, VCD Movie or DVD Title, simply mark the beginning and endpoints of the segment with the REPEAT A-B button.

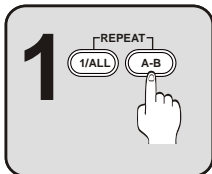

Using the REPEAT A-B Button

While viewing or listening to a disc, when you get to the point that you would like to mark as the Beginning of your repeating segment, press the REPEAT A-B button.

The following display will appear in the upper left-hand corner on the screen:

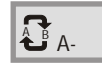

The display indicates that the start point of your repeat segment has been marked. Next, you will enter the endpoint of the segment you want to repeat.

When you reach the ending for your segment, press REPEAT A-B a second time. Now, the display reports:



This indicates that the player is in A-B Repeat mode, and will continuously play the segment you defined until you cancel repeat mode. To Cancel A-B Repeat Play, simply press the REPEAT A-B button again. The repeat status icon reports "OFF", and play continues as normal.



Quick Tips

- When using A-B Repeat with an Audio CD, your segment must be no longer than a single track.
- When using A-B Repeat with DVDs, your segment must be no longer than a single Title.

Playing Tracks in a Particular Order with Program Play

Create Custom Playback Programs of up to 30 Steps

If you would like to program the Chapters or Tracks on your VCD or CD discs to play in an order you specify, create a custom playback program with the PROGRAM button.

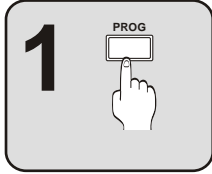

Select the PROGRAM Button during Playback

You will see the Program Menu on the screen. The track list numbers are on the left, with 30 program locations on the right.

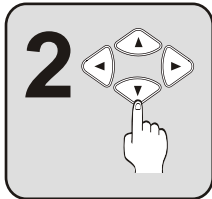
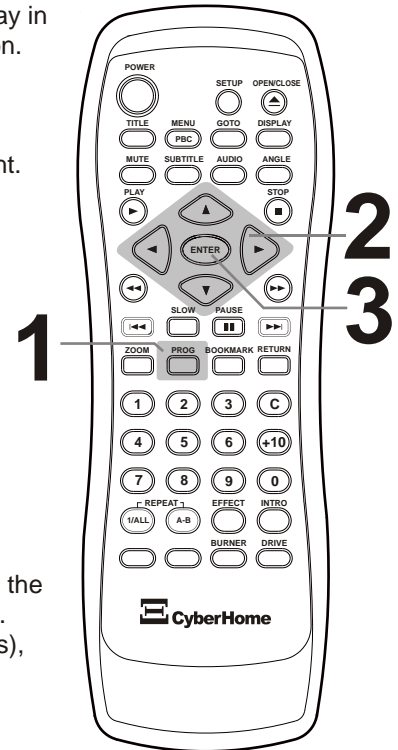
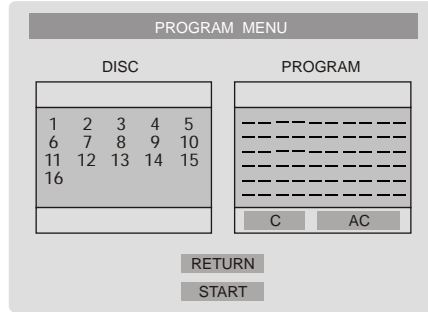

Navigate with the ARROW Buttons

Use the ARROW buttons to navigate to the Track Number on the left that you would like to add to the Program List on the right. Also use the ARROWS to go to the C (Clears individual tracks), AC (Clears All tracks), Return (Exit) or Start functions.



Add a Track to the Program List with ENTER

Hit the ENTER key on a Track Number that you want to add to the Program List. In this example, we press ENTER on track seven. Notice that it's now added to the program list.

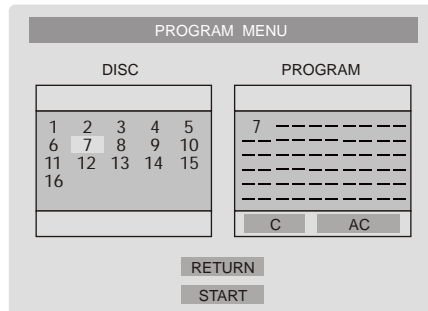

The tracks you select will play in the order they are added to, and appear in, the Program List. To Start the Program, navigate to START and press the ENTER key. The Program icon will appear on the screen, indicating Program Mode. If you wish to exit the Program Menu, select the  button.



To Stop Program Play

To switch from Program Play to normal playback, press STOP, then PLAY. Press the STOP button twice to end Program Play, reset the play position to the beginning of the disc and erase the current program.

Quick Tips

- To Resume normal playback, press STOP, then PLAY.
- Programs will be erased after the Program sequence has been completed.
- To Clear tracks from the Program, select the C function.
- To Erase the current program, navigate to AC. Press ENTER.
- Program Mode does not work with DVDs.

Playing MP3 Files with the MP3 Navigator

Your DVD Player is also a Feature-Packed MP3 Player!

When you insert an MP3 disc, the player will launch the MP3 Navigator, an on-screen program that lets you easily select and play MP3 files stored on CD-R or CD-RW discs. The MP3 Navigator gives you several options for MP3 Playback, including Repeat and Shuffle modes.

Folder List
Displays a list of all sub-folders on the Disc.

Current Track
Name of track that's currently playing.

Button List
List of buttons functional in the Media Player.

Current Folder
Displays the current folder on the disc.

Elapsed / Total Time
Shows play progress for the current track.

Repeat Mode
Displays the repeat mode, if selected.

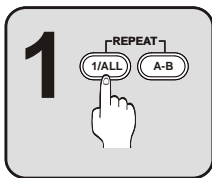

Select the Repeat Mode with REPEAT - 1/ALL

Repeat Mode gives you the option to repeat a single file, entire directory or a whole disc, as well as the option to repeat only a single file. You select from the following choices by pressing the REPEAT - 1/ALL Button:

- **[BLANK]** - Plays the files normally with no Repeat functions.
- **One** - Repeat only one file. Plays the current track in a loop.
- **Disc** - Repeats the entire disc (all tracks on the disc).
- **Dir** - Repeats all tracks in the current directory.
- **Shuffle** - Plays tracks in a random order.

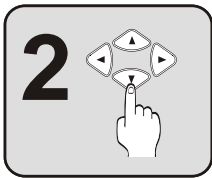

Navigate to a File or Folder

Use the arrow keys to select the File you wish to play or the Folder you want to open. To go back up the directory tree and return to a previous folder, press the LEFT ARROW key.

- Navigate Back a Directory



Press ENTER to Play

Pressing ENTER will play the selected File, Folder or Repeat Program. Also use ENTER to open folders. If no Repeat Mode is selected, pressing ENTER on a file will begin playing all files on the disc in the order they are stored.



Fast Forward/Reverse and Skip Next/Previous

You can scan through MP3 songs in Forward or Reverse direction with the FF/REV buttons. To skip ahead or back to a track, use the PREVIOUS/NEXT keys.

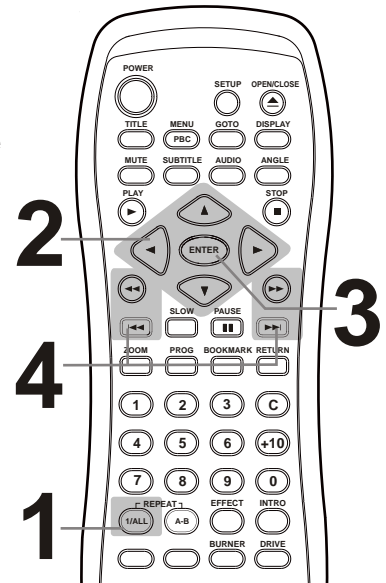

Quick Tips

- MP3 Files must be saved with the extension ".MP3" (upper or lower case) in order to play.
- You can have a maximum of 250 Files or Folders.
- MP3 Discs must have a "Closed Session" in order to play properly.

Viewing JPG Files on Your TV

You Can Play Slide-Shows of JPG Images Stored on CD-R and CD-RW Discs

When you insert a disc containing only JPG files, the player will automatically launch a Slide-Show of your images. For discs with MP3 and JPG files, the Media Player discussed on page 24 will be launched. JPG Picture files must be saved with the .JPG extension. Example: "Vacation1.jpg"

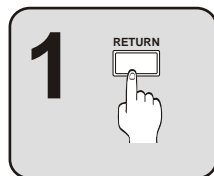
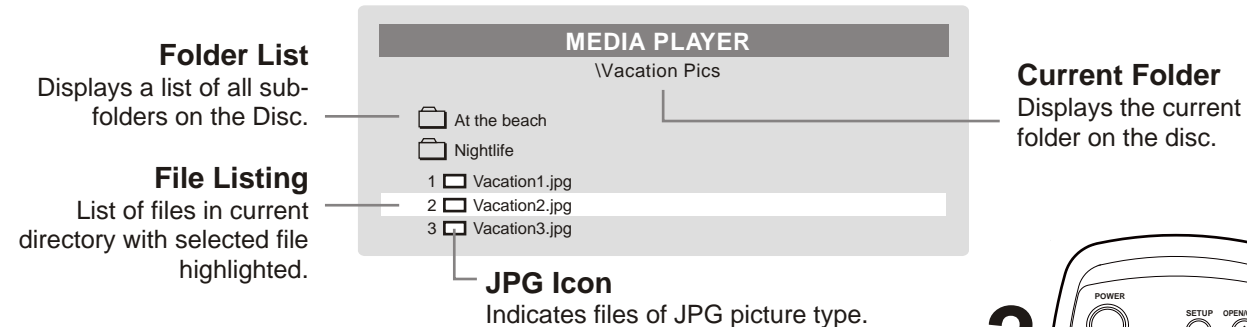

Exit the Slide-Show with RETURN

If your disc contains only JPG files, the Slide-Show will automatically start. To exit the Slide-Show and return to the Media Player, press RETURN. From the Media Player, you can select individual images for display using the ARROW and ENTER keys.

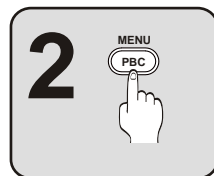

Press MENU to Begin Slide-Show Play

After you have selected a file to view and pressed ENTER, the picture will be displayed on the screen. From here, you can start Slide-Show mode by pressing the MENU/PBC button. Slide-Show mode displays all the files on the disc in the order they're stored for 5 seconds each.

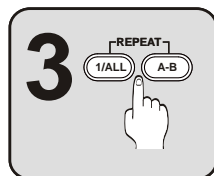

Select Slide-Show Transitions and Time Interval

You can choose from 12 types of transitions that will animate the change from one picture to the next. Transition modes are listed to the right. While the Slide-Show is in progress, press the REPEAT 1/ALL button to choose a transition type.

To adjust the Time that each picture will be displayed on-screen, press REPEAT A-B. Choices are 5, 10 or 30 Seconds.

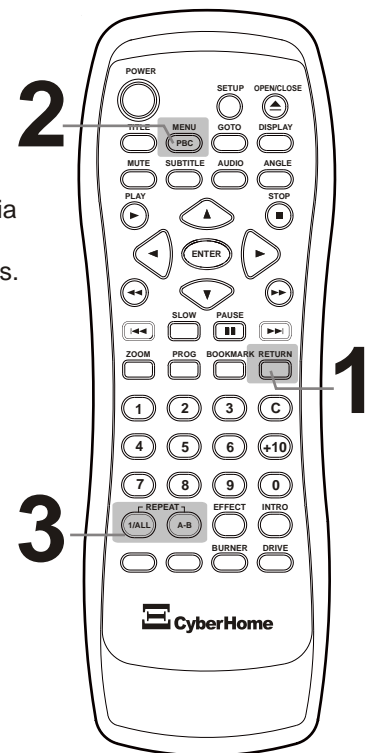

More JPG Functions

Displaying Thumbnail Images

Press RETURN to navigate to the File List Window and hit ENTER on a random file. With the picture displayed, press the INTRO button to see 9 Thumbnails of the disc images on each page. Move between pages with the SKIP NEXT and SKIP PREVIOUS keys.

Rotating and Viewing a Negative of a Photo

When a picture is displayed in non-Slide-Show mode, press the LEFT/RIGHT ARROW keys to Rotate the picture and the SLOW button to see a Negative of the image.

ZOOM Functions - Actual Size, 2X, 4X, 1/2, 1/4, Fit Screen

When a picture is displayed in non-Slide-Show mode, use the ZOOM key to cycle through a variety of magnification options. Pressing ZOOM once will display the image in Actual Size. Since the size of the typical TV screen is about 640x400 pixels, if your image is larger than this, only a part of the picture will be displayed. In this case, you can move around the picture using the ARROW keys. Press ZOOM repeatedly to view all modes - 2X and 4X Zoom In, Half and Quarter Size Zoom Out, and the default, Fit to Screen.

Quick Tips

Transition Modes

1. Top to Bottom
2. Bottom to Top
3. Top/Bottom to center
4. Middle open Up/Down
5. Vertical Blinds - Left
6. Left to Right
7. Right to Left
8. Horizontal to center
9. Center to Horizontal
10. Corners to center
11. Horizontal blinds
12. Random

Using the Zoom Function

You can Zoom In during Playback or on a Still Frame

Want to take a closer look at something you see in a DVD or VCD movie? Use the Zoom function. The Zoom function lets you enlarge the Video Image to twice the original size, while also viewing a Reference Window showing the full original picture. Zoom works on a still frame, as well as during Video Playback.

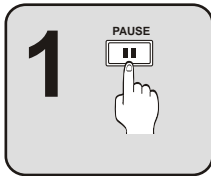

Pause Disc Playback (Optional)

Zoom is most effective if you Pause the video on a single frame to examine. However, Zoom will work while playing a movie as well. If you wish to Pause the action, press the PAUSE button.

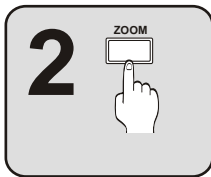

Select the ZOOM Button

Press the ZOOM button to enlarge the image - once for 2x. A Reference Window is provided to help you locate which area of the actual picture you are zoomed in on:

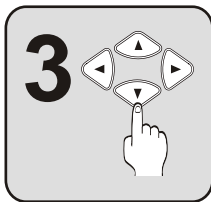
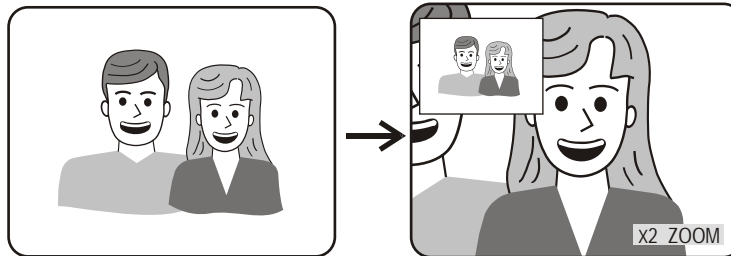

Navigate with the ARROW or NUMBER Keys

You can use the ARROW keys to move to a part of the screen you would like to see closer. Pressing the LEFT ARROW button will move the focus of the Zoom to the left, and so on.

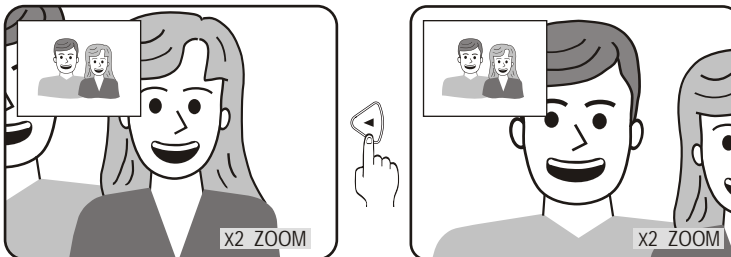

OR

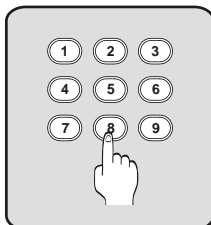

Alternatively, the NUMBER keys can be used to go directly to the location on the screen you wish to view. Each number corresponds to a specific area of the screen as shown to the right:

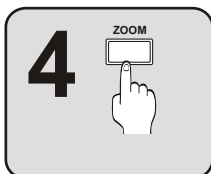
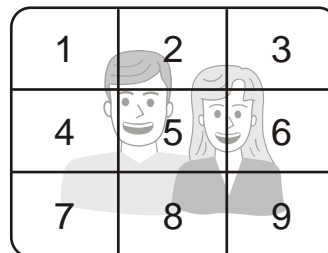

Return to Normal Viewing

Press the ZOOM button again to return to normal playback mode. The ZOOM icon disappears from the screen.

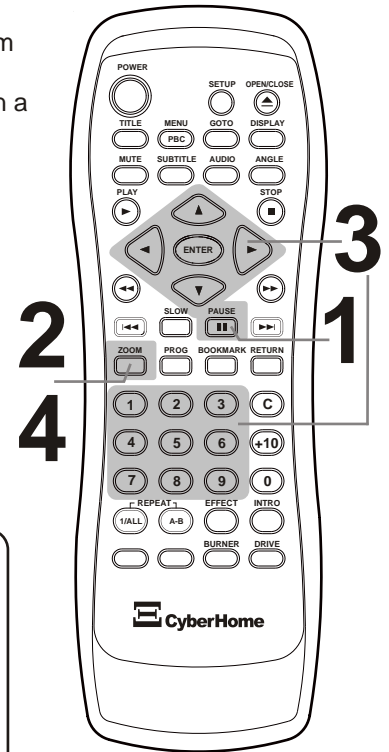

Quick Tips

- Picture quality of the Zoomed Image will depend on the quality of Video and Television
- Zoom will work only on DVDs and VCDs, not the Setup menu.

More Audio & Video Functions

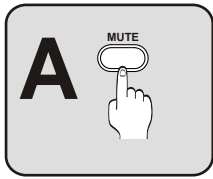

Suspending Audio with the MUTE Button

To temporarily cancel the Audio of the disc you're listening to or watching, simply press the MUTE button. You'll see an indicator on screen letting you know that the player is in MUTE mode. Press MUTE again to resume normal playback with Audio.

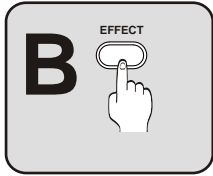

EFFECT - Bass, Treble and 3D

Use the EFFECT button to access Equalization effects for discs using Stereo soundtracks, such as VCDs and Audio CDs. The effects are not available when using DVDs, unless the disc supports a PCM Stereo Soundtrack. The Bass & Treble controls change the frequency mix of the sound, while the 3D effect simulates Surround Sound.

To use the Effect Setup, press the UP/DOWN ARROW buttons to navigate to the desired effect, then use the RIGHT/LEFT ARROW keys to adjust the sound. Press the EFFECT key again to exit the Effects Setup.

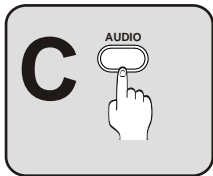

Changing Audio Settings - AUDIO Button

You can switch between the various Languages and Audio modes on DVD discs with the AUDIO button. Used with DVDs, AUDIO cycles between the languages and soundtracks available on the disc, including DTS, Dolby Digital 5.1 and Stereo Audio. Video and Audio CDs offer fewer audio options, usually including Mono Left/Right, Mix Mono and Stereo.

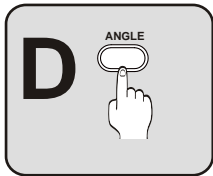

Multi-Angle Support - ANGLE BUTTON

Some DVDs are recorded with a feature called "Multi-Angle View". If you are viewing a DVD that includes this feature, press the ANGLE button to bring up the Angle Menu. Then, use the UP/DOWN ARROW keys to switch between available Angles.

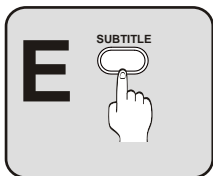

SUBTITLE - Explore Subtitle Languages

Use the SUBTITLE button with DVDs recorded with Subtitle tracks. This key will allow you to turn Subtitles On and Off, and switch between the available languages on the disc.



Use the UP/DOWN ARROW keys to select an available Subtitle Language.



Press the RIGHT ARROW button to move to the ON/OFF setting. Then, use the UP/DOWN ARROW keys to turn Subtitles On or Off.

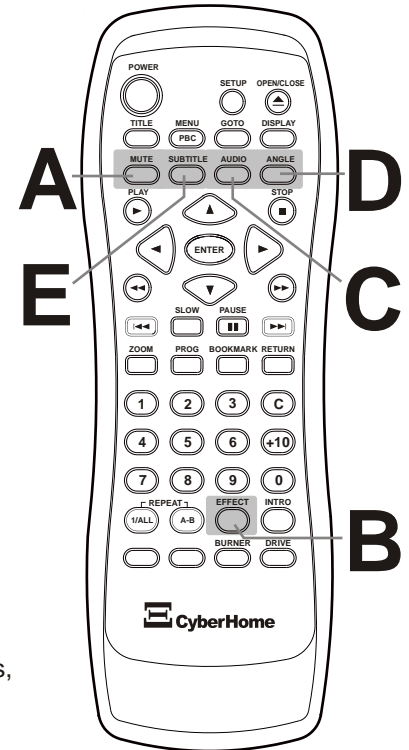

Quick Tips

- Most functions depend on the type of disc being used.
- Functions vary widely among DVD discs. The unavailable symbol will be displayed when you try to use a function that's not available on your disc.



Putting it All Together with the Display Button

Get Quick Access to Playback Information and Important Functions

Use DISPLAY to get information about the playback session, as well as direct command of some of the most important functions already discussed, all grouped together in one Menu for Quick and Easy Access. Also, with no disc in the unit, the Display key acts as a four-phase dimmer for the Player's front display (See pg 11).

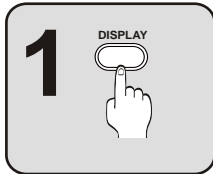

Press the DISPLAY Button while a Disc is Playing

Page one of the Display Menu will be presented across the top of the screen. To access page two, press the DISPLAY key again. A third press of the DISPLAY button will exit the menu.

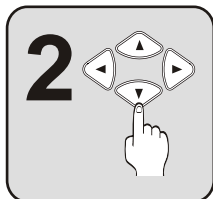

Navigate with the ARROW Buttons

Press the RIGHT/LEFT ARROW keys to move through the menu. Continue to the right to access the second page. To change the values of a setting, use the UP/DOWN ARROWS. Confirm your choices with the ENTER key. You can exit the menu at any time by pressing DISPLAY.

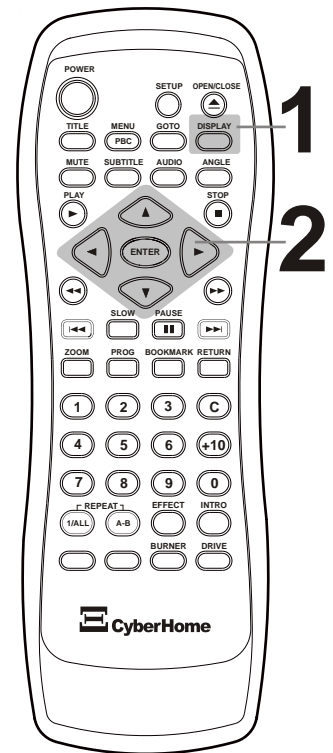

DISPLAY Menu Options with DVD, VCD and CD Audio Discs

Following is a list of functions available in the DISPLAY Menu for the most common disc types, along with the page numbers where they are discussed in-depth.

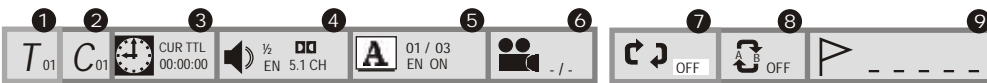

DVD	1 Jump to Title 21	6 Multi-Angle 28
	2 Jump to Chapter 21	7 Repeat Playback 23
	3 Jump to Time 21	8 A-B Repeat Mode 23
	4 Audio Settings 40	9 Bookmarks 22
	5 Subtitles 28	



VCD	1 Jump to Track 21	5 PBC On/Off 19
	2 Jump to Time 21	6 Repeat Playback 23
	3 Audio Settings 42	7 A-B Repeat Mode 23
	4 Program & Random Play . . . 24	8 Bookmarks 22



CD	1 Jump to Track 21	4 Repeat Playback 23
	2 Jump to Time 21	5 A-B Repeat Mode 23
	3 Program & Random Play . . . 24	6 Bookmarks 22

Quick Tips

- Most functions depend on the type of disc being used.
- Functions vary widely among DVD discs. The unavailable symbol will be displayed when you try to use a function that's not available on your disc.



Introduction to File Copy and Disc Duplication

Duplicate Discs, Copy Files and Record to MPEG format on the Fly

Along with supporting the latest DVD Playback functions, this unit also features a CD-RW Drive and On-Screen Burner Interface that allow for a variety of Disc Copy functions for use with CD-R/RW discs:



Disc Copy

Duplicate discs of 700MB or less capacity. Disc formats supported include CD-ROM, CDDA, Data CD, MP3, JPG and Audio CD. *Copying of DVD, SVCD and VCD discs is not supported.



Erase

Erase CD-RW discs to free up space. Quick Erase takes only 1 minute. Use Full Erase to completely wipe-out sensitive data.



File / Track Copy

Copy selected files or tracks from CD-ROM, MP3, JPG and Audio CDs to CD-R/RW discs.

CD-R/RW Supported Disc Formats

CD-Recordable (CD-R) and CD-ReWritable (CD-RW) discs of up to 700MB capacity are supported for copy and record operations. Discs of 8cm and 12cm diameter are supported.

Copy and Record Function Buttons

The following are the Remote Control and Front Panel Buttons associated with the unit's recording and copy functions. Note that the BURNER button, which brings up the Burner Interface, only exists on the Remote Control.

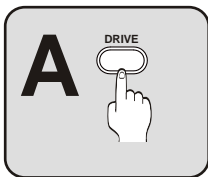

DRV (Front Panel), DRIVE (Remote Control)

Selects the working drive. When the DRIVE button is pressed, the Remote Control and Front Panel functions will be transferred to the drive selected, and any disc in the drive will be auto-read. *During copy operations, use the OPEN/CLOSE function in the On-Screen Burner Interface to open the CD-RW disc tray, rather than switching between drives with the DRV button.

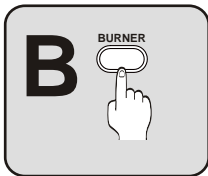

BURNER

Enters and Exits the Burner Interface. The Burner Interface is used for all Disc Copy functions. *The Burner Interface will not be accessible if a DVD, SVCD or VCD disc is inserted, due to the fact that no copy functions are supported for these types of discs.

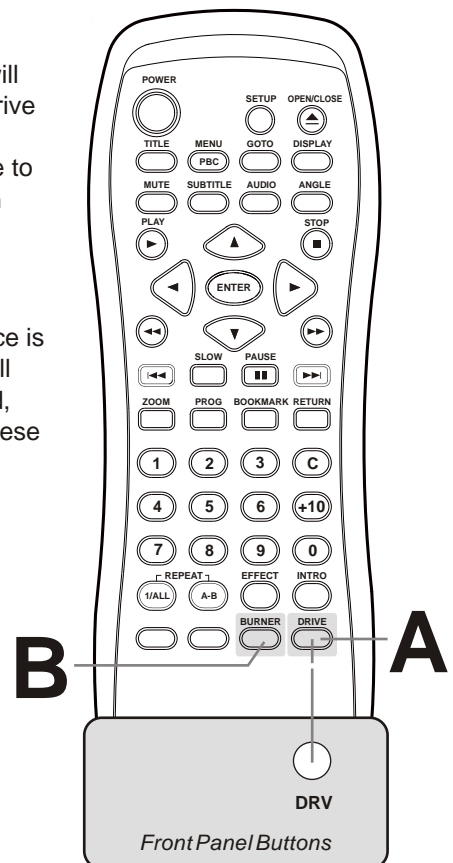

The On-Screen Burner Interface

Quickly and Easily Perform Disc/File Copy Operations

Use the Burner Interface to perform all Disc Copy operations. The Burner Interface lets you duplicate discs, select individual files or tracks to copy from one disc to another, and erase CD-RW discs in quick or full mode.

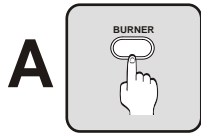

A Press BURNER on the Remote to Enter/Exit the Burner Interface.

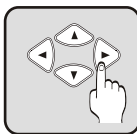

B Navigate with the ARROW keys. Use the RIGHT ARROW to move to the ICONS at the bottom of the screen.

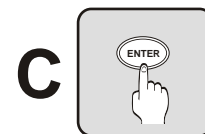
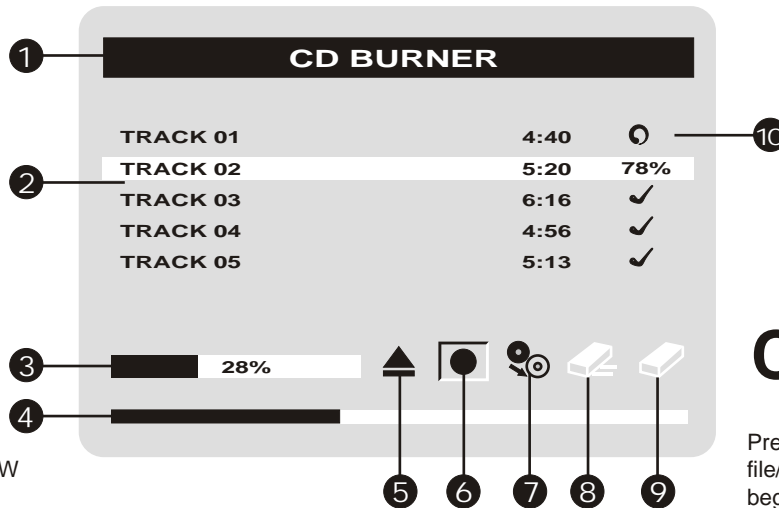

C Press ENTER to select a file/track for copy, and to begin copy/erase operations.

1 TITLE

The Title indicates the type of media that has been detected in the source (DVD) drive - MEDIA, for MP3 or ,JPG discs, or DATA CD.

2 TRACK/FILE LIST

Lists the Tracks, Files and Folders on certain types of discs. With an Audio CD disc inserted, tracks will be listed. With JPG or MP3 discs, files and folders are shown. Individual files are not displayed with Data CDs.

3 DISC TYPE / PROGRESS INDICATOR BAR

Displays the Disc Type and Free Space. While recording, shows the progress of the current copy operation in percentage completed.

4 DISC USAGE INDICATOR BAR

When a disc is inserted, the Disc Usage Indicator will show a graphical representation of the amount of disc space used, using the colors white (blank), green (small percentage of space used) and red (large percentage of space used). Also, when selecting files to copy, this bar will show a preview of the disc space that will be used for each file selected.

5 OPEN / CLOSE

Opens and Closes the CD-RW drive tray. This allows you to create multiple copies of a disc without exiting the Burner Interface. It's recommended that this function be used to insert and remove CD-R/RW discs, rather than switching between drives using the DRV button.

6 RECORD

Begins copying selected file(s). You must first select files from the track/file list using the ARROW and ENTER keys.

7 DISC COPY

Creates a duplicate of the source disc. It is recommended to use DISC COPY, rather than selecting files to copy, whenever possible. This is because by copying an entire disc, extended information such as long file names is preserved. For Data CDs, this is the only option available.

8 QUICK ERASE

The fastest way to free up a CD-RW disc for recording, this procedure only requires one minute to complete. This method erases only the Table of Contents of the disc, making the disc appear empty and allowing its data to be over-written. *If you wish to actually erase all the data on a disc, use FULL ERASE.

9 FULL ERASE

To make sure that all data on a disc is completely destroyed, use the FULL ERASE method. This procedure takes about ten minutes to complete - much longer than QUICK ERASE - and is generally used only for discs containing sensitive data.

10 STATUS

Shows the copy progress of each file in percentage completed during individual file copy operations. Three ICONS are used to display the status of files not currently being copied:

✓ **Selected for Copy:** File has been selected to be copied to the destination disc by pressing ENTER.

○ **Copy Successful:** File has been successfully copied to the destination disc.

✗ **Copy Failed:** The copy operation was not successful for this file.

Duplicating a Disc with Disc Copy

Make a Copy of a CD-ROM, Audio CD, MP3 or JPG Disc

This unit can make duplicates of most disc types, excluding DVD, SVCD and VCD discs, with capacities up to 700MB. When copying a disc, make sure the destination disc is of a large enough capacity and blank.

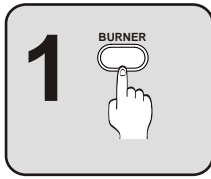

Enter the Burner Interface with the BURNER button

Insert the SOURCE disc you would like to copy into the DVD-ROM drive. If the disc auto-plays, press the STOP button twice to completely stop play. Press the BURNER button on the Remote Control to enter the On-Screen Burner Interface. The following example shows how the Burner Interface may look with an Audio CD inserted:

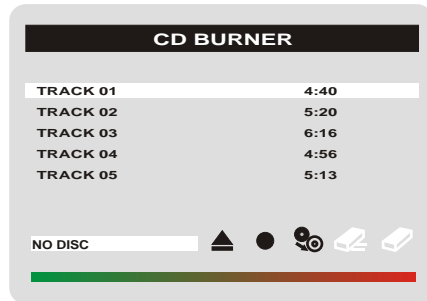

Individual files will not be listed with Data CDs, such as program discs.

Notice that the Disc Space Indicator at the bottom of the screen shows FULL, since there is no disc, hence no space available.

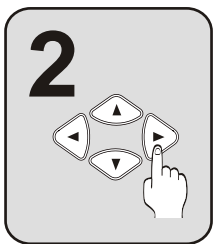
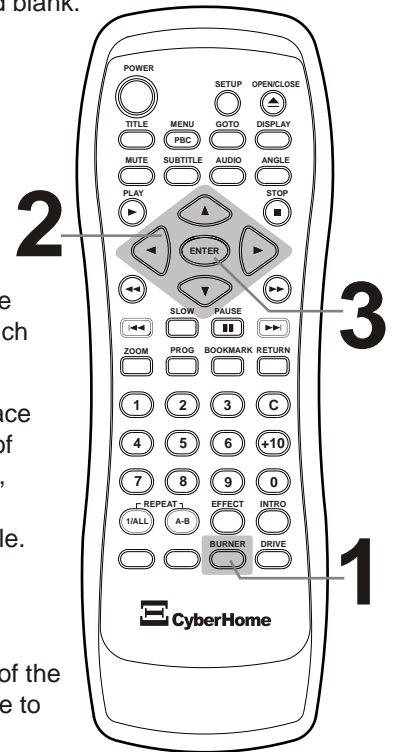

Navigate to the Open / Close Icon

Use the RIGHT ARROW key to move to the icons at the bottom of the screen. The RIGHT and LEFT ARROW keys are used to navigate to an icon. Choose the Open / Close icon ▲ and press ENTER.

Insert a CD-R or CD-RW disc in the CD-RW drive. Press ENTER again to close the tray. Notice the Disc Usage and Disc Type indicators at the bottom of the screen. The Disc Type indicator appears to the left of the icons and indicates the type of disc and amount of free space. The Disc Usage Indicator appears at the very bottom of the screen and gives a graphical representation of the amount of disc space used. For a Disc Copy, the destination disc must be blank - the Disc Usage Indicator should be completely white as shown below:

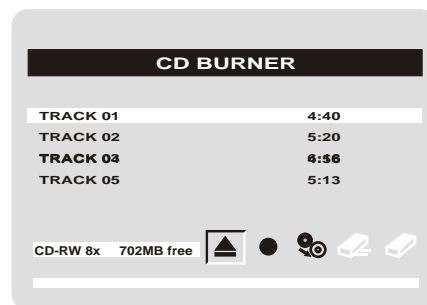

Quick Tips

- If a CD-RW disc is being used as the Destination Disc, the data on the disc can be erased using the Quick or Full Erase functions (See page 35).



Start the Disc Copy

Use the RIGHT ARROW key to select the Disc Copy icon and press ENTER to start the operation. You will be prompted to confirm the operation or cancel as shown to the left. Choose the CHECK MARK to begin, or the X to cancel.

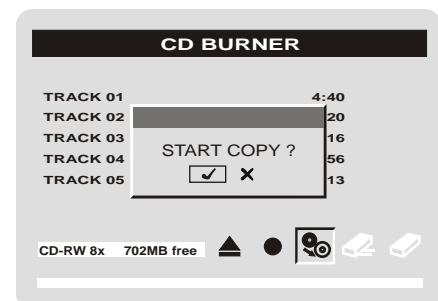

Selecting and Copying Files

You Can Select Individual Files or Tracks to Copy from One Disc to Another

Discs with MP3, Audio or JPG files allow the selection of particular files for transfer to CD-R and CD-RW discs.

*Some discs, such as Data Discs, DO NOT allow the selection of files (only a complete Disc Copy is supported on those discs).

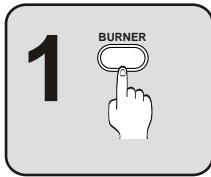

Enter the Burner Interface with the BURNER button

Insert the SOURCE disc you would like to copy into the DVD-ROM drive. If the disc auto-plays, press the STOP button twice to completely stop play. Press the BURNER button on the Remote Control to enter the On-Screen Burner Interface. The following example shows how the Burner Interface may look with an Audio CD inserted:

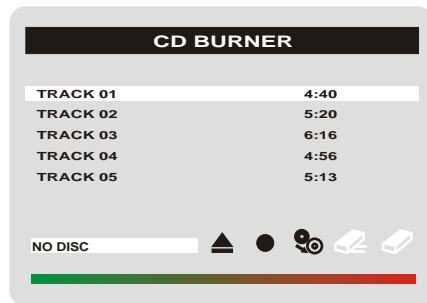

Individual files will not be listed with Data CDs, such as program discs.

Notice that the Disc Space Indicator at the bottom of the screen shows FULL, since there is no disc, hence no space available.

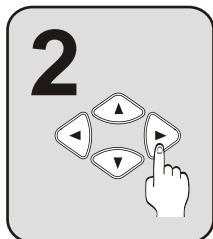
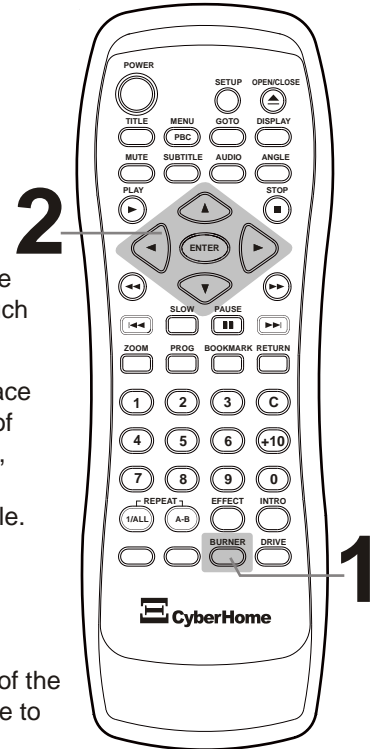

Navigate to the Open / Close Icon

Use the RIGHT ARROW key to move to the icons at the bottom of the screen. The RIGHT and LEFT ARROW keys are used to navigate to an icon. Choose the Open / Close icon ▲ and press ENTER.

Insert a CD-R or CD-RW disc in the CD-RW drive. Press ENTER again to close the tray. Notice the Disc Usage and Disc Type indicators at the bottom of the screen. The Disc Type indicator appears to the left of the icons and indicates the type of disc and amount of free space. The Disc Usage Indicator appears at the very bottom of the screen and gives a graphical representation of the amount of disc space used.

When copying selected files, the destination disc need not be completely blank. However, keep in mind that if there is already a closed session on the destination disc, a file copy operation will create a new session, resulting in a "Multi-Session" disc. *For more on Multi-Session discs, see page 36.

The following example shows a CD-RW disc with 232MB free:

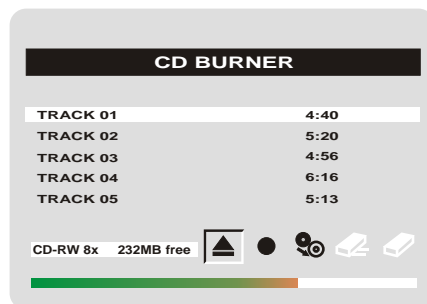

Quick Tips

- If a CD-RW disc is being used as the Destination Disc, the data on the disc can be erased using the Quick or Full Erase functions (See page 35).



Selecting and Copying Files (Cont'd)

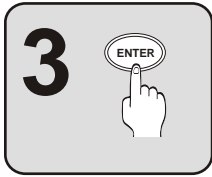

Select the Files or Tracks to Copy

Use the UP and DOWN ARROW keys to move around the files listed in the Burner Interface. To select a file or track to copy, press ENTER. A check mark will appear on files or tracks selected for copy. In the example below, we've selected the first three tracks:

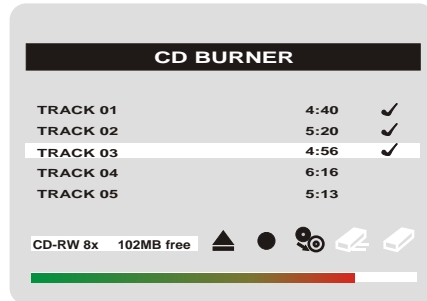

Also use the ENTER key to clear the check mark from files that have been selected for copy.

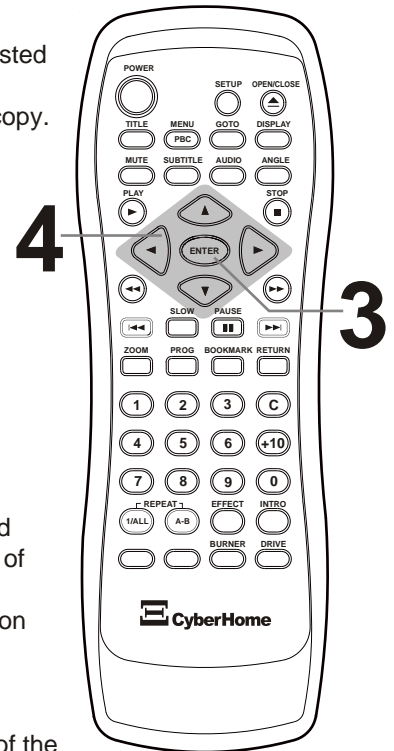

When files are selected for copying, notice that the Disc Type and Usage Indicators at the bottom of the screen will show a preview of the disc space that will be used for each file. These indicators provide a convenient method to determine how many files will fit on any given CD-R/RW disc.

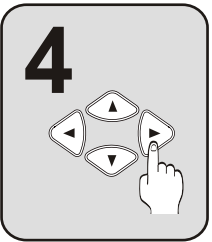

Begin the Copy Operation

Use the RIGHT ARROW key to move to the icons at the bottom of the screen. The RIGHT and LEFT ARROW keys are used to navigate to an icon. Choose the Record icon ● and press ENTER. You will be prompted to confirm the operation or cancel as shown to the left. Choose the CHECK MARK to begin, or the X to cancel.

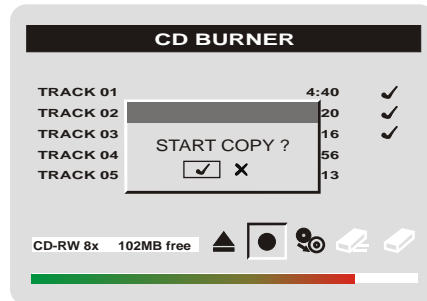

Erasing a CD-RW Disc

Easily Free-Up Space on CD-RW Discs Using the On-Screen Burner Interface

CD-RW discs are convenient to use as data storage due to their "Re-Writable" properties. This means that data can be written to a disc, then erased, so new data can take its place. To support this feature, this unit's On-Screen Burner Interface provides two ways to erase data on CD-RW discs:



Quick Erase

The fastest way to free up a CD-RW disc for recording, this procedure only requires one minute to complete. This method erases only the Table of Contents of the disc, making the disc appear empty and allowing its data to be over-written. *If you wish to actually erase all the data on a disc, use FULL ERASE.



Full Erase

To make sure that all data on a disc is completely destroyed, use the FULL ERASE method. This procedure takes about ten minutes to complete - much longer than QUICK ERASE - and is generally used only for discs containing sensitive data.

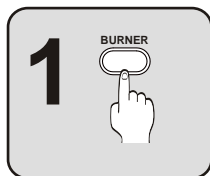

Enter the Burner Interface with the BURNER button

Press the BURNER button on the Remote Control to enter the On-Screen Burner Interface.

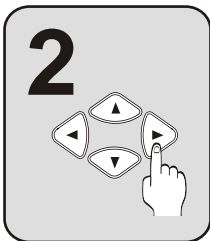

Navigate to the Open / Close Icon

Use the RIGHT ARROW key to move to the icons at the bottom of the screen. The RIGHT and LEFT ARROW keys are used to navigate to an icon. Choose the Open / Close icon ▲ and press ENTER.

Insert a CD-R or CD-RW disc in the CD-RW drive. Press ENTER again to close the tray. Notice the Disc Usage and Disc Type indicators at the bottom of the screen. The Disc Type indicator appears to the left of the icons and indicates the type of disc and amount of free space. The Disc Usage Indicator appears at the very bottom of the screen and gives a graphical representation of the amount of disc space used. In the example below, an 8X CD-RW disc is inserted with about 50% of its space used.

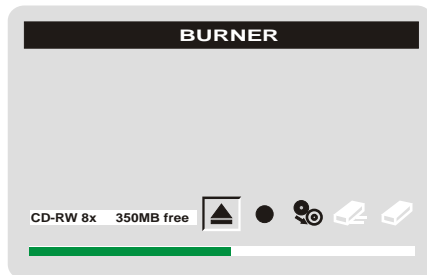

*If the Disc Type is reported as CD-R, then that disc cannot be erased.



Start the Erase Operation

Use the RIGHT ARROW key to select the Quick Erase or Full Erase icon and press ENTER to start the operation. You will be prompted to confirm the operation or cancel as shown to the left. Choose the CHECK MARK to begin, or the X to cancel.

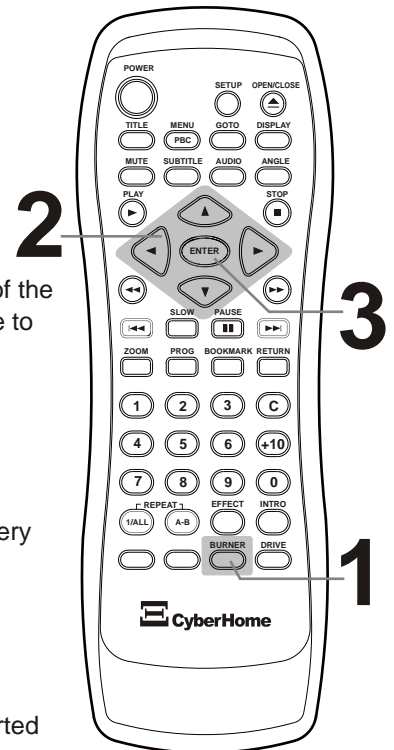
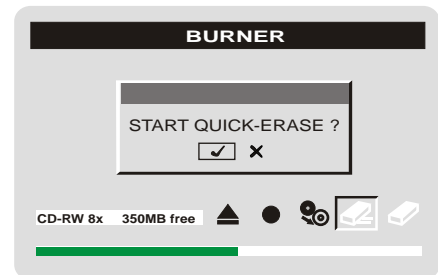

About Multi-Session Discs

Compatibility Information for Discs with Multiple Sessions

Data is recorded onto CD-R/RW discs in units known as “sessions”. A session consists of information regarding the contents of the recording, the actual data, and closing information. Using this unit, a session is created when any of the following operations are performed:

- Making a Disc Copy of a Single Session Disc
- Pressing REC in the Burner Interface to copy selected files

Once a session exists on a disc, any subsequent copying or recording operations on the same disc will result in a new session being added, thereby creating a “multi-session” disc.

Although multi-function discs are fully supported by this unit, most DVD players and many other types of optical drive products have compatibility issues and limitations regarding multi-session discs. Some common problems are:

- Only the first session is playable on some DVD Players
- Only the last session is playable on PCs
- On some DVD Players, multiple sessions may be supported in certain configurations - such as where the same type of data is contained in each session - but “mixed mode” discs, where different sessions do not contain the same type of data, are not supported.

Quick Tips

- Be sure to keep these compatibility issues in mind when working with CD-R and CD-RW discs that are destined for play on standard DVD players.
- In particular, remember that selecting the RECORD Icon and copying files or tracks will create and close a session. So, if you wish to make a single-session disc, select ALL the files you wish to copy BEFORE recording.

Selecting a Session

Working with Multi-Session Discs

This unit fully supports multi-session discs and allows for the selection of a session when the disc is first inserted, as well as during playback.

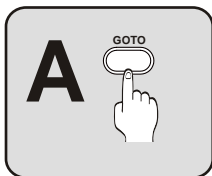

After Inserting a Multi-Session Disc

When a multi-session disc is inserted in the unit, the message “MULTISESSION CD” is displayed on the lower right of the screen, followed by the number of sessions available on the disc. While this prompt remains on screen, use the NUMBER keys to input the session number to play.

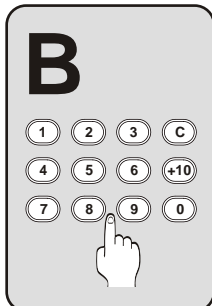

Selecting a Session During Playback

The TITLE button is used to select a session after disc playback has started. To select a session to play, press TITLE, followed by the session number.

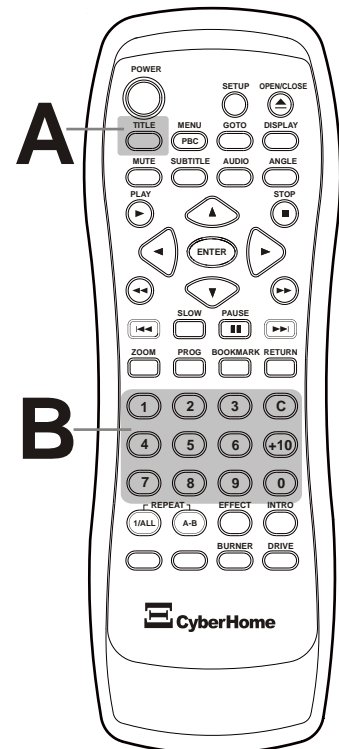

Using the On-Screen Setup Menu

Adjusting Video and Audio Settings in the DVD Player Setup

Your DVD Player features an on-screen Setup Menu that allows you to adjust settings for your Video and Audio preferences, and enable player features like Parental Lock. When you change settings in the Setup Menu, they are stored even when power is turned off. If you wish to return to the factory defaults, they can be easily reset in the OTHERS menu.

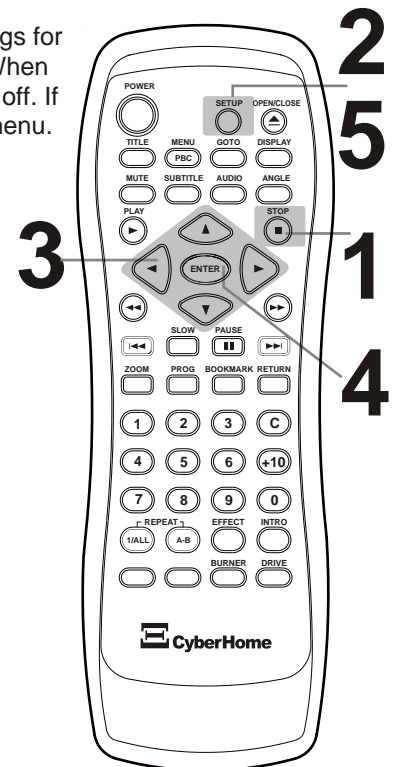

Stop Disc Play

Press the STOP button to stop play of the disc. With Audio CDs, VCDs and DVDs, after the STOP button is pressed once, the message HOLD will be displayed on front of the Player. After exiting the Setup Menu, you can resume playback where you left off.

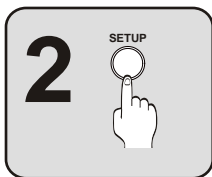

Press the SETUP Button

Press SETUP to enter the on-screen Setup Menu. The initial screen contains the following categories:

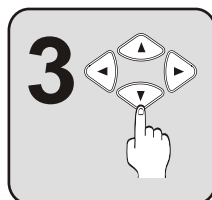
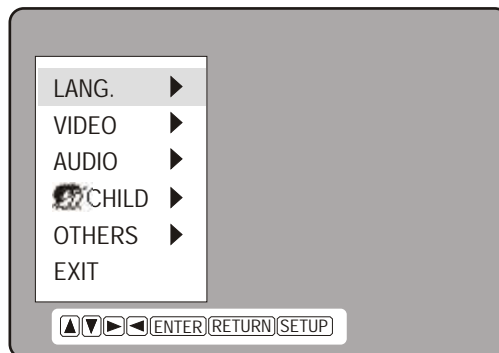

Move Around the Menu with the ARROW Keys

Use the ARROW buttons to move around the menu. In this example, we'll hit the DOWN key twice to go to AUDIO SETUP, then hit ENTER to enter that Menu. Then we'll hit the DOWN key again to select DIGITAL. Pressing the ENTER key gives us the UP/DOWN ARROWS. Now we can use the UP/DOWN ARROW keys to make a selection. In this example, we will choose LPCM. Finally, pressing the ENTER button confirms the setting.

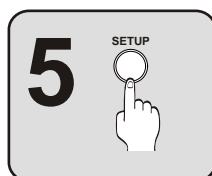
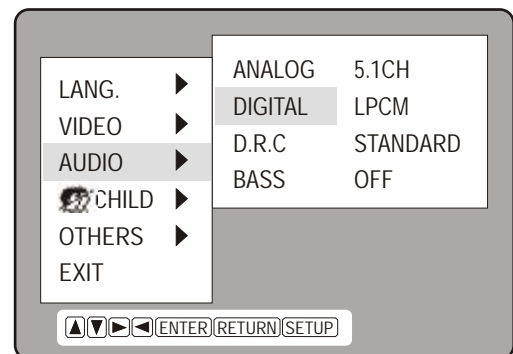
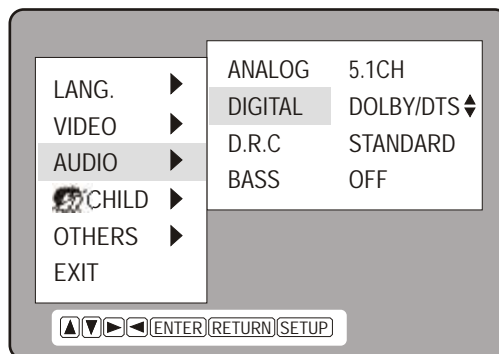
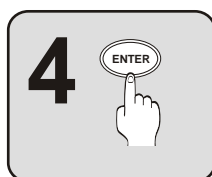

Press SETUP to Exit the On-Screen Setup Menu

You can exit the Setup menu at any time by simply pressing the SETUP key.

Parental Lock and Other Options

Exploring the CHILD and OTHERS Setup Pages

The CHILD and OTHERS Setup Pages contains many important options for your DVD player. The CHILD menu is where you can set a password to control the Parental Lock and Reset functions, which let you limit the play of discs beyond a rating you specify, and reset the settings and password to factory defaults, respectively. The OTHERS menu contains the FACTORY SETTING option, as well as the MNCOLOR setting, which allows you to change the color of the On-Screen Setup Menu.

CHILD - LEVELS 1-8

The Parental Lock allows you to limit the use of your DVD Player to only those DVD discs that do not exceed the rating you specify. When the Parental Control is set, DVD discs that support this feature will play only after the password has been entered. However, typically only discs produced by major entertainment companies support Parental Control. Discs not supporting this feature will be "immune" to Lock-Out.

When you attempt to change the Parental Control setting, you are prompted for a password. This of course makes sense, as this option would be useless if your kids could enter the Setup Menu and disable it! If there is no user password set, you'll be prompted to enter a new password. Choose a 4-Digit numeric password and write it down in case you forget it. Key in the password and press ENTER.

After the password is set, press ENTER on the CHILD option. You can choose from 8 levels of Parental Control, corresponding to the standard rating system in the USA. The available levels and their equivalent ratings are listed to the right:

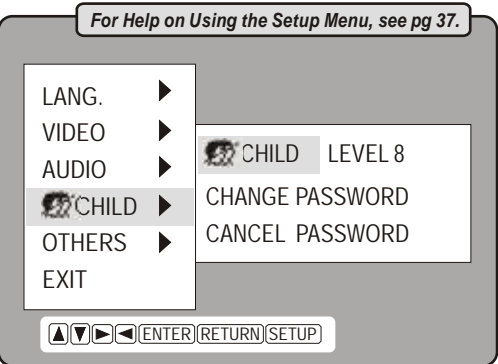

LEVEL 1. . . KIDS	LEVEL 5. . . PG R
LEVEL 2. . . G	LEVEL 6. . . R
LEVEL 3. . . PG	LEVEL 7. . . NC 17
LEVEL 4. . . PG 13	LEVEL 8. . . ADULT

CHANGE & CANCEL PASSWORD

Here is where you can change or Cancel your existing password. If you have not already entered the existing password in the Setup Menu, you are prompted for the old password. Enter the existing password for access. *If you have forgotten your password, you cannot use these options - you must reset the player to factory defaults (see below), clearing the previously entered password. After this, you can create a new password as discussed above.

MNCOLOR - BLUE / VIOLET / GREEN / YLW / ORG

Changes the Menu Color to the hue you specify.

VERSION

Displays the version of the DVD Player's FIRMWARE. This may be needed for technical reasons.

FACTORY SETTING

If you would like to return all settings of your DVD Player's Setup to the factory defaults, choose this option. All values for Audio, Video, Language, Parental Control and Password settings will be reset. When prompted for a password, enter the Default Factory Password - 3782.

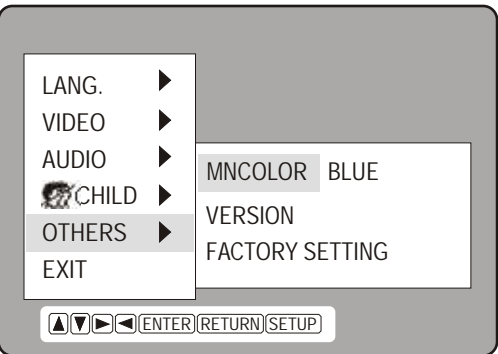

Quick Tips

- Since the factory password is listed here, the Parental Control feature may not be secure if this manual is accessible by your children.



Video Setup Options

SYSTEM - NTSC / PAL

Your DVD Player will work with TVs based on the NTSC and PAL standards, as well as TVs, Monitors and Projectors supporting Component Video Out.

NTSC is the standard TV system used in the USA, Canada, Japan and many other countries, supporting 480 Lines at 60Hz. The PAL TV system is used in Europe, Africa and the Middle East, among others, and supports 576 Lines at 50Hz.

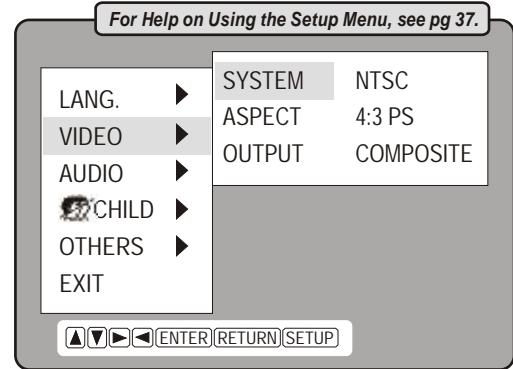

Quick Tips

Resetting to the Player's Default Video Settings

Make sure to use caution when changing the SYSTEM and OUTPUT settings. If the value selected is not compatible with your Television, you may no longer be able to see the screen. If this happens, follow the procedures below to reset the player's settings to default.



- Turn the DVD Player off using the power switch on the back of the unit.
- After a few seconds, power the player on and OPEN THE DISC TRAY.
- Enter one of the following codes on the remote control depending on your TV type:

NTSC (USA): STOP - 2 - 0 - 0 - 2

PAL (Europe): STOP - 2 - 0 - 0 - 3

- The player is now reset to COMPOSITE Video Out and the TV SYSTEM you specified.

ASPECT - 4:3 PS / 4:3 LB / 16:9 WS

You can setup your DVD Player to work with normal and wide screen televisions. If you are using a wide screen TV, set this option to 16:9 WS to match the aspect ratio of your TV. When used with a normal TV (4:3 aspect ratio), the 4:3 PS setting results in the typical "Pan & Scan" display, where a movie is clipped on the sides to fit on the TV screen. The 4:3 LB setting will enable the "Letterbox" format, where the movie is presented in wide screen format with black lines at the top and bottom of the screen.

OUTPUT - COMPOSITE / S-VIDEO / YCbCr

Change this setting to match the type of video input jack you are using on your TV.

Composite Video is the most common video connection type and is supported on most TVs. S-Video is a higher quality video signal that is separated into brightness and color channels. YCbCr, or COMPONENT video is used for TVs, Computer Monitors and Projectors that support three video inputs, one for a color channel (Yellow, Blue, Red).

Audio Setup Options

ANALOG - 5.1CH / 2CH

The ANALOG setting controls the DVD Player's Analog Audio Outputs. These are the Stereo Audio and 5.1 Channel Outputs covered on pages 11, 13 & 15. Select 5.1CH if you are using the 5.1 Channel outputs to connect to a Dolby-Ready Receiver or Speaker System. If you are using a TV for audio or a stereo system with only two channel inputs, this setting should be switched to 2CH, allowing you to hear all channels of Dolby/DTS 5.1 soundtracks through two speakers.

DIGITAL - DOLBY / DTS / LPCM

Most DVDs are produced with Dolby or DTS 5.1 Channel soundtracks. So, normally this setting should be at the default of DOLBY/DTS. However, this setting can be set to LPCM to support DVDs featuring this type of audio format. LPCM, or Linear Pulse Code Modulation, is a stereo digital audio format typically used only with CD audio.

D.R.C - STANDARD / MAXIMUM / TV MODE

Sometimes called "midnight mode", D.R.C (Dynamic Range Compression) aims to make watching a movie at low volumes more enjoyable by boosting the quieter sounds while suppressing the louder sounds. This reduction in the difference between the low and high audio levels is known as "compression". You can adjust the level of this compression in three levels: MAXIMUM - Highest compression, STANDARD - Normal compression, and TV MODE - Optimized for smaller speakers.

BASS - OFF / SMALL / LARGE

You can tailor the bass response of your Sub-Woofer different room sizes with the BASS setting. The options are: OFF - No additional processing of the sub-woofer signal, SMALL - Adjusts the sub-woofer output for small rooms, and LARGE - Adjusts the sub-woofer output for large rooms.

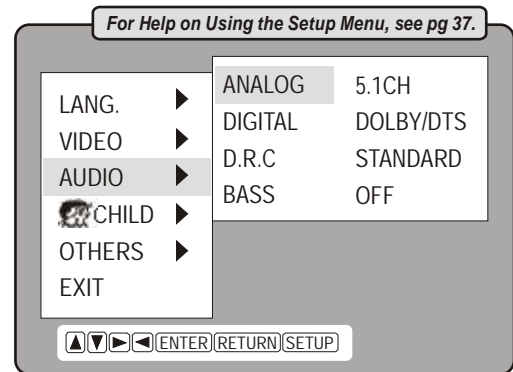

Language Setup Options

Setting Language Options for Setup and DVDs

The Language Setup Page allows you to change the language the player will use for the On-Screen Display (OSD), as well as the default language for movies with multiple language tracks. Keep in mind that if the DVD you're using does not support the language you choose, the default of the disc will be used. This also applies to Subtitle and Disc Menu settings.

O.S.D - DEUTSCH / ESPAÑOL / ITALIANO / FRANCAIS

With this setting you can change the language of the On-Screen Display menus. This will make it easier to change other options with the Setup Menu if English is not your native language.

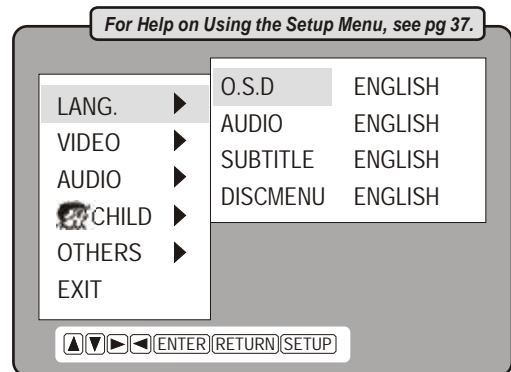

AUDIO, SUBTITLE & DISCMENU - ENGLISH / GERMAN / SPANISH / ITALIAN / FRENCH / CHINESE / ORIGINAL / USER-DEFINED

You can set the player to use a preferred language for DVD Audio Tracks, Subtitles and Menus. Of course, these settings will only take effect for DVD discs that support the language you have chosen. If the DVD discs do not support your preferred language, the default for the disc will be used instead. These menus also have the choice of a User-Defined Option. Refer to the following language codes to input a language not listed.

Language Codes

6565	Afar	7165	Irish	7775	Macedonian	8387	Swahili
6566	Abkhazian	7168	Scots/Gaelic	7776	Malayalam	8465	Tamil
6570	Afrikaans	7176	Galician	7778	Mongolian	8469	Tegulu
6577	Amharic	7178	Guarani	7779	Moldavian	8471	Tajik
6582	Arabic	7185	Gujarati	7782	Marathi	8472	Thai
6583	Assamese	7265	Hausa	7783	Malay	8473	Tigrinya
6588	Aymara	7273	Hindi	7784	Maltese	8475	Turkmen
6590	Azerbaijani	7282	Croatian	7789	Burmese	8476	Tagalog
6665	Bashkir	7285	Hungarian	7865	Nauru	8479	Tonga
6669	Byelorussian	7289	Armenian	7869	Nepali	8482	Turkish
6671	Bulgarian	7365	Interlingua	7876	Dutch	8484	Tatar
6672	Bislama	7378	Indonesian	7879	Norwegian	8487	Twi
6678	Bengali	7383	Icelandic	7982	Oriya	8575	Ukrainian
6679	Tibetan	7384	Italian	8065	Punjabi	8582	Urdu
6682	Breton	7387	Hebrew	8076	Polish	8590	Uzbek
6765	Catalan	7465	Japanese	8083	Pashto/Pushto	8673	Vietnamese
6779	Corsican	7473	Yiddish	8084	Portuguese	8679	Volapuk
6783	Czech	7487	Javanese	8185	Quechua	8779	Wolof
6789	Welsh	7565	Georgian	8277	Rhaeto-Romance	8872	Xhosa
6865	Danish	7575	Kazakh	8279	Romanian	8979	Yoruba
6869	German	7576	Greenlandic	8285	Russian	9072	Chinese
6890	Bhutani	7577	Cambodian	8365	Kinyarwanda	9085	Zulu
6976	Greek	7578	Kannada	8368	Sanskrit		
6978	English	7579	Korean	8372	Serbo-Croatian		
6979	Esperanto	7583	Kashmiri	8373	Singhalese		
6983	Spanish	7585	Kurdish	8375	Slovak		
6984	Estonian	7589	Kirghiz	8376	Slovenian		
6985	Basque	7665	Latin	8377	Samoan		
7065	Persian	7678	Lingala	8378	Shona		
7073	Finnish	7679	Laothian	8379	Somali		
7074	Fiji	7684	Lithuanian	8381	Albanian		
7079	Faeroese	7686	Latvian/Lettish	8382	Serbian		
7082	French	7771	Malagasy	8385	Sundanese		
7089	Frisian	7773	Maori	8386	Swedish		

Troubleshooting Common Problems

The DVD Player Does Not Power On

- The AC Power cord may be loose or not plugged in. Make sure the power cord is secure in the AC socket and the connector on the back of the player.
- The unit may be in Standby Mode. Turn the player on with the remote POWER button, or turn the unit off with the back power switch, wait for a few seconds, then turn the unit back on.
- There must be a pause between powering the unit down and back on of a few seconds.

A Specific Disc Does Not Play

- The disc may be dirty. Try cleaning the disc.
- Make sure the disc is not in upside-down
- The region code of the disc may not match that of the player. In this case, the disc cannot be used.

The Remote Control Does Not Function

- Make sure you're aiming the remote directly at the player's remote sensor, located in the front display.
- Make sure there are no obstacles between the remote and the player.
- The batteries may be drained. Try changing the batteries in the remote.
- You could be using the remote too far away. Try within 4 meters of the player.

There is No Picture on the TV Screen

- Make sure the connections from the player to the TV are secure.
- Verify that the TV's channel is set to match the video input you're using. Refer to the TV's documentation.
- On most TVs the "Aux In", "Video In" or "A/V In" channel should match the video input connector.
- If you're using the S-Video connector, the TV may have a separate input channel for this type.

The Picture Appears Stretched or Squeezed

- The Video Aspect Ratio may be set wrong for your Television type.
- Enter the Setup Menu and select the Video Menu. Try changing the ASPECT setting to 4:3 PS (Pan&Scan) if you are using a standard TV, or 16:9 WS if your TV is a Wide-Screen type.

The Disc Doesn't Eject

- If the player is in Standby Mode, the disc will not eject. Turn the player on with the Remote Control and then eject the disc.

No Sound from TV or Speakers

- If the DTS soundtrack is enabled in the DVD Disc Menu, but you are using Stereo Analog audio, the sound will not work. Try switching the soundtrack to Dolby/DTS 5.1 or PCM mode in the Disc Menu.
- If you are using a Digital Receiver, check the Dolby/DTS setting in the player's Setup Menu (pg 40).
- Make sure the audio cables connecting the DVD player to your TV or receiver are secure.
- The movie is paused. There is no sound during Pause or Search modes.

Sound From Only Left/Right Front Speakers of 5.1 Channel System

- If you're using the 5.1 Channel Analog Outputs, check the ANALOG setting in the DVD Player's Setup Menu (pg 40). This setting should be set to 5.1CH.
- Use the MENU key to enter the disc's menu and check that the Audio Setup is set to Dolby/DTS 5.1 Audio.
- Make sure the DIGITAL setting is on DOLBY/DTS in the Player Setup Menu. (See pg 40)

Distorted Picture when Connected to a VCR

- This DVD Player is built with Macrovision copy-protection. This will distort the signal when used with VCRs. Connect the player directly to the TV.

Specifications

Playable Discs

DVD, SVCD, VCD, Audio CD, CD-R, CD-RW, JPG, MP3

TV Systems Supported

NTSC, PAL

Record Capability

Direct disc-to-disc duplication and selected file/track copy for CD-DA, MP3 and Data discs

Multi-Session Recording: Combine MPEG, MP3 and JPG sessions on a single disc

Laser

Semiconductor Laser, wavelength 650nm

Frequency Response (Digital Audio)

DVD Linear Sound: 48kHz sampling 4Hz to 22kHz

96kHz sampling 4Hz to 44kHz

Audio CD: 4Hz to 20kHz

Signal-to-Noise Ratio (Digital Audio)

More than 90dB

Audio dynamic range (Digital Audio)

More than 80dB

Harmonic Distortion (Digital Audio)

Less than 0.015%

Wow and Flutter

Less than $\pm 0.001\%$ (W.PEAK)

Connections

Component Video Out: (Y) 1.0Vpp (75 Ohm), Negative Sync, (Pb)/(Pr) .7 Vpp (75 Ohm)

S-Video Out: Mini DIN 4-Pin (75 Ohm)

Video Out: One Pin Jack, 1Vpp (75 Ohm)

Coaxial Digital Out: One Pin Jack, .5Vpp (75 Ohm)

Analog Audio Out: Two Pin Jacks, 2.0VRMS (470 Ohm)

Operating Conditions

5°C to 35°C (41°F to 95°F), Operation Status: Horizontal

Power Supply

AC 120V, 60Hz

Power Consumption

Normal Mode: 17W

Standby Mode: 4.8W

Dimensions

430mm (L) x 69mm (H) x 340mm (D)

Weight

8.5 kg.

**Note: Design and specifications are subject to change without notice.*

Glossary of DVD-Related Terms

CD-R & CD-RW

Recordable Optical Disc formats that can be used as VCD, MP3 or JPG discs with your DVD Player.

Coaxial Digital Audio Connector

A digital audio connection used to connect a DVD player to a receiver or pre-amplifier. Transfers a "RAW" (encoded) digital audio signal, minimizes signal degradation.

Component Video

Offers the best interface between a video signal source and a TV. Uses three RCA-type jacks to separate the component signals making up a video signal. A component video signal is comprised of the luminance (Y) signal and separate chrominance (PR and PB) signals.

Composite Video

The most common connection between a DVD Player and a video display, Composite Video uses a single RCA cable.

Dolby Digital 5.1

A digital surround sound system, capable of transferring up to 5 sound channels plus a sub-bass woofer, developed by Dolby Labs. Supported on most DVD discs.

DTS

Digital Theater System. Another digital surround sound system with 5.1 channels. DTS is supported on some newer DVD discs.

Dual-Layer DVD

A DVD disc that has two layers on each side. A single-sided, dual-layered DVD can hold almost four hours of video and audio, and is also known as a DVD-9.

DVD

Digital Video Disc. DVDs come in different formats, such as single-sided or double-sided. Each side can have a single layer or two layers of data.

DVD-5

A DVD that is single-sided, single-layer, holding up to 4.7 GBytes of data.

DVD-9

A DVD that is single-sided, dual-layer, holding up to 8.5 GBytes of data.

DVD-10

A DVD that is double-sided and single-layered, which holds up to 9.4 GBytes of data. This disc must be manually flipped to use both sides.

Home Theater

A system designed to re-create the movie theater experience in the home. A typical home theater system will have a DVD Player, TV, Receiver and Speaker System with 4 speakers and a subwoofer for surround sound.

Interlaced Scanning

Most Televisions use Interlaced scanning, drawing only odd or even lines with each pass.

Glossary of DVD-Related Terms (cont'd)

LPCM

Linear PCM is a method of digital audio storage typically used with CD Audio. This format is sometimes used on DVD discs - at a higher resolution than CD - for stereo soundtracks.

MacroVision

Analog Copy Protection which scrambles video signal when used with VHS recorders. Also has an effect on some projectors and monitors.

MP3

A compressed audio format. Its small size makes it popular for downloading on internet. MP3 files recorded on CD-R or CD-RW media are suitable for playback on your DVD Player.

NTSC

National Television System Committee. This is the standard system for TV in the USA and Japan, among others.

PAL

Video standard used in most European countries and elsewhere.

Progressive Scan

Scans all horizontal lines of a monitor or TV display in one pass, as opposed to Interlaced, which scans only odd or even lines with each pass.

Region Code

DVD movies are produced with region encoding to restrict distribution of titles to certain areas at certain times. To play back a DVD title with a specific region code, you will need a DVD player with the same region code.

S-Video

S-Video offers significantly improved video signal performance over a basic composite video connection. To use this type of connection, your TV must have an S-Video input.

VCD

Digital Video Disc. A digital video disc format particularly popular in Asia. Uses MPEG-1 video compression. The picture quality is roughly that of VHS tapes.

Copyright Protection

This product incorporates copyright protection technology that is protected by method claims of certain U.S. Patents and other intellectual property rights owned by Macrovision Corporation and other rights owners. Use of this copyright protection technology must be authorized by Macrovision Corporation, and is intended for home and other limited viewing uses only unless otherwise authorized by Macrovision Corporation. Reverse engineering or disassembly is prohibited.

Manufactured under license from Dolby Laboratories. Dolby and the double-D symbol are trademarks of Dolby Laboratories. Confidential Unpublished Works.
© 1992-1997 Dolby Laboratories, Inc. All rights reserved.
All trademarks are the property of their respective owners.

Index

a-b repeat.....	23	next track button	8
a-b repeat button.....	9	number buttons	9
angle button	8	open/close button.....	8
angles (multi-angle playback)	28	pause button	8, 18
arrow buttons	8	parental lock.....	38
audio button	8	password.....	38
audio cd	5	play button	8, 17
audio outputs.....	12	power button	8
audio settings.....	40	power cord	3, 12
back panel.....	12	power switch	10, 12
batteries	7	preview.....	22
bookmark button	9	previous button	8
bookmarks	22	prog button.....	9
burner button.....	30	program play	24
burner interface.....	31	random playback.....	29
c (clear) button	9	remote control	
coaxial output.....	12, 16	preparing.....	7
component video output.....	12, 15	buttons	8-9
composite video output	12, 14	using	7
connections.....	12, 13-16	repeat buttons	9
copying.....	30, 33	repeat playback.....	23
dimmer	11	resetting player	
disc copy	32	video output	39
discs.....	5, 6	factory defaults.....	38
display button	8, 11, 29	return button.....	9
display panel	11	reverse button	8
drive button	30	safety precautions.....	3
effect button	9	screen saver	18
effects.....	28	setup button	8
enter button.....	8	setup menu	37-41
erase	30, 35	skip ahead/back	20
factory default settings	38	slow button.....	8
fast forward button	8	slow motion playback.....	20
features	5	specifications	43
front panel	10	standby power.....	17
glossary	44-45	still picture	18
goto	8, 21	stop button	8, 18
index	46	subtitle button.....	9
interference	3	s-video output	12, 14
intro	22	table of contents.....	4
intro button	9	title button	8
jpg files.....	26	troubleshooting	42
language settings.....	41	video outputs.....	12
menu button	8	video settings	39
menus	19	zoom button	9
mp3	5, 25	zoom playback	27
multi-session	36		
mute button	8		

Free Manuals Download Website

<http://myh66.com>

<http://usermanuals.us>

<http://www.somanuals.com>

<http://www.4manuals.cc>

<http://www.manual-lib.com>

<http://www.404manual.com>

<http://www.luxmanual.com>

<http://aubethermostatmanual.com>

Golf course search by state

<http://golfingnear.com>

Email search by domain

<http://emailbydomain.com>

Auto manuals search

<http://auto.somanuals.com>

TV manuals search

<http://tv.somanuals.com>