

INSPIRON™

SETUP GUIDE



YOURS IS HERE

INSPIRON™

SETUP GUIDE

Model PP19S

Notes, Cautions and Warnings



NOTE: A NOTE indicates important information that helps you make better use of your computer.



CAUTION: A CAUTION indicates either potential damage to hardware or loss of data and tells you how to avoid the problem.



WARNING: A WARNING indicates a potential for property damage, personal injury, or death.

Information in this document is subject to change without notice.

© 2008–2009 Dell Inc. All rights reserved.

Reproduction of these materials in any manner whatsoever without the written permission of Dell Inc. is strictly forbidden.

Trademarks used in this text: *Dell*, the *DELL* logo, *Inspiron*, *YOURS IS HERE*, and *DellConnect* are trademarks of Dell Inc.; *Intel* is a registered trademark and *Atom* is a trademark of Intel Corporation in the U.S. and other countries; *Microsoft*, *Windows*, *Windows Vista*, and the *Windows Vista* start button logo are either trademarks or registered trademarks of Microsoft Corporation in the United States and/or other countries; *Bluetooth* is a registered trademark owned by Bluetooth SIG, Inc. and is used by Dell under license; *SRS Premium Sound*, *SRS*, and the (O) symbol are trademarks of SRS Labs, Inc.

Other trademarks and trade names may be used in this document to refer to either the entities claiming the marks and names or their products. Dell Inc. disclaims any proprietary interest in trademarks and trade names other than its own.

April 2009

P/N R891K

Rev. A01

Contents

Setting Up Your Inspiron™ Laptop	5	Touch Pad Gestures	20
Before Setting Up Your Computer	5	Setting the Touch Pad Sensitivity	22
Connect the AC Adapter	6	Display Features	23
Connect the Network Cable (Optional)	7	Removing and Replacing the Battery	24
Press the Power Button	8	Software Features	25
Enable or Disable Wireless (Optional)	9	Solving Problems	27
Ubuntu® Setup	10	Network Problems	27
Microsoft® Windows® Setup	10	Power Problems	28
Connect to the Internet (Optional)	10	Memory Problems	29
Set Up the TV Tuner (Availability Varies by Regions)	13	Lockups and Software Problems	30
Using Your Inspiron™ Laptop	14	Using Support Tools	32
Right Side Features	14	Dell Support Center	32
Left Side Features	16	System Messages	33
Computer Base and Keyboard Features	18	Hardware Troubleshooter	34
		Dell Diagnostics	35

Contents

Restoring Your Operating System	37	Finding More Information and Resources	50
System Restore	37	Specifications	52
Using Dell™ PC Restore in Windows XP	39	Index	60
Dell Factory Image Restore	41		
Operating System Reinstallation	42		
Getting Help	44		
Technical Support and Customer Service	45		
DellConnect™	45		
Online Services	45		
Automated Order-Status Service	46		
Product Information	46		
Returning Items for Repair Under Warranty or for Credit	47		
Before You Call	48		
Contacting Dell	49		

Setting Up Your Inspiron™ Laptop

This section provides information about setting up your Inspiron Mini 10 laptop.

Before Setting Up Your Computer

When positioning your computer, ensure that you allow easy access to a power source, adequate ventilation, and a level surface to place your computer.

Restricting airflow around your Inspiron laptop may cause it to overheat. To prevent overheating ensure that you leave at least 10.2 cm (4 inches) at the back of the computer and a minimum of 5.1 cm (2 inches) on all other sides. You should never place your computer in an enclosed space, such as a cabinet or drawer when it is powered on.

 **WARNING:** Do not block, push objects into, or allow dust to accumulate in the air vents. Do not place your Dell™ computer in a low-airflow environment, such as a closed briefcase, while it is powered on. Restricting the airflow can damage the computer or cause a fire.

 **CAUTION:** Placing or stacking heavy or sharp objects on the computer may result in permanent damage to the computer.

Connect the AC Adapter

Connect the AC adapter to the computer and then plug it into a wall outlet or surge protector.

⚠ WARNING: The AC adapter works with electrical outlets worldwide. However, power connectors and power strips vary among countries. Using an incompatible cable or improperly connecting the cable to a power strip or electrical outlet may cause fire or permanent damage to your computer.

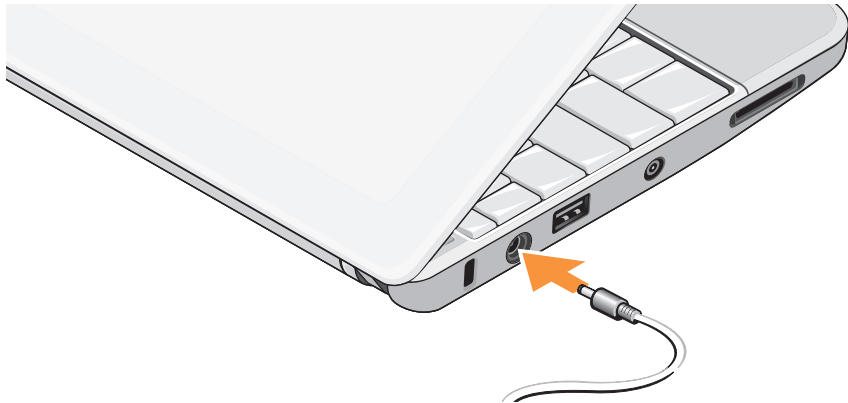

Connect the Network Cable (Optional)

To use a wired network connection, connect the network cable.



Press the Power Button



Enable or Disable Wireless (Optional)

To enable wireless:

1. Turn on your computer.
2. Double-click the  icon on the system tray or press <F2>.

The **Wireless Enable/Disable** dialog box appears.

3. Select the option(s) you want to enable:
 - **Enable Bluetooth**
 - **Enable Wireless LAN/WiMax**
 - **Enable Wireless WAN/GPS**
4. Click **OK**.

To disable wireless:

1. Double-click the  icon on the system tray or press <F2>.

The **Wireless Enable/Disable** dialog box appears.

2. Clear the option(s) you want to disable:
 - **Enable Bluetooth**
 - **Enable Wireless LAN/WiMax**
 - **Enable Wireless WAN/GPS**
3. Click **OK**.

 **Note:** Depending on your computer configuration, the WiMax option may not appear.

Ubuntu® Setup

Your Dell computer is preconfigured with the Ubuntu operating system if you requested for Ubuntu while ordering your computer. See the *Ubuntu Quick Start Guide* that shipped with your computer for more operating system specific information.

Microsoft® Windows® Setup

Your Dell computer is preconfigured with Microsoft Windows operating system if you requested for Windows while ordering your computer. To set up Windows for the first time, follow the instructions on the screen. These steps are mandatory and may take up to 15 minutes to complete. The screens will take you through several procedures including accepting license agreements, setting preferences, and setting up an Internet connection.

 **CAUTION:** Do not interrupt the operating system's setup process. Doing so may render your computer unusable.

Connect to the Internet (Optional)

 **NOTE:** ISPs and ISP offerings vary by country.

To connect to the Internet, you need an external modem or network connection and an Internet service provider (ISP).

Setting Up a Wired Internet Connection

If you are using a dial-up connection, connect the telephone line to the external USB modem (optional) and to the telephone wall jack before you set up your Internet connection. If you are using a DSL or cable/satellite modem connection, contact your ISP or cellular telephone service for setup instructions.

Setting Up a Wireless Connection

Before you can use your wireless Internet connection, you need to connect to your wireless router. To set up your connection to a wireless router:

1. Ensure that wireless is enabled on your computer (see “Enable or Disable Wireless” on page 9).
2. Save and close any open files, and exit any open programs.
3. Click the Start button and then click **Connect To**.
4. Follow the instructions on the screen to complete the setup.

Setting Up Your Internet Connection

To set up an Internet connection with a provided ISP desktop shortcut:

1. Save and close any open files, and exit any open programs.

2. Double-click the ISP icon on the Microsoft Windows desktop.
3. Follow the instructions on the screen to complete the setup.

If you do not have an ISP icon on your desktop or if you want to set up an Internet connection with a different ISP, perform the steps in the following section.

 **NOTE:** If you cannot connect to the Internet but have successfully connected in the past, the ISP might have a service outage. Contact your ISP to check the service status, or try connecting again later.

 **NOTE:** Have your ISP information ready. If you do not have an ISP, the **Connect to the Internet** wizard can help you get one.

Windows Vista®

1. Save and close any open files, and exit any open programs.
2. Click **Start**  → **Control Panel**.

Setting Up Your Inspiron™ Laptop

3. Under **Network and Internet**, click **Connect to the Internet**.

The **Connect to the Internet** window appears.

4. Click either **Broadband (PPPoE)** or **Dial-up**, depending on how you want to connect:

- Choose **Broadband** if you will use a DSL, satellite modem, cable TV modem, or Bluetooth® wireless technology connection.
- Choose **Dial-up** if you will use an optional USB dial-up modem or ISDN.

 **NOTE:** If you do not know which type of connection to select, click **Help me choose** or contact your ISP.

5. Follow the instructions on the screen and use the setup information provided by your ISP to complete the setup.

Windows XP

1. Save and close any open files, and exit any open programs.

2. Click **Start** → **Control Panel**.

3. Under **Network and Internet Connections**, select **Setup or Change Your Internet Connection**.

The **Internet Properties** window appears.

4. Click **Setup**.

The **New Connection Wizard** appears.

5. Click **Connect** to the Internet.

6. In the next window, select the appropriate option:

- If you do not have an ISP and want to select one, click **Choose from a list of Internet service providers (ISPs)**.

- If you have already obtained the setup information from your ISP but did not receive a setup CD, click **Set up my connection manually**.
- If you have a CD, click **Use the CD I got from an ISP**.

7. Click **Next**.

If you selected Set up my connection manually, continue to step 6. Otherwise, follow the instructions on the screen to complete the setup.

 **NOTE:** If you do not know which type of connection to select, contact your ISP.

8. Select the appropriate option under **How do you want to connect to the Internet?**, and then click **Next**.
9. Use the setup information provided by your ISP to complete the setup.

Set Up the TV Tuner (Availability Varies by Regions)

You can set up the TV tuner through PowerCinema.

To set up the TV tuner for the first time:

1. Click the PowerCinema icon in **Start** → **All Programs**.
2. Go to **Main Menu** → **Entertainment** → **Live TV** and follow the instructions on the screen.

To re-configure your TV tuner settings:



1. Click the PowerCinema icon in **Start** → **All Programs**.
2. Go to **Main Menu** → **Entertainment** → **Live TV**.
3. Click **Advanced** in the control menu.
4. Select **Settings**.
5. Click **Run Setup Wizard** and follow the instructions on the screen.

Using Your Inspiron™ Laptop

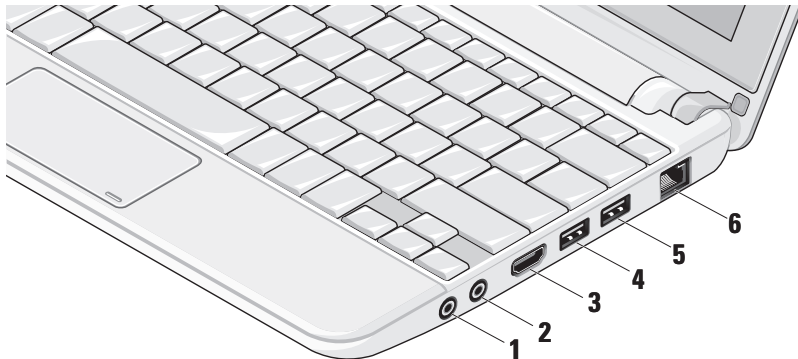

Your Inspiron Mini 10 has indicators and buttons that provide information and enable you to perform common tasks. The connectors on your computer provide the option of attaching additional devices.

Right Side Features



-  **Audio out/Headphone connector** – Connects to a pair of headphones, or sends audio to a powered speaker or sound system.
-  **Audio in/Microphone connector** – Connects to a microphone or input signal for use with audio programs.
-  **HDMI connector** – Connects to a TV for both 5.1 audio and video signals.

 **NOTE:** When used with a monitor, only the video signal is read.

-  **USB 2.0 connector** – Connects to USB devices, such as a mouse, keyboard, printer, external drive, or MP3 player.
-  **Power USB connector** – Connects to USB devices that require more power. This port supports up to 2 A current loading.
-  **Network connector** – Connects your computer to a network or a broadband device if you are using a wired network.

Left Side Features

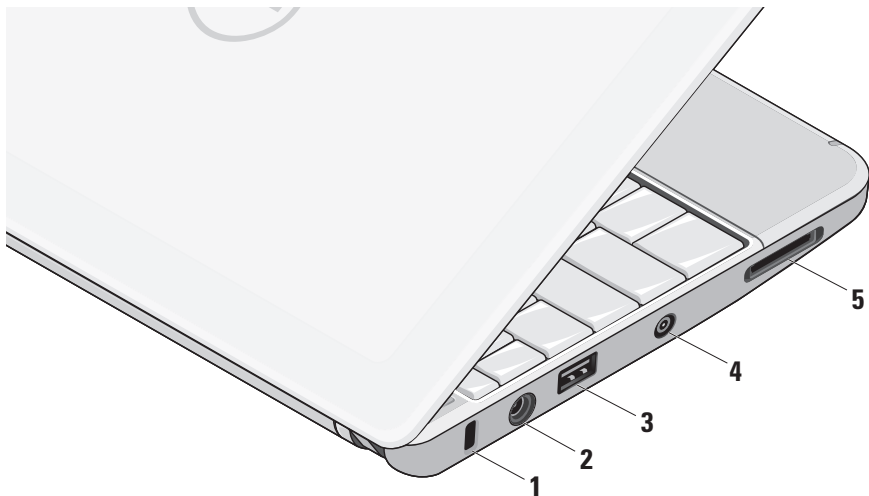

- 1 Security cable slot** – Attaches a commercially available antitheft device to the computer.

 **NOTE:** Before you buy an antitheft device, ensure that it works with the security cable slot on your computer.

- 2**  **AC adapter connector** – Connects to the AC adapter to power on the computer and charge the battery.

- 3**  **USB 2.0 connector** – Connects to USB devices, such as a mouse, keyboard, printer, external drive, or MP3 player.

- 4 Antenna in connector (on supported models)** – Connects to an external antenna, through a MCX connector, to view programs using the TV tuner card (optional). For more information on TV tuner card setup, see “Setting up the TV Tuner (Availability Varies by Regions)” on page 13.

- 5**  **3-in-1 Media Card**

Reader – Provides a fast and convenient way to view and share digital photos, music, videos, and documents stored on the following digital memory cards:

- Secure Digital (SD) memory card
- Secure Digital High Capacity (SDHC) card
- Multimedia Card (MMC)
- Memory Stick
- Memory Stick PRO

Computer Base and Keyboard Features

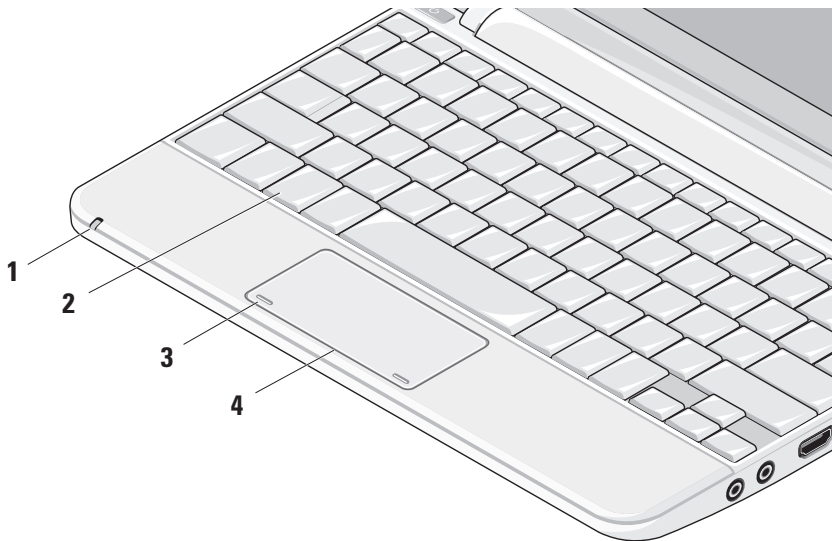

1 Power/Battery indicator light – Turns on steadily or blinks to indicate battery charge status. The light indicates the following states while charging or using the computer with:

an AC adapter

- Solid white: The computer is on and the battery is charging.
- Blinking white: The computer is in a standby mode.
- Off: The computer is off and the battery is adequately charged.

a battery

- Solid white: The computer is on.
- Blinking white: The computer is in standby mode.
- Blinking amber: The battery charge is low. Connect the AC adapter to charge the battery.
- Off: The computer is off.

2 Keyboard – Settings for this keyboard can be personalized by using the system setting utility.

3 Touch pad buttons – Provides left- and right-click functions like those on a mouse.

4 Touch pad – Provides the functionality of a mouse. It supports the **Scroll, Flick, Zoom, Rotate,** and **Desktop** features. For more information, see “Touch Pad Gestures” on page 20.

Touch Pad Gestures

Scroll

Allows you to scroll through content. The scroll feature includes:

Pan – Allows you to move the focus on the selected object when the entire object is not visible.

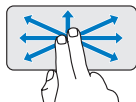

Move two fingers in the desired direction to pan scroll the selected object.

Auto Scroll Vertical – Allows you to scroll up or down on the active window.

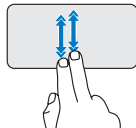

Move two fingers up or down at a fast pace to activate vertical auto scrolling.

Tap on the touch pad to stop auto scrolling.

Auto Scroll Horizontal – Allows you to scroll left or right on the active window.

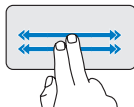

Move two fingers to your left or right at a fast pace to activate auto scrolling horizontally.

Tap on the touch pad to stop auto scrolling.

Flick

Allows you to flip content forward or backward based on the direction of the flick.

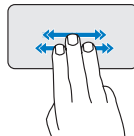

Move three fingers quickly in the desired direction to flip content in the active window.

Zoom

Allows you to increase or decrease the magnification of the screen content. The zoom feature includes:

Pinch – Allows you to zoom in or zoom out by moving two fingers apart or bringing them closer together on the touch pad.

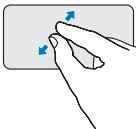

To zoom in: Move two fingers apart to enlarge the view of the active window.

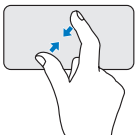

To zoom out: Move two fingers close together to reduce the view of the active window.

Rotate

Allows you to rotate the active content on the screen. The rotate feature includes:

Twist – Allows you to rotate active content in 90 degree increments using two fingers where one finger is anchored and the other rotates.

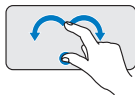

Keeping the thumb in place, move the index finger in an arced direction right or left to rotate the selected item 90 degrees clockwise or counterclockwise.

Desktop

Allows you to minimize all open windows so that the desktop is visible.

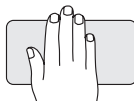

Place your hand on the touch pad in any orientation and briefly hold in place.

Setting the Touch Pad Sensitivity

The palm tracking feature allows you to set the touch pad sensitivity, and is useful in preventing unwanted pointer movement while typing.

To set the touch pad sensitivity:

1. Click **Start**  → **Control Panel** → **Mouse** and select the **Elantech** tab.
2. Click **Options...** and in the **Elan Smart-Pad** window that appears, scroll down and select **PalmTracking**.
3. Drag the **PalmTracking Sensitivity** slider to increase or decrease the touch pad sensitivity.

Display Features

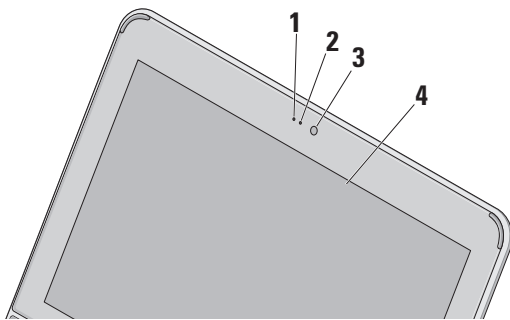

- 1 Microphone** – Provides quality sound for audio chatting and voice recording.
- 2 Camera activity light** – Indicates if the camera is on or off.
- 3 Camera** – Built-in camera for video capture, conferencing, and chat.
- 4 Display** – Your display can vary based on selections you made when purchasing your computer. For more information about displays, see the *Dell Technology Guide*.

Removing and Replacing the Battery

⚠ WARNING: Using an incompatible battery may increase the risk of fire or explosion. This computer should only use a battery purchased from Dell. Do not use batteries from other computers.

⚠ WARNING: Before removing the battery, shut down the computer, and remove external cables (including the AC adapter).

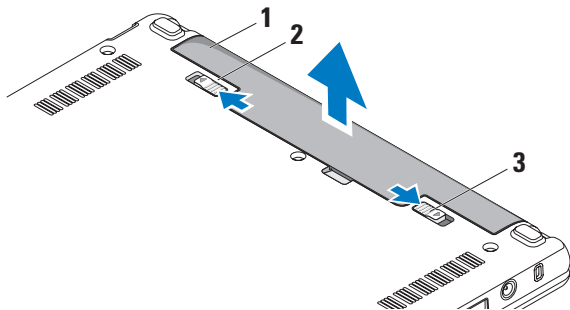

- 1 battery
- 2 battery release latch
- 3 battery lock latch

To remove the battery:

1. Shut down the computer and turn it over.
2. Slide the battery lock latch until it clicks into place.
3. Slide the battery release latch to unlock position.
4. Pull the battery up and out of the battery bay.

To replace the battery, slide it into the bay until it clicks into place. Then slide the battery lock latch to the lock position.

Software Features

 **NOTE:** For more information about the features described in this section, see the *Dell Technology Guide* on your hard drive or on the Dell Support website at support.dell.com.

Productivity and Communication

You can use your computer to create presentations, brochures, greeting cards, fliers, and spreadsheets depending on the applications

installed in your computer. Check your purchase order for software installed on your computer.

After connecting to the Internet, you can access websites, setup an e-mail account, upload and download files, and so on.

Entertainment and Multimedia

You can use your computer to watch videos, play games, listen to music and Internet radio stations.

Customizing the Desktop

You can customize your desktop to change the appearance, resolution, wallpaper, screensaver, and so on.

Windows Vista

1. Right-click an open area of the desktop to access the display properties window.
2. Click **Personalize**, to open the **Personalize appearance and sounds** window and learn more about your customization options.

Windows XP

1. Right-click an open area of the desktop to access the display properties window.
2. Click **Properties**, to open the **Display Properties** window and learn more about your customization options.

Customizing Your Energy Settings

You can use the power options in your operating system to configure the power settings on your computer. Windows provides three default options:

- **Balanced** — This power option offers full performance when you need it and saves power during periods of inactivity.
- **Power saver** — This power option saves power on your computer by reducing system performance to maximize the life of the computer and by reducing the amount of energy consumed by your computer over its lifetime.
- **High performance** — This power option provides the highest level of system

performance on your computer by adapting processor speed to your activity and by maximizing system performance.

Backing Up Your Data

It is recommended that you periodically back up files and folders on your computer. To back up files:

Windows Vista

1. Click **Start**  → **Control Panel** → **System and Maintenance** → **Welcome Center** → **Transfer files and settings**.
2. Click **Back up files** or **Back up computer**.
3. Click **Continue on Your User Account Control** dialog box and follow the instructions in the **Back up Files** wizard.

Windows XP

1. Click **Start** → **All Programs** → **Accessories** → **System Tools** → **Backup**.
2. Follow the instructions in the **Back up Files** wizard.

Solving Problems

 **WARNING:** Only trained service personnel should remove the computer cover. See the *Service Manual* on the Dell Support website at support.dell.com for advanced service instructions.

Network Problems

Wireless Connections

If the wireless network connection is lost

The wireless router is offline or wireless has been disabled on the computer.

- Check your wireless router to ensure it is powered on and connected to your data source (cable modem or network hub).
- Interference may be blocking or interrupting your wireless connection. Try moving the computer closer to your wireless router.

- Re-establish your connection to the wireless router:
 - a. Ensure that wireless is enabled on your computer (see “Enable or Disable Wireless” on page 9).
 - b. Save and close any open files, and exit any open programs.
 - c. Click the Start button and then click **Connect To**.
 - d. Follow the instructions on the screen to complete the setup.

Wired Connections

If the network connection is lost — The cable is loose or damaged.

- Check the cable to ensure it is plugged in and not damaged.

Solving Problems

The link integrity light on the integrated network connector lets you verify that your connection is working and provides information on the status:

- Green — A good connection exists between a 10-Mbps network and the computer.
- Orange — A good connection exists between a 100-Mbps network and the computer.
- Off — The computer is not detecting a physical connection to the network.

 **NOTE:** The link integrity light on the network connector is only for the wired cable connection. The link integrity light does not provide status for wireless connections.

Power Problems

If the power light is off — The computer is either turned off or is not receiving power.

- If the computer is plugged into a power strip, ensure that the power strip is plugged into an electrical outlet and that the power strip is turned on. Also bypass power protection

devices, power strips, and power extension cables to verify that the computer turns on properly.

- Ensure that the electrical outlet is working by testing it with another device, such as a lamp.
- Check the AC adapter cable connections. If the AC adapter has a light, ensure that the light on the AC adapter is on.

If the power light is solid white and the computer is not responding — The display may not be responding. Press the power button until the computer turns off and then turn it back on.

If the power light is blinking white — The computer is in standby mode. Press a key on the keyboard, move the pointer using the touch pad or a connected mouse, or press the power button to resume normal operation.

If the power light is blinking amber — A device might be malfunctioning or the battery charge is low.

- If the computer is receiving electrical power, then a device might be malfunctioning or incorrectly installed.
- If the battery charge is low, connect the computer to the AC adapter.

If you encounter interference that hinders reception on your computer — An unwanted signal is creating interference by interrupting or blocking other signals. Some possible causes of interference are:

- Power, keyboard, and mouse extension cables.
- Too many devices connected to a power strip.
- Multiple power strips connected to the same electrical outlet.

Memory Problems

If you receive an insufficient memory message

- Save and close any open files and exit any open programs you are not using to see if that resolves the problem.
- See the software documentation for minimum memory requirements. If necessary, install additional memory (See the *Service Manual* on the Dell Support website at support.dell.com).

If you experience other memory problems —

- Check if the memory module is compatible with your computer. Your computer supports DDR2 memory. For more information about the type of memory supported by your computer, see “Specifications” on page 52.
- Reseat the memory modules (see the *Service Manual* on the Dell Support website at support.dell.com).
- Run the Dell Diagnostics (see “Dell Diagnostics” on page 35).

Lockups and Software Problems

If the computer does not start up — Ensure that the power cable is firmly connected to the computer and to the electrical outlet.

If a program stops responding — End the program:

1. Press <Ctrl><Shift><Esc> simultaneously.
2. Click **Applications**.
3. Click the program that is no longer responding
4. Click **End Task**.

If a program crashes repeatedly — Check the software documentation. If necessary, uninstall and then reinstall the program.

 **NOTE:** Software usually includes installation instructions in its documentation or on the media (CD or DVD).

 **NOTE:** Your computer may or may not have an optical drive. Use an external optical drive or any external storage device for the procedures that involve media.

If the computer stops responding or a solid blue screen appears —

 **CAUTION:** You might lose data if you are unable to perform an operating system shutdown.

If you are unable to get a response by pressing a key on your keyboard or moving your mouse, press the power button for at least 8 to 10 seconds until the computer turns off and then restart your computer.

If a program is designed for an earlier Microsoft® Windows® operating system —

Run the Program Compatibility Wizard. The Program Compatibility Wizard configures a program so that it runs in an environment similar to non-Windows Vista/non-XP operating system environments.

Windows Vista

1. Click **Start**  → **Control Panel** → **Programs** → **Use an older program with this version of Windows**. In the welcome screen, click **Next**.
2. Follow the instructions on the screen.

Windows XP

1. Click **Start** → **All Programs** → **Accessories** → **Program Compatibility Wizard**.
2. In the welcome screen, click **Next**.
3. Follow the instructions on the screen.

If you have other software problems —

- Back up your files immediately.
- Use a virus-scanning program to check the hard drive or CDs.
- Save and close any open files or programs and shut down your computer through the **Start** menu.

- Check the software documentation or contact the software manufacturer for troubleshooting information:
 - Ensure that the program is compatible with the operating system installed on your computer.
 - Ensure that your computer meets the minimum hardware requirements needed to run the software. See the software documentation for information.
 - Ensure that the program is installed and configured properly.
 - Verify that the device drivers do not conflict with the program.
 - If necessary, uninstall and then reinstall the program, Dell Support Center.
 - Write down any error message that is displayed to help in troubleshooting when Contacting Dell.

Using Support Tools

 **NOTE:** The instructions in this section are for computers with Windows Vista operating system installed.

Dell Support Center

The **Dell Support Center** helps you find the service, support, and system-specific information you need. For more information about **Dell Support Center** and available support tools, click the **Services** tab at support.dell.com.



Click the  icon in the taskbar to run the application. The home page provides links to access:

- Self Help (Troubleshooting, Security, System Performance, Network/Internet, Backup/Recovery, and Windows operating system)
- Alerts (technical support alerts relevant to your computer)

- Assistance from Dell (Technical Support with DellConnect™, Customer Service, Training and Tutorials, How-To Help with Dell on Call, and Online Scan with PCCheckUp)
- About Your System (System Documentation, Warranty Information, System Information, Upgrades & Accessories)

The top of the **Dell Support Center** home page displays your computer's model number along with its service tag and express service code.

For more information about the **Dell Support Center**, see the *Dell Technology Guide* on your hard drive or on the Dell Support website at support.dell.com.

System Messages

If your computer has an issue or error, it may display a System Message that will help you identify the cause and action needed to resolve the issue.

 **NOTE:** If the message you received is not listed in the following examples, see the documentation for either the operating system or the program that was running when the message appeared. Alternatively see the *Dell Technology Guide* on your hard drive or the Dell Support website at support.dell.com.

Alert! Previous attempts at booting this system have failed at checkpoint [nnnn]. For help in resolving this problem, please note this checkpoint and contact Dell Technical Support — The computer failed to complete the boot routine three consecutive times for the same error (see “Contacting Dell” on page 49 for assistance).

CMOS checksum error — Possible motherboard failure or RTC battery low. Replace the battery. (See the *Dell Technology Guide* on your hard disk or the Dell Support website at support.dell.com or see “Contacting Dell” on page 49 for assistance).

Hard-disk (HDD) drive failure — Possible hard disk drive failure during POST (see “Contacting Dell” on page 49 for assistance).

Hard-disk (HDD) drive read failure — Possible hard disk drive failure during HDD boot test (see “Contacting Dell” on page 49 for assistance).

Keyboard failure — Keyboard failure or loose cable.

No boot device available — No bootable partition on hard disk drive, the hard disk drive connector is loose, or no bootable device exists.

- If the hard drive is your boot device, ensure that the connector is connected and that the drive is installed properly and partitioned as a boot device.

Using Support Tools

- Enter system setup and ensure that the boot sequence information is correct (see the *Dell Technology Guide* on your hard disk or the Dell Support website at support.dell.com).

No timer tick interrupt — A chip on the system board might be malfunctioning or motherboard failure (see “Contacting Dell” on page 49 for assistance).

USB over current error — Disconnect the USB device. Your USB device needs more power for it to function properly. Use an external power source to connect the USB device, or if your device has two USB cables, connect both of them.

NOTICE - Hard Drive SELF MONITORING SYSTEM has reported that a parameter has exceeded its normal operating range. Dell recommends that you back up your data regularly. A parameter out of range may or may not indicate a potential hard drive problem — S.M.A.R.T error, possible hard disk drive failure. This feature can be enabled or disabled in the

BIOS setup (see “Contacting Dell” on page 49 for assistance).

Hardware Troubleshooter

If a device is either not detected during the operating system setup or is detected but incorrectly configured, you can use the **Hardware Troubleshooter** to resolve the incompatibility.

To start the Hardware Troubleshooter:

1. Click the Start button and then click **Help and Support**.
2. Type `hardware troubleshooter` in the search field and press <Enter> to start the search.
3. In the search results, select the option that best describes the problem and follow the remaining troubleshooting steps.

Dell Diagnostics

If you experience a problem with your computer, perform the checks in “Lockups and Software Problems” on page 30 and run the Dell Diagnostics before you contact Dell (see “Contacting Dell” on page 49) for technical assistance.

It is recommended that you print these procedures before you begin.

 **NOTE:** Dell Diagnostics works only on Dell computers.

 **NOTE:** The *Drivers and Utilities* media is optional and may not ship with your computer.

To review your computer’s configuration information, and ensure that the device that you want to test displays in the system setup program and is active. See the System Setup section in the *Dell Technology Guide*.

Start the Dell Diagnostics from your hard drive or from the *Drivers and Utilities* media.

Starting Dell Diagnostics From Your Hard Drive

The Dell Diagnostics is located on a hidden diagnostic utility partition on your hard drive.

 **NOTE:** If your computer cannot display a screen image, see “Contacting Dell” on page 49.

1. Ensure that the computer is connected to an electrical outlet that is known to be working properly.
2. Turn on (or restart) your computer.
3. When the DELL™ logo appears, press <F12> immediately. Select **Diagnostics** from the boot menu and press <Enter>.

 **NOTE:** If you wait too long and the operating system logo appears, continue to wait until you see the Microsoft® Windows® desktop; then, shut down your computer and try again.

 **NOTE:** If you see a message stating that no diagnostics utility partition has been found, run the Dell Diagnostics from the *Drivers and Utilities* media.

Using Support Tools

4. Press any key to start the Dell Diagnostics from the diagnostics utility partition on your hard drive.

Starting Dell Diagnostics From the Drivers and Utilities Media

 **NOTE:** Your computer may or may not have an optical drive. Use an external optical drive or any external storage device for the procedures that involves media.

1. Insert the *Drivers and Utilities* media.
2. Shut down and restart the computer. When the DELL logo appears, press <F2> immediately.

 **NOTE:** If you wait too long and the operating system logo appears, continue to wait until you see the Microsoft® Windows® desktop; then, shut down your computer and try again.

 **NOTE:** The next steps change the boot sequence for one time only. On the next start-up, the computer boots according to the devices specified in the system setup program.

3. When the boot device list appears, highlight **CD/DVD/CD-RW** and press <Enter>.
4. Select the **Boot from CD-ROM** option from the menu that appears and press <Enter>.
5. Type 1 to start the CD menu and press <Enter> to proceed.
6. Select **Run the 32 Bit Dell Diagnostics** from the numbered list. If multiple versions are listed, select the version appropriate for your computer.
7. When the Dell Diagnostics **Main Menu** appears, select the test you want to run.

Restoring Your Operating System

You can restore your operating system in the following ways:

- System Restore returns your computer to an earlier operating state without affecting data files. Use System Restore as the first solution for restoring your operating system and preserving data files.
- Dell Factory Image Restore returns your hard drive to the operating state it was in when you purchased the computer. This procedure permanently deletes all data on the hard drive and removes any programs installed after you received the computer. Use Dell Factory Image Restore only if System Restore did not resolve your operating system problem.
- If you received an Operating System disc with your computer, you can use it to restore your operating system. However, using the

Operating System disc also deletes all data on the hard drive. Use the disc only if System Restore did not resolve your operating system problem.

System Restore

The Windows operating systems provide a System Restore option which allows you to return your computer to an earlier operating state (without affecting data files) if changes to the hardware, software, or other system settings have left the computer in an undesirable operating state. Any changes that System Restore makes to your computer are completely reversible.





CAUTION: Make regular backups of your data files. System Restore does not monitor your data files or recover them.

Restoring Your Operating System

 **NOTE:** The procedures in this document were written for the Windows default view, so they may not apply if you set your Dell™ computer to the Windows Classic view.

Starting System Restore in Windows Vista

1. Click **Start** .
 2. In the **Start Search** box, type `System Restore` and press <Enter>.
-  **NOTE:** The **User Account Control** window may appear. If you are an administrator on the computer, click **Continue**; otherwise, contact your administrator to continue the desired action.
3. Click **Next** and follow the remaining prompts on the screen.

In the event that System Restore did not resolve the issue, you may undo the last system restore.

Starting System Restore in Windows XP

1. Click **Start** → **All Programs** → **Accessories** → **System Tools** → **System Restore**.
2. In the welcome screen, click **Next**.
3. Follow the instructions on the screen.

Undoing the Last System Restore in Windows Vista

 **NOTE:** Before you undo the last system restore, save and close all open files and exit any open programs. Do not alter, open, or delete any files or programs until the system restoration is complete.

1. Click **Start** .
2. In the **Start Search** box, type `System Restore` and press <Enter>.
3. Click **Undo my last restoration** and click **Next**.

Undoing the Last System Restore in Windows XP

 **NOTE:** Before you undo the last system restore, save and close all open files and exit any open programs. Do not alter, open, or delete any files or programs until the system restoration is complete.

1. Click **Start**→ **All Programs**→ **Accessories**→ **System Tools**→ **System Restore**.
2. In the welcome screen, click **Undo my last restoration** and then click **Next**.
3. Follow the instructions on the screen.

Using Dell™ PC Restore in Windows XP

 **CAUTION:** Using Dell PC Restore permanently deletes all data on the hard drive and removes any programs or drivers installed after you received your computer. If possible, back up the data before using these options. Use PC Restore only if System Restore did not resolve your operating system problem.

 **NOTE:** Dell PC Restore by Symantec and Dell Factory Image Restore may not be available in certain countries or on certain computers.

Use Dell PC Restore only as the last method to restore your operating system. These options restore your hard drive to the operating state it was in when you purchased the computer. Any programs or files added since you received your computer—including data files—are permanently deleted from the hard drive.

Restoring Your Operating System

Data files include documents, spreadsheets, e-mail messages, digital photos, music files, and so on. If possible, back up all data before using PC Restore.

Using PC Restore:

1. Turn on the computer.

During the boot process, a blue bar with **www.dell.com** appears at the top of the screen.

2. Immediately upon seeing the blue bar, press <Ctrl><F11>. If you do not press <Ctrl><F11> in time, let the computer finish starting, and then restart the computer again.

 **CAUTION: If you do not want to proceed with PC Restore, click Reboot.**

3. Click **Restore** and click **Confirm**.

The restore process takes approximately 6 to 10 minutes to complete.

4. When prompted, click **Finish** to reboot the computer.

 **NOTE:** Do not manually shut down the computer. Click **Finish** and let the computer completely reboot.

5. When prompted, click **Yes**.

The computer restarts. Because the computer is restored to its original operating state, the screens that appear, such as the End User License Agreement, are the same ones that appeared the first time the computer was turned on.

6. Click **Next**.

The System Restore screen appears and the computer restarts.

After the computer restarts, click **OK**.

Dell Factory Image Restore

 **CAUTION:** Using Dell Factory Image Restore permanently deletes all data on the hard drive and removes any programs or drivers installed after you received your computer. If possible, back up the data before using this option. Use Dell Factory Image Restore only if System Restore did not resolve your operating system problem.

 **NOTE:** Dell Factory Image Restore may not be available in certain countries or on certain computers.

Use Dell Factory Image Restore only as the last method to restore your operating system. These options restore your hard drive to the operating state it was in when you purchased the computer. Any programs or files added since you received your computer—including data files—are permanently deleted from the hard drive. Data files include documents,

spreadsheets, e-mail messages, digital photos, music files, and so on. If possible, back up all data before using Factory Image Restore.

Dell Factory Image Restore

1. Turn on the computer. When the Dell logo appears, press <F8> several times to access the **Vista Advanced Boot Options** Window.
2. Select **Repair Your Computer**.
3. The **System Recovery Options** window appears.
4. Select a keyboard layout and click **Next**.
5. To access the recovery options, log on as a local user. To access the command prompt, type `administrator` in the **User name** field, then click **OK**.
6. Click **Dell Factory Image Restore**. The **Dell Factory Image Restore** welcome screen appears.

 **NOTE:** Depending upon your configuration, you may need to select **Dell Factory Tools**, then **Dell Factory Image Restore**.

7. Click **Next**. The **Confirm Data Deletion** screen appears.

 **NOTE:** If you do not want to proceed with Factory Image Restore, click **Cancel**.

8. Select the checkbox to confirm that you want to continue reformatting the hard drive and restoring the system software to the factory condition, then click **Next**.

The restore process begins and may take five or more minutes to complete. A message appears when the operating system and factory-installed applications have been restored to factory condition.

9. Click **Finish** to reboot the system.

Operating System Reinstallation

Before You Begin

If you are considering reinstalling the Windows operating system to correct a problem with a newly installed driver, first try using Windows Device Driver Rollback. If Device Driver Rollback does not resolve the problem, then use System Restore to return your operating system to the operating state it was in before you installed the new device driver. See “System Restore” on page 37.

 **CAUTION:** Before performing the installation, back up all data files on your primary hard drive. For conventional hard drive configurations, the primary hard drive is the first drive detected by the computer.

To reinstall Windows, you need the following items:

- *Dell Operating System* media
- *Dell Drivers and Utilities* media

 **NOTE:** The *Dell Drivers and Utilities* media contains drivers that were installed during the assembly of the computer. Use the Dell Drivers and Utilities media to load any required drivers. Depending on the region from which you ordered your computer, or whether you requested the media, the *Dell Drivers and Utilities* media and *Operating System* media may not ship with your computer.

Reinstalling Windows

The reinstallation process can take 1 to 2 hours to complete. After you reinstall the operating system, you must also reinstall the device drivers, virus protection program, and other software.

 **NOTE:** Your computer may or may not have an optical drive. Use an external optical drive or any external storage device for the procedures that involve media.

1. Save and close any open files and exit any open programs.

2. Insert the *Operating System* disc.
3. Click **Exit** if the **Install Windows** message appears.
4. Restart the computer.
5. When the DELL logo appears, press <F2> immediately.

 **NOTE:** If you wait too long and the operating system logo appears, continue to wait until you see the Microsoft® Windows® desktop; then, shut down your computer and try again.

 **NOTE:** The next steps change the boot sequence for one time only. On the next start-up, the computer boots according to the devices specified in the system setup program.

6. When the boot device list appears, highlight **CD/DVD/CD-RW Drive** and press <Enter>.
7. Press any key to **Boot from CD-ROM**. Follow the instructions on the screen to complete the installation.

Getting Help

If you experience a problem with your computer, you can complete the following steps to diagnose and troubleshoot the problem:

1. See “Solving Problems” on page 27 for information and procedures that pertain to the problem your computer is experiencing.
2. See “Dell Diagnostics” on page 35 for procedures on how to run Dell Diagnostics.
3. Fill out the “Diagnostic Checklist” on page 48.
4. Use Dell’s extensive suite of online services available at Dell Support (support.dell.com) for help with installation and troubleshooting procedures. See “Online Services” on page 45 for a more extensive list of Dell Support online.
5. If the preceding steps have not resolved the problem, see “Before You Call” on page 48 and then “Contacting Dell” on page 49.

 **NOTE:** Call Dell Support from a telephone near or at the computer so that the support staff can assist you with any necessary procedures.

 **NOTE:** Dell’s Express Service Code system may not be available in all countries.

When prompted by Dell’s automated telephone system, enter your Express Service Code to route the call directly to the proper support personnel. If you do not have an Express Service Code, open the **Dell Accessories** folder, double-click the **Express Service Code** icon, and follow the directions.

 **NOTE:** Some of the services mentioned below are not always available in all locations outside the continental U.S. Call your local Dell representative for information on availability.

Technical Support and Customer Service

Dell's support service is available to answer your questions about Dell hardware. Our support staff use computer-based diagnostics to provide fast, accurate answers.

To contact Dell's support service, see "Before You Call" on page 48 and then see the contact information for your region or go to **support.dell.com**.

DellConnect™

DellConnect is a simple online access tool that allows a Dell service and support associate to access your computer through a broadband connection, diagnose your problem, and repair it all under your supervision. For more information, go to **www.dell.com/DellConnect**.

Online Services

You can learn about Dell products and services on the following websites:

- **www.dell.com**
- **www.dell.com/ap** (Asian/Pacific countries only)
- **www.dell.com/jp** (Japan only)
- **www.euro.dell.com** (Europe only)
- **www.dell.com/la** (Latin American and Caribbean countries)
- **www.dell.ca** (Canada only)

You can access Dell Support through the following websites and e-mail addresses:

Dell Support websites

- **support.dell.com**
- **support.jp.dell.com** (Japan only)
- **support.euro.dell.com** (Europe only)

Getting Help

Dell Support e-mail addresses

- **mobile_support@us.dell.com**
- **support@us.dell.com**
- **la-techsupport@dell.com** (Latin America and Caribbean countries only)
- **apsupport@dell.com** (Asian/Pacific countries only)

Dell Marketing and Sales e-mail addresses

- **apmarketing@dell.com** (Asian/Pacific countries only)
- **sales_canada@dell.com** (Canada only)

Anonymous file transfer protocol (FTP)

- **ftp.dell.com**

Log in as user: `anonymous`, and use your e-mail address as your password.

Automated Order-Status Service

To check on the status of any Dell products that you have ordered, you can go to **support.dell.com**, or you can call the automated

order-status service. A recording prompts you for the information needed to locate and report on your order. For the telephone number to call your region, see “Contacting Dell” on page 49 for problems with your order.

If you have a problem with your order, such as missing parts, wrong parts, or incorrect billing, contact Dell for customer assistance. Have your invoice or packing slip handy when you call. For the telephone number to call for your region, see “Contacting Dell” on page 49.

Product Information

If you need information about additional products available from Dell, or if you would like to place an order, visit the Dell website at **www.dell.com**. For the telephone number to call for your region or to speak to a sales specialist, see “Contacting Dell” on page 49.

Returning Items for Repair Under Warranty or for Credit

Prepare all items being returned, whether for repair or credit, as follows:

1. Call Dell to obtain a Return Material Authorization Number, and write it clearly and prominently on the outside of the box.

 **NOTE:** For the telephone number to call for your region, see “Contacting Dell” on page 49.

2. Include a copy of the invoice and a letter describing the reason for the return.
3. Include a copy of the Diagnostics Checklist (see “Dell Diagnostics” on page 35), indicating the tests that you have run and any error messages reported by the Dell Diagnostics (see “Dell Diagnostics” on page 35).

4. Include any accessories that belong with the item(s) being returned (power cables, software, guides, and so on) if the return is for credit.
5. Pack the equipment to be returned in the original (or equivalent) packing materials.

 **NOTE:** You are responsible for paying shipping expenses. You are also responsible for insuring any product returned, and you assume the risk of loss during shipment to Dell. Collect On Delivery (C.O.D.) packages are not accepted.

 **NOTE:** Returns that are missing any of the preceding requirements will be refused at Dell’s receiving dock and returned to you.

Before You Call

 **NOTE:** Have your Express Service Code ready when you call. The code helps Dell's automated-support telephone system direct your call more efficiently. You may also be asked for your Service Tag (located on the back or bottom of your computer).

Remember to fill out the following Diagnostic Checklist. If possible, turn on your computer before you call Dell for assistance and call from a telephone at or near the computer. You may be asked to type some commands at the keyboard, relay detailed information during operations, or try other troubleshooting steps possible only at the computer itself. Ensure that the computer documentation is available.

Diagnostic Checklist

- Name:
- Date:
- Address:
- Phone number:
- Service Tag (bar code on the back or bottom of the computer):
- Express Service Code:
- Return Material Authorization Number (if provided by Dell support technician):
- Operating system and version:
- Devices:
- Expansion cards:
- Are you connected to a network? Yes /No
- Network, version, and network adapter:
- Programs and versions:

See your operating system documentation to determine the contents of the computer's start-up files. If the computer is connected to a printer, print each file. Otherwise, record the contents of each file before calling Dell.

- Error message, beep code, or diagnostic code:
- Description of problem and troubleshooting procedures you performed:

Contacting Dell

For customers in the United States, call 800-WWW-DELL (800-999-3355).

 **NOTE:** If you do not have an active Internet connection, you can find contact information on your purchase invoice, packing slip, bill, or Dell product catalog.

Dell provides several online and telephone-based support and service options. Availability varies by country and product, and some services may not be available in your area.

To contact Dell for sales, technical support, or customer service issues:

1. Visit **support.dell.com**.
2. Verify your country or region in the **Choose A Country/Region** drop-down menu at the bottom of the page.
3. Click **Contact Us** on the left side of the page.
4. Select the appropriate service or support link based on your need.
5. Choose the method of contacting Dell that is convenient for you.

Finding More Information and Resources

If you need to:

reinstall your operating system.

run a diagnostic program for your computer, reinstall desktop system software, or update drivers for your computer, and readme files.

learn more about your operating system, maintaining peripherals, RAID, Internet, Bluetooth®, networking, and e-mail.

upgrade your computer with new or additional memory, or a new hard drive.

reinstall or replace a worn or defective part.

See:

the Operating System media.

the *Drivers and Utilities* media.



NOTE: Drivers and documentation updates can be found on the Dell™ Support website at **support.dell.com**.

the *Dell Technology Guide* installed on your hard drive.

the *Service Manual* on the Dell Support website at **support.dell.com**



NOTE: In some countries, opening and replacing parts of your computer may void your warranty. Check your warranty and return policies before working inside your computer.

If you need to:

find safety best practices information for your computer

review Warranty information, Terms and Conditions (U.S. only), Safety instructions, Regulatory information, Ergonomics information, and End User License Agreement.

find your Service tag/Express Service Code— You must use the service tag to identify your computer on **support.dell.com** or to contact technical support.

find drivers and downloads.

access technical support and product help.

check on your order status for new purchases.

find solutions and answers to common questions.

locate information for last-minute updates about technical changes to your computer or advanced technical-reference material for technicians or experienced users.

See:

the safety and regulatory documents that shipped with your computer and also see the Regulatory Compliance Homepage at **www.dell.com/regulatory_compliance**.

the back or bottom of your computer.

the Dell™ Support website at **support.dell.com**.

Specifications

System Model

Dell™ Inspiron™ Mini 10

This section provides information that you may need when setting up, updating drivers for, and upgrading your computer.

 **NOTE:** Offerings may vary by region. For more information regarding the configuration of your computer, click **Start** → **Help and Support** and select the option to view information about your computer.

Processor

Type	Intel® Atom™
L2 Cache	512 MB
External bus frequency	533-MT/s (133 MHz)

Memory

Connectors	none
Capacities	1 GB and 2 GB
Memory type	DDR2-800 (DDR bus runs at DDR2-533 bandwidth only)
Memory configuration possible	1 GB, 2 GB

Computer Information

System Chipset	Intel LPIA (Low Power Intel Architecture) Poulsbo US15W
Data bus width	64 bits
DRAM bus width	single channel 64-bit buses
Processor address bus width	32 bits
Flash EEPROM	1 MB
Internal Storage	2.5 inches HDD SATA, 2.5 inches HDD SSD
TV tuner	internal TV tuner module

Communications

Modem type	External V.92 56K USB Modem
Modem interface	Universal Serial Bus (USB)
Network adapter	10/100 Ethernet LAN on system board
Wireless	WLAN, WiMax, WWAN/GPS (3G Mini-Card that can activate 3G, or GPS, or both), Bluetooth® wireless technology

Specifications

Video		Audio	
video controller	Intel LPIA Poulsbo	Internal Interface	Intel High Definition Audio
video memory	8 MB system memory (shared)	External Interface	integrated analog microphone, integrated analog speaker
LCD interface	LVDS	Speaker	two 1.0 watt speakers
Audio		Internal speaker amplifier	1.0 watt per channel
Audio type	2 channel High Definition Audio with optional SRS Premium Sound™	Volume controls	software program controlled
Audio controller	ALC269		
Stereo conversion	24-bit (analog-to-digital and digital-to-analog)		

Connectors

Audio	microphone connector, one stereo headphone/ speakers connector, digital MIC with camera module (optional)
Mini-Card	two full size Mini Card slots and one half size Mini Card slot, the half size slot supports dual interface and the full size slots support USB only
Network adapter	RJ45 port
USB	three 4-pin USB 2.0-compliant connectors
Video	19-pin type A HDMI connector

Display

Type	10.1 inch WSVGA AG 10.1 inch HD AG
<i>Dimensions:</i>	
Height	222.72 mm (8.76 inches) WSVGA AG 222.73 mm (8.76 inches) HD AG
Width	125.28 mm (4.93 inches) WSVGA AG 125.22 mm (4.92 inches) HD AG
Diagonal	255.52 mm (10.06 inches)
Maximum resolution	1024 x 600 WSVGA AG 1366 x 768 HD AG
Refresh rate	60 Hz

Specifications

Display

Operating angle	0° (closed) to 135°
Luminance	180 min 200 typ. cd/m ² (5 point avg) WSVGA AG 230 min 250 typ. cd/m ² (5 point avg) HD AG

Viewing Angles:

Horizontal	±40° (CR≥10) typ.WSVGA AG ±60° (CR≥10) typ.HD AG
Vertical	+10° to +30° (CR≥10) typ. WSVGA AG +50° (CR≥10) typ. HD AG

Display

Pixel pitch	0.2175 x 0.2175 mm WSVGA AG 0.16305 x 0.16305 mm HD AG
Controls	brightness can be controlled through keyboard shortcuts (see the <i>Dell Technology Guide</i> for more information).

Keyboard

Number of keys	82 (U.S. and Canada); 83 (Europe); 86 (Japan); 82 (Korea)
----------------	---

Camera

Pixel	1.3 megapixel
Video resolution	320 x 240 ~1280 x 1024 (640 x 480 at 30 fps)
Diagonal viewing angle	66°

Touch pad

X/Y position resolution (graphics table mode)	240 cpi
<i>Size:</i>	
Width	78.5 mm (3.09 inches) sensor-active area
Height	38 mm (1.49 inches) rectangle

AC Adapter

Input voltage	100–240 VAC
Input current (maximum)	1.0 A
Input frequency	50–60 Hz
Output power	30 W
Output current	1.58 A (maximum)
Rated output voltage	19.0 VDC
<i>Dimensions:</i>	
30 W (APD):	
Height	59.2 mm (2.33 inches)
Width	34.0 mm (1.34 inches)
Depth	85.0 mm (3.35 inches)
Weight (with cables)	0.15 kg (0.33 lb)

Specifications

AC Adapter

30 W (PI):

Height	70.0 mm (2.76 inches)
Width	36.0 mm (1.42 inches)
Depth	78.0 mm (3.07 inches)
Weight (with cables)	0.156 kg (0.34 lb)

Physical

Height	25.3 mm to 28.0 mm (0.99 inches to 1.10 inches)
Width	261 mm (10.27 inches)
Depth	182.5 mm (7.18 inches)
Weight (with 3-cell battery):	
Configurable to less than	1.30 kg (2.86 lb)

Computer Environment

Temperature range:

Operating	0° to 35°C (32° to 95°F)
Storage	-20° to 65°C (-4° to 149°F)

Relative humidity (maximum):

Operating	10% to 90% (non condensing)
Storage	5% to 90% (non condensing)

*Maximum vibration (using a random-vibration
spectrum that simulates user environment):*

Operating	0.66 GRMS
Non-Operating	1.3 GRMS

Computer Environment

Maximum shock (for operating – measured with Dell Diagnostics running on the hard drive and a 2 ms half-sine pulse; for non-operating – measured with hard drive in head-parked position and a 2 ms half-sine pulse):

Operating 110 GRMS

Non- Operating 160 GRMS

Index

A

AC adapter

size and weight **57, 58**

airflow, allowing **5**

B

backups

creating **26**

C

calling Dell **48**

chipset **53**

computer, setting up **5**

connect(ing)

to the Internet **10**

conserving energy **26**

Contacting Dell online **49**

customer service **45**

customizing

your energy settings **26**

D

damage, avoiding **5**

data, backing up **26**

DellConnect **45**

Dell Factory Image Restore **37**

Dell Support Center **32**

Dell support website **51**

Dell Technology Guide

for further information **50**

Diagnostic Checklist **48**

drivers and downloads **51**

E

e-mail addresses

for technical support **46**

energy

conserving **26**

expansion bus **53**

F

finding more information **50**

FTP login, anonymous **46**

H

hardware problems

diagnosing **34**

Hardware Troubleshooter **34**

help

getting assistance and support **44**

I

Internet connection **10**

ISP

Internet Service Provider **10**

M

memory problems

solving **29**

memory support **52**

N

network connection

fixing **27**

network speed

testing **27**

O

order status **46**

P

- power problems, solving **28**
- power strips, using **6**
- problems, solving **27**
- processor **52**
- products
 - information and purchasing **46**

R

- reinstalling Windows **37**
- resources, finding more **50**
- restoring factory image **41**

S

- setup, before you begin **5**
- shipping products
 - for return or repair **47**
- software features **25**

- software problems **30**
- solving problems **27**
- specifications **52**
- support e-mail addresses **46**
- support sites
 - worldwide **45**
- System Messages **33**
- system reinstall options **37**
- System Restore **37**

T

- technical support **45**

V

- ventilation, ensuring **5**

W

- warranty returns **47**
- Windows, reinstalling **37**

Windows Vista®

- Program Compatibility Wizard **30**

- reinstalling **43**

- setup **10**

Windows XP **31**

- wired network

- network cable, connecting **7**

- wireless network connection **27**

Printed in China.

Printed on recycled paper.

www.dell.com | support.dell.com



OR891KA01

Free Manuals Download Website

<http://myh66.com>

<http://usermanuals.us>

<http://www.somanuals.com>

<http://www.4manuals.cc>

<http://www.manual-lib.com>

<http://www.404manual.com>

<http://www.luxmanual.com>

<http://aubethermostatmanual.com>

Golf course search by state

<http://golfingnear.com>

Email search by domain

<http://emailbydomain.com>

Auto manuals search

<http://auto.somanuals.com>

TV manuals search

<http://tv.somanuals.com>