

studio

SETUP GUIDE



studio

SETUP GUIDE

Model PP24L

Notes, Notices, and Cautions



NOTE: A NOTE indicates important information that helps you make better use of your computer.



NOTICE: A NOTICE indicates either potential damage to hardware or loss of data and tells you how to avoid the problem.



CAUTION: A CAUTION indicates a potential for property damage, personal injury, or death.

If you purchased a Dell™ n Series computer, any references in this document to Microsoft® Windows® operating systems are not applicable.

Information in this document is subject to change without notice.

© 2008 Dell Inc. All rights reserved.

Reproduction of these materials in any manner whatsoever without the written permission of Dell Inc. is strictly forbidden.

Trademarks used in this text: *Dell*, the *DELL* logo, *MediaDirect*, *Wi-Fi Catcher*, *YOURS IS HERE*, and *DellConnect* are trademarks of Dell Inc.; *Intel*, *Pentium*, and *Celeron* are registered trademarks and *Core* is a trademark of Intel Corporation; *Microsoft*, *Windows*, and *Windows Vista* are either trademarks or registered trademarks of Microsoft Corporation in the United States and/or other countries.; *Blu-ray Disc* is a trademark of the Blu-ray Disc Association; *Bluetooth* is a registered trademark owned by Bluetooth SIG, Inc. and is used by Dell under license.

Other trademarks and trade names may be used in this document to refer to either the entities claiming the marks and names or their products. Dell Inc. disclaims any proprietary interest in trademarks and trade names other than its own.

August 2008

P/N P479C

Rev. A00

Contents

Setting Up Your Studio Laptop	7	Display Features	26
Before Setting Up Your Studio Laptop	7	Media Controls.....	27
Connecting the AC Adapter	8	Removing and Replacing the Battery	28
Connecting the Network Cable (optional)	9	Using the Optical Disc Drive.....	29
Turning on Your Studio laptop.....	9	Software Features	29
Using the Wireless Switch	10	Solving Problems	32
Windows Vista® Setup	10	Network Problems.....	32
Connecting to the Internet (Optional)	11	Power Problems.....	33
Using Your Studio Laptop	14	Memory Problems	34
Device Status Lights	14	Lockups and Software Problems	35
Right Side Features	16	Dell Support Center	37
Left Side Features	20	Using Support Tools	37
Computer Base and Keyboard Features	23	System Messages	38
		Hardware Troubleshooter.....	39
		Dell Diagnostics	40

Restoring Your Operating System	42	Finding More Information	
System Restore	42	and Resources	54
Dell Factory Image Restore	43	Basic Specifications	56
Operating System Reinstallation	45	Appendix	68
Getting Help	47	Macrovision Product Notice	68
Technical Support and Customer		Index	69
Service	48		
DellConnect™	48		
Online Services	48		
AutoTech Service	49		
Product Information	50		
Returning Items for Repair			
Under Warranty or for Credit	50		
Before You Call	51		
Contacting Dell	52		

Setting Up Your Studio Laptop

This section provides information about setting up your Studio 1435 laptop and connecting peripherals.

Before Setting Up Your Studio Laptop

When positioning your computer, ensure that you allow easy access to a power source, adequate ventilation, and a level surface to place your computer.

Restricting airflow around your Studio computer may cause it to overheat. To prevent overheating ensure that you leave at least 10.2 cm (4 in) at the back of the computer and a minimum of 5.1 cm (2 in) on all other sides. You should never put your computer in an enclosed space, such as a cabinet or drawer when it is powered on.



CAUTION: Do not block, push objects into, or allow dust to accumulate in the air vents. Do not store your Dell™ computer in a low-airflow environment, such as a closed briefcase, while it is running. Restricting the airflow can damage the computer or cause a fire. The computer turns on the fan when the computer gets hot. Fan noise is normal and does not indicate a problem with the fan or the computer.



NOTICE: Placing or stacking heavy or sharp objects on the computer may result in permanent damage to the computer.

Connecting the AC Adapter

Connect the AC adapter to the computer and then plug it into a wall outlet or surge protector.

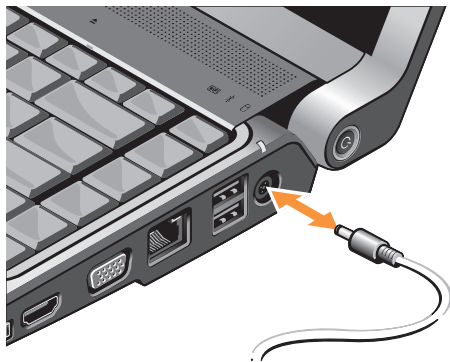

⚠ CAUTION: The AC adapter works with electrical outlets worldwide. However, power connectors and power strips vary among countries. Using an incompatible cable or improperly connecting the cable to a power strip or electrical outlet may cause fire or equipment damage.

➡ NOTICE: When you disconnect the AC adapter cable from the computer, grasp the connector, not the cable itself, and pull firmly, but gently to help prevent damage to the cable.

✍ NOTE: Connect the power cord to the adapter firmly and ensure that the light on the adapter is on when you turn on power.

Connecting the Network Cable (optional)

If you plan to use a wired network connection, plug in the network cable.

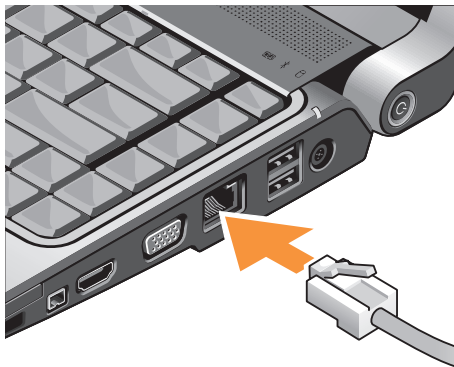

Turning on Your Studio laptop



Using the Wireless Switch

If you plan to use wireless connections, make sure the wireless switch is in the "On" position.

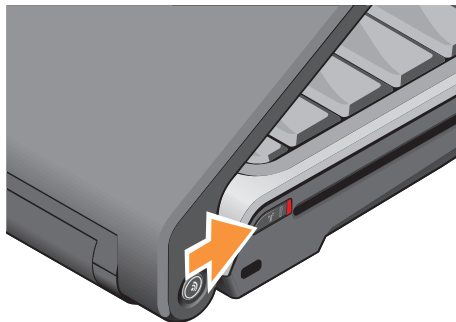

To turn on the wireless switch, slide it from the rear to the front of the computer until it clicks into place.



Windows Vista® Setup

Your Dell computer is preconfigured with Windows Vista. To set up Windows Vista for the first time, follow the instructions on the screen. These steps are mandatory and may take up to 15 minutes to complete. The screens will take you through several procedures including accepting license agreements, setting preferences and setting up an Internet connection.

➔ **NOTICE:** Do not interrupt the operating system's setup process. Doing so may render your computer unusable.

Connecting to the Internet (Optional)

NOTE: ISPs (Internet Service Providers) and ISP offerings vary by country.

To connect to the Internet, you need an external modem or network connection and an Internet service provider (ISP).

NOTE: If an external USB modem or WLAN adapter is not part of your original order you can purchase one from the Dell website at dell.com.

Setting Up a Wired Internet Connection

If you are using a dial-up connection, connect the telephone line to the external USB modem (optional) and to the telephone wall connector before you set up your Internet connection.

If you are using a DSL or cable/satellite modem connection, contact your ISP or cellular telephone service for setup instructions.

Setting Up a Wireless Connection

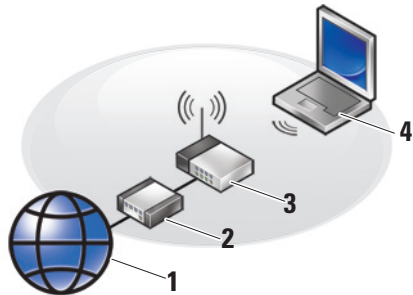

1. Internet service
2. cable or DSL modem
3. wireless router
4. portable computer with wireless network card

See the documentation for your Studio laptop or router for more information about how to set up and use your wireless network.

Setting Up Your Studio Laptop

Before you can use your wireless Internet connection, you need to connect to your wireless router.

To establish connection using a wireless router:

1. Save and close any open files, and exit any open programs.
2. Click **Start**  → **Connect To**.
3. Follow the instructions on the screen to complete the setup.

Setting Up Your Internet Connection

To set up an Internet connection with a provided ISP desktop shortcut:

1. Save and close any open files, and exit any open programs.
2. Double-click the ISP icon on the Microsoft® Windows® desktop.
3. Follow the instructions on the screen to complete the setup.

If you do not have an ISP icon on your desktop or if you want to set up an Internet connection with a different ISP, perform the steps in the following section.

 **NOTE:** If you cannot connect to the Internet but have successfully connected in the past, the ISP might have a service outage. Contact your ISP to check the service status, or try connecting again later.

 **NOTE:** Have your ISP information ready. If you do not have an ISP, the Connect to the Internet wizard can help you get one.

1. Save and close any open files, and exit any open programs.
2. Click **Start**  → **Control Panel**.
3. Under **Network and Internet**, click **Connect to the Internet**.

The **Connect to the Internet** window appears.

4. Click either **Broadband (PPPoE)** or **Dial-up**, depending on how you want to connect:
 - a. Choose **Broadband** if you will use a DSL, satellite modem, cable TV modem, or wireless technology connection.
 - b. Choose **Dial-up** if you will use an optional USB dial-up modem or ISDN.
-  **NOTE:** If you do not know which type of connection to select, click **Help me choose** or contact your ISP.
5. Follow the instructions on the screen and use the setup information provided by your ISP to complete the setup.

Using Your Studio Laptop

Your Studio 1435 has several indicators, buttons, and features that provide information at-a-glance and time-saving shortcuts for common tasks.

Device Status Lights

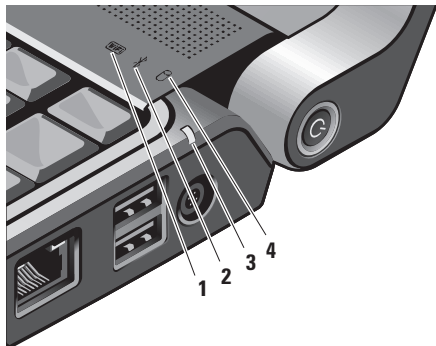



- 1  **WiFi status light** – Turns on when wireless networking is enabled.
See “wireless on/off switch” on page 21 to quickly turn all wireless communication On and Off:

- 2  **Bluetooth® status light (optional)** – Turns on when a card with Bluetooth wireless technology is enabled.

 **NOTE:** The card with Bluetooth wireless technology is an optional feature.

To turn off Bluetooth wireless, right-click the bluetooth icon in the notification area of your desktop, and click **Turn Bluetooth Adapter Off** or see “wireless on/off switch” on page 21.

- 3  **Battery status light** – Indicates the battery charging state:
- Off – the battery is adequately charged or the computer is turned off.
 - Solid white – the battery is charging.
 - Solid orange – the battery charge is low.
 - Flashing orange – the battery charge is critically low and you should either plug in the AC adapter or save and close your open documents and applications until you can.

- 4  **Hard drive activity light** – Turns on when the computer reads or writes data. A flashing light indicates hard drive activity.

 **NOTE:** To avoid loss of data, never turn off the computer while the hard drive activity light is flashing.

Right Side Features

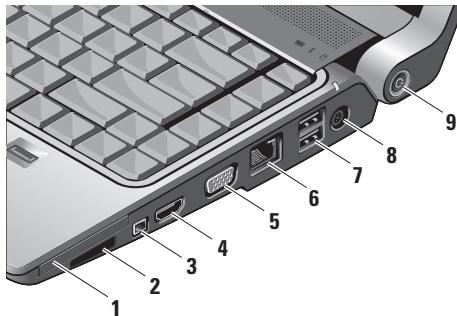

- 1  **ExpressCard slot** – Provides support for additional memory, wired and wireless communications, multimedia, and security features. Supports both 54 mm and 34 mm ExpressCards.

 **NOTE:** The ExpressCard slot is designed only for ExpressCards. It does NOT support PC Cards.

 **NOTE:** Your computer ships with a plastic blank installed in the ExpressCard slot. Blanks protect unused slots from dust and other particles. Save the blank for use when no ExpressCard is installed in the slot; blanks from other computers may not fit your computer.

2  SD/MMC - MS/Pro

8-in-1 Media card reader – Provides a fast and convenient way to view and share digital photos, music, videos, and documents stored on the following digital media memory cards:

- Secure digital (SD) memory card
- Secure Digital Input/Output (SDIO) card
- MultiMedia Card (MMC)
- Memory Stick
- Memory Stick PRO
- xD-Picture Card
- Hi Speed-SD
- Hi Density-SD



 **NOTE:** Your computer ships with a plastic blank installed in the media card slot. Blanks protect unused slots from dust and other particles. Save the blank for use when no media card is installed in the slot. Blanks from other computers may not fit your computer.

3  **IEEE 1394 connector** – Connects high-speed serial multimedia devices that support IEEE 1394, such as some digital video cameras.

4  **HDMI-Out connector** – HDMI-Out (Hi-Definition Multimedia Interface Out) connector carries outgoing data as uncompressed all digital signal to produce hi-definition video and audio. For example, it connects to a TV for both audio and video signals.

 **NOTE:** For a monitor, only the video signal will be read.

5  **VGA connector** – Connects video devices, such as a monitor or projector.

- 6  **Network connector** – If you are using a cabled network signal, this connects your computer to a network or broadband device. The two lights next to the connector indicate status and activity for wired network connections.
- 7  **USB 2.0 connectors (2)** – Connect USB devices, such as a mouse, keyboard, printer, external drive, or MP3 player.
- 8  **AC adapter connector** – Attaches an AC adapter to the computer to power the computer and charge the battery when the computer is not in use. The AC adapter converts AC power to the DC power required by the computer.

For more information, see “Connect the AC Adapter” on 8

- 9  **Power button and light** – Turns the power on or off when pressed.

➡ **NOTICE:** If the computer stops responding, press and hold the power button until the computer turns off completely (may take several seconds).

The light in the center of this button indicates the power state:

- Blinking white – the computer is in sleep state
- Solid white – the computer is in power-on state
- Off – the computer is switched off or in hibernate state

Left Side Features

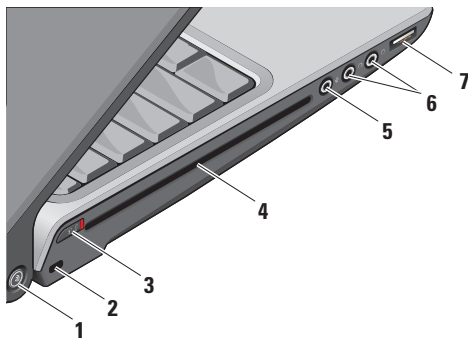

NOTE: Do not use non-standard-size or shape discs (including mini-CDs and mini-DVDs) or you will damage the drive.

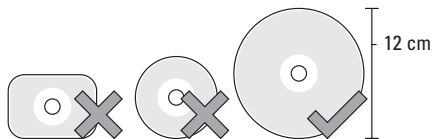

1 Dell Wi-Fi Catcher™ Network Locator button



Turn on the wireless switch and press this button for a few seconds to scan for wireless networks in your vicinity.

NOTE: The Wi-Fi Catcher Network Locator light appears only when the computer is turned off, in Standby mode, or in Hibernate mode and the wireless switch is configured in the system setup program (BIOS) to control Wi-Fi network connections.

NOTE: The Wi-Fi Catcher Network Locator is enabled and configured for use when your computer is shipped to you.

If the computer is turned off, in Standby mode, or in Hibernate mode, the light in the center of this button indicates the searching state:

- Flashing white: Searching for network
- Solid white for 10 seconds then turns off: Network found
- Flashing white turns off after 10 blinks: No signal found

2 Security cable slot – Lets you attach a commercially available antitheft device to the computer.

 **NOTE:** Before you buy an antitheft device, ensure that it works with the security cable slot on your computer.

3  Wireless On/Off switch – Use this switch to quickly turn all wireless devices Off or On such as WLAN cards and internal cards with Bluetooth wireless technology.

The wireless switch may be in the Off position when your computer is shipped to you. To turn the switch On, slide the switch toward the front of the computer until it clicks into place.



 **NOTE:** This switch can be deactivated through Dell QuickSet or the BIOS (system setup program).

4 Optical Drive – Supports only standard-size and shape (12 cm) CDs, and DVDs. Ensure that the side with print or writing is facing upward when inserting discs.

For more information, see the *Dell Technology Guide*.

Using Your Studio Laptop

- 5  **Audio In/ Microphone connector** – Connects to a microphone or input signal for use with audio programs.
- 6  **Audio Out/ Headphone connectors (2)** – Connect to headphones, powered speakers, or sound systems. The audio signal is the same for both connectors.
- 7  **USB connector** – Connects to USB devices, such as a mouse, keyboard, printer, external drive, or MP3 player.

Computer Base and Keyboard Features

- 1 Caps Lock light** – Turns on when using the Caps Lock key.
- 2 Analog Microphone** – If you do not have the optional built-in camera with dual microphones, this single microphone is used for conferencing and chat.
- 3 Consumer IR** – Allows certain software applications to be controlled by the Dell Travel Remote (an optional device that can be stored in the ExpressCard slot when not in use).
- 4 Touch pad buttons** – Provide left-click and right-click functions like those on a mouse.
- 5 Touch pad** – Provides the functionality of a mouse to move the cursor, drag or move selected items, and right-click or left-click by tapping the surface.

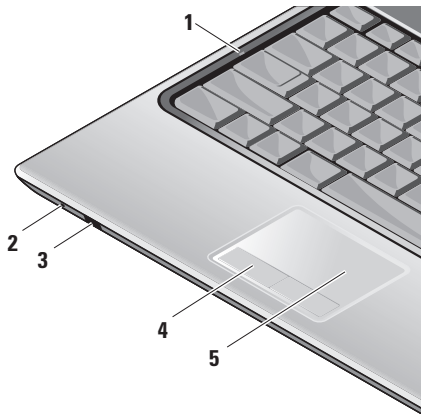

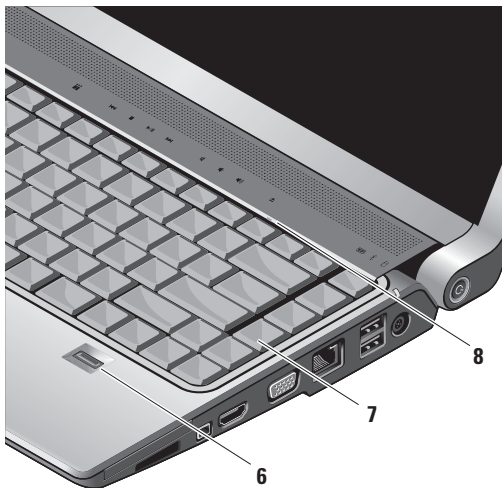

- 6 Fingerprint reader (optional)** – Helps to keep your computer secure. When you slide your finger over the reader, it uses your unique fingerprint to authenticate your user identity (by automating the entry of user names and passwords) using *DigitalPersona Personal* software. To activate and use *Digital Persona Personal*, click **Start** → **Programs** → **DigitalPersona Personal**.

7 Keyboard/ Backlit Keyboard (optional) –

If you have purchased the optional backlit keyboard, the right-arrow key will have the backlit keyboard icon  on it. The optional backlit keyboard provides visibility in dark environments by illuminating all symbols on the keys. The settings for this keyboard can be personalized by using Dell QuickSet. For more information on keyboard, see the *Dell Technology Guide*.



Backlit Keyboard Brightness

Settings – Press <Fn> + right-arrow key to toggle between the three lighting states (in the given order).

The three lighting states are:

- a. full keyboard/touch pad brightness
- b. half keyboard/touch pad brightness
- c. no lighting

8 Num Lock light – Turns on when using the Num Lock key.

Display Features

The display panel holds an optional camera and accompanying dual microphones.

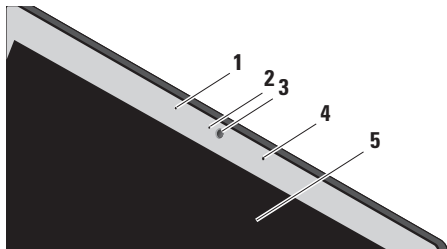

- 1 Left digital array microphone (optional)** – Combines with the right digital array microphone to provide high quality sound for video chatting and voice recording.
- 2 Camera activity indicator (optional)** – Light that indicates when the camera is on and off. Based on selections you made when purchasing your computer, your computer may not include a camera.

- 3 Camera (optional)** – Built-in camera for video capture, conferencing, and chat. Based on the selections you made when purchasing your computer, your computer may not include a camera.

FastAccess facial recognition (optional) – Helps to keep your Dell™ computer secure. This advanced facial recognition software learns your face and minimizes the need for you to use login passwords. For more information, click **Start** → **Programs** → **FastAccess**.

- 4 Right digital array microphone (optional)** – Combines with the left digital array microphone to provide high quality sound for video chatting and voice recording.
- 5 Display** – Your display can vary based on selections you made when purchasing your computer. For more information about displays, see the *Dell Technology Guide*.

Media Controls

To use the media controls, lightly touch the symbol and then release. The control's symbol will shine for 2 seconds to confirm your selection and then fade away.



Launch Dell MediaDirect



Mute the sound



Play the previous track or chapter



Turn down the volume



Stop



Turn up the volume



Play or pause



Eject the disc



Play the next track or chapter

Removing and Replacing the Battery

CAUTION: Using an incompatible battery may increase the risk of fire or explosion. This computer should only use a battery purchased from Dell. Do not use batteries from other computers.

CAUTION: Before removing the battery, shut down the computer, and remove external cables (including the AC adapter).

To remove the battery:

1. Shut down the computer and remove all the external cables.
2. Turn the computer over.
3. Slide the battery release latch towards the side of the computer and hold it in place.
4. Slide the battery out of the bay.

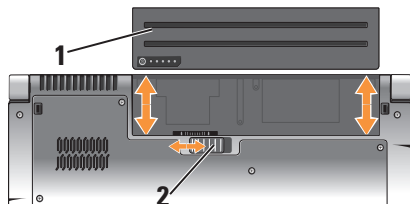

- 1 Battery
- 2 Battery release latch

To replace the battery, slide it into the bay until it clicks into place.

Using the Optical Disc Drive

- ➡ **NOTICE:** Do not use non-standard-size or shape discs (including mini-CDs and mini-DVDs) or you will damage the drive.

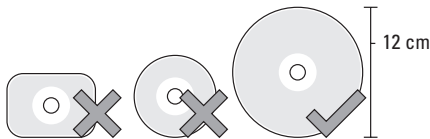

- ✍ **NOTE:** Do not move the computer while playing or recording CDs and DVDs.

Place the disc in the center of the disc slot, with the label facing upwards and gently push the disc into the slot. The drive will automatically pull the disc in and begin reading its content.

- ⏏ To eject a disc from the drive, gently touch the eject control. The control will flash to confirm a few seconds before ejecting the disc.

Software Features

- ✍ **NOTE:** For more information about the features described in this section, see the *Dell Technology Guide* on your hard drive or on the Dell Support website at support.dell.com.

Productivity and Communication

You can use your computer to create presentations, brochures, greeting cards, fliers, and spreadsheets. You can also edit and view digital photographs and images. Check your purchase order for software installed on your computer.

After connecting to the Internet, you can access websites, setup an e-mail account, upload and download files, and so on.

Entertainment and Multimedia

You can use your computer to watch videos, play games, create your own CDs, listen to music and Internet radio stations. Your optical disc drive may supports multiple disc media

Using Your Studio Laptop

formats including CDs, Blu-ray discs (if the option is selected at the time of purchase), and DVDs.

You can download or copy pictures and video files from portable devices, such as digital cameras and cell phones. Optional software applications enable you to organize and create music and video files that can be recorded to disc, saved on portable products such as MP3 players and handheld entertainment devices, or played and viewed directly on connected TVs, projectors, and home theater equipment.

Customizing the Desktop

You can customize your desktop to change the appearance, resolution, wallpaper, screensaver, and so on by accessing the **Personalize appearance and sounds** window.

To access the display properties window:

1. Right-click an open area of the desktop.
2. Click **Personalize**, to open the **Personalize appearance and sounds** window and learn more about your customization options.

Customizing Your Energy Settings

You can use the power options in your operating system to configure the power settings on your computer. Microsoft® Windows Vista® provides three default options:

- **Balanced** — This power option offers full performance when you need it and saves power during periods of inactivity.
- **Power saver** — This power option saves power on your computer by reducing system performance to maximize the life of the computer and by reducing the amount of energy consumed by your computer over its lifetime.
- **High performance** — This power option provides the highest level of system performance on your computer by adapting processor speed to your activity and by maximizing system performance.

Backing Up Your Data

It is recommended that you periodically back up files and folders on your computer. To back up files:

1. Click **Start**  → **Control Panel** → **System and Maintenance** → **Welcome Center** → **Transfer files and settings**.
2. Click **Back up files** or **Back up computer**.
3. Click **Continue on Your User Account Control** dialog box and follow the instructions in the Back up Files wizard.

Solving Problems

This section provides troubleshooting information for your computer. If you cannot solve your problem using the following guidelines, see “Using Support Tools” on page 37 or “Contacting Dell” on page 52.

⚠ CAUTION: Only trained service personnel should remove the computer cover. See the *Service Manual* on the Dell Support website at support.dell.com for advanced service and troubleshooting instructions.

Network Problems

Wireless Connections

If the network connection is lost

— The wireless switch may be off. To turn on the wireless switch, slide it from the rear to the front of the computer until it clicks into place.



— The wireless router is offline or wireless has been disabled on the computer.

- Check your wireless router to ensure it is powered on and connected to your data source (cable modem or network hub).
- Re-establish your connection to the wireless router:
 - a. Save and close any open files, and exit any open programs.
 - b. Click **Start**  → **Connect To**.
 - c. Follow the instructions on the screen to complete the setup.

Wired Connections

If the network connection is lost — The cable is loose or damaged.

- Check the cable to ensure it is plugged in and not damaged.

The link integrity light on the integrated network connector lets you verify that your connection is working and provides information on the status:

- Green — A good connection exists between a 10-Mbps network and the computer.
- Orange — A good connection exists between a 100-Mbps network and the computer.
- Yellow — A good connection exists between a 1000-Mbps network and the computer.
- Off — The computer is not detecting a physical connection to the network.

 **NOTE:** The link integrity light on the network connector is only for the wired cable connection. The link integrity light does not provide status for wireless connections.

Power Problems

If the power light is off — The computer is either turned off or is not receiving power.

- Reseat the power cable into both the power connector on the computer and the electrical outlet.
- If the computer is plugged into a power strip, ensure that the power strip is plugged into an electrical outlet and that the power strip is turned on. Also, temporarily bypass power protection devices, power strips, and power extension cables to verify that the computer turns on properly.
- Ensure that the electrical outlet is working by testing it with another device, such as a lamp.
- Check the AC adapter cable connections. If the AC adapter has a light, ensure that the light on the AC adapter is on.

If the power light is solid white and the computer is not responding — The display may not be responding. Press the power button until the computer turns off and then turn it back on. If the problem persists, see the *Dell Technology Guide* on the Dell Support website at support.dell.com.

Solving Problems

If the power light is blinking white —

The computer is in standby mode. Press a key on the keyboard, move the pointer on the trackpad or a connected mouse, or press the power button to resume normal operation.

If you encounter interference that hinders reception on your computer — An unwanted signal is creating interference by interrupting or blocking other signals. Some possible causes of interference are:

- Power, keyboard, and mouse extension cables.
- Too many devices connected to a power strip.
- Multiple power strips connected to the same electrical outlet.

Memory Problems

If you receive an insufficient memory message—

- Save and close any open files and exit any open programs you are not using to see if that resolves the problem.

- See the software documentation for minimum memory requirements. If necessary, install additional memory (See the *Service Manual* on the Dell Support website at support.dell.com).
- Reseat the memory modules (See the *Service Manual* on the Dell Support website at support.dell.com) to ensure that your computer is successfully communicating with the memory.

If you experience other memory problems —

- Ensure that you are following the memory installation guidelines (see the *Service Manual* on the Dell Support website at support.dell.com).
- Check if the memory module is compatible with your computer. Your computer supports DDR2 memory. For more information about the type of memory supported by your computer, see “Basic Specifications” on page 56.
- Run the Dell Diagnostics (see “Dell Diagnostics” on page 40).

- Reseat the memory modules (see the *Service Manual* on the Dell Support website at support.dell.com) to ensure that your computer is successfully communicating with the memory.

Lockups and Software Problems

If the computer does not start up — Ensure that the power cable is firmly connected to the computer and to the electrical outlet.

If a program stops responding — End the program:

1. Press <Ctrl><Shift><Esc> simultaneously.
2. Click **Applications**.
3. Click the program that is no longer responding
4. Click **End Task**.

If a program crashes repeatedly — Check the software documentation. If necessary, uninstall and then reinstall the program.

 **NOTE:** Software usually includes installation instructions in its documentation or on CD.

If the computer stops responding —

 **NOTICE:** You might lose data if you are unable to perform an operating system shutdown.

Turn the computer off. If you are unable to get a response by pressing a key on your keyboard or moving your mouse, press and hold the power button for at least 8 to 10 seconds until the computer turns off. Then restart your computer.

If a program is designed for an earlier Microsoft® Windows® operating system —

Run the Program Compatibility Wizard. The Program Compatibility Wizard configures a program so that it runs in an environment similar to non-Windows Vista operating system environments.

1. Click **Start**  → **Control Panel** → **Programs** → **Use an older program with this version of Windows**.

Solving Problems

2. In the welcome screen, click **Next**.
3. Follow the instructions on the screen.

If a solid blue screen appears — Turn the computer off. If you are unable to get a response by pressing a key on your keyboard or moving your pointer or mouse, press and hold the power button for at least 8 to 10 seconds until the computer turns off. Then restart your computer.

If you have other software problems —

- Back up your files immediately.
 - Use a virus-scanning program to check the hard drive or CDs.
 - Save and close any open files or programs and shut down your computer through the **Start**  menu.
- Check the software documentation or contact the software manufacturer for troubleshooting information:
 - Ensure that the program is compatible with the operating system installed on your computer.
 - Ensure that your computer meets the minimum hardware requirements needed to run the software. See the software documentation for information.
 - Ensure that the program is installed and configured properly.
 - Verify that the device drivers do not conflict with the program.
 - If necessary, uninstall and then reinstall the program.

Using Support Tools

Dell Support Center

The Dell Support Center helps you find the service, support, and system-specific information you need. For more information about Dell Support Center and available support tools, click the **Services** tab at support.dell.com.



Click the  icon in the taskbar to run the application. The home page provides links to access:

- Self Help (Troubleshooting, Security, System Performance, Network/Internet, Backup/Recovery, and Windows Vista)
- Alerts (technical support alerts relevant to your computer)

- Assistance from Dell (Technical Support with DellConnect™, Customer Service, Training and Tutorials, How-To Help with Dell on Call, and Online Scan with PCCheckUp)
- About Your System (System Documentation, Warranty Information, System Information, Upgrades & Accessories)

The top of the Dell Support Center home page displays your computer's model number along with its service tag and express service code.

For more information about the Dell Support Center, see the *Dell Technology Guide* on your hard drive or on the Dell Support website at support.dell.com.

System Messages

If your computer has an issue or error, it may display a System Message that will help you identify the cause and action needed to resolve the issue.

 **NOTE:** If the message you received is not listed in the following examples, see the documentation for either the operating system or the program that was running when the message appeared. Alternatively you could see the *Dell Technology Guide* on your computer or on the Dell Support website at support.dell.com or see “Contacting Dell” on page 52 for assistance.

Alert! Previous attempts at booting this system have failed at checkpoint [nnnn]. For help in resolving this problem, please note this checkpoint and contact Dell Technical Support — The computer failed to complete the boot routine three consecutive times for the same error see “Contacting Dell” on page 52 for assistance.

CMOS checksum error — Possible motherboard failure or RTC battery low. Replace the battery. See the *Service Manual* on the Dell Support website at support.dell.com or see “Contacting Dell” on page 52 for assistance.

CPU fan failure — CPU fan has failed. Replace the CPU fan. See the *Service Manual* on the Dell Support website at support.dell.com.

Hard-disk drive failure — Possible hard disk drive failure during POST see “Contacting Dell” on page 52 for assistance.

Hard-disk drive read failure — Possible hard disk drive failure during HDD boot test see “Contacting Dell” on page 52 for assistance.

Keyboard failure — Keyboard failure or loose cable.

No boot device available — No bootable partition on hard disk drive, the hard disk drive cable is loose, or no bootable device exists.

- If the hard drive is your boot device, ensure that the cables are connected and that the drive is installed properly and partitioned as a boot device.
- Enter system setup and ensure that the boot sequence information is correct (see *Dell Technology Guide* on your computer or on the Dell Support website at support.dell.com).

No timer tick interrupt — A chip on the system board might be malfunctioning or motherboard failure (see “Contacting Dell” on page 52 for assistance).

USB over current error — Disconnect the USB device. Your USB device needs more power for it to function properly. Use an external power source to connect the USB device, or if your device has two USB cables, connect both of them.

NOTICE - Hard Drive SELF MONITORING SYSTEM has reported that a parameter has exceeded its normal operating range.

Dell recommends that you back up your data regularly. A parameter out of range may or may not indicate a potential hard drive problem — S.M.A.R.T error, possible hard disk drive failure. This feature can be enabled or disabled in the BIOS setup (see “Contacting Dell” on page 52 for assistance).

Hardware Troubleshooter

If a device is either not detected during the operating system setup or is detected but incorrectly configured, you can use the **Hardware Troubleshooter** to resolve the incompatibility.

To start the Hardware Troubleshooter:

1. Click **Start**  → **Help and Support**.
2. Type `hardware troubleshooter` in the search field and press <Enter> to start the search.
3. In the search results, select the option that best describes the problem and follow the remaining troubleshooting steps.

Dell Diagnostics

If you experience a problem with your computer, perform the checks in “Lockups and Software Problems” on page 56 and run the Dell Diagnostics before you contact Dell for technical assistance.

It is recommended that you print these procedures before you begin.

 **NOTICE:** Dell Diagnostics works only on Dell computers.

 **NOTE:** The *Drivers and Utilities* media is optional and may not ship with your computer.

Review your computer’s configuration information, and ensure that the device that you want to test displays in the system setup program and is active. See the System Setup section in *Dell Technology Guide*.

Start the Dell Diagnostics from your hard drive or from the *Drivers and Utilities* media.

Starting Dell Diagnostics From Your Hard Drive

The Dell Diagnostics is located on a hidden diagnostic utility partition on your hard drive.

 **NOTE:** If your computer cannot display a screen image, see “Contacting Dell” on page 52.

1. Ensure that the computer is connected to an electrical outlet that is known to be working properly.
2. Turn on (or restart) your computer.
3. When the DELL™ logo appears, press <F12> immediately. Select **Diagnostics** from the boot menu and press <Enter>.

 **NOTE:** If you wait too long and the operating system logo appears, continue to wait until you see the Microsoft® Windows® desktop; then, shut down your computer and try again.

 **NOTE:** If you see a message stating that no diagnostics utility partition has been found, run the Dell Diagnostics from the *Drivers and Utilities* media.

4. Press any key to start the Dell Diagnostics from the diagnostics utility partition on your hard drive.

Starting Dell Diagnostics From the Drivers and Utilities Media

1. Insert the *Drivers and Utilities* media.
2. Shut down and restart the computer.
When the DELL logo appears, press <F12> immediately.

 **NOTE:** If you wait too long and the operating system logo appears, continue to wait until you see the Microsoft® Windows® desktop; then, shut down your computer and try again.

 **NOTE:** The next steps change the boot sequence for one time only. On the next start-up, the computer boots according to the devices specified in the system setup program.

3. When the boot device list appears, highlight **CD/DVD/CD-RW** and press <Enter>.
4. Select the **Boot from CD-ROM** option from the menu that appears and press <Enter>.
5. Type 1 to start the CD menu and press <Enter> to proceed.
6. Select **Run the 32 Bit Dell Diagnostics** from the numbered list. If multiple versions are listed, select the version appropriate for your computer.
7. When the Dell Diagnostics **Main Menu** appears, select the test you want to run.

Restoring Your Operating System

You can restore your operating system in the following ways:

- System Restore returns your computer to an earlier operating state without affecting data files. Use System Restore as the first solution for restoring your operating system and preserving data files.
- Dell Factory Image Restore returns your hard drive to the operating state it was in when you purchased the computer. This procedure permanently deletes all data on the hard drive and removes any programs installed after you received the computer. Use Dell Factory Image Restore only if System Restore did not resolve your operating system problem.
- If you received an Operating System disc with your computer, you can use it to restore your operating system. However, using the Operating System disc also deletes all data

on the hard drive. Use the disc only if System Restore did not resolve your operating system problem.

System Restore

The Windows operating systems provide a System Restore option which allows you to return your computer to an earlier operating state (without affecting data files) if changes to the hardware, software, or other system settings have left the computer in an undesirable operating state. Any changes that System Restore makes to your computer are completely reversible.

 **NOTICE:** Make regular backups of your data files. System Restore does not monitor your data files or recover them.

 **NOTE:** The procedures in this document were written for the Windows default view, so they may not apply if you set your Dell™ computer to the Windows Classic view.

Starting System Restore

1. Click **Start** .
2. In the **Start Search** box, type `System Restore` and press <Enter>.

 **NOTE:** The **User Account Control** window may appear. If you are an administrator on the computer, click **Continue**; otherwise, contact your administrator to continue the desired action.

3. Click **Next** and follow the remaining prompts on the screen.

In the event that System Restore did not resolve the issue, you may undo the last system restore.

Undoing the Last System Restore

 **NOTE:** Before you undo the last system restore, save and close all open files and exit any open programs. Do not alter, open, or delete any files or programs until the system restoration is complete.

1. Click **Start** .
2. In the **Start Search** box, type `System Restore` and press <Enter>.
3. Click **Undo my last restoration** and click **Next**.

Dell Factory Image Restore

 **NOTICE:** Using Dell Factory Image Restore permanently deletes all data on the hard drive and removes any programs or drivers installed after you received your computer. If possible, back up the data before using these options. Use Dell Factory Image Restore only if System Restore did not resolve your operating system problem.



 **NOTE:** Dell Factory Image Restore may not be available in certain countries or on certain computers.

Use Dell Factory Image Restore only as the last method to restore your operating system. These options restore your hard drive to the

Restoring Your Operating System

operating state it was in when you purchased the computer. Any programs or files added since you received your computer—including data files—are permanently deleted from the hard drive. Data files include documents, spreadsheets, e-mail messages, digital photos, music files, and so on. If possible, back up all data before using Factory Image Restore.

Dell Factory Image Restore

1. Turn on the computer. When the Dell logo appears, press <F8> several times to access the **Vista Advanced Boot Options** Window.
2. Select **Repair Your Computer**.
3. The **System Recovery Options** window appears.
4. Select a keyboard layout and click **Next**.
5. To access the recovery options, log on as a local user. To access the command prompt, type `administrator` in the **User name** field, then click **OK**.
6. Click **Dell Factory Image Restore**. The **Dell Factory Image Restore** welcome screen appears.
 -  **NOTE:** Depending upon your configuration, you may need to select **Dell Factory Tools**, then **Dell Factory Image Restore**.
7. Click **Next**. The **Confirm Data Deletion** screen appears.
 -  **NOTICE:** If you do not want to proceed with Factory Image Restore, click **Cancel**.
8. Click the checkbox to confirm that you want to continue reformatting the hard drive and restoring the system software to the factory condition, then click **Next**.

The restore process begins and may take five or more minutes to complete. A message appears when the operating system and factory-installed applications have been restored to factory condition.
9. Click **Finish** to reboot the system.

Operating System Reinstallation

Before you Begin

If you are considering reinstalling the Windows operating system to correct a problem with a newly installed driver, first try using Windows Device Driver Rollback. If Device Driver Rollback does not resolve the problem, then use System Restore to return your operating system to the operating state it was in before you installed the new device driver. See “Using Microsoft Windows System Restore” on page 42.

➡ **NOTICE:** Before performing the installation, back up all data files on your primary hard drive. For conventional hard drive configurations, the primary hard drive is the first drive detected by the computer.

To reinstall Windows, you need the following items:

- *Dell Operating System* media
- *Dell Drivers and Utilities* media

 **NOTE:** The *Dell Drivers and Utilities* media contains drivers that were installed during the assembly of the computer. Use the Dell Drivers and Utilities media to load any required drivers. Depending on the region from which you ordered your computer, or whether you requested the media, the *Dell Drivers and Utilities* media and *Operating System* media may not ship with your computer.

Reinstalling Windows Vista

The reinstallation process can take 1 to 2 hours to complete. After you reinstall the operating system, you must also reinstall the device drivers, virus protection program, and other software.

1. Save and close any open files and exit any open programs.
2. Insert the *Operating System* disc.
3. Click **Exit** if the **Install Windows** message appears.

Restoring Your Operating System

4. Restart the computer.
5. When the DELL logo appears, press <F12> immediately.

 **NOTE:** If you wait too long and the operating system logo appears, continue to wait until you see the Microsoft® Windows® desktop; then, shut down your computer and try again.

 **NOTE:** The next steps change the boot sequence for one time only. On the next start-up, the computer boots according to the devices specified in the system setup program.

6. When the boot device list appears, highlight **CD/DVD/CD-RW Drive** and press <Enter>.
7. Press any key to **Boot from CD-ROM**. Follow the instructions on the screen to complete the installation.

Getting Help

If you experience a problem with your computer, you can complete the following steps to diagnose and troubleshoot the problem:

1. See “Solving Problems” on page 32 for information and procedures that pertain to the problem your computer is experiencing.
2. See “Dell Diagnostics” on page 40 for procedures on how to run Dell Diagnostics.
3. Fill out the “Diagnostic Checklist” on page 51.
4. Use Dell’s extensive suite of online services available at Dell Support (support.dell.com) for help with installation and troubleshooting procedures. See “Online Services” on page 48 for a more extensive list of Dell Support online.
5. If the preceding steps have not resolved the problem, see “Contacting Dell” on page 52.

 **NOTE:** Call Dell Support from a telephone near or at the computer so that the support staff can assist you with any necessary procedures.

 **NOTE:** Dell’s Express Service Code system may not be available in all countries.

When prompted by Dell’s automated telephone system, enter your Express Service Code to route the call directly to the proper support personnel. If you do not have an Express Service Code, open the **Dell Accessories** folder, double-click the **Express Service Code** icon, and follow the directions.

 **NOTE:** Some of the following services are not always available in all locations outside the continental U.S. Call your local Dell representative for information on availability.

Technical Support and Customer Service

Dell's support service is available to answer your questions about Dell hardware. Our support staff uses computer-based diagnostics to provide fast, accurate answers.

To contact Dell's support service, see "Before You Call" on page 51 and then see the contact information for your region or go to support.dell.com.

DellConnect™

DellConnect is a simple online access tool that allows a Dell service and support associate to access your computer through a broadband connection, diagnose your problem and repair it all under your supervision. For more information, go to support.dell.com and click **DellConnect**.

Online Services

You can learn about Dell products and services on the following websites:

- www.dell.com
- www.dell.com/ap (Asian/Pacific countries only)
- www.dell.com/jp (Japan only)
- www.euro.dell.com (Europe only)
- www.dell.com/la (Latin American and Caribbean countries)
- www.dell.ca (Canada only)

You can access Dell Support through the following websites and e-mail addresses:

Dell Support websites

- support.dell.com
- support.jp.dell.com (Japan only)
- support.euro.dell.com (Europe only)

Dell Support e-mail addresses

- mobile_support@us.dell.com

- **support@us.dell.com**
- **la-techsupport@dell.com** (Latin America and Caribbean countries only)
- **apsupport@dell.com** (Asian/Pacific countries only)

Dell Marketing and Sales e-mail addresses

- **apmarketing@dell.com** (Asian/Pacific countries only)
- **sales_canada@dell.com** (Canada only)

Anonymous file transfer protocol (FTP)

- **ftp.dell.com**

Log in as user: `anonymous`, and use your e-mail address as your password.

AutoTech Service

Dell's automated support service—AutoTech—provides recorded answers to the questions most frequently asked by Dell customers about their portable and desktop computers.

When you call AutoTech, use your touch-tone telephone to select the subjects that correspond to your questions. For instructions on accessing the telephone number to call your region, see “Contacting Dell” on page 52.

Automated Order-Status Service

To check on the status of any Dell products that you have ordered, you can go to **support.dell.com**, or you can call the automated order-status service. A recording prompts you for the information needed to locate and report on your order. For the telephone number to call your region, see “Contacting Dell” on page 52 for problems with your order.

If you have a problem with your order, such as missing parts, wrong parts, or incorrect billing,

Getting Help

contact Dell for customer assistance. Have your invoice or packing slip handy when you call.

For the telephone number to call for your region, see “Contacting Dell” on page 52.

Product Information

If you need information about additional products available from Dell, or if you would like to place an order, visit the Dell website at **www.dell.com**. For the telephone number to call for your region or to speak to a sales specialist, see “Contacting Dell” on page 52.

Returning Items for Repair Under Warranty or for Credit

Prepare all items being returned, whether for repair or credit, as follows:

1. Call Dell to obtain a Return Material Authorization Number, and write it clearly and prominently on the outside of the box.
2. For the telephone number to call for your region, see “Contacting Dell” on page 52.
3. Include a copy of the invoice and a letter describing the reason for the return.
4. Include a copy of the Diagnostics Checklist (see “Diagnostic Checklist” on page 51), indicating the tests that you have run and any error messages reported by the Dell Diagnostics (see “Dell Diagnostics” on page 40).
5. Include any accessories that belong with the item(s) being returned (power cables, software, guides, and so on) if the return is for credit.
6. Pack the equipment to be returned in the original (or equivalent) packing materials.
7. You are responsible for paying shipping expenses. You are also responsible for insuring any product returned, and you assume the risk of loss during shipment to Dell. Collect On Delivery (C.O.D.) packages are not accepted.
8. Returns that are missing any of the preceding requirements will be refused at Dell’s receiving dock and returned to you.

Before You Call

 **NOTE:** Have your Express Service Code ready when you call. The code helps Dell's automated-support telephone system direct your call more efficiently. You may also be asked for your Service Tag (located on the back or bottom of your computer).

Remember to fill out the following Diagnostics Checklist. If possible, turn on your computer before you call Dell for assistance and call from a telephone at or near the computer. You may be asked to type some commands at the keyboard, relay detailed information during operations, or try other troubleshooting steps possible only at the computer itself. Ensure that the computer documentation is available.

Diagnostic Checklist

- Name:
- Date:
- Address:
- Phone number:
- Service Tag (bar code on the back or bottom of the computer):
- Express Service Code:
- Return Material Authorization Number (if provided by Dell support technician):
- Operating system and version:
- Devices:
- Expansion cards:
- Are you connected to a network? Yes /No
- Network, version, and network adapter:
- Programs and versions:

Getting Help

See your operating system documentation to determine the contents of the computer's start-up files. If the computer is connected to a printer, print each file. Otherwise, record the contents of each file before calling Dell.

- Error message, beep code, or diagnostic code:
- Description of problem and troubleshooting procedures you performed:

Contacting Dell

For customers in the United States, call 800-WWW-DELL (800-999-3355).

 **NOTE:** If you do not have an active Internet connection, you can find contact information on your purchase invoice, packing slip, bill, or Dell product catalog.

Dell provides several online and telephone-based support and service options. Availability varies by country and product, and some services may not be available in your area.

To contact Dell for sales, technical support, or customer service issues:

1. Visit **support.dell.com**.
2. Verify your country or region in the **Choose A Country/Region** drop-down menu at the bottom of the page.
3. Click **Contact Us** on the left side of the page.
4. Select the appropriate service or support link based on your need.
5. Choose the method of contacting Dell that is convenient for you.

Finding More Information and Resources

If you need to:

reinstall your operating system.

run a diagnostic program for your computer, reinstall notebook system software, or update drivers for your computer, and readme files.

learn more about your operating system, maintaining peripherals, RAID, Internet, Bluetooth®, networking, and e-mail.

upgrade your computer with new or additional memory, or a new hard drive.

reinstall or replace a worn or defective part.

See:

the Operating System disc.

the *Drivers and Utilities* disc.



NOTE: Drivers and documentation updates can be found on the Dell™ Support website at **support.dell.com**.

the *Dell Technology Guide* installed on your hard drive.

the *Service Manual* on the Dell Support website at **support.dell.com**



NOTE: In some countries, opening and replacing parts of your computer may void your warranty. Check your warranty and return policies before working inside your computer.

If you need to:

find safety best practices information for your computer

review Warranty information, Terms and Conditions (U.S. only), Safety instructions, Regulatory information, Ergonomics information, and End User License Agreement.

find your Service tag/Express Service Code— You must use the service tag to identify your computer on **support.dell.com** or to contact technical support.

find drivers and downloads.

access technical support and product help.

check on your order status for new purchases.

find solutions and answers to common questions.

locate information for last-minute updates about technical changes to your computer or advanced technical-reference material for technicians or experienced users.

See:

the safety and regulatory documents that shipped with your computer and also see the Regulatory Compliance Homepage on **www.dell.com** at the following location: **www.dell.com/regulatory_compliance**.

the back or bottom of your computer.

the Dell™ Support website at **support.dell.com**.

Basic Specifications

System Model

Dell Studio 1435

This section provides basic information that you may need when setting up, updating drivers for, and upgrading your computer.



NOTE: Offerings may vary by region.

For more information regarding the configuration of your computer, click

Start  → **Help and Support** and select the option to view information about your computer.

Processor

Processor type

- Intel® Celeron® (availability varies by regions)
- Intel® Dual-Core
- Intel® Core™ 2 Duo
- Intel® Pentium® Dual-Core

L1 cache

64 KB (Intel - 32 KB per core)

L2 cache

512 KB

1 MB (Intel Celeron, Intel Dual-Core)

2 MB or 3 MB or 6 MB (Intel Core2 Duo)

Processor

External bus frequency	533 MHz (Intel Celeron, Intel Dual-Core)
Front Side Bus (Intel)	800/667 MHz (Intel Core2 Duo)

System Information

System chipset	Intel GM/PM965
Data bus width	64 bits
DRAM bus width	dual-channel (2) 64-bit buses
Processor address bus width	36 bits
Flash EPROM	2 MB

System Information

Graphics bus	PCI-E X16
PCI bus	32 bits

(PCI-Express used for video controllers)

ExpressCard

 **NOTE:** The ExpressCard slot is designed only for ExpressCards. It does NOT support PC Cards.

 **NOTE:** PCMCIA may not be available in some regions.

ExpressCard controller	Intel ICH8M
ExpressCard connector	one ExpressCard slot (54 mm)

Basic Specifications

ExpressCard

Cards supported	ExpressCard/34 (34 mm) ExpressCard/54 (54 mm) 1.5 V and 3.3 V
ExpressCard connector size	26 pins

Memory

Memory module connector	two user-accessible SODIMM connectors
Memory module capacities	512 MB, 1 GB, and 2 GB
Memory type	800 MHz SODIMM DDR2 (Studio 1435 supports up to 667 MHz)
Minimum memory configuration	1 GB

Memory

Maximum memory configuration 4 GB

 **NOTE:** In order to take advantage of the dual channel bandwidth capability, both memory slots must be populated and must match in size.

 **NOTE:** The available memory displayed does not reflect the complete maximum memory installed because some memory is reserved for system files.

 **NOTE:** For instructions on upgrading memory, see the *Service Manual* on the Dell Support website at support.dell.com.

8-in-1 Memory Card Reader

Card controller	Ricoh R5C833
Card connector	8-in-1 combo single slot
Cards supported	<ul style="list-style-type: none"> • Secure Digital (SD) • Secure Digital Input/Output (SDIO), • MultiMediaCard (MMC), • Memory Stick • Memory Stick PRO • xD-Picture Card • Hi Capacity-SD • Hi Density-SD

Ports and Connectors

Audio	microphone-in connector, two stereo headphones/speakers connector
IEEE 1394a	4-pin mini, non-powered connector
Consumer IR	sensor compatible with Philips RC6 (receive only)
Mini-Card	two Type IIIA Mini-Card slots, one half-size Mini-Card slot
HDMI connector	19-pin
Network adapter	RJ-45 port
USB	three 4-pin USB 2.0-compliant connector
Video	15-hole connector

Basic Specifications

Communications

Modem:	
Type	External V.92 56K USB Modem
Controller Interface	Hardware Modem Universal Serial Bus (USB)
Network adapter	10/100/1000 Ethernet LAN on system board
Wireless	internal WLAN (half-size Mini-Card) and WPAN (full-size Mini-Card, Bluetooth® wireless technology) Bluetooth® wireless technology

Video

Discrete:	
Video type	integrated on system board
Video controller	ATI Mobility Radeon HD 3450
Video memory	256 MB DDR3 technology
UMA:	
Video type	integrated on system board
Video controller	Intel 965 GM
Video memory	up to 358 MB of shared memory
LCD interface	Low Voltage Differential Signaling (LVDS)
TV support	HDMI 1.2

Audio

Audio type	5.1 channel High Definition Audio
Audio controller	Realtek ALC888
Stereo conversion	24-bit (analog-to-digital and digital-to-analog)
Interfaces:	
Internal	Intel High Definition Audio microphone in/line
External	in/surround line out connector, two stereo headphones/ speakers connector
Speaker	two 4-ohm speakers
Internal speaker amplifier	2 Watts per channel into 4 ohms
Volume controls	program menus and media control buttons

Camera (optional)

Pixel	2.0 mega pixel
Video Resolution	320x240 ~1600x1200 (640x480 at 30 fps)
Diagonal Viewing Angle	66°

Media

Drive	CD / DVD Writer (Dual Layer DVD+/-RW Drive) Blu-ray Disc™ (BD) (optional)
Interface	Roxio® Creator® DE or Roxio® Creator® Premier Blu-ray (for Blu-ray Disc™) Dell MediaDirect™

Basic Specifications

Display

 **NOTE:** Panel offering subject to availability.

Types and Native Resolutions at 262K colors	14.1-inch WXGA TrueLife – 1280 x 3 (RGB) x 800
	14.1-inch WLED WXGA TrueLife – 1280 x 3 (RGB) x 800
	14.1-inch WLED WXGA+ TrueLife – 1440 x 3 (RGB) x 900
Refresh rate	60 Hz
Operating angle	0° (closed) to 140°

Display

Viewing angles:

Horizontal	±40° (WXGA TrueLife) min. ±40° (WLED WXGA TrueLife) min. ±50° (WLED WXGA+ TrueLife) min.
Vertical	+15°/–30° (WXGA TrueLife) min. +15°/–30° (WLED WXGA TrueLife) min. +40°/–50° (WLED WXGA+ TrueLife) min.

Display*Pixel pitch:*

WXGA TrueLife	0.2373 mm
------------------	-----------

WLED WXGA TrueLife	0.2373 mm
-----------------------	-----------

WLED WXGA+ TrueLife	0.2109 mm
------------------------	-----------

Controls	brightness can be controlled through keyboard shortcuts (see <i>Dell Technology Guide</i> for more information)
----------	---

Keyboard

Number of keys	86 (U.S. and Canada); 87 (International); 90 (Japan); 87 (Brazil)
----------------	---

Layout	QWERTY/AZERTY/Kanji
--------	---------------------

Touch Pad

X/Y position resolution (graphics table mode)	240 cpi
--	---------

Size:

Width	71.7-mm (2.8-in) sensor-active area
-------	--

Height	34.0-mm (1.3-in) rectangle
--------	----------------------------

Basic Specifications

Battery

Types and dimensions:

9-cell 85Wh "smart" lithium ion
depth - 49.95 mm (1.96 in)
height - 39.6 mm (1.56 in)
width - 266.04 mm (10.47 in)
weight - 0.49kg (1.08 lb)

6-cell 56Wh "smart" lithium ion
depth - 49.95 mm (1.96 in)
height - 20.4 mm (0.8 in)
width - 204.9 mm (8.06 in)
weight - 0.33kg (0.72 lb)

4-cell 37Wh "smart" lithium ion
depth - 49.95 mm (1.96 in)
height - 20.4 mm (0.8 in)
width - 204.9 mm (8.06 in)
weight - 0.24kg (0.53 lb)

Voltage
11.1 VDC (6/9 cell)
14.8 VDC (4 cell)

Charge time (approximate):

Computer off 4 hours

Battery

Operating time Battery operating time varies depending on operating conditions and can be significantly reduced under certain power-intensive conditions.

See *Dell Technology Guide* for more information on battery life.

Life span (approximate) 300 discharge/charge cycles

Temperature range Operating: 0° to 35°C (32° to 95°F)

Storage: -40° to 65°C (-40° to 149°F)

Coin-cell battery CR-2032

AC Adapter

Types	65 W, 90 W
Input voltage	100–240 VAC
Input current (maximum)	1.5 A
Input frequency	50–60 Hz
<i>Output current:</i>	
65 W	3.3.4 A (continuous)
90 W	4.62 A (continuous)
Output power	65 W or 90 W
Rated output voltage	19.5 VDC

AC Adapter

<i>Dimensions:</i>	
65 W:	
Height	16 mm (0.6 inches)
Width	66 mm (2.6 inches)
Length	127 mm (5.0 inches)
90 W:	
Height	16 mm (0.6 inches)
Width	70 mm (2.8 inches)
Length	147 mm (5.8 inches)
<i>Weight (without AC power cord):</i>	
65 W	0.29 kg (0.64 lb)
90 W	0.345 kg (0.76 lb)
Temperature range:	
Operating	0° to 40°C (32° to 104°F)

Basic Specifications

AC Adapter

Storage -40° to 70°C (-40° to 158°F)

Connector types:

DC connector 3 pin, 7.4 mm plug

AC connector 2 pin - C7 (Japan only)
3 pin - C5

Physical

Height 25.4 mm~39.2
(1.0 in~1.54 in)

Width 334.1 mm (1.09 in)

Depth 246.0 mm (9.68 in)

Weight (with 4-cell battery) configurable to less than 2.36 kg (5.2 lbs)

Environmental

Temperature range Operating: 0° to 35°C (32° to 95°F)

Storage: -40° to 65°C (-40° to 149°F)

Relative humidity (maximum): Operating: 10% to 90% (noncondensing)

Storage: 10% to 95% (noncondensing)

Maximum vibration (using a random vibration spectrum that simulates user environment):

Operating 0.66 GRMS

Storage 1.3 GRMS

Maximum shock (Measured with hard drive in operating status and a 2-ms half-sine pulse for operating. Also measured with hard drive in head-parked position and a 2-ms halfsine pluse for storage):

Environmental

Operating	110 G
Storage	160 G
Altitude (maximum)	Operating: -15.2 to 3048 m (-50 to 10,000 ft) Storage: -15.2 to 10,668 m (-50 to 35,000 ft)
Airborne contaminant level	G2 or lower as defined by ISA-S71.04-1985

Appendix

Macrovision Product Notice

This product incorporates copyright protection technology that is protected by method claims of certain U.S. patents and other intellectual property rights owned by Macrovision Corporation and other rights owners. Use of this copyright protection technology must be authorized by Macrovision Corporation, and is intended for home and other limited viewing uses only unless otherwise authorized by Macrovision Corporation. Reverse engineering or disassembly is prohibited.

Index

A

- airflow, allowing **7**
- AutoTech **49**

B

- backups
 - creating **31**

C

- calling Dell **51**
- CDs, playing and creating **29**
- computer capabilities **29**
- computer, setting up **7**
- computer stand **8**
- connect(ing)
 - to the Internet **11**
- conserving energy **30**

- Contacting Dell online **52**
- customer service **48**
- customizing
 - your desktop **30**
 - your energy settings **30**

D

- damage, avoiding **7**
- data, backing up **31**
- DellConnect **48**
- Dell Diagnostics **40**
- Dell Factory Image Restore **42**
- Dell Support Center **37**
- Dell support website **55**

Index

Dell Technology Guide

for further information **54**

device status lights **14**

Diagnostic Checklist **51**

disc drive

supported disc sizes **29**

discs

ejecting **29**

using **29**

drivers and downloads **55**

DVDs, playing and creating **30**

E

email addresses

for technical support **48**

energy

conserving **30**

F

finding more information **54**

FTP login, anonymous **49**

H

hardware problems

diagnosing **39**

Hardware Troubleshooter **39**

help

getting assistance and support **47**

horizontal and vertical stand options **8**

I

installing the stand **8**

Internet connection **11**

ISP

Internet Service Provider **11**

M

memory problems
 solving **34**

N

network connection
 fixing **32**
network speed
 testing **32**

O

order status **49**

P

power problems, solving **33**
power strips, using **8**
problems, solving **32**
products
 information and purchasing **50**

R

reinstalling Windows **42**
resources, finding more **54**
restoring factory image **43**

S

setup, before you begin **7**
shipping products
 for return or repair **50**
software features **29**
software problems **35**
solving problems **32**
specifications **56**
support email addresses **48**
support sites
 worldwide **48**

Index

System Messages **38**

system reinstall options **42**

System Restore **42**

T

technical support **48**

V

ventilation, ensuring **7**

W

warranty returns **50**

Windows, reinstalling **42**

Windows Vista® **10**

 Program Compatibility Wizard **35**

 reinstalling **45**

 setup **10**

wired network

 network cable, connecting **9**

wireless network connection **32**

wireless switch **10, 32**

Printed in Malaysia.

www.dell.com | support.dell.com



0P479CA00

Printed in China.

Printed on recycled paper.

www.dell.com | support.dell.com



0P479CA00

Free Manuals Download Website

<http://myh66.com>

<http://usermanuals.us>

<http://www.somanuals.com>

<http://www.4manuals.cc>

<http://www.manual-lib.com>

<http://www.404manual.com>

<http://www.luxmanual.com>

<http://aubethermostatmanual.com>

Golf course search by state

<http://golfingnear.com>

Email search by domain

<http://emailbydomain.com>

Auto manuals search

<http://auto.somanuals.com>

TV manuals search

<http://tv.somanuals.com>