

DENON

AV SURROUND RECEIVER

AVR-5800

OPERATING INSTRUCTIONS

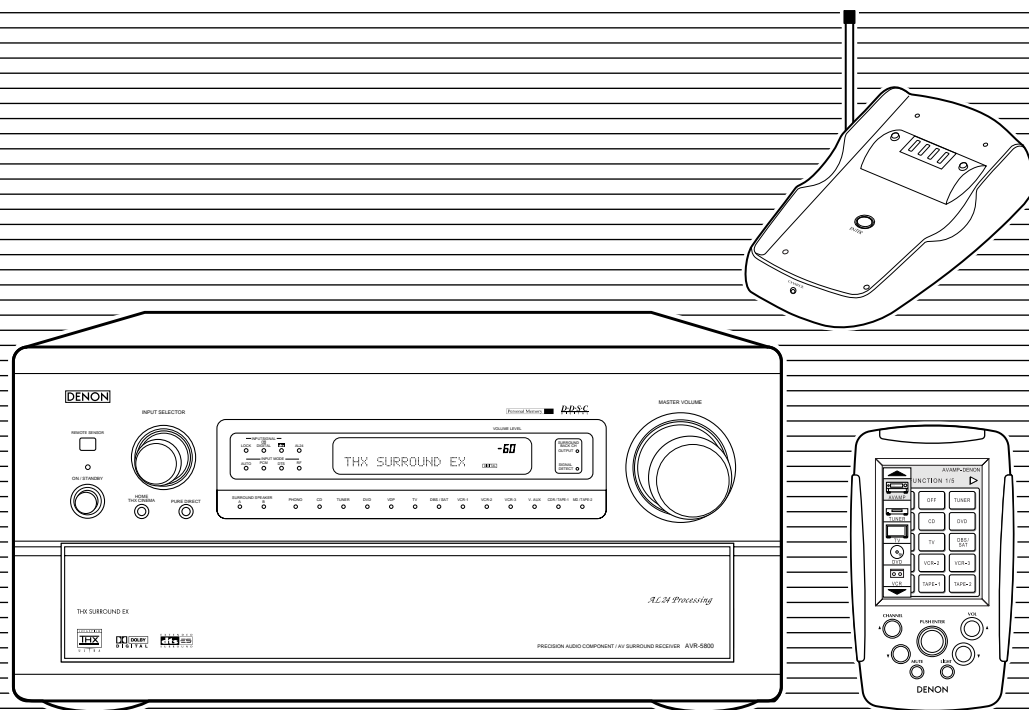

- We greatly appreciate your purchase of the AVR-5800.
- To be sure you take maximum advantage of all the features the AVR-5800 has to offer, read these instructions carefully and use the set properly. Be sure to keep this manual for future reference should any questions or problems arise.

"SERIAL NO. _____"

PLEASE RECORD UNIT SERIAL NUMBER ATTACHED TO THE REAR OF THE CABINET FOR FUTURE REFERENCE"

SAFETY PRECAUTIONS



CAUTION
RISK OF ELECTRIC SHOCK
DO NOT OPEN



CAUTION: TO REDUCE THE RISK OF ELECTRIC SHOCK, DO NOT REMOVE COVER (OR BACK). NO USER-SERVICEABLE PARTS INSIDE. REFER SERVICING TO QUALIFIED SERVICE PERSONNEL.



The lightning flash with arrowhead symbol, within an equilateral triangle, is intended to alert the user to the presence of uninsulated "dangerous voltage" within the product's enclosure that may be of sufficient magnitude to constitute a risk of electric shock to persons.



The exclamation point within an equilateral triangle is intended to alert the user to the presence of important operating and maintenance (servicing) instructions in the literature accompanying the appliance.

WARNING: TO REDUCE THE RISK OF FIRE OR ELECTRIC SHOCK, DO NOT EXPOSE THIS APPLIANCE TO RAIN OR MOISTURE.

CAUTION

TO PREVENT ELECTRIC SHOCK, MATCH WIDE BLADE OF PLUG TO WIDE SLOT, FULLY INSERT.

ATTENTION

POUR ÉVITER LES CHOCS ÉLECTRIQUES, INTEROUDIRE LA LAME LA PLUS LARGE DE LA FICHE DANS LA BORNE CORRESPONDANTE DE LA PRISE ET POUSSER JUSQU' AU FOND.

This device complies with Part 15 of the FCC Rules. Operation is subject to the following two conditions: (1) This device may not cause harmful interference, and (2) this device must accept any interference received, including interference that may cause undesired operation.

This Class B digital apparatus meets all requirements of the Canadian Interference-Causing Equipment Regulations.

Cet appareil numérique de la classe B respecte toutes les exigences du Règlement sur le matériel brouilleur du Canada.

NOTE ON USE / OBSERVATIONS RELATIVES A L'UTILISATION

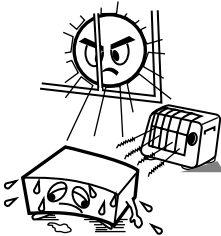

- Avoid high temperatures. Allow for sufficient heat dispersion when installed on a rack.
- Éviter des températures élevées. Tenir compte d'une dispersion de chaleur suffisante lors de l'installation sur une étagère.

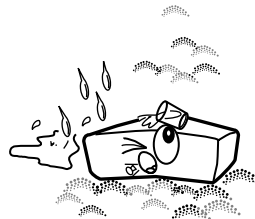

- Keep the set free from moisture, water, and dust.
- Protéger l'appareil contre l'humidité, l'eau et la poussière.

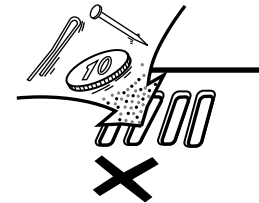

- Do not let foreign objects in the set.
- Ne pas laisser des objets étrangers dans l'appareil.

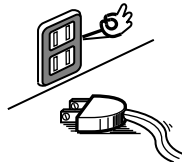

- Unplug the power cord when not using the set for long periods of time.
- Débrancher le cordon d'alimentation lorsque l'appareil n'est pas utilisé pendant de longues périodes.

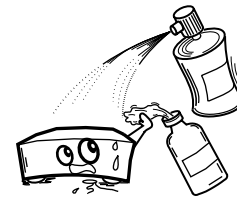

- Do not let insecticides, benzene, and thinner come in contact with the set.
- Ne pas mettre en contact des insecticides, du benzène et un diluant avec l'appareil.

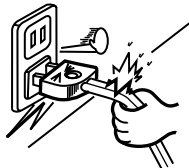

- Handle the power cord carefully. Hold the plug when unplugging the cord.
- Manipuler le cordon d'alimentation avec précaution. Tenir la prise lors du débranchement du cordon.

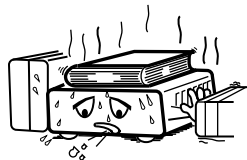

*(For sets with ventilation holes)

- Do not obstruct the ventilation holes.
- Ne pas obstruer les trous d'aération.

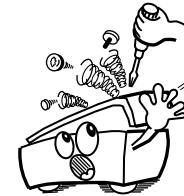

- Never disassemble or modify the set in any way.
- Ne jamais démonter ou modifier l'appareil d'une manière ou d'une autre.

SAFETY INSTRUCTIONS

1. Read Instructions – All the safety and operating instructions should be read before the appliance is operated.
2. Retain Instructions – The safety and operating instructions should be retained for future reference.
3. Heed Warnings – All warnings on the appliance and in the operating instructions should be adhered to.
4. Follow Instructions – All operating and use instructions should be followed.
5. Water and Moisture – The appliance should not be used near water – for example, near a bathtub, washbowl, kitchen sink, laundry tub, in a wet basement, or near a swimming pool, and the like.
6. Carts and Stands – The appliance should be used only with a cart or stand that is recommended by the manufacturer.
- 6A. An appliance and cart combination should be moved with care. Quick stops, excessive force, and uneven surfaces may cause the appliance and cart combination to overturn.
7. Wall or Ceiling Mounting – The appliance should be mounted to a wall or ceiling only as recommended by the manufacturer.
8. Ventilation – The appliance should be situated so that its location or position does not interfere with its proper ventilation. For example, the appliance should not be situated on a bed, sofa, rug, or similar surface that may block the ventilation openings; or, placed in a built-in installation, such as a bookcase or cabinet that may impede the flow of air through the ventilation openings.
9. Heat – The appliance should be situated away from heat sources such as radiators, heat registers, stoves, or other appliances (including amplifiers) that produce heat.
10. Power Sources – The appliance should be connected to a power supply only of the type described in the operating instructions or as marked on the appliance.
11. Grounding or Polarization – Precautions should be taken so that the grounding or polarization means of an appliance is not defeated.
12. Power-Cord Protection – Power-supply cords should be routed so that they are not likely to be walked on or pinched by items placed upon or against them, paying particular attention to cords at plugs, convenience receptacles, and the point where they exit from the appliance.
14. Cleaning – The appliance should be cleaned only as recommended by the manufacturer.
15. Power Lines – An outdoor antenna should be located away from power lines.
16. Outdoor Antenna Grounding – If an outside antenna is connected to the receiver, be sure the antenna system is grounded so as to provide some protection against voltage surges and built-up static charges. Article 810 of the National Electrical Code, ANSI/NFPA 70, provides information with regard to proper grounding of the mast and supporting structure, grounding of the lead-in wire to an antenna-discharge unit, size of grounding conductors, location of antenna-discharge unit, connection to grounding electrodes, and requirements for the grounding electrode. See Figure A.
17. Nonuse Periods – The power cord of the appliance should be unplugged from the outlet when left unused for a long period of time.
18. Object and Liquid Entry – Care should be taken so that objects do not fall and liquids are not spilled into the enclosure through openings.
19. Damage Requiring Service – The appliance should be serviced by qualified service personnel when:
 - A. The power-supply cord or the plug has been damaged; or
 - B. Objects have fallen, or liquid has been spilled into the appliance; or
 - C. The appliance has been exposed to rain; or
 - D. The appliance does not appear to operate normally or exhibits a marked change in performance; or
 - E. The appliance has been dropped, or the enclosure damaged.
20. Servicing – The user should not attempt to service the appliance beyond that described in the operating instructions. All other servicing should be referred to qualified service personnel.

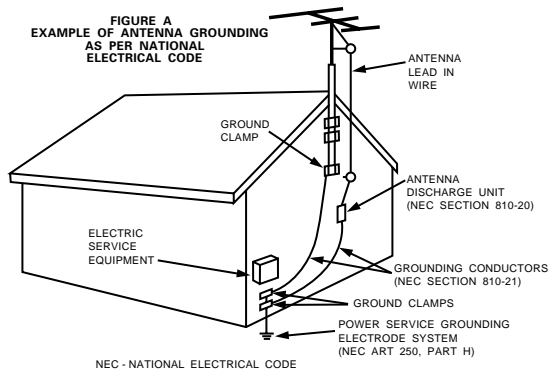

■ INTRODUCTION

Thank you for choosing the DENON AVR-5800 Digital Surround A / V receiver. This remarkable component has been engineered to provide superb surround sound listening with home theater sources such as DVD, as well as providing outstanding high fidelity reproduction of your favorite music sources.

As this product is provided with an immense array of features, we recommend that before you begin hookup and operation that you review the contents of this manual before proceeding.

TABLE OF CONTENTS

1 Before Using	4	10 Surround.....	42~47
2 Cautions on Installation	4	11 DENON Original Surround Modes	48~51
3 Cautions on Handling	5	12 Listening to the Radio	52~54
4 Features.....	5	13 Last Function Memory	54
5 Connections	6~13	14 Initialization of the Microprocessor.....	54
6 Part Names and Functions	14, 15	15 Troubleshooting.....	55
7 Setting up the system	16~30	16 Additional Information	56~65
8 Remote Control Unit	31	17 Specifications	66
9 Operation	32~41		

■ ACCESSORIES

Check that the following parts are included in addition to the main unit:

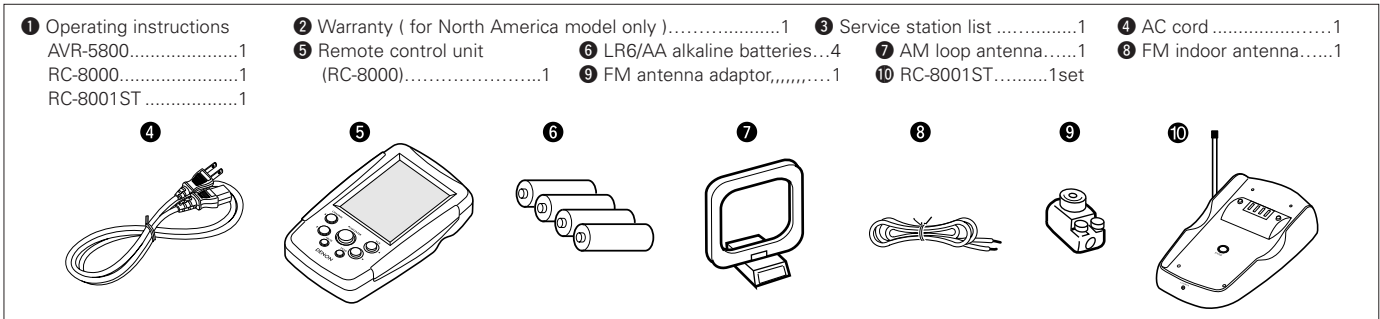

1 BEFORE USING

Pay attention to the following before using this unit:

- **Moving the set**
To prevent short circuits or damaged wires in the connection cords, always unplug the power cord and disconnect the connection cords between all other audio components when moving the set.
- **Before turning the power switch on**
Check once again that all connections are proper and that there are not problems with the connection cords. Always set the power switch to the standby position before connecting and disconnecting connection cords.

- **Store this instructions in a safe place.**
After reading, store this instructions along with the warranty in a safe place.
- **Note that the illustrations in this instructions may differ from the actual set for explanation purposes.**

2 CAUTIONS ON INSTALLATION

Noise or disturbance of the picture may be generated if this unit or any other electronic equipment using microprocessors is used near a tuner or TV.

If this happens, take the following steps:

- Install this unit as far as possible from the tuner or TV.
- Set the antenna wires from the tuner or TV away from this unit's power cord and input/output connection cords.
- Noise or disturbance tends to occur particularly when using indoor antennas or 300 Ω/ohms feeder wires. **We recommend using outdoor antennas and 75 Ω/ohms coaxial cables.**

For heat dispersal, leave at least 10 cm of space between the top, back and sides of this unit and the wall or other components.

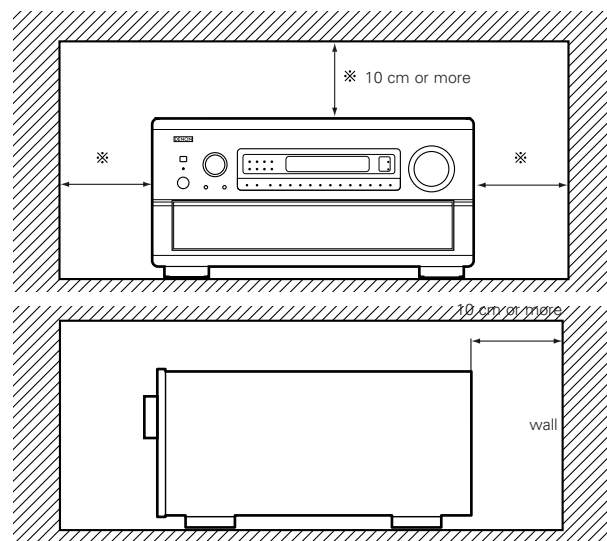

3 CAUTIONS ON HANDLING

- **Switching the input function when input jacks are not connected**

A clicking noise may be produced if the input function is switched when nothing is connected to the input jacks. If this happens, either turn down the MASTER VOLUME control or connect components to the input jacks.

- **Muting of PRE OUT jacks and SPEAKER terminals**

The PRE OUT jacks and SPEAKER terminals include a muting circuit. Because of this, the output signals are greatly reduced for several seconds after the power switch is turned on or input function, surround mode or any other-set-up is changed. If the volume is turned up during this time, the output will be very high after the muting circuit stops functioning. Always wait until the muting circuit turns off before adjusting the volume.

- **Whenever the power switch is in the STANDBY state, the apparatus is still connected on AC line voltage. Please be sure to unplug the cord when you leave home for, say, a vacation.**

4 FEATURES

1. Digital Surround Sound Decoding

Featuring dual 32 bit high speed DSP processors, operating entirely in digital domain, surround sound from digital sources such as DVD, DTV and satellite are faithfully re-created.

2. Dolby Digital

Using advanced digital processing algorithms, Dolby Digital provides up to 5.1 channels of wide-range, high fidelity surround sound. Dolby Digital is the default digital audio delivery system for North American DVD and DTV, and is available on laser discs as well as some digital satellite direct-to-home services.

3. DTS (Digital Theater Systems)

DTS provides up to 5.1 channels of wide-range, high fidelity surround sound, from sources such as laser disc, DVD and specially-encoded music discs.

4. Lucasfilm Home THX Ultra Certified

Home THX is the unique collaboration between Lucasfilm Ltd. and audio equipment manufacturers. THX Ultra certification is the highest performance level, and provides a rigorous set of performance standards, along with proprietary surround sound post-processing technologies, designed to enhance the surround soundtrack playback experience in the home theater.

5. THX Surround EX

The AVR-5800 is fully compatible with THX Surround EX, the latest surround format.

6. DTS-ES Extended Surround and DTS Neo:6

The AVR-5800 is compatible with DTS-ES Extended Surround, a new multi-channel format developed by Digital Theater Systems Inc. The AVR-5800 is also compatible with DTS Neo:6, a surround mode allowing 6.1-channel playback of regular stereo sources.

7. Wide screen mode for a 7.1-channel sound even with 5.1-channel sources

DENON has developed a wide screen mode with a new design which recreates the effects of the multi surround speakers in movie theaters. The result is 7.1-channel sound taking full advantage of surround back speakers, even with Dolby Pro Logic or Dolby Digital/DTS 5.1-channel signals.

8. 24 bit D/A Conversion

All eight channels, including the seven main channels and the low frequency effects (LFE) channel benefit from reference ANALOG DEVICES DACs, for optimum high fidelity reproduction of music and movie soundtracks.

9. Dual Surround Speaker Mode

Provides for the first time the ability to optimize surround sound reproduction using two different types of surround sound speakers as well as two different surround speaker positions:

(1) Movie Surround

Motion picture soundtracks use the surround channel(s) to provide the ambient elements of the acoustic environment they want the audience to realize. This is best accomplished by the use of specially-designed surround speakers that offer a wide diffusion pattern (bipolar dispersion) or by using surround speakers that provide broad dispersion with a minimum of on-axis localization (dipolar dispersion). Side wall mounting (closer

to the ceiling) of the surround speakers provides the greatest envelopment, minimizing localization of direct sound from the speakers.

(2) Music Surround

With full range discrete surround channels, as well as three discrete full range front channels, digital formats such as Dolby and DTS offer thrilling surround sound music listening. Producers of multi-channel discrete digital music recordings almost always favor the use of direct radiating (monopolar) surround speakers, placed in the rear corners of the room, since that is how they configure their studios during the mixing/creation process.

The DENON AVR-5800 provides the ability to connect two different sets of surround speakers, and place them in the appropriate locations in your home theater room, so that you can enjoy both movie soundtracks and music listening, with optimum results and no compromise.

10. Multi-zone control

The AVR-5800 is equipped with two sets of multi-zone outputs allowing a source other than the one currently being played to be selected.

(1) Multi-zone 1

These are level adjustable pre-outputs. (A fixed output level can also be selected.)

The video signals of the input source selected with the multi-zone 1 selector are output.

(2) Multi-zone 2

When set at the System Setup Menu, the power amplifier for the surround back channel can be used as the multi-zone 2 power amplifier and speakers can be connected to the multi-zone 2 speaker terminals for playback.

11. Component Video Switching

In addition to composite video and "S" video switching, the AVR-5800 provides 3 sets of component video (Y, R-Y, B-Y) inputs for the DVD, TV and DBS/SAT inputs, and one set of component video outputs to the television, for superior picture quality.

12. Video Select Function

Allow you to watch one source (visual) while listening to another source (audio).

13. Seven Identical Power Amplifiers

Featuring discrete high current power transistors, the power amp section is THX Ultra certified for top performance with the widest range of speaker systems. Rated at 170 watts into 8 Ω /ohms, the amp channels feature additional low impedance drive capability.

14. Future Sound Format Upgrade Capability via Eight Channel Inputs & Outputs

For future multi-channel audio format(s), the AVR-5800 is provided with 7.1 channel (seven main channels, plus one low frequency effects channel) inputs, along with a full set of 7.1 channel pre-amp outputs, controlled by the 8 channel master volume control. This assures future upgrade possibilities for any future multi-channel sound format.

5 CONNECTIONS

- Do not plug in the AC cord until all connections have been completed.
- Be sure to connect the left and right channels properly (left with left, right with right).
- Insert the plugs securely. Incomplete connections will result in the generation of noise.
- Use the **AC OUTLETS** for audio equipment only. Do not use them for hair driers, etc.

- Note that binding pin plug cords together with AC cords or placing them near a power transformer will result in generating hum or other noise.
- Noise or humming may be generated if a connected audio equipment is used independently without turning the power of this unit on. If this happens, turn on the power of the this unit.

Connecting the audio components

- When making connections, also refer to the operating instructions of the other components.

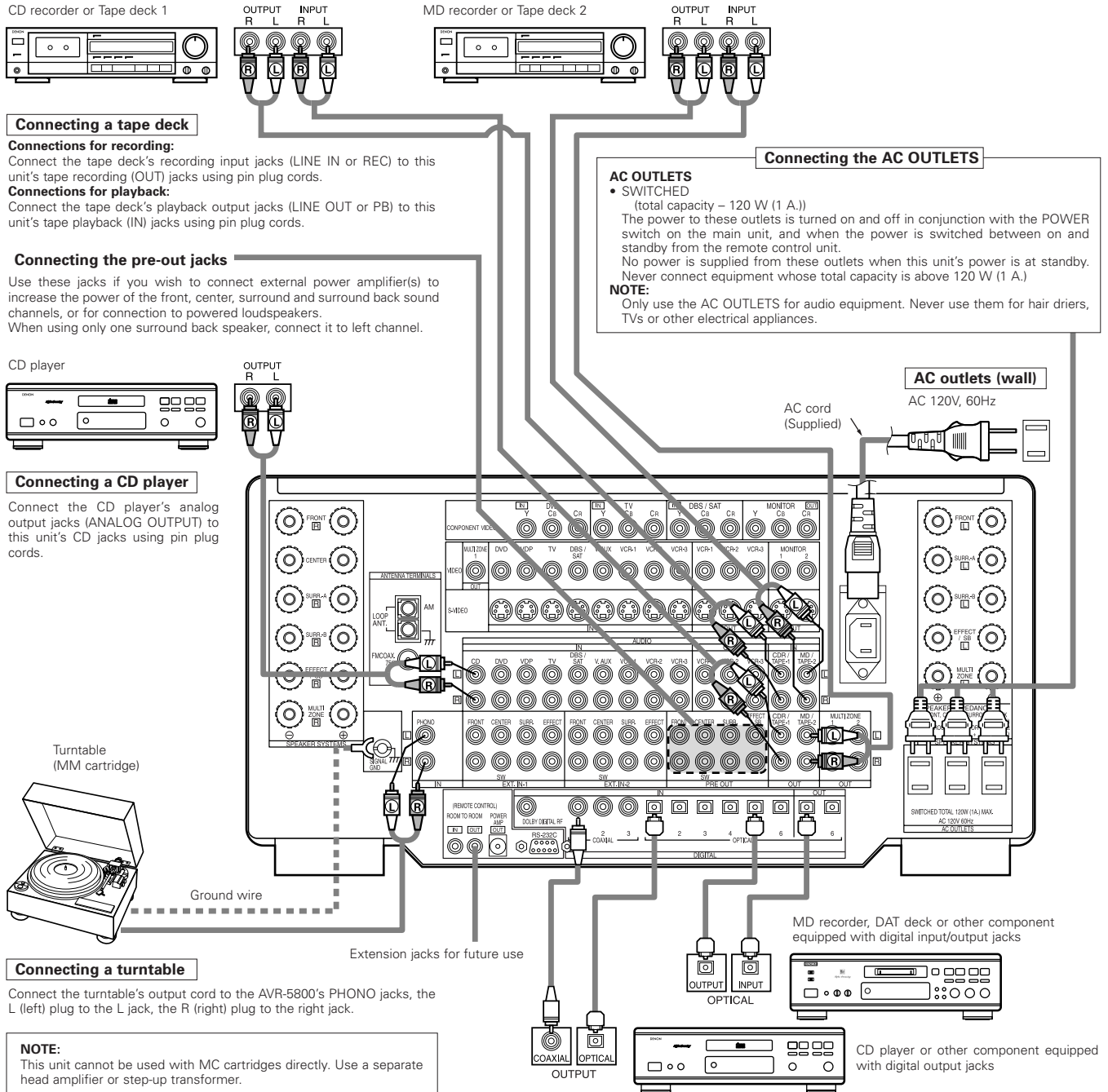

Connecting video components

- To connect the video signal, connect using a 75 Ω/ohms video signal cable cord. Using an improper cable can result in a drop in picture quality.
- When making connections, also refer to the operating instructions of the other components.

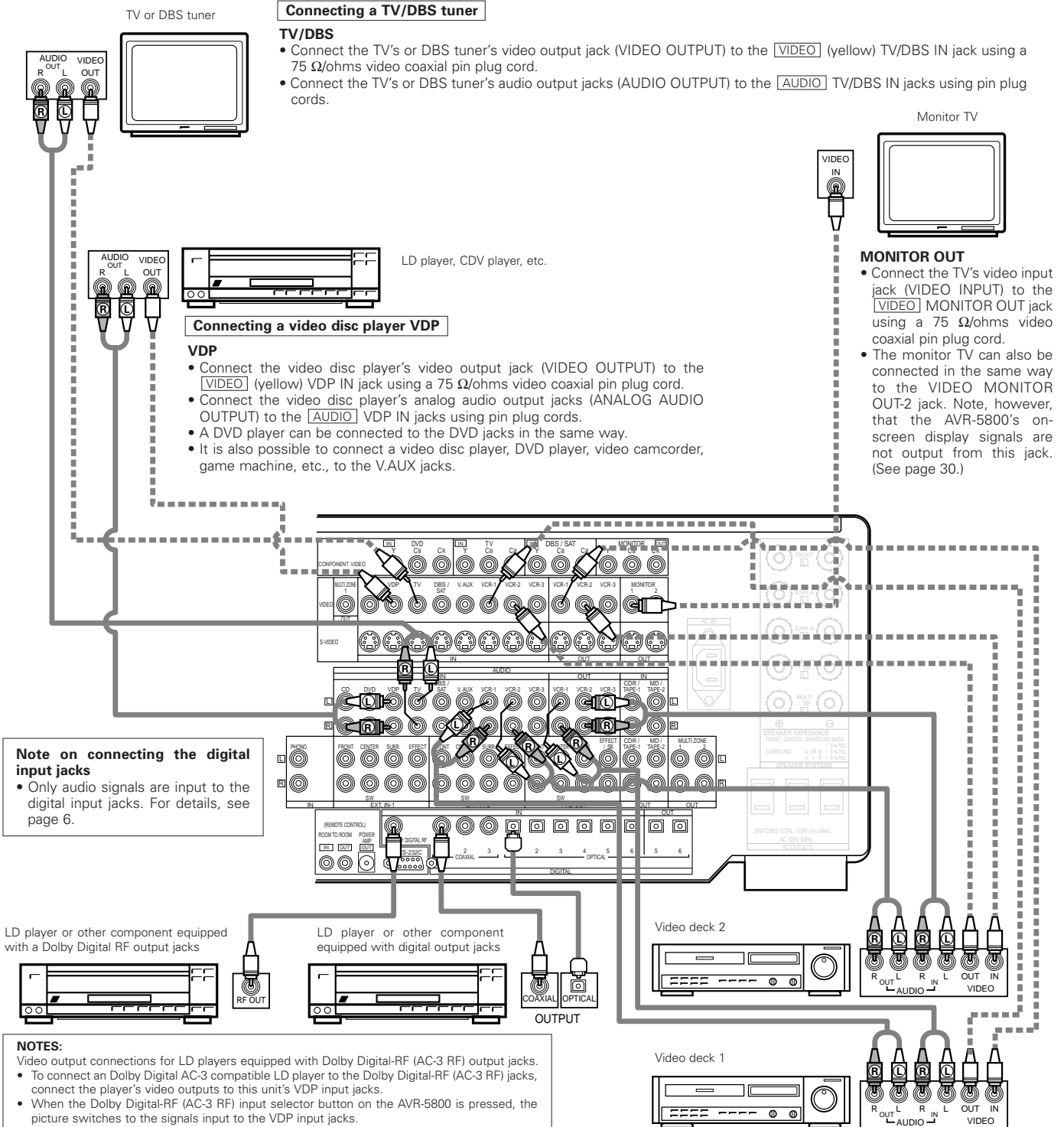

Connecting a video decks

- There are three sets of video deck (VCR) jacks, so three video decks can be connected for simultaneous recording or video copying.

Video input/output connections:

- Connect the video deck's video output jack (VIDEO OUT) to the VIDEO (yellow) VCR-1 IN jack, and the video deck's video input jack (VIDEO IN) to the VIDEO (yellow) VCR-1 OUT jack using 75 Ω/ohms video coaxial pin plug cords.

Connecting the audio output jacks

- Connect the video deck's audio output jacks (AUDIO OUT) to the AUDIO VCR-1 IN jacks, and the video deck's audio input jacks (AUDIO IN) to the AUDIO VCR-1 OUT jacks using pin plug cords.
- ※ Connect the another video deck to the VCR-2 or VCR-3 jacks in the same way.

Connecting a video component equipped with S-Video jacks

- When making connections, also refer to the operating instructions of the other components.

- **A note on the S input jacks**

The input selectors for the S inputs and pin jack inputs work in conjunction with each other.

- **Precaution when using S-jacks**

This unit's S-jacks (input and output) and video pin jacks (input and output) have independent circuit structures, so that video signals input from the S-jacks are only output from the S-jack outputs and video signals input from the pin jacks are only output from the pin jack outputs.

When connecting this unit with equipment that is equipped with S-jacks, keep the above point in mind and make connections according to the equipment's instruction manuals.

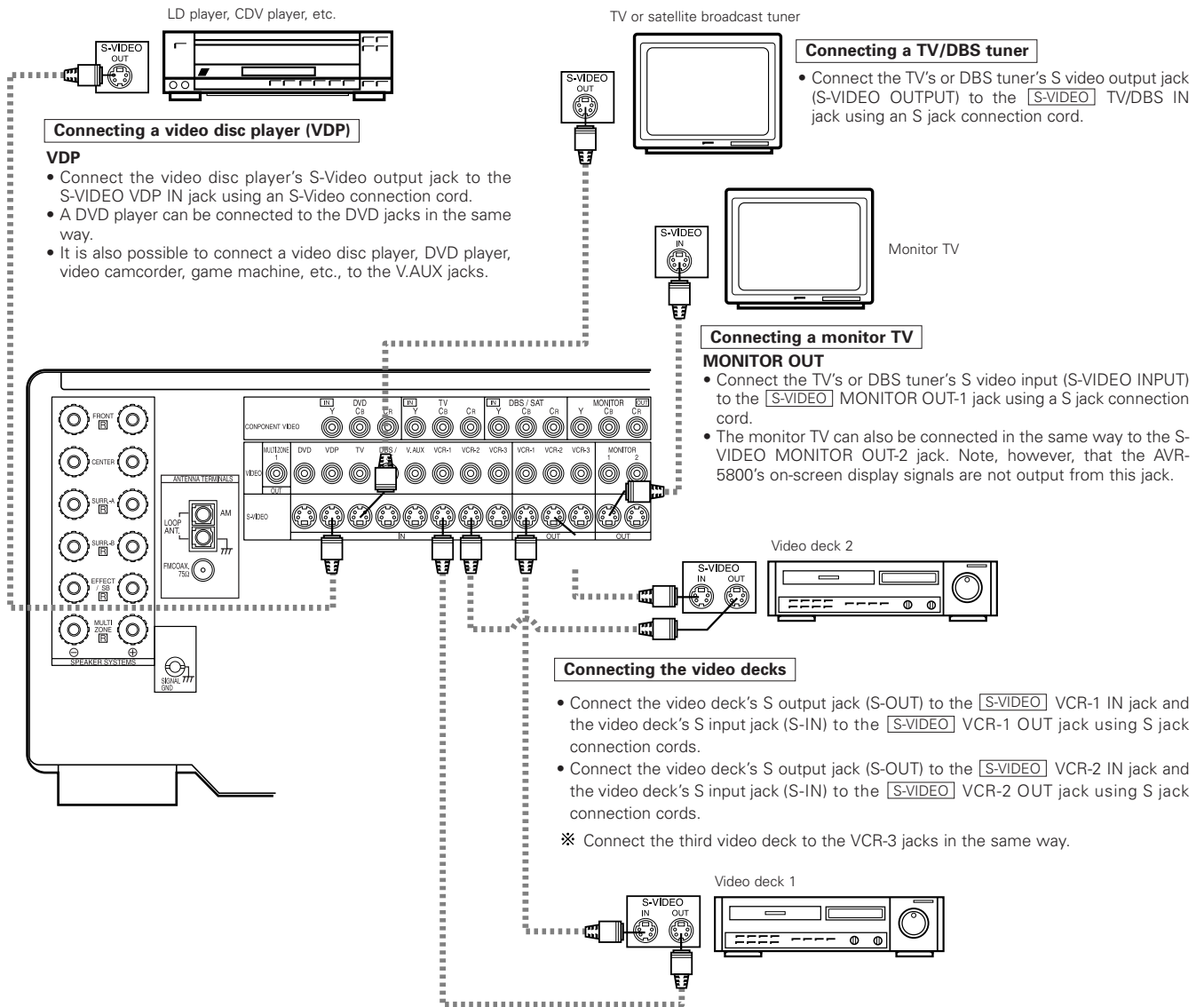

Connect the components' audio inputs and outputs as described on page 6.

NOTE:

- The on-screen display signals are not output from the video signal MONITOR OUT-2 (yellow) or S-Video signal MONITOR OUT-2 jack.
- The MONITOR OUT-2 output switches together with the input function selected with the REC/M-ZONE 2 button. To use as the monitor output, set "SOURCE" as the REC/M-ZONE 2 input function.

Connecting a Video Component Equipped with Color Difference (Component - Y, R-Y, B-Y) Video Jacks (DVD Player)

- When making connections, also refer to the operating instructions of the other components.
- The signals input to the color difference (component) video jacks are not output from the VIDEO output jack (yellow) or the S-Video output jack. In addition, the video signals input to the VIDEO input (yellow) and S-Video input jacks are not output to the color difference (component) video jacks.
- The AVR-5800's on-screen display signals are not output from the color difference (component) video output jacks (MONITOR OUT).
- Some video sources with component video outputs are labeled Y, Pb, Pr, or Y, Cb, Cr, or Y, R-Y, B-Y. These terms all refer to component video color difference output.

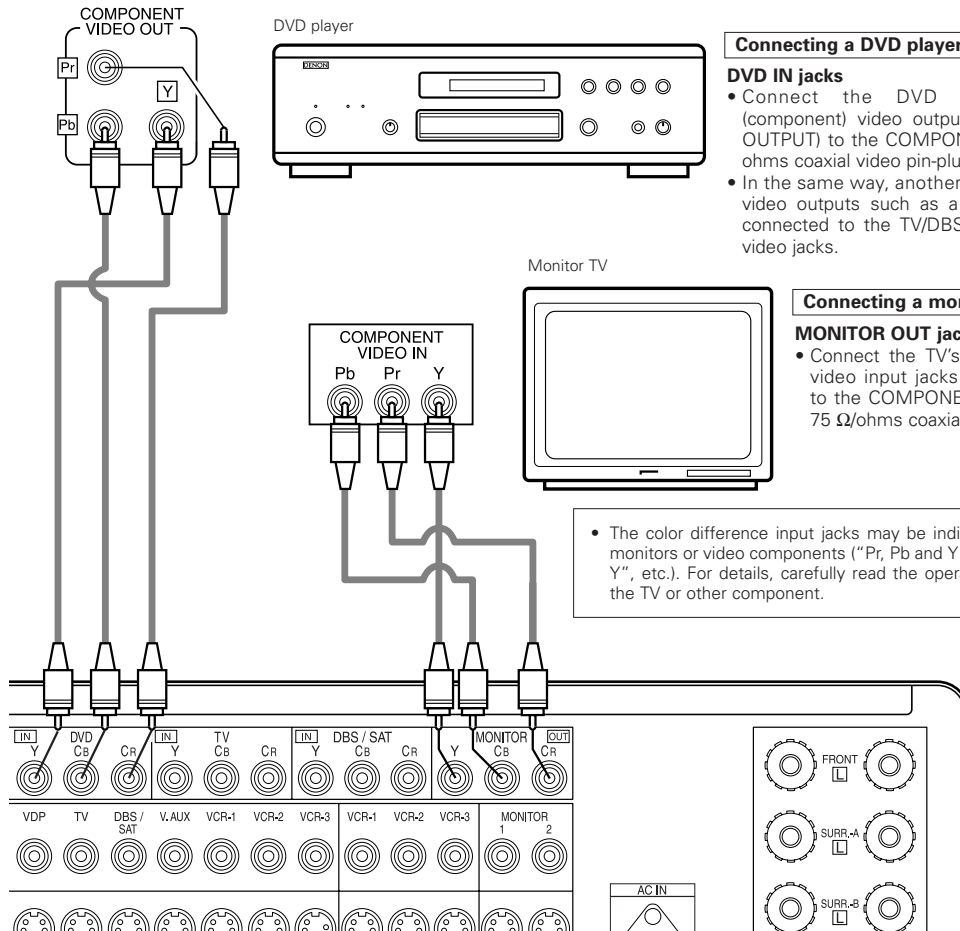

Connecting the antenna terminals

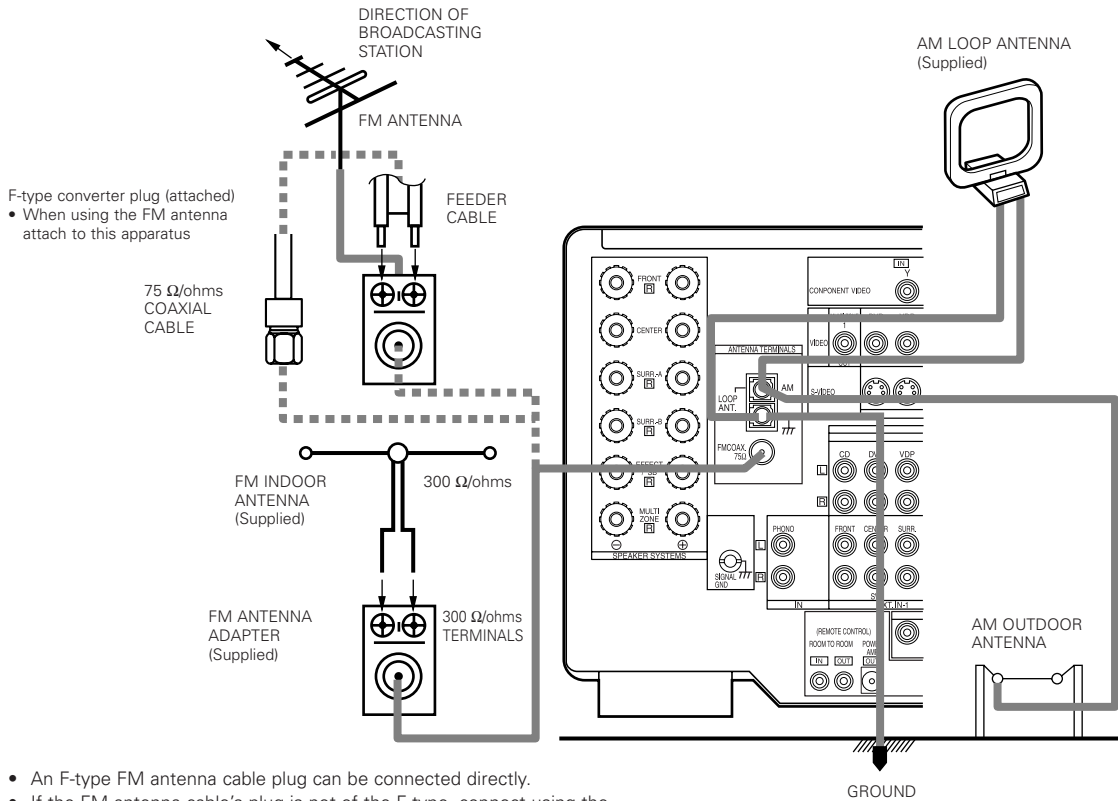

- An F-type FM antenna cable plug can be connected directly.
- If the FM antenna cable's plug is not of the F-type, connect using the included antenna adapter.

AM loop antenna assembly

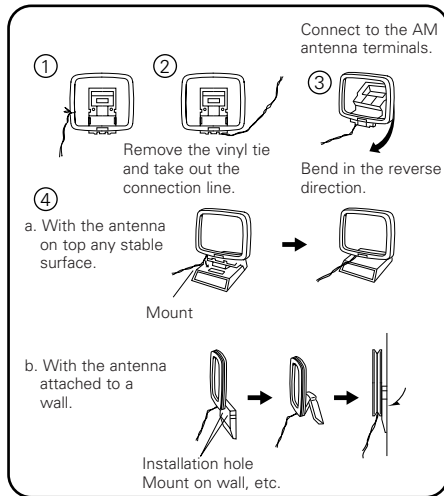

FM antenna adapter assembly

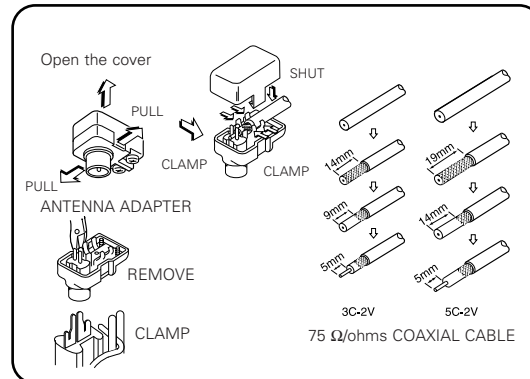

Connection of AM antennas

1. Loosen by turning counterclockwise.
2. Insert the cord.
3. Tighten by turning clockwise.

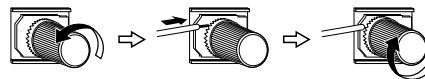

Note to CATV system installer:

This reminder is provided to call the CATV system installer's attention to Article 820-40 of the NEC which provides guidelines for proper grounding and, in particular, specifies that the cable ground shall be connected to the grounding system of the building, as close to the point of cable entry as practical.

Notes:

- Do not connect two FM antennas simultaneously.
- Even if an external AM antenna is used, do not disconnect the AM loop antenna.
- Make sure AM loop antenna lead terminals do not touch metal parts of the panel.

Connecting the external input (EXT. IN) jacks

- These jacks are for inputting multi-channel audio signals from an outboard decoder, or a component with a different type of multi-channel decoder, such as a Super Audio DVD player, or a multi-channel SACD player, or other future multi-channel sound format decoder.
- When making connections, also refer to the operating instructions of the other components.

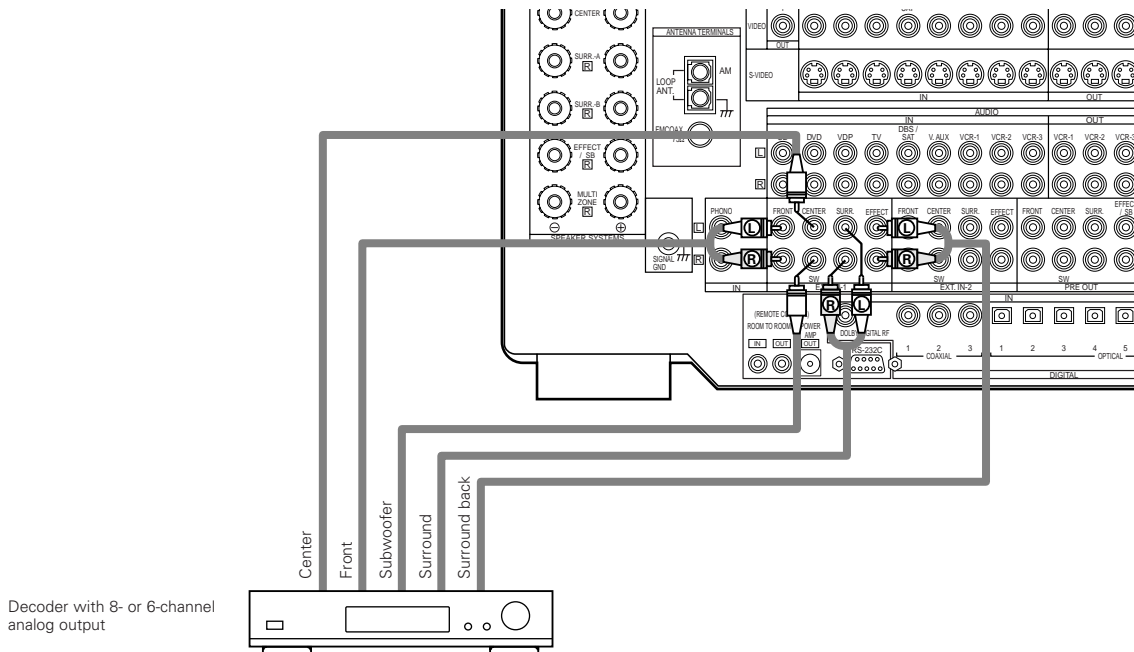

※ For instructions on playback using the external input (EXT. IN) jacks, see page 38.

Connecting the MULTI SOURCE jacks

- If another pre-main (integrated) amplifier is connected, the multi-source jacks can be used to play a different program source in another room at the same time. (See page 37.)

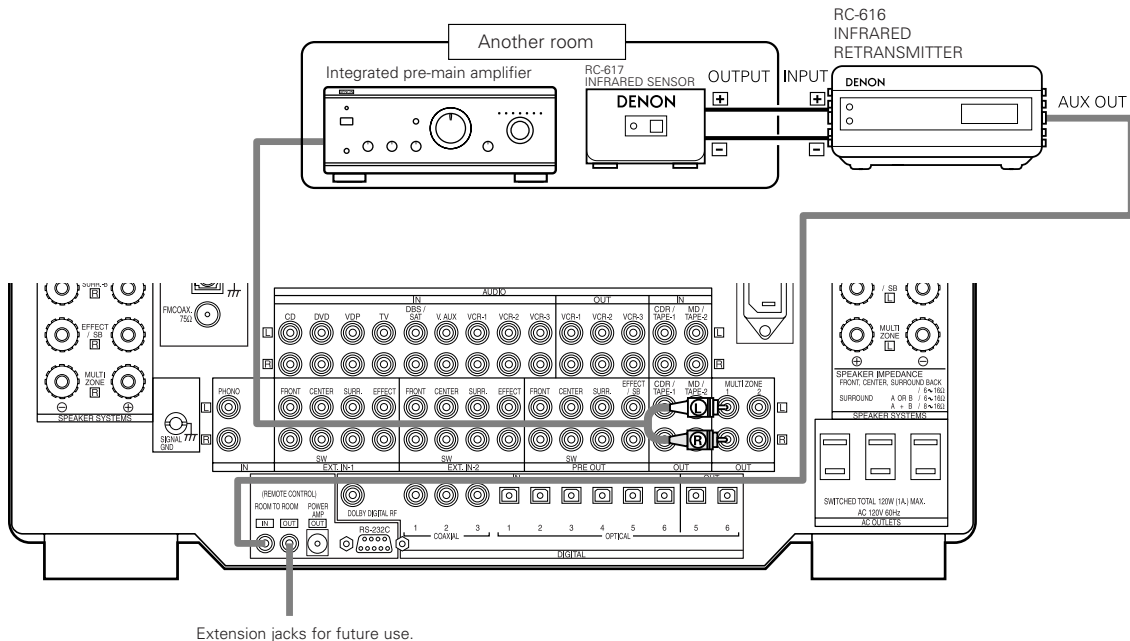

※ For instructions on operations using the MULTI SOURCE jacks, see page 37.

Speaker system connections

- Connect the speaker terminals with the speakers making sure that like polarities are matched (⊕ with ⊕, ⊖ with ⊖). Mismatching of polarities will result in weak central sound, unclear orientation of the various instruments, and the sense of direction of the stereo being impaired.
- When making connections, take care that none of the individual conductors of the speaker cord come in contact with adjacent terminals, with other speaker cord conductors, or with the rear panel.

NOTE:

NEVER touch the speaker terminals when the power is on.
Doing so could result in electric shocks.

Speaker Impedance

- Speakers with an impedance of from 6 to 16 Ω /ohms can be connected for use as front and center speakers.
- Speakers with an impedance of 6 to 16 Ω /ohms can be connected for use as surround speakers.
- The protector circuit may be activated if the set is played for long periods of time at high volumes when speakers with an impedance lower than the specified impedance are connected.

Connecting the speaker cords

1. Loosen by turning counterclockwise.

2. Insert the cord.

3. Tighten by turning clockwise.

Either tightly twist or terminate the core wires.

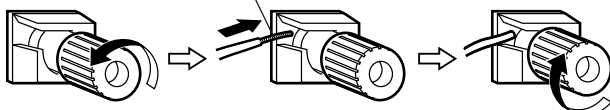

Connecting banana plugs

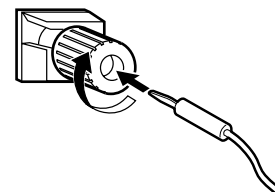

Turn clockwise to tighten, then insert the banana plug.

Protector circuit

- This unit is equipped with a high-speed protection circuit. The purpose of this circuit is to protect the speakers under circumstances such as when the output of the power amplifier is inadvertently short-circuited and a large current flows, when the temperature surrounding the unit becomes unusually high, or when the unit is used at high output over a long period which results in an extreme temperature rise.

When the protection circuit is activated, the speaker output is cut off and the power supply indicator LED flashes. Should this occur, please follow these steps: be sure to switch off the power of this unit, check whether there are any faults with the wiring of the speaker cables or input cables, and wait for the unit to cool down if it is very hot. Improve the ventilation condition around the unit and switch the power back on.

If the protection circuit is activated again even though there are no problems with the wiring or the ventilation around the unit, switch off the power and contact a DENON service center.

Note on speaker impedance

- The protector circuit may be activated if the set is played for long periods of time at high volumes when speakers with an impedance lower than the specified impedance (for example speakers with an impedance of lower than 4 Ω /ohms) are connected. If the protector circuit is activated, the speaker output is cut off. Turn off the set's power, wait for the set to cool down, improve the ventilation around the set, then turn the power back on.

Cooling fan

- The AVR-5800 is equipped with a cooling fan to prevent the temperature inside the set from rising. The fan is activated under certain usage conditions. It is temperature and volume level sensitive, to minimize or prevent audible fan noise.

Connections

- When making connections, also refer to the operating instructions of the other components.

Connection jack for subwoofer with built-in amplifier (super woofer), etc.

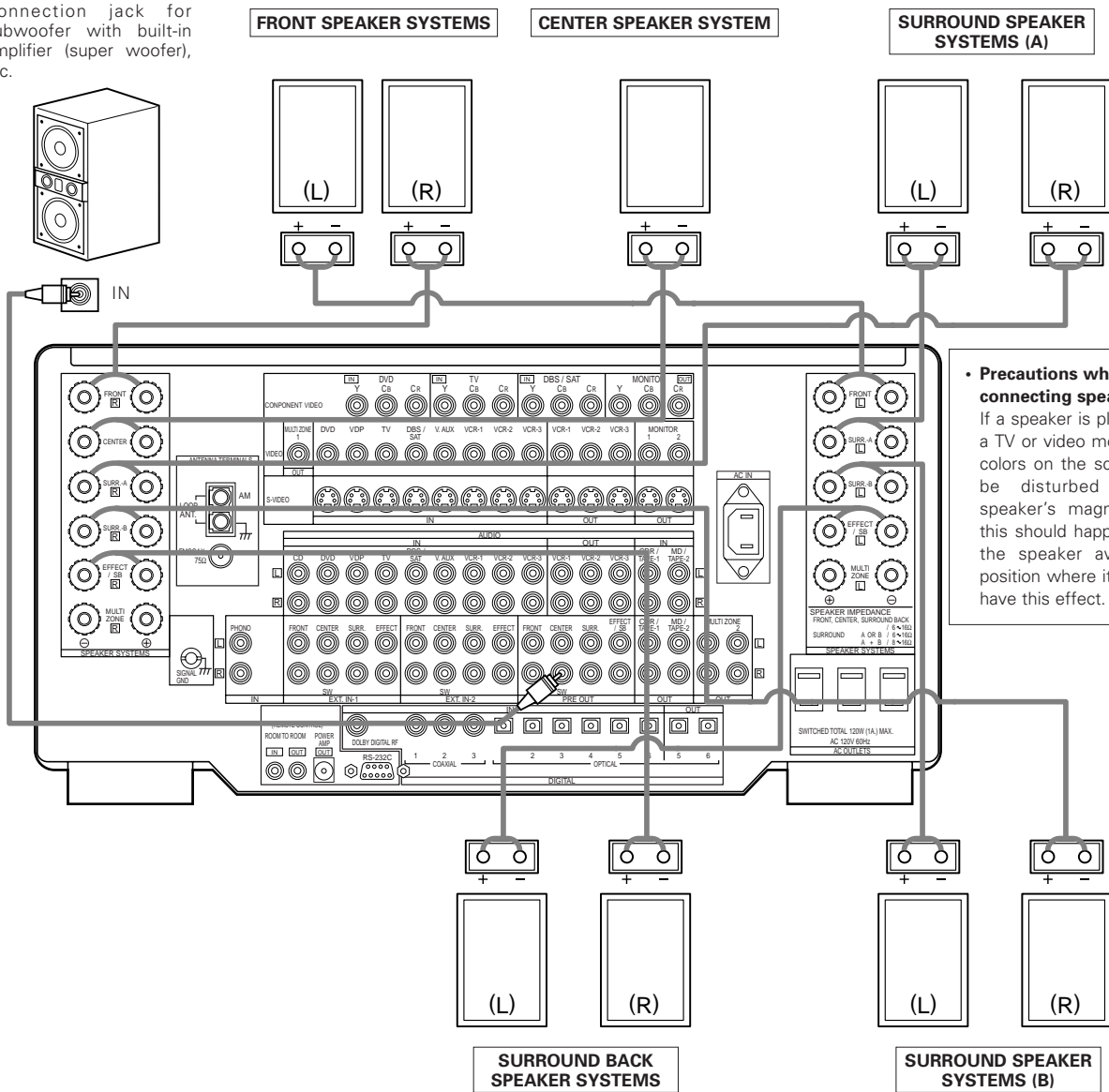

• Precautions when connecting speakers
 If a speaker is placed near a TV or video monitor, the colors on the screen may be disturbed by the speaker's magnetism. If this should happen, move the speaker away to a position where it does not have this effect.

NOTE:
 When using only one surround back speaker, connect it to left channel.

6 PART NAMES AND FUNCTIONS

Front Panel

- For details on the functions of these parts, refer to the pages given in parentheses ().

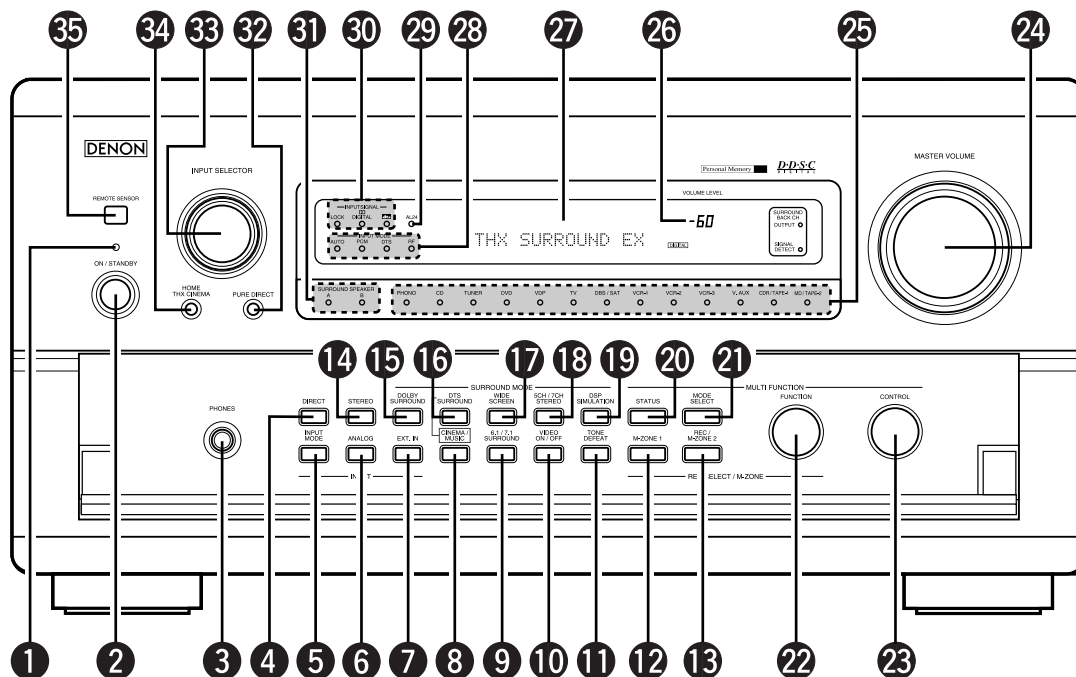

- | | |
|--|---|
| 1 Power indicator.....(32) | 19 DSP SIMULATION button(49) |
| 2 Power switch.....(32) | 20 MULTI FUNCTION STATUS button.....(35) |
| 3 Headphones jack (PHONES).....(35) | 21 MULTI FUNCTION MODE SELECT button(42) |
| 4 DIRECT button.....(44) | 22 MULTI FUNCTION, REC/SELECTOR M-ZONE selector dial (FUNCTION)(36) |
| 5 INPUT MODE selector button(33) | 23 MULTI FUNCTION control dial (CONTROL)(43) |
| 6 ANALOG button.....(33) | 24 MASTER VOLUME control.....(34) |
| 7 EXT. IN button.....(33) | 25 Input source indicators(33) |
| 8 CINEMA/MUSIC button.....(47) | 26 Master volume indicator (VOLUME LEVEL).....(34) |
| 9 6.1/7.1 SURROUND button(51) | 27 Display |
| 10 VIDEO ON/OFF button(39) | 28 Input mode indicators (INPUT MODE)(34) |
| 11 TONE DEFEAT button(35) | 29 AL24 indicator.....(34) |
| 12 M-ZONE 1 button(37) | 30 Digital signal indicators (SIGNAL)(34) |
| 13 REC/M-ZONE-2 button(36) | 31 Surround speaker system indicators (SURROUND SPEAKER A/B)).....(35) |
| 14 STEREO button.....(44) | 32 PURE DIRECT button(44) |
| 15 DOLBY SURROUND button(46) | 33 Input source selector dial (INPUT SELECTOR).....(33) |
| 16 DTS SURROUND button(46) | 34 HOME THX CINEMA button(45) |
| 17 WIDE SCREEN button.....(49) | 35 Remote control sensor (REMOTE SENSOR)(31) |
| 18 5CH/7CH STEREO button(49) | |

Remote control unit

- For details, refer to the separate (supplied) RC-8000 operating instructions.

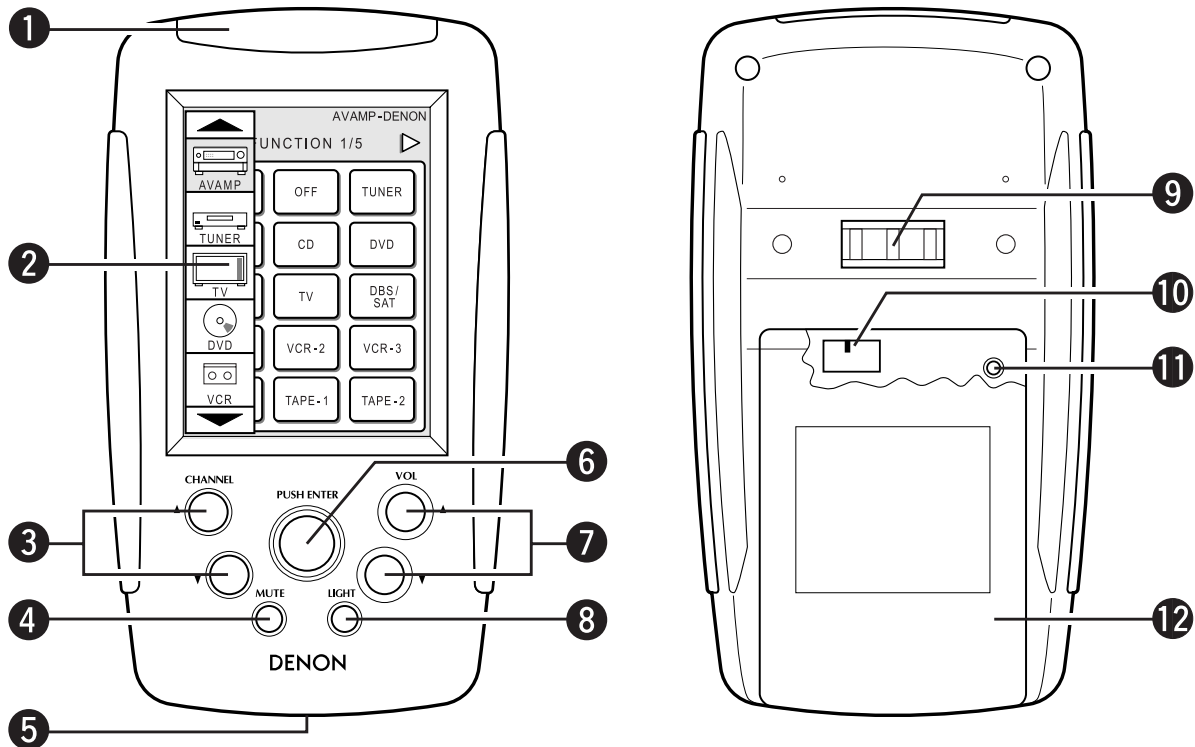

- | | |
|---------------------------|---------------------------------|
| 1 Transmitter | 7 VOL. (volume) up/down buttons |
| 2 Touch panel | 8 LIGHT (back light) button |
| 3 CHANNEL up/down buttons | 9 Battery charging contacts |
| 4 MUTE button | 10 RF frequency selector switch |
| 5 USB terminal | 11 Reset button |
| 6 Jog stick (PUSH ENTER) | 12 Battery cover |

※ The USB terminal is a terminal that will be used in the future to update the microprocessor program, etc.

7 SETTING UP THE SYSTEM

- Once all connections with other AV components have been completed as described in "CONNECTIONS" (see pages 6 to 13), make the various settings described below on the monitor screen using the AVR-5800's on-screen display function. These settings are required to set up the listening room's AV system centered around the AVR-5800.
- Use the following buttons to set up the system:

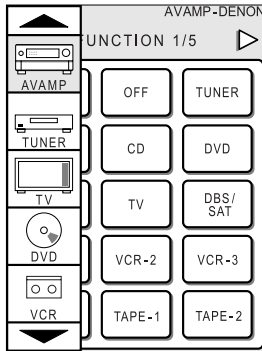

Screen while icons are displayed

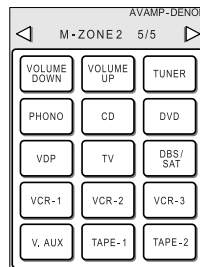
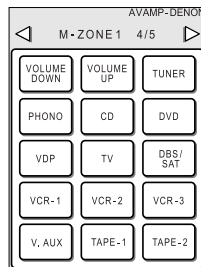
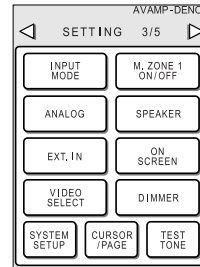
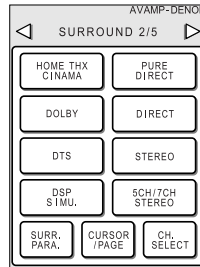
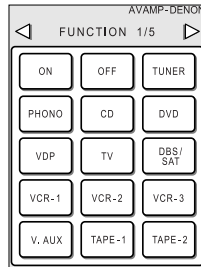

Transmission codes of independent buttons

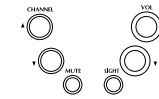

- CHANNEL▲ : Tuner preset
- CHANNEL▼ : Tuner preset
- VOL▲ : Main volume of AV amplifier
- VOL▼ : Main volume of AV amplifier
- MUTE : Muting of AV amplifier

- System setup items and default values (set upon shipment from the factory)

System setup		Default settings												
1	Speaker Configuration	Input the combination of speakers in your system and their corresponding sizes (SMALL for regular speakers, LARGE for full-size, full-range) to automatically set the composition of the signals output from the speakers and the frequency response.	Front Sp.		Center Sp.	Surround Sp.	Surround Back Sp.		Sub Woofer					
	(Surround Speaker Setting)	Use this function when using multiple surround speaker combinations for more ideal surround sound. Once the combinations of surround speakers to be used for the different surround modes are preset, the surround speakers are selected automatically according to the surround mode.	Surround mode	DOLBY/DTS SURROUND	THX SURROUND	WIDE SCREEN	5CH/7CH STEREO	DSP SIMULATION	EXT. IN-1	EXT. IN-2	—			
	Subwoofer mode	This selects the subwoofer speaker for playing deep bass signals.	Surround speaker	A	A	A	A	A	A	A	—			
2	SB CH Auto Flag Detect	Set the method of playing the surround back channel for digital signals.	LFE —THX—											
3	Delay Time	This parameter is for optimizing the timing with which the audio signals are produced from the speakers and subwoofer according to the listening position.	Auto Flag Detect Mode = OFF		Front L & R	Center	Surround L & R	SBL & SBR	Sub Woofer					
4	Multi Zone Control	Multi Zone-1 vol. Level	This sets the output level for the multi-zone 1 output jacks.	Front L & R		Center	Surround L & R	SBL & SBR	Sub Woofer					
	Power AMP Assignment	Set this to switch the surround back channel's power amplifier for use for multi-zone 2.	Variable											
5	Channel Level	This adjusts the volume of the signals output from the speakers and subwoofer for the different channels in order to obtain optimum effects.	Surround Back											
6	Subwoofer Peak Limit Lev	This parameter is for detecting the maximum level of the low bass signals output from the subwoofer channel in order to protect the subwoofer from damage and prevent unpleasant distorted sounds from being produced.	Front L	Front R	Center	Surround L	Surround R	Surround Back L	Surround Back R	Subwoofer				
7	Digital In Assignment	This assigns the digital input jacks for the different input sources.	0 dB	0 dB	0 dB	0 dB	0 dB	0 dB	0 dB	0 dB				
	Input source		CD	DVD	VDP	TV	DBS/SAT	VCR-1	VCR-2	VCR-3	TAPE-1	TAPE-2	V. AUX	
8	On Screen Display	This sets whether or not to display the on-screen display that appears on the monitor screen when the controls on the remote control unit or main unit are operated (from MONITOR 1 outputs only).	Digital Inputs	COAXIAL 1	COAXIAL 2	COAXIAL 3	OPTICAL 1	OPTICAL 2	OPTICAL 3	OPTICAL 4	OFF	OPTICAL 5	OPTICAL 6	OFF
	Auto Tuner Presets	FM stations are received automatically and stored in the memory.	On Screen Display = ON											
9	Auto Tuner Presets	FM stations are received automatically and stored in the memory.	A1 ~ A8	87.5/89.1/98.1/107.9/90.1/90.1/90.1/90.1 MHz										
			B1 ~ B8	520/600/1000/1400/1500/1710 kHz/90.1/90.1 MHz										
			C1 ~ C8	90.1 MHz										
			D1 ~ D8	90.1 MHz										
			E1 ~ E8	90.1 MHz										

NOTES:

- The on-screen display signals are not output from the MONITOR OUT-2 output jack or the color difference (component) video signal (MONITOR OUT) jacks.
- The on-screen display signals are output with priority to the S-VIDEO MONITOR OUT jack during playback of a video component. For example, if the TV monitor is connected to both the AVR-5800's S-Video and video monitor output jacks and signals are input to the AVR-5800 from a video source (VDP, etc.) connected to both the S-Video and video input jacks, the on-screen display signals are output with priority to the S-Video monitor output. If you wish to output the signals to the video monitor output jack, do not connect a cord to the S-VIDEO MONITOR OUT jack. (For details, see page 30.)
- The AVR-5800's on-screen display function is designed for use with high resolution monitor TVs, so it may be difficult to read small characters on TVs with small screens or low resolutions.
- The setup menu is not displayed when headphones are being used.

• Speaker system layout

Basic system layout (For a THX Surround EX system)

- The following is an example of the basic layout for a system consisting of eight speaker systems and a television monitor:

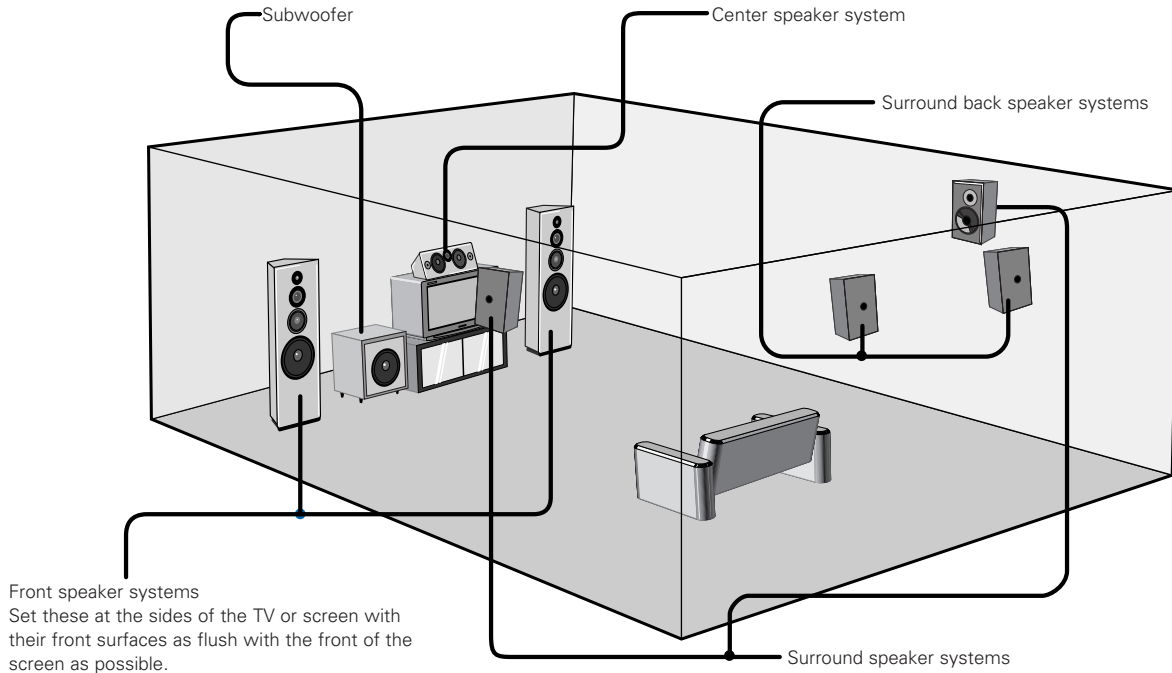

Front speaker systems
Set these at the sides of the TV or screen with their front surfaces as flush with the front of the screen as possible.

With the AVR-5800 it is also possible to use the surround speaker selector function to choose the best layout for a variety of sources and surround modes.

• Surround speaker selector function

This function makes it possible to achieve the optimum sound fields for different sources by switching between two systems of surround speakers (A and B). The settings of the different speakers (A only, B only or A+B) are stored in the memory for the different surround modes, so they are set automatically when the surround mode is selected.

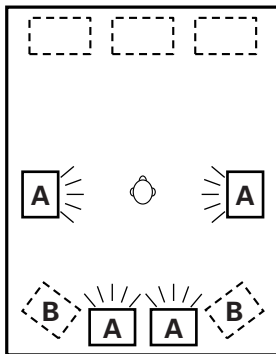

Using A only
(Multi surround speaker system)

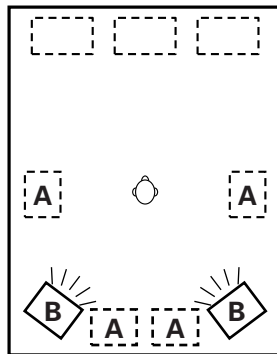

Using B only
(Single surround speaker system)

- It is also possible to select surround speakers A+B, but we recommend using the more effective multi surround speaker system with the surround back speakers.

Before setting up the system

- 1**  Check that all the connections are correct, then turn on the main unit's power.
(Main unit)

- 2** Either lightly press on the remote control unit's touch panel or press the LIGHT button to turn on the liquid crystal display. (The back light does not turn on when the touch panel is pressed.)

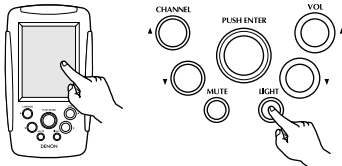

- 3** By default the liquid crystal display is set to display for 10 seconds, but this can be changed to approximately 120 seconds using the procedure described below so that operations during system up can be performed securely.

- 4**  Lightly press the remote control unit's jog stick (PUSH ENTER) to display the icon display section.

- 5** Press the "▼" button in the icon display section to display the "SETUP" icon.

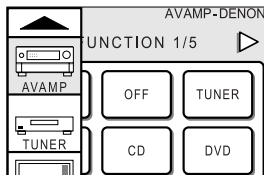

- 6** Press the "SETUP" icon for at least 3 seconds to display the setup screen.

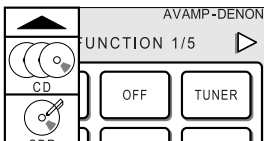

- 7**  Push the remote control unit's jog stick to the right to display the "SETUP 4/4" page.

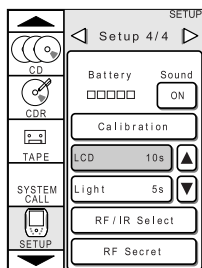

Press the "LCD 10s" button on this page so that this part is displayed in half-tone dot mesh.

Now press the "▲" button to set the time display to "120".

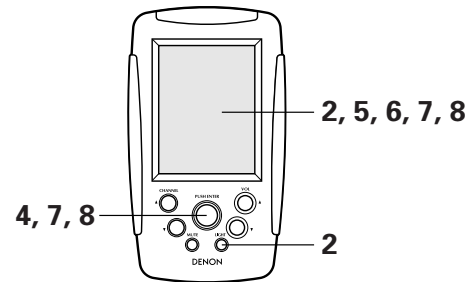
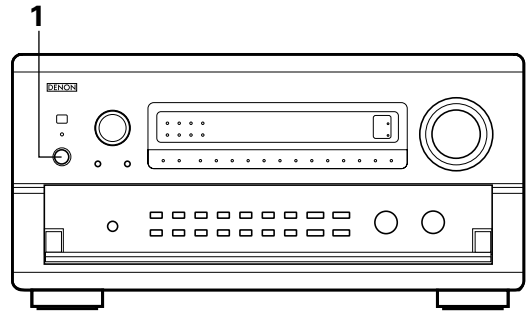

- 8** Press the "▼" button in the icon display section to display the "AVAMP" icon. Press the "AVAMP" icon to display the page section.

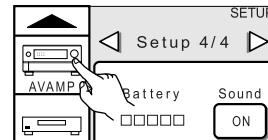

Push the remote control unit's jog stick to the right to display the "SETUP 3/5" page.

Press "SYSTEM SETUP" at the bottom left to display the "System Setup Menu" on the TV screen.

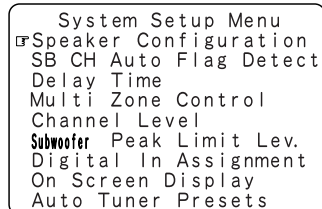
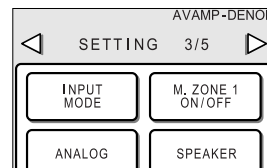

Setting the type of speakers

- The composition of the signals output from the different channels and the frequency response are adjusted automatically according to the combination of speakers actually being used.

1 Press "CURSOR/PAGE" at the center of the bottom line on the "AV AMP's" "SETTING 3/5" page so that this part is displayed in half-tone dot mesh. Make the system setups by pushing the jog stick on the remote control unit forward and backward, left and right.

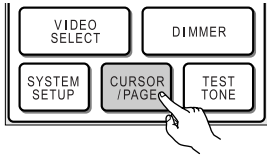

2 At the System Setup Menu select "Speaker Configuration".

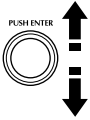

3 Switch to the speaker configuration screen.



4 Set whether or not speakers are connected and, if so, their size parameters.

- To select the speaker

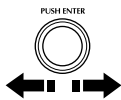
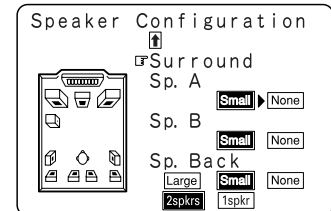
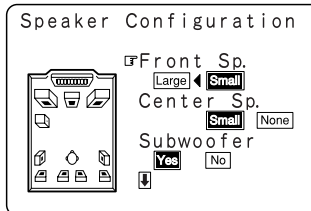
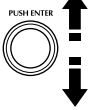

- To select the parameter

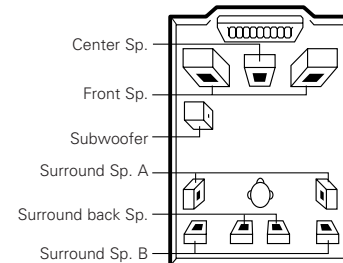

5 Enter the setting.

- If no surround speakers are used (if "None" is set for both A and B):
The System Setup Menu reappears.
- If both surround speakers A and B are used (if either "Large" or "Small" is set for both A and B):
The surround speaker setting screen appears.
- When "Front" is set to "Large" and "Subwoofer" is set to "Yes", the set switches to the subwoofer mode.
- If "None" is set for surround speakers A:
"None" is automatically set for surround speakers B and surround back speaker.

NOTE:

- Select "Large" or "Small" not according to the actual size of the speaker but according to the speaker's capacity for playing low frequency (approximately 80 Hz and below) signals. If you do not know, try comparing the sound at both settings (setting the volume to a level low enough so as not to damage the speakers) to determine the proper setting.

Parameters

- LargeSelect this when using speakers that can fully reproduce low sounds of below 80 Hz.
- SmallSelect this when using speakers that cannot reproduce low sounds of below 80 Hz with sufficient volume.
When this setting is selected, low frequencies of below 80 Hz are assigned to the subwoofer.
- None.....Select this when no speakers are installed.
- Yes/No.....Select "Yes" when a subwoofer is installed, "No" when a subwoofer is not installed.
- 2spkr/1spkr.....Select the number of speakers to be used for the surround back channel.
- ※ If the subwoofer has sufficient low frequency playback capacity, good sound can be achieved even when "Small" is set for the front, center and surround speakers.
- ※ To take full advantage of the performance of the Home THX certified speaker systems, set the front, center and surround speaker size parameters to "Small" and the subwoofer to "Yes".
- ※ For the majority of speaker system configurations, using the SMALL setting for all five main speakers and Subwoofer On with a connected subwoofer will yield the best results.
- ※ When "Front" is set to "Small", "Subwoofer" is automatically set to "Yes", and when "Subwoofer" is set to "No", "Front" is automatically set to "Large".

Selecting the surround speakers for the different surround modes

- At this screen preset the surround speakers to be used in the different surround modes.

1

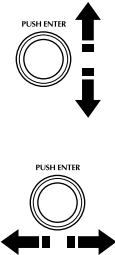

When either "Large" or "Small" has been set for both speakers A and B on the System Setup Menu (when using both A and B surround speakers), the surround speaker setting screen appears. Select the surround speakers to be used in the different surround modes.

- To select the surround mode
- To select the surround speaker

A: When using surround speakers A
 B: When using surround speakers B
 A+B: When using both surround speakers A and B

Surround Sp.	Setting
DOLBY/DTS SURROUND	A B A+B
THX/THX5.1	A B A+B
WIDE SCREEN	A B A+B
5/7CH STEREO	A B A+B
DSP	A B A+B
SIMULATION	
EXT. IN-1	A B A+B
EXT. IN-2	A B A+B

2



Enter the setting.
 When "Front" is set to "Large" and "Subwoofer" is set to "Yes", the set switches to the subwoofer mode.

- ※ Speaker type setting when using both surround speakers A and B
 If "Small" is set for either surround speakers A or B, the output is the same as when "Small" is set for both A and B.
- ※ For the "WIDE SCREEN" and "5/7CH STEREO" DSP simulation modes, the surround speakers can be set separately.

Setting the Subwoofer mode

1



Select the subwoofer mode.

Subwoofer Mode	
LFE -THX-	LFE +Main

2



Enter the setting.
 The System Setup Menu reappears.

NOTES:

— Assignment of low frequency signal range —

- The only signals produced from the subwoofer channel are LFE signals (during playback of Dolby Digital or DTS signals) and the low frequency signal range of channels set to "SMALL" in the setup menu. The low frequency signal range of channels set to "LARGE" are produced from those channels.

— Subwoofer mode —

- The subwoofer mode setting is only valid when "LARGE" is set for the front speakers and "YES" is set for the subwoofer in the "Speaker Configuration" settings (see page 19).
- When the "LFE+MAIN" playback mode is selected, the low frequency signal range of channels set to "LARGE" are produced simultaneously from those channels and the subwoofer channel.
In this playback mode, the low frequency range expand more uniformly through the room, but depending on the size and shape of the room, interference may result in a decrease of the actual volume of the low frequency range.
- Selection of the "LFE - THX" play mode will play the low frequency signal range of the channel selected with "LARGE" from that channel only. Therefore, the low frequency signal range that are played from the subwoofer channel are only the low frequency signal range of LFE (only during Dolby Digital or DTS signal playback) and the channel specified as "SMALL" in the setup menu. THX is recommended in this play mode so that bass interference is less likely to occur in the room.
- Select the play mode that provides bass reproduction with body.

Setting the Surround Back channel

Set the operation for the digital signals when playing in the 6.1 SURROUND, DTS-ES and THX SURROUND EX surround modes.

1  At the System Setup Menu select "SB CH Auto Flag Detect" and press the ENTER button.

System Setup Menu
 Speaker Configuration
 SB CH Auto Flag Detect
 Delay Time
 Multi Zone Control
 Channel Level
 Subwoofer Peak Limit Lev.
 Digital In Assignment
 On Screen Display
 Auto Tuner Presets

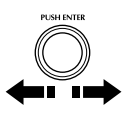
2  Select the desired setting.

※ We recommend setting this to "OFF".
 When set to "ON", the operation for software for which no identification signals are recorded is set.

THX Surround EX / DTS ES
 Auto Flag Detect Mode
 ON |< : >| OFF

THX Surround EX / DTS ES
 Auto Flag Detect Mode
 ON |< : >| OFF
 Non-Flag Source
 SBch Output
 THX Surround EX NON- OFF
 DTS ES MTRX

3  Enter the setting.
The System Setup Menu reappears.

THX surround EX/DTS ES Auto Flag Detect Mode (AFDM) setting

- OFF.....Set the "OFF" mode to perform 6.1-channel playback with conventional 5.1-channel sources or sources on which the identification signal described below is not recorded.
- ON.....This function only works with software on which a special identification signal is recorded. This software is scheduled to go on sale in the future.
This is a function for automatically playing in the 6.1-channel mode using the surround back speakers if the software is recorded in THX Surround EX or DTS-ES or in the normal 5.1-channel mode without using the surround back speakers when the software is not recorded in THX Surround EX or DTS-ES.

Non-Flag Source SB ch Output setting

- OFF.....Playback is conducted without using the surround back speaker.
- Non MTRX.....Playback is conducted using the surround back speaker. The same signals as those of the surround channels are output from the surround back channel.
- THX surround EX/DTS ES.....Playback is conducted using the surround back speaker.
Surround back channel is reproduced using digital matrix processing.

NOTES:

- The "SB CH Auto Flag Detect" setting screen is displayed when the surround back speaker is set to "Large" or "Small" at "Speaker Configuration".
- The surround back speakers can also be turned on and off using the "SB CH OUT" surround parameter. (See pages 51.)
Select the setting according to the program source to be played.

Setting the delay time

- Input the distance between the listening position and the different speakers to set the delay time for the surround mode.
- The delay time can be set separately for surround speakers A and B.

Preparations:

Measure the distances between the listening position and the speakers (L1 to L5 on the diagram at the right).

- L1: Distance between center speaker and listening position
- L2: Distance between front speakers and listening position
- L3: Distance between surround speakers and listening position
- L4: Distance between surround back speakers and listening position
- L5: Distance between subwoofer and listening position

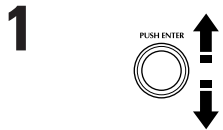
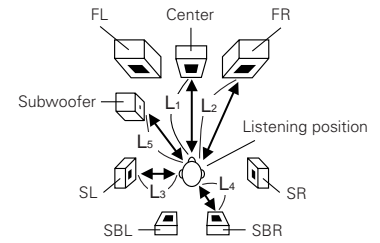

At the System Setup Menu select "Delay Time".

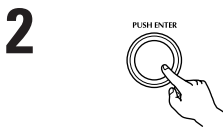
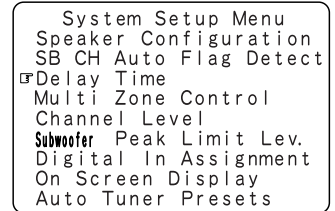

Switch to the Delay Time screen.

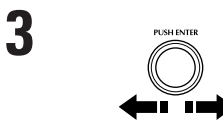
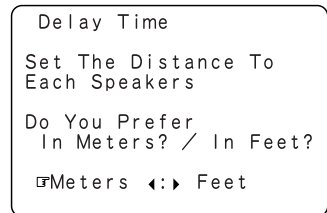

Select the desired unit, meters or feet.
Select (darken) the desired units, "Meters" or "Feet".

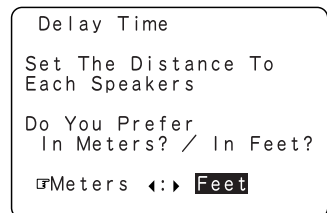

Example: When "Feet" is selected

4 Once "Meter" or "Feet" is selected in Step 3, the Delay Time screen appears automatically.

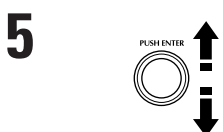
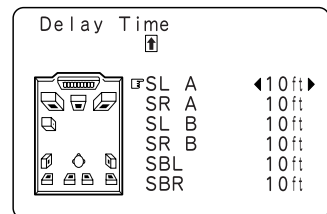
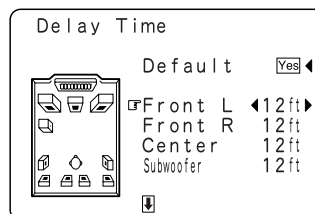

At the System Setup Menu select "Delay Time".

6

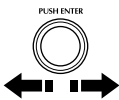

Set the distance between the center speaker and listening position.
The distance changes in units of 1 foot (0.1 meters) each time the button is pressed. Select the value closest to the measured distance.

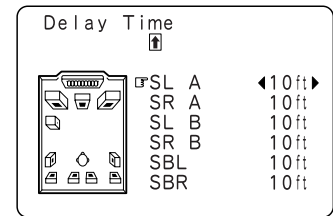
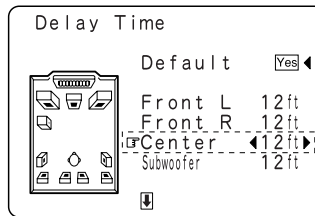

Example: When the distance is set to 12 feet for the center speaker

※ If "Yes" is selected for "Default", the settings are automatically reset to the default values.

Please note that the difference of distance for every speaker should be 15 ft (4.5 m) or less. If you set an invalid distance, a CAUTION notice, such as screen right will appear. In this case, please relocate the blinking speaker(s) so that its distance is no larger than the value shown in highlighted line.

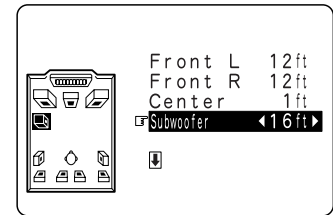

7



Enter the setting.
The System Setup Menu reappears.
The AVR-5800 automatically sets the optimum surround delay time for the listening room.

Setting the Multi Zone Control

The AVR-5800 is equipped with two sets of multi-zone outputs.
Multi-zone 1 is a pre-output with an output level adjustment function.
Multi-zone 2 is a fixed output level pre-output. Using the power amplifier assignment function described below, it is also possible to connect speakers to the multi-zone 2 speaker terminals.

[1] Setting the multi-zone 1 level

1

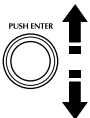

At the System Setup Menu, select "Multi Zone Control".

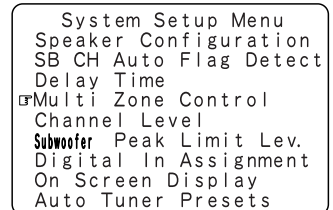

2



Press jog stick "ENTER" to switch to the "Multi Zone Control" screen.

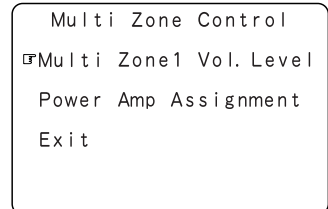

3

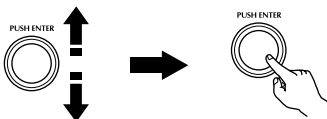

Select "Multi Zone1 Vol. Level" then press jog stick "ENTER".

4 Select the desired setting, then press jog stick "ENTER".

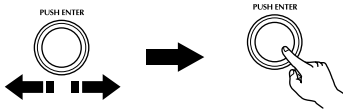

Variable:

The level can be adjusted freely using the buttons on the remote control unit (M. ZONE 1 4/5, VOLUME UP and VOLUME DOWN).

-40 dB, 0 dB:

The output level is fixed at the set level and the volume can no longer be adjusted.

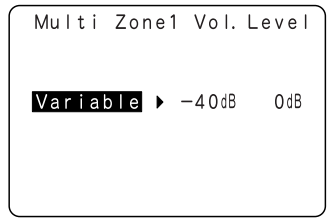

[2] Power amplifier assignment function setting

Make this setting to switch the power amplifier for the surround back channel to Multi-zone 2.

1 At the System Setup Menu, select "Multi Zone Control".

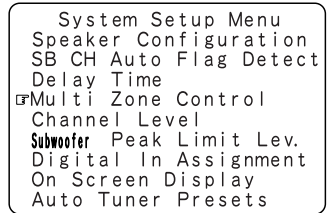
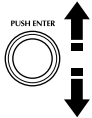

2 Press jog stick "ENTER" to switch to the "Multi Zone Control" screen.

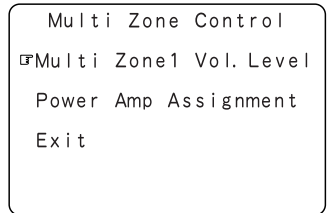

3 Select "Power Amp Assignment" then press the "ENTER" button on the jog stick.

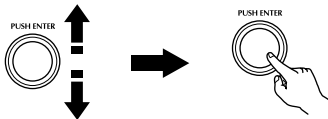

4 Select "Surround Back" to use as the surround back channel, "Zone-2" to use as multi-zone 2, then press jog stick "ENTER".

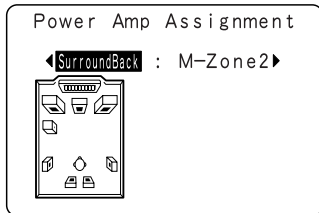
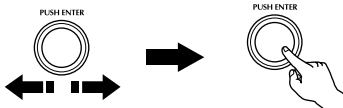

When "Surround Back" is selected

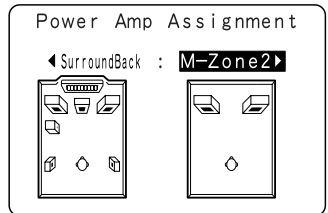

When "M-Zone2" is selected

Setting the channel level

- Use this setting to adjust so that the playback level between the different channels is equal.
- From the listening position, listen to the test tones produced from the speakers to adjust the level.
- The level can also be adjusted directly from the remote control unit. (For details, see page 42.)
- When using both surround speakers A and B, their playback levels can be adjusted separately.

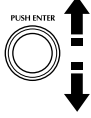
- 

At the System Setup Menu select "Channel Level".

System Setup Menu
 Speaker Configuration
 SB CH Auto Flag Detect
 Delay Time
 Multi Zone Control
 Channel Level
 Subwoofer Peak Limit Lev.
 Digital In Assignment
 On Screen Display
 Auto Tuner Presets
- 

Switch to the Channel Level screen.

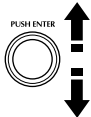
Channel Level
 Test Tone **Auto** : Manual
 Surr. Sp. **A** B A+B
 Test Tone Start **Yes**
 Level Clear **Yes**
- 

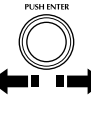
Select "Test Tone Mode".
- 

Select the mode.
 Select "Auto" or "Manual".

 - Auto:
 Adjust the level while listening to the test tones produced automatically from the different speakers.
 - Manual:
 Select the speaker from which you want to produce the test tone to adjust the level.

Channel Level
 Test Tone **Auto** : Manual
 Surr. Sp. **A** B A+B
 Test Tone Start **Yes**
 Level Clear **Yes**

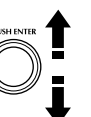
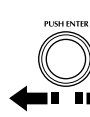
Example: When the "Auto" mode is selected
- 

Select "Surr. Sp.", then select the surround speaker(s) from which you want to produce the test tone (A, B or A+B).

 - Surr. Sp.: A
 Adjusts the balance of the playback level between the channels when using surround speaker A.
 - Surr. Sp.: B
 Adjusts the balance of the playback level between the channels when using surround speaker B.
 - Surr. Sp.: A+B
 Adjusts the balance of the playback level between the channels when using surround speakers A and B at the same time.

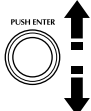
※ The "Surr. Sp." can only be selected when both surround speakers A and B have been selected at the "Speaker Configuration" (when both A and B have been set to "Large" or "Small").
- 

Select "Test Tone Start".

7



Select "Yes".

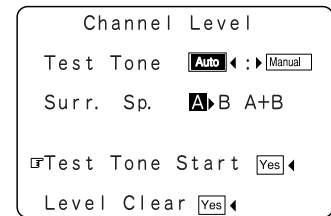

8

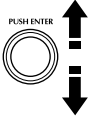

a. If the "Auto" mode is selected:

Test tones are automatically emitted from the different speakers. The test tones are emitted from the different speakers in the following order, at 4-second intervals the first time and second time around, 2-second intervals the third time around and on:

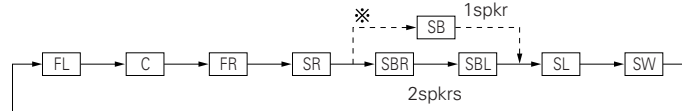

※ When the surround back speaker setting is set to "1spkr" for "Speaker Configuration", this is set to "SB".

Use the CURSOR buttons to adjust all the speakers to the same volume. The volume can be adjusted between -12 dB and +12 dB in units of 1 dB.

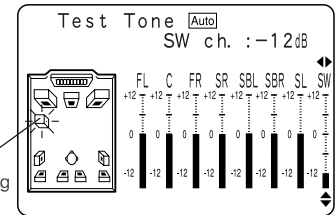

Example: When the volume is set to -12 dB while the test tone is being produced from the subwoofer

b. When the "Manual" mode is selected

Move jog stick "ENTER" left and right to select the speaker for which you want to output test tones, then move jog stick "ENTER" back and forth to adjust so that the volume of the test tones from the various speakers is the same.

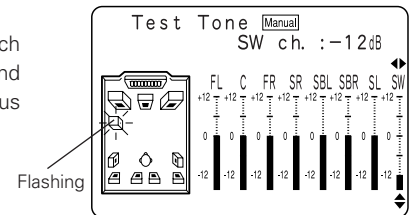
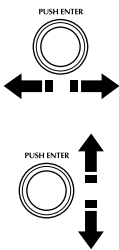

Example: When the volume is set to -12 dB while the subwoofer is selected

9



After the above settings are completed, press the ENTER button again. The "Channel Level" screen reappears.

※ To cancel the settings, select "Level Clear" and "Yes" on the "Channel Level" screen, then make the settings again.

The level of each channel should be adjusted to 75 dB (C-weighted, slow meter mode) on a sound level meter at the listening position.

If a sound level meter is not available adjust the channels by ear so the sound levels are the same. Because adjusting the subwoofer level test tone by ear is difficult, use a well known music selection and adjust for natural balance.

NOTE: When adjusting the level of an active subwoofer system, you may also need to adjust the subwoofer's own volume control.

- ※ When you adjust the channel levels while in the SYSTEM SETUP CHANNEL LEVEL mode, the channel level adjustments made will affect ALL surround modes. Consider this mode a Master Channel Level adjustment mode.
- ※ After you have completed the SYSTEM SETUP CHANNEL LEVEL adjustments, you can then activate the individual surround modes and adjust channel levels that will be remembered for each of those modes. Then, whenever you activate a particular surround sound mode, your preferred channel level adjustments for just that mode will be recalled. Check the instructions for adjusting channel levels within each surround mode on Page 42.
- ※ You can adjust the channel levels for each of the following surround modes: DIRECT, STEREO, 5CH/7CH STEREO, DOLBY/DTS SURROUND, HOME THX CINEMA, WIDE SCREEN, SUPER STADIUM, ROCK ARENA, JAZZ CLUB, CLASSIC CONCERT, MONO MOVIE, and MATRIX.
- ※ When using either surround speakers A or B, or when using surround speakers A and B at the same time, be sure to adjust the balance of playback levels between each channel for the various selections of "A or B" and "A and B".

Subwoofer peak limit level setting

- This unit features a subwoofer peak limit control which prevents distortion and damage in the loudspeaker system by controlling the maximum bass volume level. With this feature you may set the maximum bass level for the system.
- This feature operates with or without a subwoofer in the system.

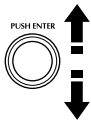
1  At the System Setup Menu select "Subwoofer Peak Limit Lev."

System Setup Menu
 Speaker Configuration
 SB CH Auto Flag Detect
 Delay Time
 Multi Zone Control
 Channel Level
 Subwoofer Peak Limit Lev.
 Digital In Assignment
 On Screen Display
 Auto Tuner Presets

2  Switch to the Subwoofer Peak Limit Level Setting screen.

Subwoofer Peak
 Limit Level Setting

Find The Level When
 Distortion Begins.

Peak Limiter ON OFF

3  Select "ON" for Peak Limiter.

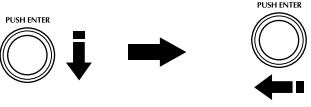
4  The screen switches. Select "Setting Start", then select "Yes".
 The screen switches and a test noise is produced from the speaker system.

Subwoofer Peak
 Limit Level Setting

Find The Level When
 Distortion Begins.

Peak Limiter ON OFF
 Setting Start Yes No

[Peak Limiter -18dB]

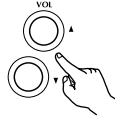
5  Increase the master volume level until the test noise is distorted.
 The test noise (bass sound) is distorted when it sounds as if the input is excessively high (when the sound crackles).

Subwoofer Peak
 Limit Level Setting

Turn Up The Volume
 With
 Master Vol. Button

When Distortion Begins
 Push Enter Button.

6  Press the ENTER button at the point where the test noise starts sounding distorted.
 The AVR-5800 automatically sets the subwoofer peak limit level.
 This prevents future inadvertent subwoofer overload due to excessively strong bass content when the master volume control is at a high level.

※ Clear the subwoofer's peak limit level setting by specifying "Peak Limiter" and "OFF".

CAUTION!

- The master volume is set to “-30 dB” when test tones are output.
- The test tones are for confirming the low frequency playback limits and are played at an extremely high level. When using a low output subwoofer, be very careful about irregular operations exceeding clipping by for example turning down the subwoofer’s attenuator before starting then slowly turning the attenuator up to the listening level.
- Also, when the subwoofer is set to “NO” in the speaker configuration, the test tones are output from the front speakers. When using front speakers with low input resistance, check that the sound is not clipped at sections where the signal is strong on the CD music source before starting the peak limit setting. The peak limit setting should not be performed if the music source cannot be played with the master volume set at “-15”. Set the front speakers to “small” and the subwoofer to “YES” in the speaker configuration. When this is done, the low frequencies are cut, so the effect is insufficient. We strongly recommend adding a subwoofer.
- If the test tone is clipped when it is set to “-18 dB”, set the peak limit to “-18 dB”. In this case, the input resistance of the subwoofer or front speakers is insufficient so clipping may occur when playing music. We recommend switching to a subwoofer with a higher input resistance.

Setting the Digital In Assignment

- This setting assigns the digital input jacks of the AVR-5800 for the different input sources.

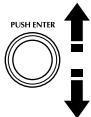
1  At the System Setup Menu select “Digital In Assignment”.

System Setup Menu
Speaker Configuration
SB CH Auto Flag Detect
Delay Time
Multi Zone Control
Channel Level
Subwoofer Peak Limit Lev.
Digital In Assignment
On Screen Display
Auto Tuner Presets

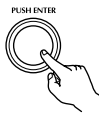
2  Switch to the Digital In Assignment screen.

Digital In Assignment

CD	: COAX1	TAPE-1	: OPT5
DVD	: COAX2	TAPE-2	: OPT6
VDP	: COAX3	V.AUX	: OFF
TV	: OPT1		
DBS	: OPT2		
VCR-1	: OPT3	Default	Yes
VCR-2	: OPT4		
VCR-3	: OFF		

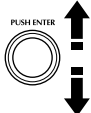
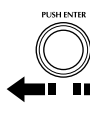
3   Select the digital input jack to be assigned to the input source.

- To select the input source
- To select the digital input jack

Select “OFF” for input sources for which no digital input jacks are used.

※ If “Yes” is selected for “Default”, the settings are automatically reset to the default values.

4  Enter the setting.
The System Setup Menu reappears.



NOTES:

- The OPTICAL 5 and 6 jacks on the AVR-5800’s rear panel are equipped with an optical digital output jack for recording digital signals on a DAT deck, MD recorder or other digital recorder. Use this for digital recording between a digital audio source (stereo - 2 channel) and a digital audio recorder.
- Do not connect the output of the component connected to the OPTICAL 5 OUT jack on the AVR-5800’s rear panel to any jack other than the OPTICAL 5 IN jack.
- Do not connect the output of the component connected to the OPTICAL 6 OUT jack on the AVR-5800’s rear panel to any jack other than the OPTICAL 6 IN jack.
- “PHONO” and “TUNER” cannot be selected on the Digital In Assignment screen.

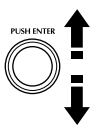
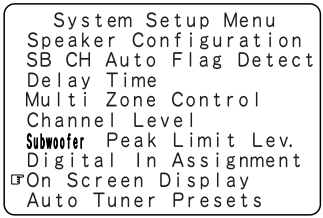

Setting the on-screen display (OSD)

- Use this to turn the on-screen display (messages other than the menu screens) on or off.

-  At the System Setup Menu select "On Screen Display".

```
System Setup Menu
Speaker Configuration
SB CH Auto Flag Detect
Delay Time
Multi Zone Control
Channel Level
Subwoofer Peak Limit Lev.
Digital In Assignment
On Screen Display
Auto Tuner Presets
```
-  Switch to the On Screen Display screen.

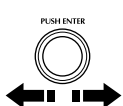
```
On Screen Display

ON ← : → OFF
```
-  Select "ON" or "OFF".
-  Enter the setting.
The System Setup Menu reappears.

Auto tuner presets

Use this to automatically search for FM broadcasts and store up to 40 stations at preset channels A1 to 8, B1 to 8, C1 to 8, D1 to 8 and E1 to 8.

NOTES:

- If an FM station cannot be preset automatically due to poor reception, use the "Manual tuning" operation to tune in the station, then preset it using the manual "Preset memory" operation.

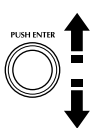
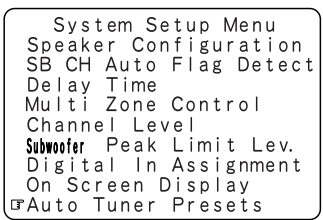
-  At the System Setup Menu select "Auto Tuner Presets".

```
System Setup Menu
Speaker Configuration
SB CH Auto Flag Detect
Delay Time
Multi Zone Control
Channel Level
Subwoofer Peak Limit Lev.
Digital In Assignment
On Screen Display
Auto Tuner Presets
```

2



Switch to the Auto Preset Memory screen.

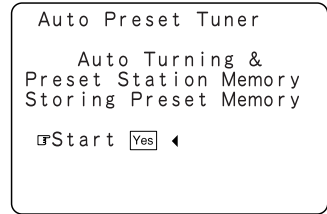

3

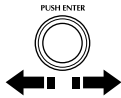

Select "Yes" for Start.
 "Search" flashes on the screen and searching begins.
 "Completed" appears once searching is completed.
 The display automatically switches to screen.

※ This completes system setup. Once these settings are made, there is no need to change them unless different AV components are connected or the speakers are repositioned.

After completing system setup

This button can be pressed at any time during the system setup process to complete the process.

1

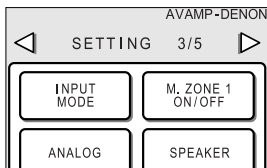

At the System Setup Menu, press the SYSTEM SETUP button.
 ※ The changed settings are entered and the on-screen display turns off.

※ Finally set the remote control unit (RC-8000) display time setting to a time that is short but long enough that operation is possible.

• On-screen display signals

	Signals input to the AVR-5800		On-screen display signal output	
	VIDEO signal input jack (yellow)	S-video signal input jack	VIDEO MONITOR OUT-1 video signal output jack (yellow)	S-video MONITOR OUT-1 video signal output jack
1	×	×	○	○
2	○	×	○	×
3	×	○	×	○
4	○	○	×	○

(○: Signal ×: No signal)
 (○: On-screen signals output ×: On-screen signals not output)

NOTES:

- The on-screen display signals are not output from the video signal MONITOR OUT-2 (yellow) or S-Video signal MONITOR OUT-2 jacks.
- The on-screen display signals are not output from the color difference (component) video signal MONITOR OUT jacks.
- For 4 above, the on-screen display signals are output to the VIDEO MONITOR OUT-1 video signal output jack (yellow) if the monitor TV is not connected to the S-video MONITOR OUT-1 video signal output jack.

8 REMOTE CONTROL UNIT

- The included remote control unit (RC-8000) can be used to operate not only the AVR-5800 but other remote control compatible DENON components as well. Furthermore, it is equipped with a function for learning the control signals of remote control units of other manufacturers, so it can also be used to operate non-DENON remote control compatible video components.
- **For details, refer to the separate (supplied) RC-8000 operating instructions.**

Using the remote control unit

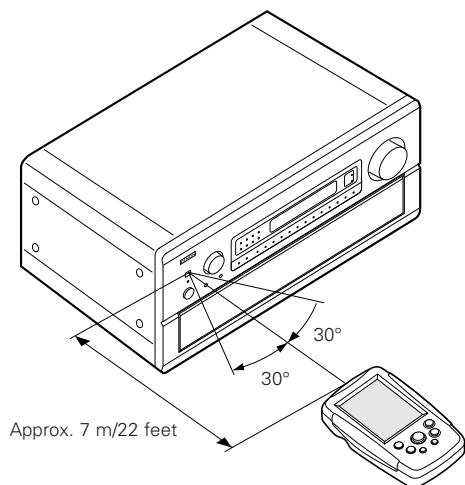

- Point the remote control unit at the remote sensor on the main unit as shown on the diagram.
- The remote control unit can be used from a straight distance of approximately 7 meters/22 feet from the main unit, but this distance will be shorter if there are obstacles in the way or if the remote control unit is not pointed directly at the remote sensor.
- The remote control unit can be operated at a horizontal angle of up to 30 degrees with respect to the remote sensor.

NOTES:

- It may be difficult to operate the remote control unit if the remote sensor is exposed to direct sunlight or strong artificial light.
- Do not press buttons on the main unit and remote control unit simultaneously. Doing so may result in malfunction.
- Neon signs or other devices emitting pulse-type noise nearby may result in malfunction, so keep the set as far away from such devices as possible.

9 OPERATION

Before operating

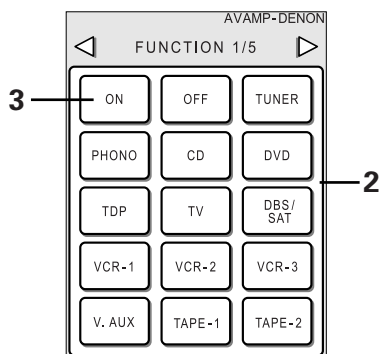
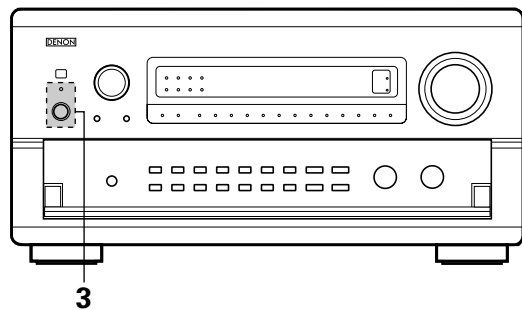

1 Refer to "CONNECTIONS" (pages 6 to 13) and check that all connections are correct.

2 To operate with the remote control unit, set the remote control unit's screen to the "AVAMP 1/5" page.

3 Turn on the power.
Press the POWER operation switch (button).

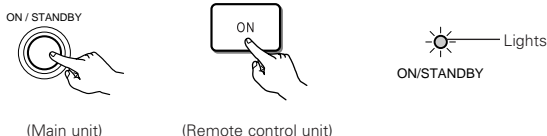

- When pressed, the power turns on and the display lights. The sound is muted for several seconds, after which the unit operates normally.
- When pressed again, the power turns off, the standby mode is set and the display turns off.
- Whenever the ON/STANDBY button is in the STANDBY state, the apparatus is still connected to the AC line voltage. Please be sure to unplug the cord when you leave home for, say, a vacation.

Operating the remote control unit

• For details, refer to the separate (supplied) RC-8000 operating instructions.

1 Either lightly press on the remote control unit's touch panel or press the LIGHT button to turn on the liquid crystal display.

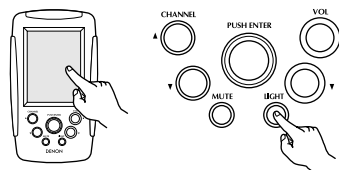

2 Remote control unit's jog stick

Lightly press "ENTER" to display the icons.



Press the "▼" button on the icon display section to display the "AVAMP" icon.

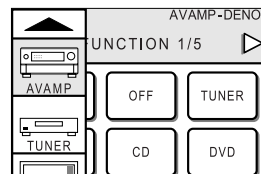

Press the "AVAMP" icon to display the page section.

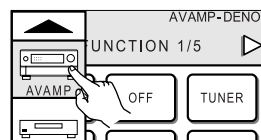

Move the remote control unit's jog stick "ENTER" left and right to display the necessary page.

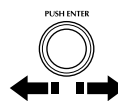

3 When the CURSOR/PAGE button is pressed and the display is in half-tone dot mesh, the joystick operates as the cursor up/down and left/right buttons and the ENTER button. (**This is called the cursor mode.**)

The display switches between normal and half-tone dot mesh each time the CURSOR/PAGE button is pressed, thus switching between the page mode and the cursor mode. (**When the display is normal, the page mode is set.**)

Normal display (page mode)



Half-tone dot mesh display (cursor mode)



Playing the input source

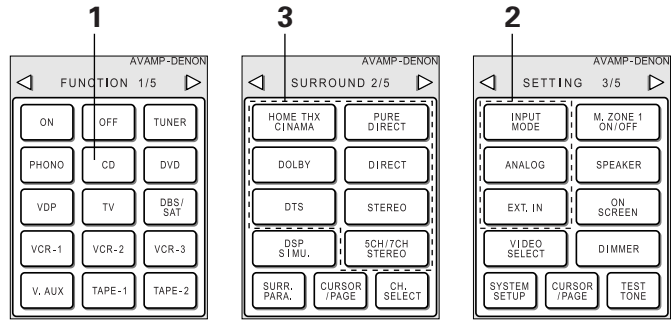
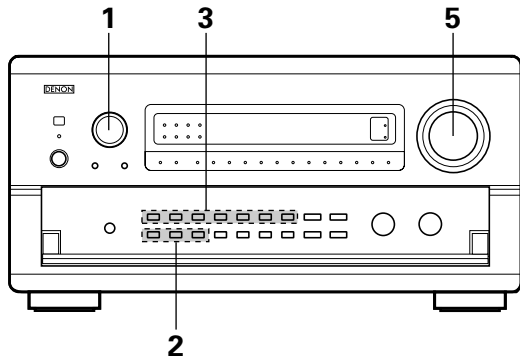

1 Select the input source to be played.

Example: CD

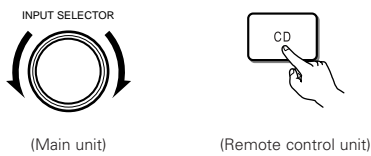

※ When the input source is selected, the input indicator lights.

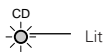

2 Select the input mode.

- Selecting the analog mode
Press the ANALOG button to switch to the analog input.

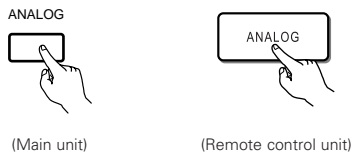

- Selecting the external input (EXT. IN) mode
Press the EXT. IN (on the EXT. IN button on the remote control unit) to switch the external input.

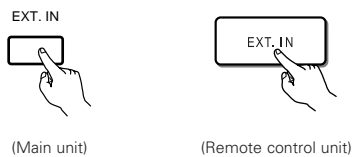

- Selecting the AUTO, PCM and DTS modes
The mode switches as shown below each time the INPUT MODE button is pressed.

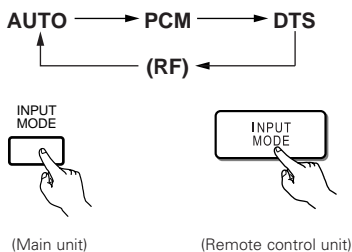

Input mode selection function

Different input modes can be selected for the different input sources. The selected input modes for the separate input sources are stored in the memory.

1 AUTO (All auto mode)

In this mode, the types of signals being input to the digital and analog input jacks for the selected input source are detected and the program in the AVR-5800's surround decoder is selected automatically upon playback. This mode can be selected for all input sources other than PHONO and TUNER.

The presence or absence of digital signals is detected, the signals input to the digital input jacks are identified and decoding and playback are performed automatically in DTS, Dolby Digital or PCM (2 channel stereo) format. If no digital signal is being input, the analog input jacks are selected.

Use this mode to play Dolby Digital signals.

2 PCM (exclusive PCM signal playback mode)

Decoding and playback are only performed when PCM signals are being input.

Note that noise may be generated when using this mode to play signals other than PCM signals.

3 DTS (exclusive DTS signal playback mode)

Decoding and playback are only performed when DTS signals are being input.

4 RF (exclusive RF signal playback mode)

This can only be selected when the program source is set to VDP. Decoding and playback are only performed when RF signals are being input. This is used when the LD player has an Dolby Digital-RF (AC-3RF) output jack, but does not have a PCM digital output jack.

5 ANALOG (exclusive analog audio signal playback mode)

The signals input to the analog input jacks are decoded and played.

6 EXT. IN (external decoder input jack selection mode)

The signals being input to the external decoder input jacks are played without passing through the surround circuitry.

NOTE:

- Note that noise will be output when CDs or LDs recorded in DTS format are played in the "PCM" or "ANALOG" mode. Select the "DTS" mode when playing signals recorded in DTS from a laser disc player or CD player.

Note on playing a source encoded with DTS

- Noise may be generated at the beginning of playback and while searching during DTS playback in the AUTO mode. If so, play in the DTS mode.

3 Select the play mode.

Example: Stereo

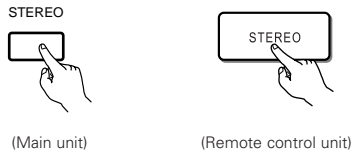

4 Start playback on the selected component.

- For operating instructions, refer to the component's manual.

5 Adjust the volume.

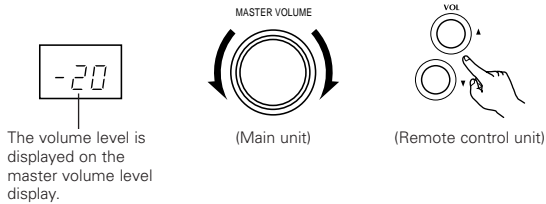

- The volume can be adjusted within the range of -60 to 0 to 18 dB, in steps of 1 dB. However, when the channel level is set as described on page 25 or page 42, if the volume for any channel is set at +1 dB or greater, the volume cannot be adjusted up to 18 dB. (In this case the maximum volume adjustment range is "18 dB — (Maximum value of channel level)".)

Input mode when playing DTS sources

- Noise will be output if DTS-compatible CDs or LDs are played in the "ANALOG" or "PCM" mode. When playing DTS-compatible sources, be sure to connect the source component to the digital input jacks (OPTICAL/COAXIAL) and set the input mode to "AUTO" or "DTS".

NOTE:

- The digital input indicator will light (green) when playing CD-ROMs containing data other than audio signals, but no sound will be heard.

Input mode display

- In the AUTO mode



- In the PCM mode

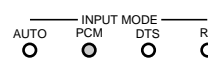

- In the DTS mode



- When switched to RF in the VDP RF or AUTO mode

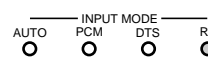

- In the ANALOG mode

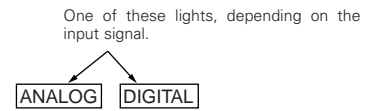

DIGITAL

DIGITAL

DIGITAL

ANALOG

Input signal display

- DOLBY DIGITAL



- DTS



- PCM



One of these lights, depending on the input signal.

PRO LOGIC

- The AL24 indicator lights when the PURE DIRECT, DIRECT or STEREO mode is selected in the digital input mode.
- The LOCK LED lights when digital signals are being input properly. If the LED does not light, check whether the digital input component setup (page 28) and connections are correct and whether the component's power is turned on.

After starting playback

[1] Adjusting the sound quality (tone)

The tone control function will not work in the Direct or Home THX Cinema mode.

- Press the MODE SELECT button and select TONE. The mode switches as follows each time the MODE SELECT button is pressed:

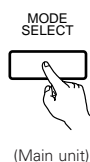
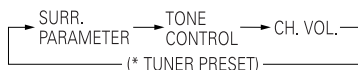

- Only displayed when the TUNER input is selected.

- Select BASS/TREBLE with the FUNCTION knob.

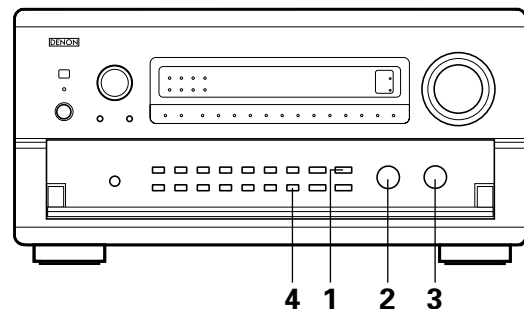
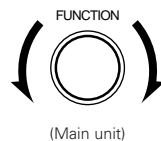

3 Adjust as desired with the CONTROL knob.

- To increase the bass or treble: Turn the control clockwise. (The bass or treble sound can be increased to up to +12 dB in steps of 2 dB.)
- To decrease the bass or treble: Turn the control counter clockwise. (The bass or treble sound can be decreased to up to -12 dB in steps of 2 dB.)

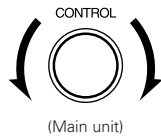

4 If you do not want the bass and treble to be adjusted, turn on the tone defeat mode.

- ✳ The signals do not pass through the bass and treble adjustment circuits, providing higher quality sound.

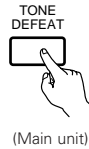

[2] Listening over headphones

Plug the headphones' plug into the jack.

- ✳ Connect the headphones to the PHONES jack.

The pre-out output (including the speaker output) is automatically turned off when headphones are connected.

NOTE:

To prevent hearing loss, do not raise the volume level excessively when using headphones.

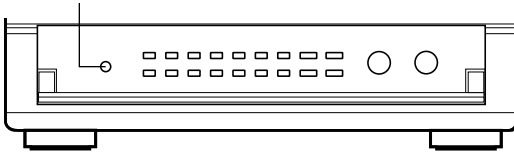

[3] Turning the sound off temporarily (muting)

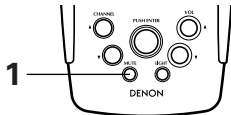

1 Use this to turn off the audio output temporarily. Press the MUTE button.

- ✳ Cancelling MUTING mode. Press the MUTE button again.



[4] Combining the currently playing sound with the desired image

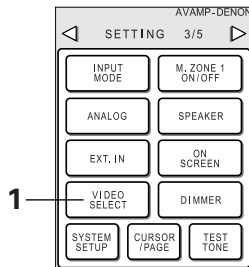

1 Simulcast playback Use this switch to monitor a video source other than the audio source. Press the remote control unit's VIDEO SELECT button until the desired image appears.

- ✳ Cancelling simulcast playback.
- Select "SOURCE" using the video select button.
- Switch the program source to the component connected to the video input.

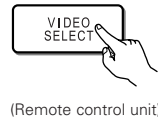

[5] Checking the currently playing program source, etc.

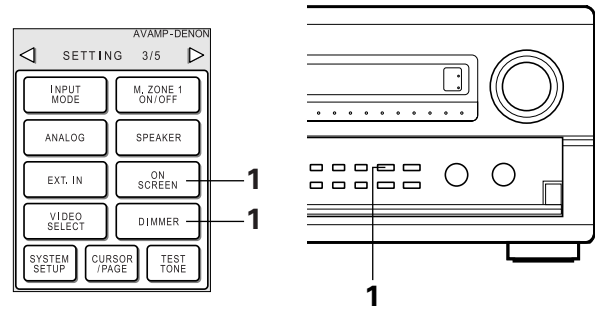

1 On screen display

- Each time an operation is performed, a description of that operation appears on the display connected to the unit's VIDEO MONITOR OUT jack. Also, the unit's operating status can be checked during playback by pressing the remote control unit's ON SCREEN button. Such information as the position of the input selector and the surround parameter settings is output in sequence.

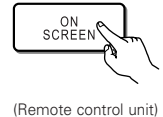

Front panel display

- Descriptions of the unit's operations are also displayed on the front panel display. In addition, the display can be switched to check the unit's operating status while playing a source by pressing the STATUS button.

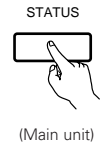

Using the dimmer function

- Use this to change the brightness of the display. The display brightness changes in four steps (bright, medium, dim and off) by pressing the remote control unit's DIMMER button repeatedly.
- ✳ The brightness changes in 3 steps each time the button is pressed, and finally the display turns off.

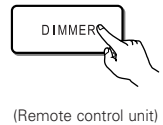

[6] Switching the surround speakers

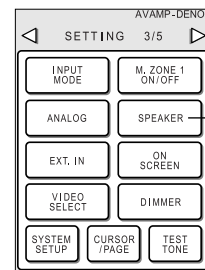

1 The surround speakers switch as shown below each time the SPEAKER button is pressed.

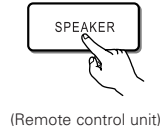
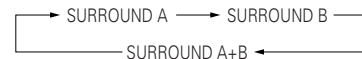

- ✳ This operation is possible when the setting for using both surround speakers A and B is made at "Speaker Configuration" in the System Setup Menu.

Multi-source recording/playback

With the exception of the case in [2] below, only the signal connected to the analog input jacks are output from the REC OUT and multi-room output jacks.

[1] Playing one source while recording another (REC OUT mode)

1 Press the REC/M-ZONE 2 button until "REC OUT SOURCE" appears on the set's display.



(Main unit)

2 Select the source you want to record appears on the set's display.

- The indicator for the selected program source lights.

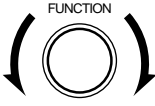

(Main unit)

3 Set the recording mode.

- For operating instructions, refer to the manual of the component on which you want to record.

4 To cancel, press the REC/M-ZONE 2 button twice.



(Main unit)

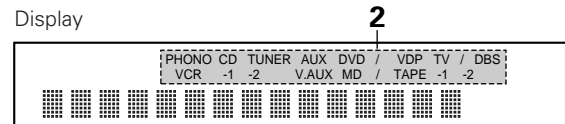
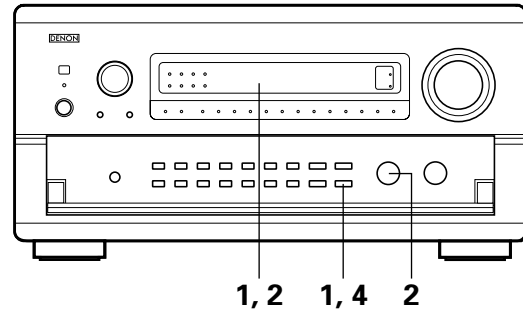

NOTES:

- Recording sources other than digital inputs selected in the REC OUT mode are also output to the multi source audio/video output jacks.
- Digital signals are not output from the MULTI ZONE 1 audio output jacks.

[2] Recording Dolby Digital and DTS multichannel sources

- With this set it is possible to record Dolby Digital and DTS multichannel signals converted into 2-channel analog signals.
- The recording signals are output to the MULTI ZONE-2 OUT, TAPE and VCR output terminals.

1 Press the REC/M-ZONE 2 button until "REC OUT SOURCE" appears on the display.



(Main unit)

2 Set the input mode according to the source to be played.



(Main unit)

3 Set the surround mode by pressing the DIRECT or STEREO button.

- The multichannel digital signals are down-mixed and output to the TAPE and VCR output terminals.

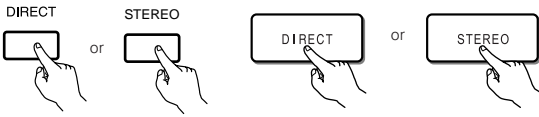

(Main unit) (Remote control unit)

4 Set the recording mode.

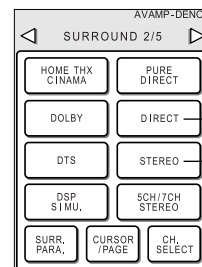
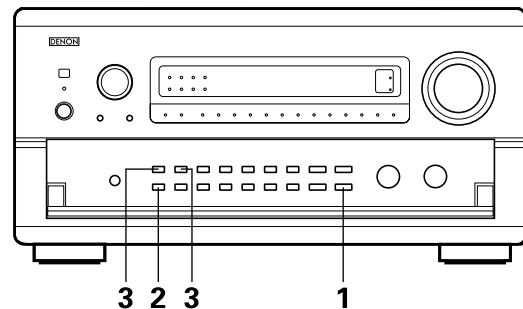

[3] Outputting a program source to an amplifier, etc., in a different room (M-ZONE 1 mode)

- 1 Press the M-ZONE 1 button.



M-ZONE 1

(Main unit)
- 2 Select the source you want to output appears on the set's display.

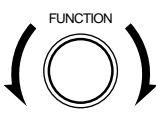

FUNCTION

(Main unit)
- 3 Start playing the source to be output.
 - For operating instructions, refer to the manuals of the respective components.

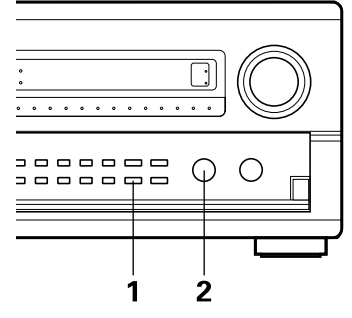
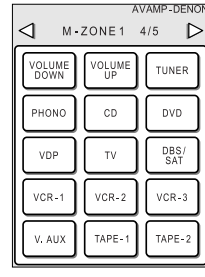

[4] Outputting a program source to an amplifier, etc., in a different room (M-ZONE 2)

- 1 Press the REC/M-ZONE 2 button until "M-ZONE 2 SOURCE" appears on the set's display.



REC / M-ZONE 2

(Main unit)
- 2 Select the source you want to record appears on the set's display.
 - The MULTI indicator lights.
 - The indicator for the selected program source light.
 - When the AVR-5800 is in the REC OUT mode, the source cannot be output using the M-ZONE 2 buttons on the remote control unit.

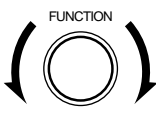

FUNCTION

(Main unit)
- 3 Start playing the source to be output.
 - For operating instructions, refer to the manuals of the respective components.

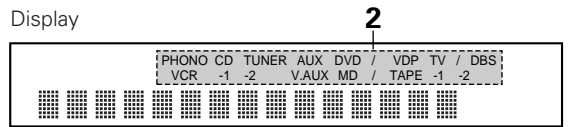
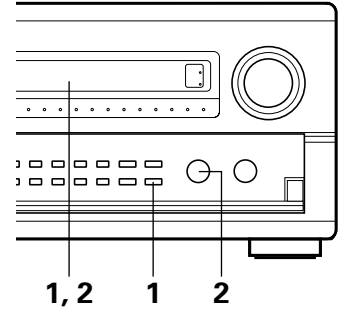
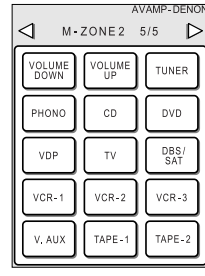

When "M-ZONE 2" is selected for the system setup's multi-zone setting, the source selected here is output from the M-ZONE 2 speaker terminals. The volume can be adjusted and the input source can be selected using the VOLUME UP and VOLUME DOWN buttons on the remote control unit's "M-ZONE 2" page.

NOTES:

- The signals of the source selected in the M-ZONE-2 mode are also output from the TAPE and VCR recording output terminals.
- Digital signals are not output from the MULTI ZONE 1 audio output jacks.

Playback using the external input (EXT. IN) jacks

- 1** Set the external input (EXT. IN) mode. Press the EXT. IN (on the EXT. IN button on the remote control unit) to switch the external input.

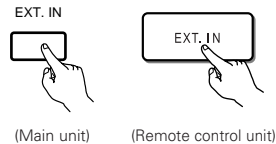

The playback switches as shown below each time the button is pressed.

EXT. IN-1 ←→ EXT. IN-2

Once this is selected, the input signals connected to the FRONT-L, FRONT-R, CENTER, SURR.-L (surround left) and SURR.-R (surround right) channels of the EXT. IN jacks are output directly to the front (left and right), center and surround (left and right) speaker systems as well as the pre-out jacks without passing through the surround circuitry.

In addition, the signal input to the SW (subwoofer) jack is output to the PRE OUT SW (subwoofer) jack.

When EXT. IN is selected, the input signals connected to the EL (effect left) and ER (effect right) jacks are output to the PRE OUT EFFECT/SB (left and right) jacks.

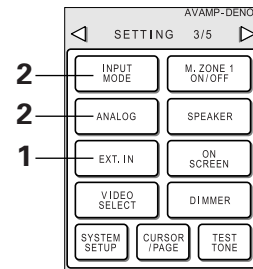
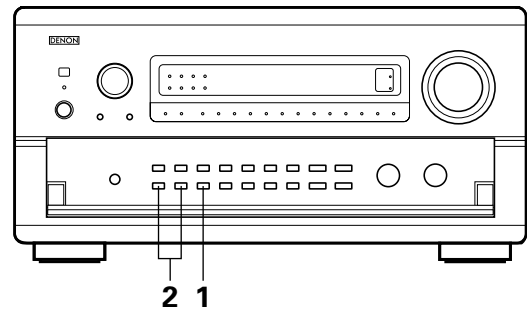

- 2** Cancelling the external input mode. To cancel the external input (EXT. IN) setting, press the INPUT MODE or ANALOG button to switch to the desired input mode.

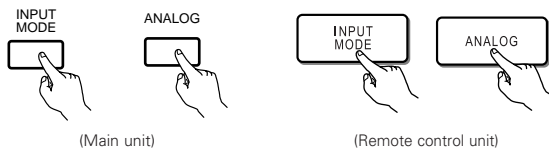

- When the input mode is set to the external input (EXT. IN), the play mode (PURE DIRECT, DIRECT, STEREO, DOLBY/DTS SURROUND, HOME THX CINEMA, WIDE SCREEN, 5CH/7CH STEREO or DSP SIMULATION) cannot be set.

NOTES:

- In play modes other than the external input mode, the signals connected to these jacks cannot be played. In addition, signals cannot be output from channels not connected to the input jacks.
- The external input mode can be set for any input source. To watch video while listening to sound, select the input source to which the video signal is connected, then set this mode.

Playing audio sources (CDs and DVDs)

The AVR-5800 is equipped with three 2-channel playback modes exclusively for music. Select the mode to suit your tastes.

1 PURE DIRECT mode

In this mode, the music is played with an extremely high level of sound quality. When this mode is set, all the video-related circuits are turned off so that music signals can be reproduced with high quality. When an analog input (phono, etc.) is selected, the digital processing circuitry is also turned off to achieve analog sound with even higher purity.



(Main unit)



(Remote control unit)

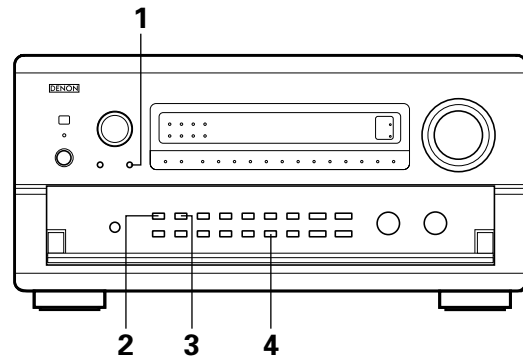

2 DIRECT mode

Use this mode to achieve good quality 2-channel sound while watching images. In this mode, the audio signals bypass such circuits as the tone circuit and are transmitted directly, resulting in good quality sound.

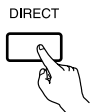

(Main unit)

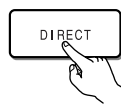

(Remote control unit)

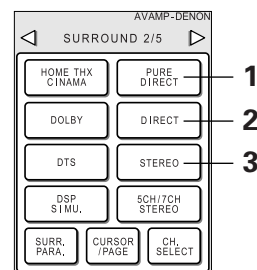

3 STEREO mode

Use this mode to adjust the tone and achieve the desired sound while watching images.



(Main unit)

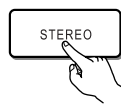

(Remote control unit)

4 VIDEO ON/OFF button

When no video signals of a DVD, etc., are connected to the AVR-5800 and the DVD, etc., are connected directly to a TV, etc., the unneeded video circuitry can be turned off by selecting the "VIDEO OFF" setting.



(Main unit)

NOTES:

- The system setup function cannot be used when the PURE DIRECT mode is set or the "VIDEO OFF" setting is selected. To use the system setup function, cancel the PURE DIRECT mode or select the "VIDEO ON" setting.
- The multi-room video output is not output in the PURE DIRECT and VIDEO OFF modes.
- The channel level and surround parameters in the PURE DIRECT mode are the same as in the DIRECT mode.
- When the PURE DIRECT button is pressed while in the PURE DIRECT mode, the PURE DIRECT mode is canceled and the DIRECT mode is set. The PURE DIRECT mode can also be canceled by turning the INPUT SELECTOR knob or pressing another surround mode button.

Multi-source and multi-zone playback

MULTI ROOM MUSIC ENTERTAINMENT SYSTEM

- When the outputs of the MULTI SOURCE AUDIO OUT terminals are wired and connected to integrated amplifiers installed in other rooms, different sources can be played in rooms other than the main room in which this unit and the playback devices are installed. (Refer to ANOTHER ROOM on the diagram below.)
- When a sold separately room-to-room remote control unit (DENON RC-616, 617 or 618) is wired and connected between the main room and another room, the remote-controllable devices in the main room can be controlled from another room using the remote control unit.
- ※ To control playback devices other than the ones above, either use that device's remote control unit or preset a separately sold programmable remote control unit.

NOTES:

- For the AUDIO output, use high quality pin-plug cords and wire in such a way that there is no humming or noise.
- For instructions on installation and operation of separately sold devices, refer to the devices' operating instructions.

MULTI ROOM MUSIC ENTERTAINMENT SYSTEM

[1] Multi-zone playback using the MULTI ZONE 1 terminals

The AVR-5800 is equipped with audio pre-out terminals for which the volume is adjustable (M-ZONE 1) and composite video output terminals as the MULTI ZONE 1 output terminals.

A separately sold stereo power amplifier (POA-T10) can be connected to enjoy multi-zone playback. Also refer to the operating instructions of the RC-8001ST.

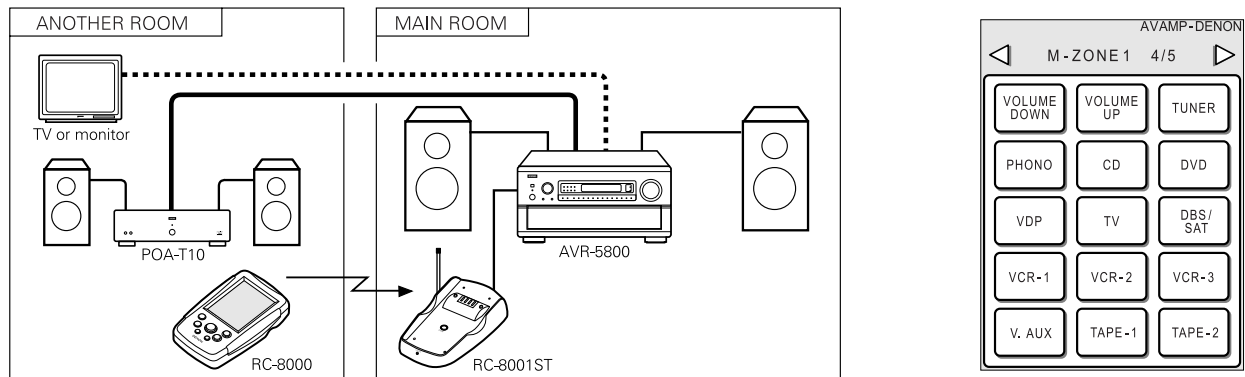

NOTE:

The multi-room video output is not output in the PURE DIRECT and VIDEO OFF modes.

When connected as shown on the diagram below using connection cords included with Denon power amplifiers, the power amplifier's power can be turned on and off using the "M-ZONE 1 ON/OFF" button on the remote control unit.

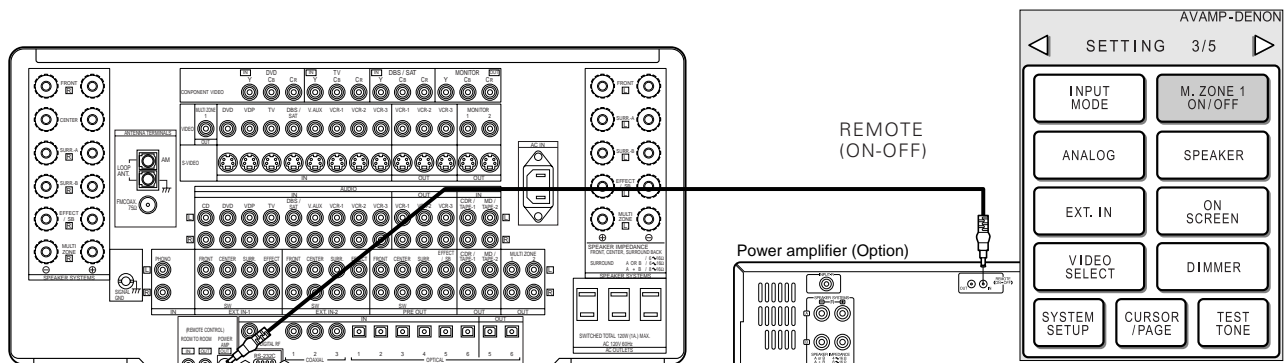

[2] Multi-zone playback using the MULTI ZONE 2 terminals

The AVR-5800 is equipped with audio pre output terminals with a fixed output level (M-ZONE 2) as the MULTI ZONE 2 output terminals. (These are not video outputs.)

Settings can be made at the system setup menu so that the same source as the M-ZONE 2 pre-out terminals can be played from the speakers connected to the M-ZONE 2 speaker terminals.

■ When using the PRE OUT terminals

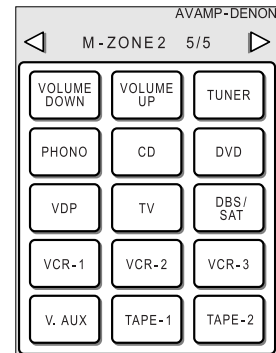
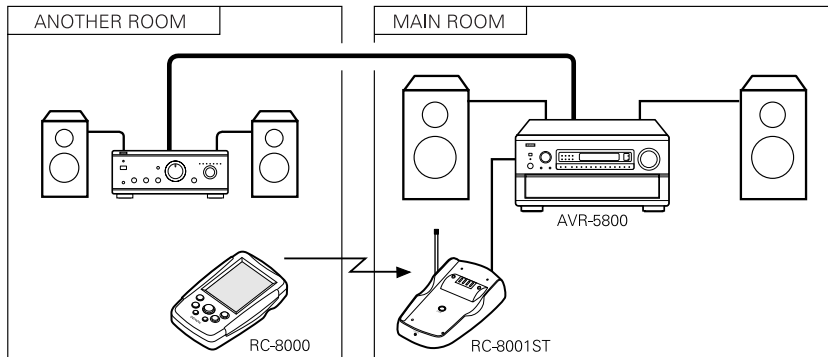

■ When using the M-ZONE 2 (MULTI) speaker terminals

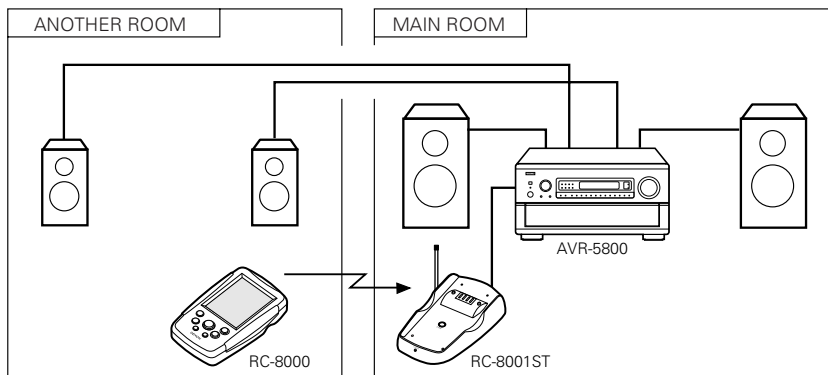

NOTE:

When the main unit is set to the recording output mode, the M-ZONE 2 remote control unit key cannot be operated. (See page 36.)

[3] When using a separately sold room-to-room remote control unit (RC-616, 617 or 618)

When the main room and another room are far apart and operation is not possible with RF transmission, operation is possible using a separately sold room-to-room remote control unit (RC-616, 617 or 618).

For details, refer to the operating instructions of the RC-616, 617 or 618.

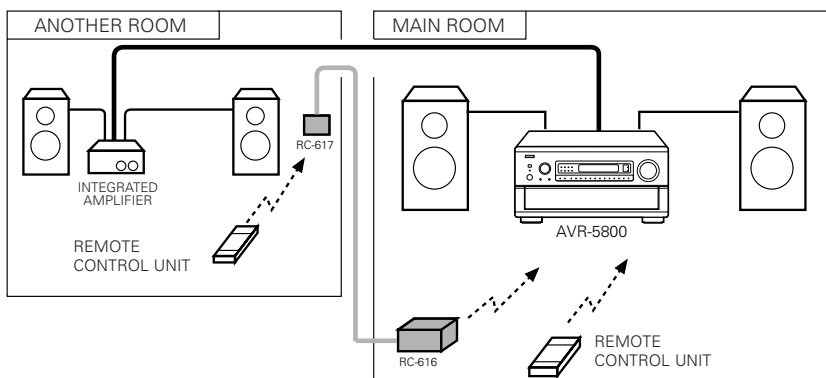

- ROOM-TO-ROOM REMOTE CONTROL SYSTEM (separately sold) control line
- MULTI SOURCE AUDIO signal cable
- SPEAKER cable

10 SURROUND

Before playing with the surround function

- Before playing with the surround function, be sure to use the test tones to adjust the playback level from the different speakers. This adjustment can be performed with the system setup (see page 25) or from the remote control unit, as described below.
- Adjusting with the remote control unit using the test tones is only possible in the "Auto" mode and only effective in the DOLBY SURROUND and HOME THX CINEMA modes. The adjusted levels for the different modes are automatically stored in the memory.

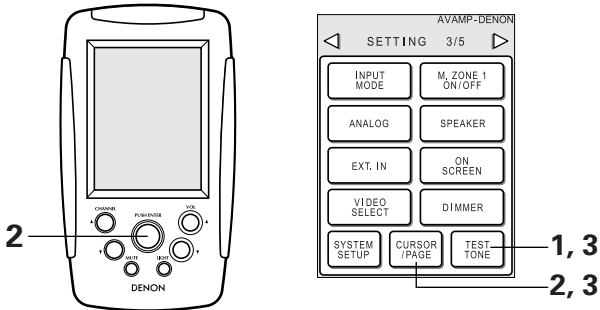

1 Press the TEST TONE button.



2 Test tones are output from the different speakers. Press the CURSOR/PAGE button to highlight the display, then use the jog stick to adjust the channel level.

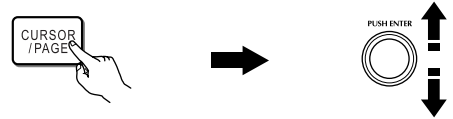

3 After completing the adjustment, press the CURSOR/PAGE button again so that the display is no longer highlighted, then press the TEST TONE button to complete the operation.



- After adjusting using the test tones, make the desired settings for each surround mode to be played, then use the procedure described below to adjust the levels of the various channels.

1 MAIN UNIT:
Press the MODE SELECT button and select "CH VOL".



The setting mode switches in the following order each time the button is pressed:



(Main unit)

REMOTE CONTROL UNIT:
Press the CH. SELECT button on the "SURROUND 2/5" page. "CH VOL" is selected.



(Remote control unit)

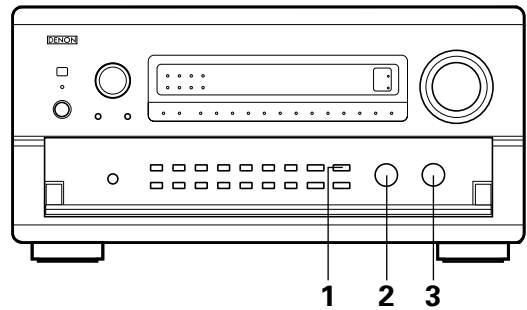

2 MAIN UNIT:
Use the FUNCTION knob to select the speaker whose level is to be adjusted.

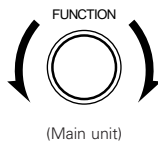

(Main unit)

REMOTE CONTROL UNIT:
Press the CURSOR/PAGE button on the "SURROUND 2/5" page to highlight the display, then press jog stick "ENTER". The channel (speaker) switches as shown on the diagram below each time it is pressed.



(Remote control unit)

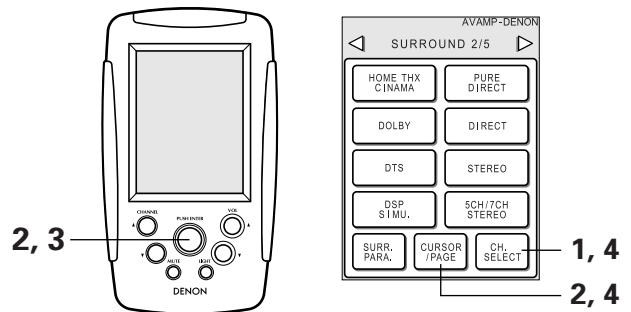
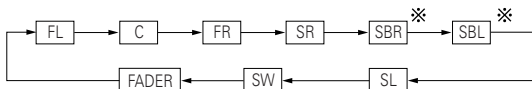

3 MAIN UNIT:
Turn the CONTROL knob to adjust the level of the selected speaker.

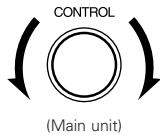

REMOTE CONTROL UNIT:
Move jog stick "ENTER" back and forth to adjust the level of the selected speaker.

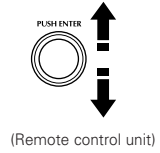

4 REMOTE CONTROL UNIT:
Once the channel level adjustment is completed, press the CURSOR/PAGE button again so that the display is no longer highlighted, then press the CH. SELECT button.

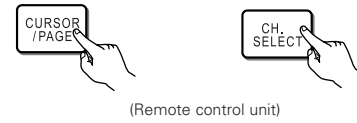

※ When the surround back speaker setting is set to "1spkr" for "Speaker Configuration", this is set to "SB".
In the EXT IN mode, "SBR" is set to "ER", "SBL" to "EL".

Fader function

• This function makes it possible to lower the volume of the front channels (FL, C and FR) or the rear channels (SL, SR, SBL and SBR) together. Use it for example to adjust the balance of the sound from the different positions when playing multi-channel music sources.

1 MAIN UNIT:
Select "FADER" using the FUNCTION knob after selecting "CH. VOL" with the MODE SELECT button.

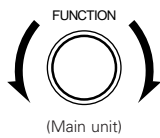

REMOTE CONTROL UNIT:
Select "FADER".

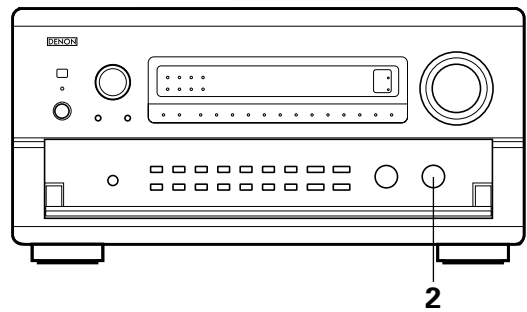
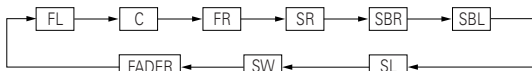
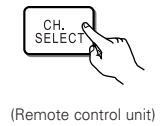

2 MAIN UNIT:
Turn the CONTROL knob clockwise to adjust the volume of the surround side collectively. Turn the CONTROL knob counterclockwise to adjust the volume of the front side collectively.

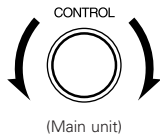

REMOTE CONTROL UNIT:
Move jog stick "ENTER" to the top side to adjust the volume of the surround side collectively.
Move jog stick "ENTER" to the bottom side to adjust the volume of the front side collectively.

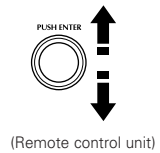

※ The fader function does not affect the SW, EL and ER channels.

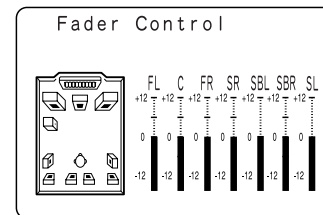
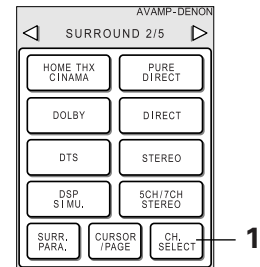
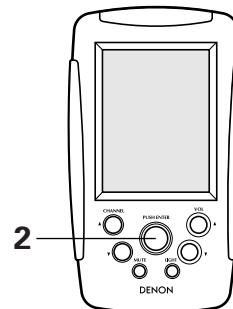

This is only displayed when setting the fader control.

※ The channel whose channel level is adjusted lowest can be faded to -12 dB using the fader function.

※ If the channel levels are adjusted separately after adjusting the fader, the fader adjustment values are cleared, so adjust the fader again.

Playing modes for different sources

The AVR-5800 is equipped with many surround modes. We recommend using the surround modes as described below in order to achieve the maximum effect for the specific signal source.

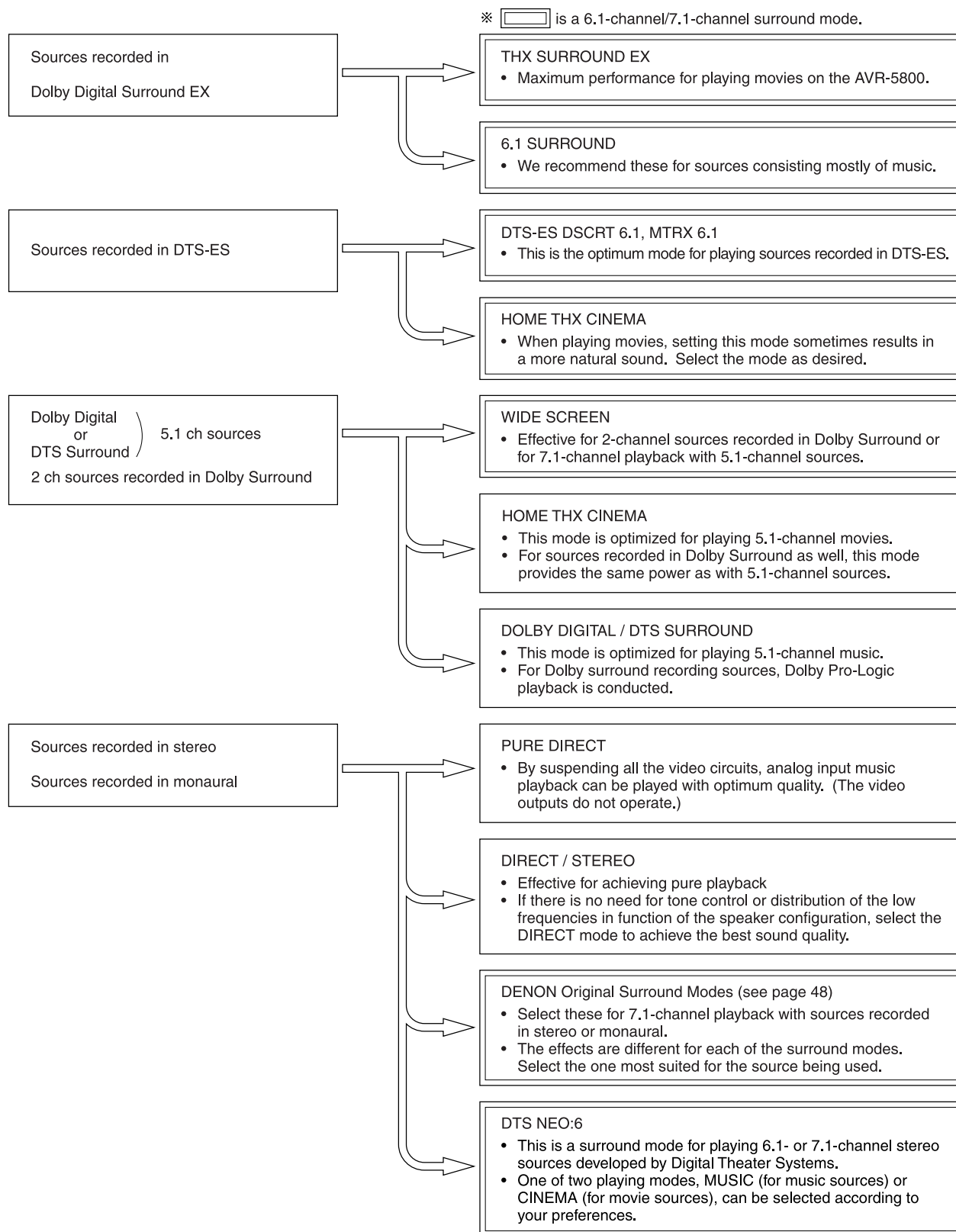

• Though we recommend selecting the surround mode as described above, other surround modes can also be selected.

THX Surround EX / Home THX Cinema mode

When the HOME THX CINEMA button is pressed, the surround mode is set as follows according to the signal that is played:

- ❶ THX Surround EX
- ❷ Home THX CINEMA
- ❸ THX 5.1

When the HOME THX CINEMA mode is set when a DVD is played, check the DVD player's digital output setting and change the setting to one for which Dolby Digital and DTS bit stream signals can be output ("bit stream", for example).

When the THX5.1 mode is set, press the 6.1/7.1 SURROUND button and change the parameter's setting to "ON".

[1] Playing sources recorded in Dolby Pro Logic in the Home THX Cinema surround mode

- ❶ Select the Home THX Cinema mode.

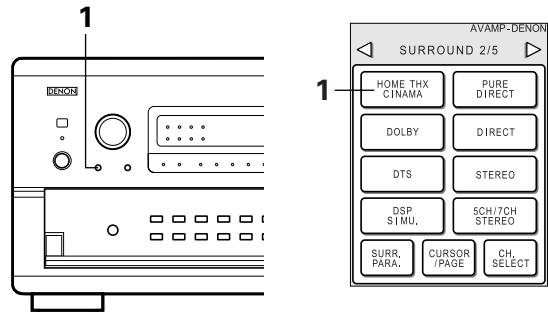
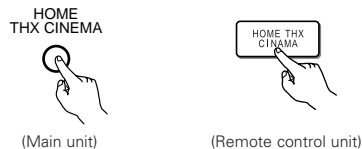

- ❷ Play a program source with the **DOLBY SURROUND** mark.
 - For operating instructions, refer to the manuals of the respective components.

[2] To play in the THX Surround EX/Home THX Cinema Surround mode for sources recorded in Dolby Digital or DTS

- ❶ Select the program source.

Selecting a digital input source

 Perform step 1 under "Dolby Digital mode and DTS Surround" (page 46).

- ❷ Select the Home THX Cinema mode.

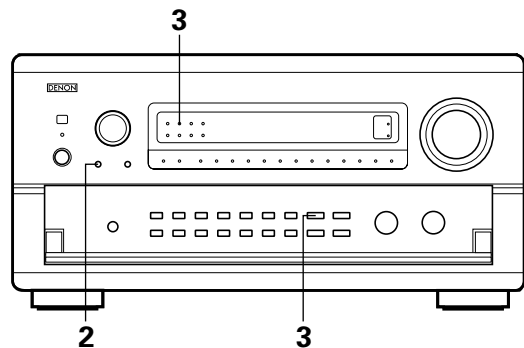
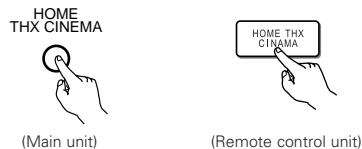

- ❸ Play a program source with the **DOLBY DIGITAL** , **dts** mark.

For operating instructions, refer to the manuals of the respective components.

The channel status information during playback of Dolby Digital and DTS sources can be checked using the "STATUS" button on the main unit.

SURROUND BACK CH. OUTPUT The surround back LED lights green when playing in the THX SURROUND EX mode.

DOLBY DIGITAL The Dolby Digital indicator lights when playing Dolby Digital sources.

DTS When playing DTS sources, the DTS indicator lights.

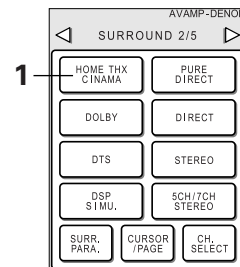

Surround parameters ❶

AFDM (Auto Flag Detect Mode):

Select the Auto Flag Detect Mode. (See page 21.)

SB CH OUT:

When Auto Flag Detect Mode is set to "OFF", the reproduction method of a surround back channel can be chosen.

The parameter which can be chosen is equivalent to the contents of a setting of Non Flag Source SBch Output (see page 21).

When Auto Flag Detect Mode is set to "ON", the parameter selected by Non Flag Source SBch Output of Setup Menu is displayed (see page 21).

When you change a parameter, please set Auto Flag Detect Mode to OFF.

Dolby Digital mode (only with digital input) and DTS Surround (only with digital input)

1 Select the input source.

Playback with digital input

1 Select an input source set to digital (COAXIAL/OPTICAL) (see page 28).

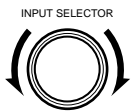

(Main unit)



(Remote control unit)

2 Set the input mode to "AUTO".

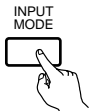

(Main unit)

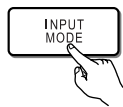

(Remote control unit)

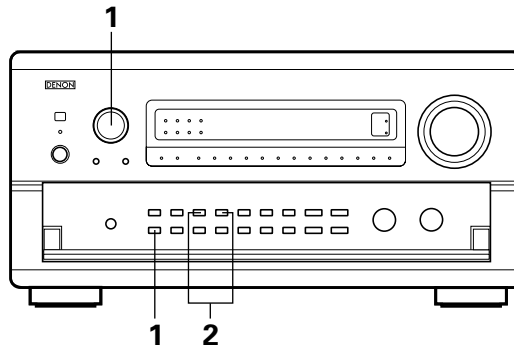

2 Select the Surround mode.

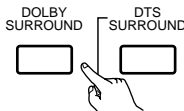

(Main unit)

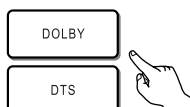

(Remote control unit)

3 Play a program source with the , mark.

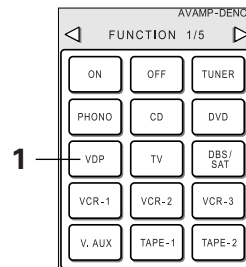

1

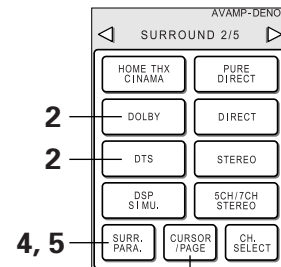

2

2

4, 5

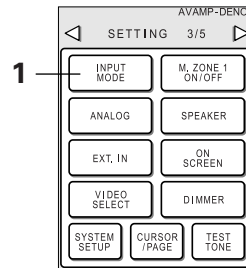

1

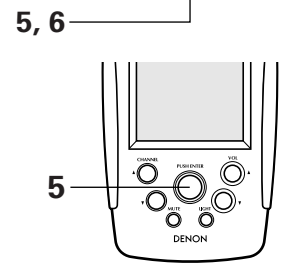

5

5, 6

4 Display the surround parameter menu.



(Remote control unit)

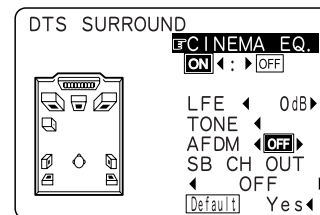
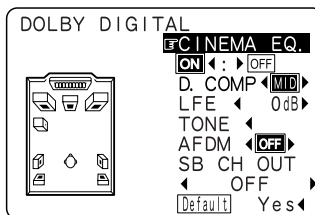

5 Press the CURSOR/PAGE button to highlight the display, then use the jog stick to set the parameters.

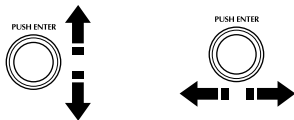

(Remote control unit)

6 Press the CURSOR/PAGE button so that the display is no longer highlighted, then press the "SURR. PARA" button to complete the setting.



(Remote control unit)

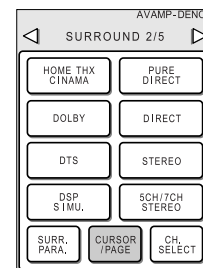

NOTE:

- When "Default" is selected and the jog stick is moved to the left, "CINEMA EQ." and "D.COMP." are automatically turned off, "SB CH OUT" is reset, "CHANNEL LEVEL" and the tone is set to the default value.

Surround parameters ②

CINEMA EQ. (Cinema Equalizer):

The Cinema EQ function gently decreases the level of the extreme high frequencies, compensating for overly-bright sounding motion picture soundtracks. Select this function if the sound from the front speakers is too bright.

This function only works in the Dolby Pro Logic, Dolby Digital, DTS Surround and Wide Screen modes.

D.COMP. (Dynamic Range Compression):

Motion picture soundtracks have tremendous dynamic range (the contrast between very soft and very loud sounds). For listening late at night, or whenever the maximum sound level is lower than usual, the Dynamic Range Compression allows you to hear all of the sounds in the soundtrack (but with reduced dynamic range). (This only works when playing program sources recorded in Dolby Digital or DTS.) Select one of the four parameters ("OFF", "LOW", "MID" (middle) or "HI" (high)). Set to OFF for normal listening.

This parameter is displayed only when playing compatible sources in DTS mode.

LFE (Low frequency Effect):

This sets the level of the LFE (Low Frequency Effect) sounds included in the source when playing program sources recorded in Dolby Digital or DTS.

If the sound produced from the subwoofer sounds distorted due to the LFE signals when playing Dolby Digital or DTS sources when the peak limiter is turned off with the subwoofer peak limit level setting (system setup menu), adjust the level as necessary.

Program source and adjustment range

1. Dolby Digital:-10 dB to 0 dB
2. DTS Surround:-10 dB to 0 dB

※ **When DTS encoded movie software is played, it is recommended that the LFE LEVEL be set to 0 dB for correct DTS playback.**

※ **When DTS encoded music software is played, it is recommended that the LFE LEVEL be set to -10 dB for correct DTS playback.**

tone:

This adjusts the tone control. (See "Surround parameters ③" on page 50.)

■ Dialogue Normalization

The dialogue normalization function is activated automatically when playing Dolby Digital program sources.

Dialogue normalization is a basic function of Dolby Digital which automatically normalizes the dialog level (standard level) of the signals which are recorded at different levels for different program sources, such as DVD, DTV and other future formats that will use Dolby Digital.

When this function is activated, the following message appears on the main unit's display:

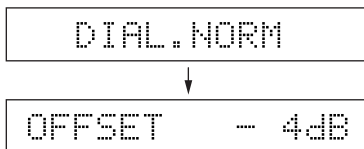

The number indicates the normalization level when the currently playing program is normalized to the standard level.

Dolby Surround Pro Logic mode

- 1 Select the Dolby Surround Pro Logic mode.
 - The Dolby Pro Logic indicator lights.

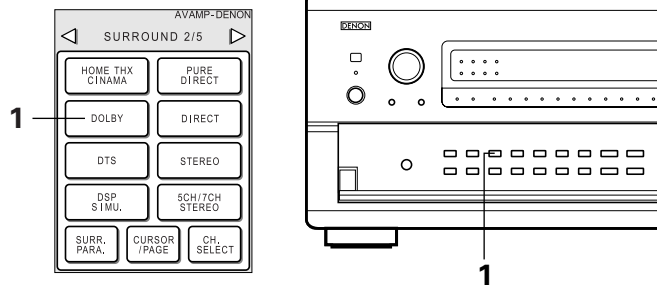
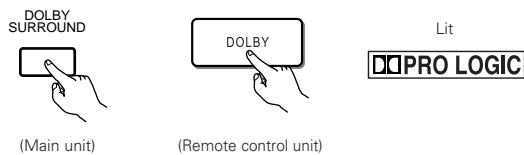

- 2 Play a program source with the **DD DOLBY SURROUND** mark.
 - For operating instructions, refer to the manuals of the respective components.

NOTE:

- There are four Dolby Surround Pro Logic modes (NORMAL, PHANTOM, WIDE and 3CH. LOGIC). The AVR-5800 sets the mode automatically according to the types of speakers set during the system setup process (page 19).

DTS Neo:6 mode

Surround playback can be conducted for the analog input and PCM digital input 2-channel signals.

- 1 Select the DTS surround mode.
 - Select CINEMA or MUSIC. (CINEMA is optimum for movies, MUSIC is optimum for music software.)

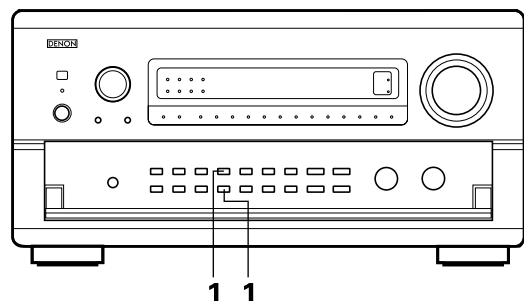
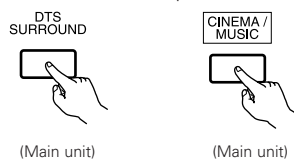

11 DENON ORIGINAL SURROUND MODES

- The AVR-5800 is equipped with a built-in high performance DSP (digital signal processor) that uses digital processing to recreate sound fields artificially. Select one of the eight provided surround modes according to the program source you want to play and adjust the parameters to achieve a more real, powerful sound field.

Surround modes and their features

1	WIDE SCREEN	Select this to achieve an atmosphere like that of a movie theater with a large screen. In this mode, all signal sources are played in the 7.1-channel mode, including Dolby Pro Logic and Dolby Digital 5.1-channel sources. Effects simulating the multi surround speakers of movie theaters are added to the surround channels.
2	SUPER STADIUM	Select this when watching baseball or soccer programs to achieve a sound as if you were actually at the stadium. This mode provides the longest reverberation signals.
3	ROCK ARENA	Use this mode to achieve the feeling of a live concert in an arena with reflected sounds coming from all directions.
4	JAZZ CLUB	This mode creates the sound field of a live house with a low ceiling and hard walls. This mode gives jazz a very vivid realism.
5	CLASSIC CONCERT	Select this for the sound of a concert hall rich in reverberations.
6	MONO MOVIE (NOTE 1)	Select this when watching monaural movies for a greater sense of expansion.
7	MATRIX	Select this to emphasize the sense of expansion for music sources recorded in stereo. Signals consisting of the difference component of the input signals (the component that provides the sense of expansion) processed for delay are output from the surround channel.
8	5CH/7CH STEREO	The front left channel signals are output to the surround and surround back signal left channels, the front right channel signals are output to the surround and surround back signal right channels, and the in-phase component of the left and right channels is output to the center channel. Use this mode to enjoy stereo sound.

※ Depending on the program source being played, the effect may not be very noticeable.
In this case, try other surround modes, without worrying about their names, to create a sound field suited to your tastes.

NOTE 1: When playing sources recorded in monaural, the sound will be one-sided if signals are only input to one channel (left or right), so input signals to both channels. If you have a source component with only one audio output (monophonic camcorder, etc.) obtain a "Y" adaptor cable to split the mono output to two outputs, and connect to the L and R inputs.

NOTE:

PURE DIRECT, DIRECT and 5CH/7CH STEREO modes can be used when playing PCM signals with a sampling frequency of 96 kHz (such as from DVD-Video discs that contain 24 bit, 96 kHz audio). If such signals are input during playback in one of the other surround modes, the mode automatically switches to DIRECT.

Personal Memory Plus

This set is equipped with a personal memorize function that automatically memorizes the surround modes and input modes selected for the input different sources. When the input source is switched, the modes set for that source last time it was used are automatically recalled.

* The surround parameters, tone control settings and playback level balance for the different output channels are memorized for each surround mode.

DSP surround simulation

1 Select the surround mode for the input channel.

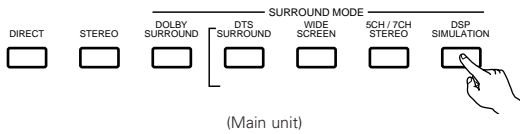

The surround mode switches in the following order each time the DSP SIMULATION button is pressed:

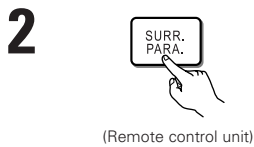
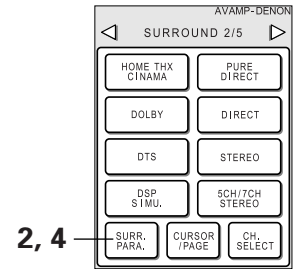
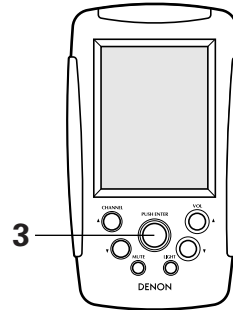
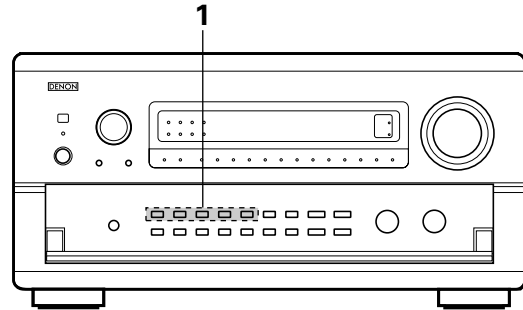
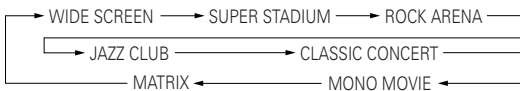

Display the surround parameter screen on the monitor.
 ※ The screen for the selected surround mode appears.

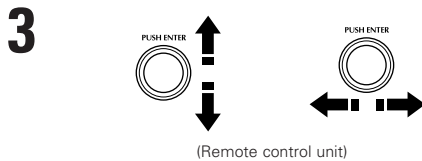
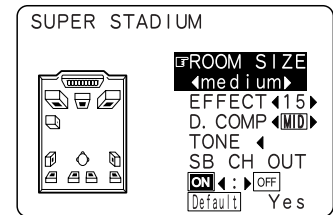

Press the CURSOR/PAGE button to highlight the display, then use the jog stick to set the parameters.

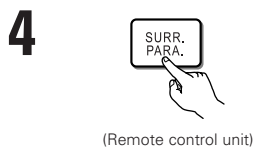
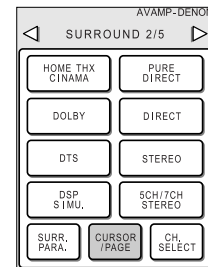

Press the CURSOR/PAGE button so that the display is no longer highlighted, then press the "SURR. PARA" button to complete the setting.

NOTES:

- When "Default" is selected and the jog stick is moved to the left, "CINEMA EQ." and "D. COMP." are automatically set to "OFF". In addition, "ROOM SIZE" is set to "medium", "EFFECT LEVEL" to "10" and "DELAY TIME" to "30ms".
- The "ROOM SIZE" expresses the expansion effect for the different surround modes in terms of the size of the sound field, not the actual size of the listening room.

Tone control setting

- Use the tone control setting to adjust the bass and treble as desired.

1



(Remote control unit)

Display the surround parameter screen on the monitor.
 ※ The screen for the selected surround mode appears.
 “TONE” cannot be selected in the Direct or Home THX Cinema mode.

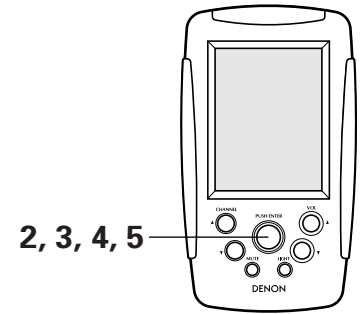
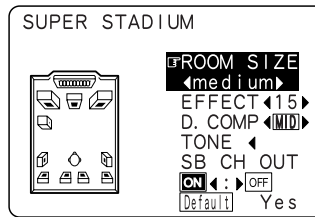

2



(Remote control unit)

Press the CURSOR/PAGE button to highlight the display, then use the jog stick to set the parameters. Select “TONE”.

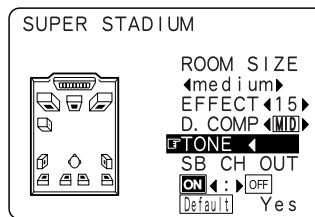

3



(Remote control unit)

Switch to the Tone Control screen.

Total Control

Tone Defeat ON OFF

Bass ← -6dB →

Treble ← +10dB →

Individual Control

Front Bass ← +10dB →

 Treble +10dB

Center Bass +10dB

 Treble +10dB

Surround Bass +10dB

 Treble +10dB

SurroundBack Bass +10dB

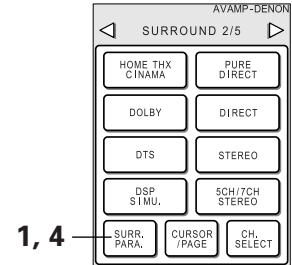

 Treble +10dB

Subwoofer Bass +10dB

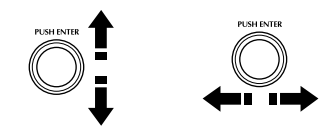

4

Ⓞ To select Bass or Treble. Ⓞ To set the level. ※ If you do not want the tone to be adjusted, set “Tone Defeat” to “ON”. (See page 35.)

(Remote control unit)

5



(Remote control unit)

Enter the setting.
 The surround menu screen re-appears.

6



(Remote control unit)

Press the CURSOR/PAGE button so that the display is no longer highlighted, then press the “SURR. PARA.” button to complete the setting.

Surround parameters ③

EFFECT:

This parameter turns the effect signals with multi surround mode speaker effects on and off in the WIDE SCREEN mode. When this parameter is turned off, the SBL and SBR channel signals are equivalent to the SL and SR channels, respectively.

LEVEL:

This parameter sets the strength of the effect signals in the WIDE SCREEN mode. It can be set in 15 steps, from "1" to "15". Set this to a low level if the positioning or phase of the surround signals sounds unnatural.

SB CH OUT:

(1) Dolby Digital/DTS source

"OFF"Playback is conducted without using the surround back speaker.

"NON MTRX"Playback is conducted using the surround back speaker.

The same signals those of the surround channels are output from the surround back channels.

"MTRX ON"Playback is conducted using the surround back speaker.

Surround back channel is reproduced using digital matrix processing.

(2) Other source

"OFF"Playback is conducted without using the surround back speaker.

"ON"Playback is conducted using the surround back speaker.

NOTE: This operation can be performed directly using the "6.1/7.1 Surround" button on the main unit's panel.

ROOM SIZE:

This sets the size of the sound field.

There are five settings: "small", "med.s" (medium-small), "medium", "med.l" (medium-large) and "large". "small" recreates a small sound field, "large" a large sound field.

EFFECT LEVEL:

This sets the strength of the surround effect.

The level can be set in 15 steps from 1 to 15. Lower the level if the sound seems distorted.

DELAY TIME:

In the matrix mode only, the delay time can be set within the range of 0 to 300 ms.

tone CONTROL:

This can be set individually for the separate surround modes other than Direct and Home THX Cinema.

■ Surround modes and parameters

Mode	Signals and adjustability in the different modes														
	Channel output					Parameter (default values are shown in parentheses)								When playing Dolby Digital and DTS signals	
	FRONT L/R	CENTER	SURROUND L/R	SURROUND BACK /EFFECT L/R	SUB-WOOFER	tone CONTROL	CINEMA EQ.	EFFECT	LEVEL	ROOM SIZE	EFFECT LEVEL	DELAY TIME	D.COMP.	AFDM	SB CH OUT
PURE DIRECT, DIRECT	○	×	×	×	⊙	×	×	×	×	×	×	×	○ (OFF)	×	×
STEREO	○	×	×	×	⊙	○ (0dB)	×	×	×	×	×	×	○ (OFF)	×	×
EXTERNAL INPUT	○	⊙	⊙	⊙	⊙	○ (0dB)	×	×	×	×	×	×	×	×	×
WIDE SCREEN	○	⊙	⊙	⊙	⊙	○ (0dB)	○ (OFF)	○ (ON)	○ (10)	×	×	×	○ (OFF)	×	○
HOME THX CINEMA	○	⊙	⊙	⊙	⊙	×	×	×	×	×	×	×	○ (OFF)	○	○
DOLBY PRO LOGIC	○	⊙	⊙	⊙	⊙	○ (0dB)	○ (OFF)	×	×	×	×	×	○ (OFF)	○	○
DOLBY DIGITAL	○	⊙	⊙	⊙	⊙	○ (0dB)	○ (OFF)	×	×	×	×	×	○ (OFF)	○	○
DTS SURROUND	○	⊙	⊙	⊙	⊙	○ (0dB)	○ (OFF)	×	×	×	×	×	○ (OFF)	○	○
DTS STEREO SURROUND	○	⊙	⊙	⊙	⊙	○ (0dB)	×	×	×	×	×	×	×	○	○
5CH/7CH STEREO	○	⊙	⊙	⊙	⊙	○ (0dB)	×	×	×	×	×	×	○ (OFF)	×	○
SUPER STADIUM	○	⊙	⊙	⊙	⊙	○ (note 1)	×	×	×	○ (Medium)	○ (10)	×	○ (OFF)	×	○
ROCK ARENA	○	⊙	⊙	⊙	⊙	○ (note 2)	×	×	×	○ (Medium)	○ (10)	×	○ (OFF)	×	○
JAZZ CLUB	○	⊙	⊙	⊙	⊙	○ (0dB)	×	×	×	○ (Medium)	○ (10)	×	○ (OFF)	×	○
CLASSIC CONCERT	○	⊙	⊙	⊙	⊙	○ (0dB)	×	×	×	○ (Medium)	○ (10)	×	○ (OFF)	×	○
MONO MOVIE	○	⊙	⊙	⊙	⊙	○ (0dB)	×	×	×	○ (Medium)	○ (10)	×	○ (OFF)	×	○
MATRIX	○	⊙	⊙	⊙	⊙	○ (0dB)	×	×	×	×	×	○ (30msec)	○ (OFF)	×	○

○ : Signal/adjustable

(Note 1) BASS: +6dB, TREBLE: 0dB

(Note 2) BASS: +8dB, TREBLE: +4dB

⊙ : Turned on or off by speaker configuration setting

× : No signal/not adjustable

12 LISTENING TO THE RADIO

To operate the tuner by remote control, switch the remote control device to "TUNER".

Auto tuning

- 1** Set the input function to "TUNER".



- 2** Watching the display, press the BAND button to select the desired band (AM or FM).

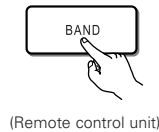

- 3** Press the MODE button to set the auto tuning mode.

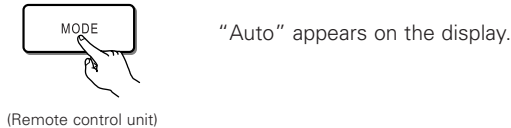

- 4** Press the TUNING UP or DOWN button.

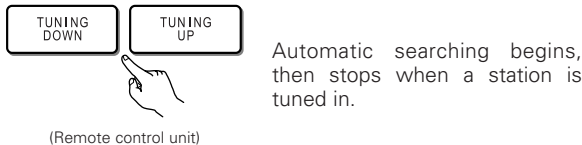

If tuning does not stop at the desired station, use to the "Manual tuning" operation.

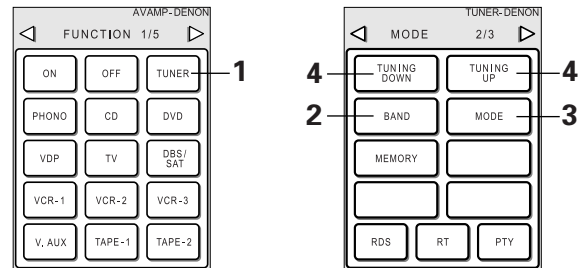
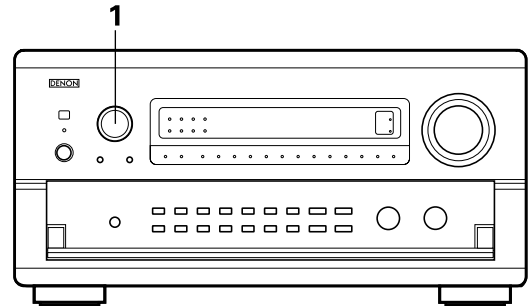

Manual tuning

- 1** Set the input function to "TUNER".



- 2** Switch the remote control device to "TUNER". Watching the display, press the BAND button to select the desired band (AM or FM).

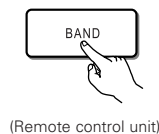

- 3** Press the MODE button to set the manual tuning mode. Check that the display's "AUTO" indicator turns.

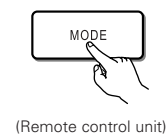

- 4** Press the TUNING UP or DOWN button to tune in the desired station. The frequency changes continuously when the button is held in.

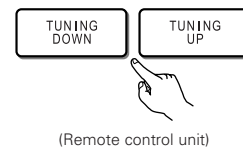

NOTES:

- When in the auto tuning mode on the FM band, the "STEREO" indicator lights on the display when a stereo broadcast is tuned in. At open frequencies, the noise is muted and the "TUNED" and "STEREO" indicators turn off.
- When the manual tuning mode is set, FM stereo broadcasts are received in monaural and the "STEREO" indicator turns off.

Preset memory

1 Use the "Auto tuning" or "Manual tuning" operation to tune in the station to be preset in the memory.

2 Press the MEMORY button.

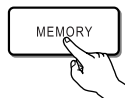

(Remote control unit)

3 **Main unit:** Press the MODE SELECT button until "TUNER PRESET" appears on the set's display.

Remote control unit:

Press the SHIFT button and select the desired memory block (A to E).

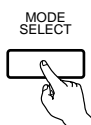

(Main unit)



(Remote control unit)

4 **Main unit:** Select the desired preset channel (1 to 8).

Remote control unit:

Press the PRESET UP or DOWN button to select the desired preset channel (1 to 8).

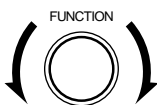

(Main unit)

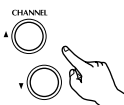

(Remote control unit)

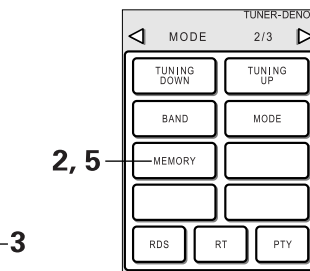
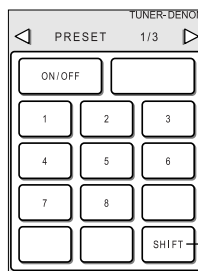
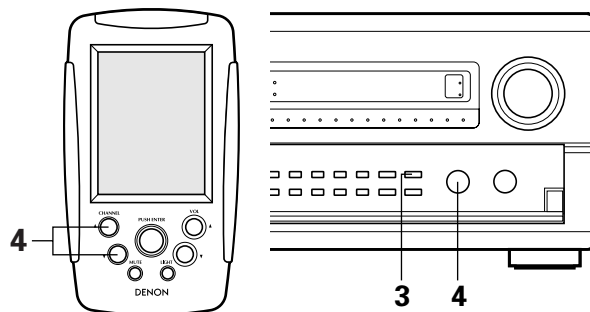

5 Press the MEMORY button again to store the station in the preset memory.

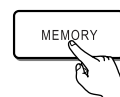

(Remote control unit)

To preset other channels, repeat steps 2 to 5. A total of 40 broadcast stations can be preset — 8 stations (channels 1 to 8) in each of blocks A to E.

Checking the preset stations

The preset broadcast stations can be checked on the on screen display.

1 Press the ON SCREEN button repeatedly until the "Tuner Preset Stations" screen appears on the on screen display.

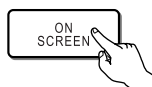

(Remote control unit)

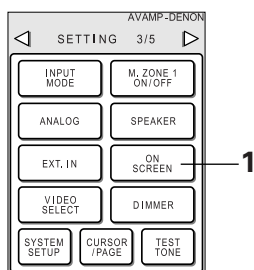

Tuner Preset Stations	
A1FM	87.50MHz
A2FM	89.10MHz
A3FM	98.10MHz
A4FM	107.90MHz
A5FM	90.10MHz
A6FM	90.10MHz
A7FM	90.10MHz
A8FM	90.10MHz

OSD-8

Recalling preset stations

- 1 Main unit:**
Watching the display, press the MODE SELECT button until "TUNER PRESET" appears on the set's display.

Remote control unit:
Watching the display, press the SHIFT button to select the preset memory block.

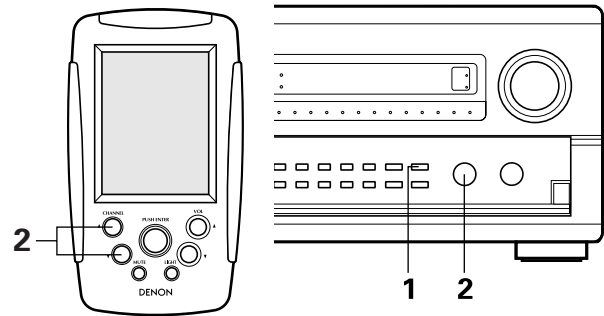
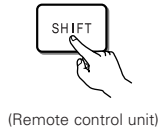
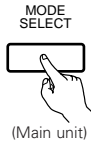

- 2 Main unit:**
Watching the display, select the desired preset channel.

Remote control unit:
Watching the display, press the PRESET UP or DOWN button to select the desired preset channel.

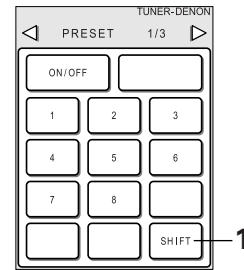
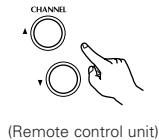
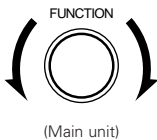

13 LAST FUNCTION MEMORY

- This unit is equipped with a last function memory which stores the input and output setting conditions as they were immediately before the power is switched off. This function eliminates the need to perform complicated resettings when the power is switched on.
- The unit is also equipped with a back-up memory. This function provides approximately one week of memory storage when the main unit's power switch is off and with the power cord disconnected.

14 INITIALIZATION OF THE MICROPROCESSOR

When the indication of the display is not normal or when the operation of the unit does not shows the reasonable result, the initialization of the microprocessor is required by the following procedure.

- Switch off the unit and remove the AC cord from the wall outlet.
- Press and hold the DIRECT buttons and STEREO buttons, and at the same time, plug in the AC cord.
- Check that the entire display is flashing with an interval of about 1 second, and release your fingers from the 2 buttons and the microprocessor will be initialized.

NOTES:

- If step 3 does not work, start over from step 1.
- If the microprocessor has been reset, all the button settings are reset to the default values (the values set upon shipment from the factory).

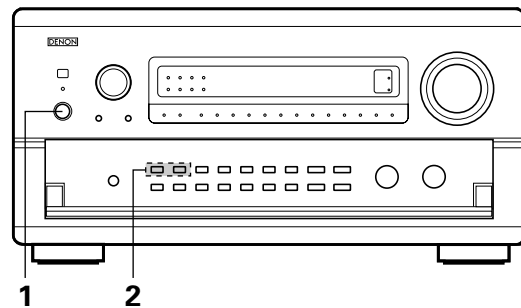

15 TROUBLESHOOTING

If a problem should arise, first check the following.

1. Are the connections correct ?
2. Have you operated the receiver according to the Operating Instructions ?
3. Are the speakers, turntable and other components operating properly ?

If this unit is not operating properly, check the items listed in the table below. Should the problem persist, there may be a malfunction. Disconnect the power immediately and contact your store of purchase.

Symptom	Cause	Measures	Page
DISPLAY not lit and sound not produced when power switch set to on.	<ul style="list-style-type: none"> • Power cord not plugged in securely. 	<ul style="list-style-type: none"> • Check the insertion of the power cord plug. 	6
DISPLAY lit but sound not produced.	<ul style="list-style-type: none"> • Speaker cords not securely connected. • Input source selector button position is not appropriate. • Volume control set to minimum. • MUTING is on. • No digital signal is being input. • Speaker A or B button is set to "OFF". 	<ul style="list-style-type: none"> • Connect securely. • Switch to the proper position. • Turn volume up to suitable level. • Switch off MUTING. • Properly select a digital signal input source. • Set the button for the connected speaker terminals to "ON". 	12, 13 33 34 35 28 19
Nothing is displayed on monitor.	<ul style="list-style-type: none"> • AVR-5800's video output jacks and monitor's input jacks are not properly connected. • Monitor TV's input setting is wrong. • Connections of the various component's video signals are not unified. 	<ul style="list-style-type: none"> • Check that the connections are correct. • Set the TV's input selector to the jacks to which video signals are connected. • Unify to composite or S jack. 	7 ~ 9 7 ~ 9 7 ~ 9
No dts sound is produced.	<ul style="list-style-type: none"> • DVD player's audio output setting is not set to bit stream. • DVD player is not dts-compatible. • AVR-5800's input setting is set to analog. 	<ul style="list-style-type: none"> • Make the DVD player's initial settings. • Use a dts-compatible player. • Set to AUTO or dts. 	— — 33
Copying from DVD to VCR is not possible.	<ul style="list-style-type: none"> • Mode video software contains copy prohibit signals. 	<ul style="list-style-type: none"> • Copying is not possible. 	—
No sound is produced from subwoofer.	<ul style="list-style-type: none"> • Subwoofer's power is not on. • Subwoofer's initial setting is set to "NO". • Subwoofer's output is not connected. 	<ul style="list-style-type: none"> • Turn on the power. • Set the setting to "YES". • Connect properly. 	— 19 13
No test tones are produced.	<ul style="list-style-type: none"> • Surround mode is set to a mode other than Dolby Surround. 	<ul style="list-style-type: none"> • Set to Dolby Surround. 	—
No sound is produced from surround speakers.	<ul style="list-style-type: none"> • Surround mode is set to "STEREO". 	<ul style="list-style-type: none"> • Set to a mode other than "STEREO". 	—
Dolby Digital is not possible with LDs.	<ul style="list-style-type: none"> • Not connected to Dolby Digital jacks. 	<ul style="list-style-type: none"> • Connect the LD player's Dolby Digital RF output to the AVR-5800's Dolby Digital RF input jacks. 	7
This unit does not operate properly when remote control unit is used.	<ul style="list-style-type: none"> • Batteries dead. • Remote control unit too far from this unit. • Obstacle between this unit and remote control unit. • Different button is being pressed. • ⊕ and ⊖ ends of battery inserted in reverse. 	<ul style="list-style-type: none"> • Replace with new batteries. • Move closer. • Remove obstacle. • Press the proper button. • Insert batteries properly. 	31 31 31 — 31

16 ADDITIONAL INFORMATION

Optimum surround sound for different sources

There are currently various types of multi-channel signals (signals or formats with more than two channels).

■ Types of multi-channel signals

Dolby Digital (EX), Dolby Pro Logic, DTS (ES), high definition 3-1 signals (Japan MUSE Hi-Vision audio), DVD-Audio, SACD (Super Audio CD), MPEG multi-channel audio, etc.

“Source” here does not refer to the type of signal (format) but the recorded content. Sources can be divided into two major categories.

2 Types of sources

• Movie audio

Signals created to be played in movie theaters. In general sound is recorded to be played in movie theaters equipped with multiple surround speakers, regardless of the format (Dolby Digital, DTS, etc.).

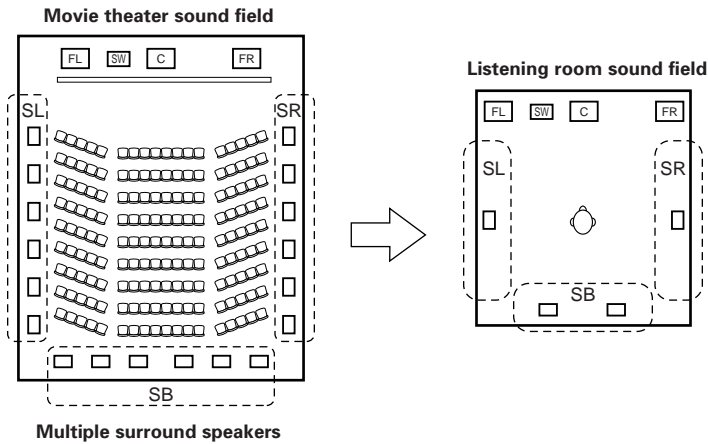

In this case it is important to achieve the same sense of expansion as in a movie theater with the surround channels. To do so, in some cases the number of surround speakers is increased (to four or eight) or speakers with bipolar or dipolar properties are used.

(SL: Surround L channel
SR: Surround R channel
SB: Surround B (back) channel)

- **Other types of audio** These signals are designed to recreate a 360° sound field using three to five speakers.

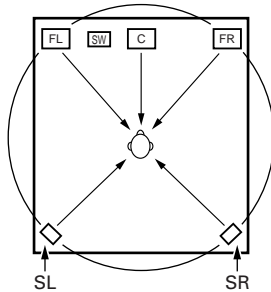

In this case the speakers should surround the listener from all sides to create a uniform sound field from 360°. Ideally the surround speakers should function as “point” sound sources in the same way as the front speakers.

These two types of sources thus have different properties, and different speaker settings, particularly for the surround speakers, are required in order to achieve the ideal sound.

The AVR-5800's surround speaker selection function makes it possible to change the settings according to the combination of surround speakers being used and the surrounding environment in order to achieve the ideal surround sound for all sources. This means that you can connect a pair of bipolar or dipolar surround speakers (mounted on either side of the prime listening position), as well as a separate pair of direct radiating (monopolar) speakers placed at the rear corners of the listening room.

Surround back speakers

The THX Surround EX format adds new "Surround Back" (SB) channels to the conventional 5.1-channel system. This makes it easy to achieve sound positioned directly behind the listener, something that was previously difficult with sources designed for conventional multi surround speakers. In addition, the acoustic image extending between the sides and the rear is narrowed, thus greatly improving the expression of the surround signals for sounds moving from the sides to the back and from the front to the point directly behind the listening position.

Change of positioning and acoustic image with 5.1-channel systems

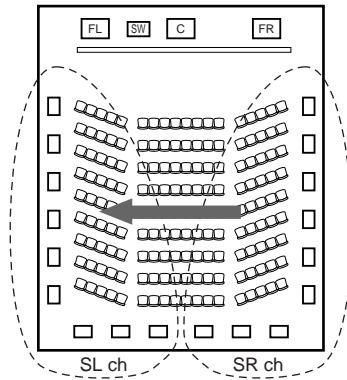

Movement of acoustic image from SR to SL

Change of positioning and acoustic image with THX Surround EX system

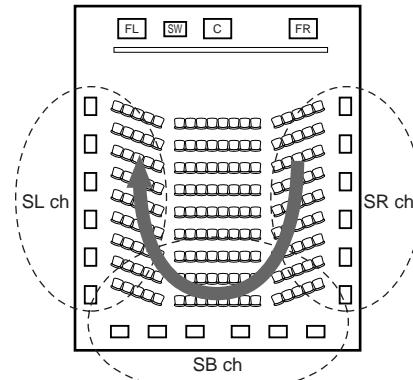

Movement of acoustic image from SR to SB to SL

Speaker(s) for one or two channels are required in order to achieve a THX Surround EX system with the AVR-5800. Adding these, however, allows you to achieve stronger surround effects not only with sources recorded in THX Surround EX, but also with conventional 2- to 5.1-channel sources. The WIDE SCREEN mode is a mode for achieving surround sound with up to 7.1 channels using surround back speakers, for sources recorded in conventional Dolby Surround as well as Dolby Digital 5.1-channel and DTS Surround 5.1-channel sources. Furthermore, all the Denon original surround modes (see page 48) are compatible with 7.1-channel playback, so you can enjoy 7.1-channel sound with any signal source.

■ Number of surround back speakers

With THX Surround EX, the surround back channel consists of one channel of playback signals, but we recommend using two speakers. When using dipolar speakers in particular, it is essential to use two speakers.

Using two speakers results in a smoother blend with the sound of the surround channels and better sound positioning of the surround back channel when listening from a position other than the center.

■ Placement of the surround left and right channels when using surround back speakers

Using surround back speakers greatly improves the positioning of the sound at the rear. Because of this, the surround left and right channels play an important role in achieving a smooth transition of the acoustic image from the front to the back. As shown on the diagram above, in a movie theater the surround signals are also produced from diagonally in front of the listeners, creating an acoustic image as if the sound were floating in space.

To achieve these effects, we recommend placing the speakers for the surround left and right channels slightly more towards the front than with conventional surround systems. Doing so sometimes increases the surround effect when playing conventional 5.1-channel sources in the THX Surround EX mode. Check the surround effects of the various modes before selecting the surround mode.

Speaker setting examples

Here we describe a number of speaker settings for different purposes. Use these examples as guides to set up your system according to the type of speakers used and the main usage purpose.

1. For THX Surround EX systems (using surround back speakers)

(1) Basic setting for primarily watching movies

This is recommended when mainly playing movies and using regular single way or 2-way speakers for the surround speakers.

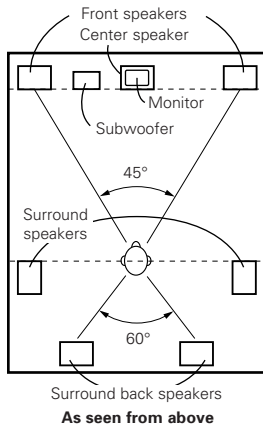

- Set the front speakers with their front surfaces as flush with the TV or monitor screen as possible. Set the center speaker between the front left and right speakers and no further from the listening position than the front speakers.
- Consult the owner's manual for your subwoofer for advice on placing the subwoofer within the listening room.
- If the surround speakers are direct-radiating (monopolar) then place them slightly behind and at an angle to the listening position and parallel to the walls at a position 60 to 90 centimeters (2 to 3 feet) above ear level at the prime listening position.
- When using two surround back speakers, place them at the back facing the front at a narrower distance than the front left and right speakers. When using one surround back speaker, place it at the rear center facing the front at a slightly higher position (0 to 20 cm) than the surround speakers.
- We recommend installing the surround back speaker(s) at a slightly downward facing angle. This effectively prevents the surround back channel signals from reflecting off the monitor or screen at the front center, resulting in interference and making the sense of movement from the front to the back less sharp.
- Connect the surround speakers to the surround speaker A jacks on the AVR-5800 and set all settings on the setup menu to "A". (This is the factory default setting. For details, see page 16.)

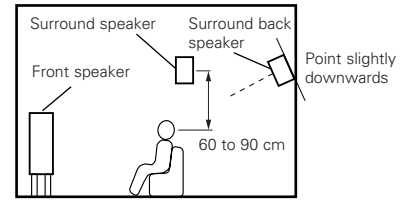

(2) Setting for primarily watching movies using diffusion type speakers for the surround speakers

For the greatest sense of surround sound envelopment, diffuse radiation speakers such as bipolar types, or dipolar (THX) types, provide a wider dispersion than is possible to obtain from a direct radiating speaker (monopolar). Place these speakers at either side of the prime listening position, mounted above ear level.

Path of the surround sound from the speakers to the listening position

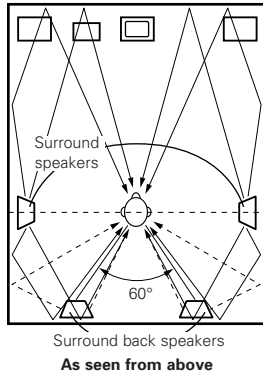

- Set the front speakers, center speaker and subwoofer in the same positions as in example (1).
- It is best to place the surround speakers directly at the side or slightly to the front of the viewing position, and 60 to 90 cm above the ears.
- Same as surround back speaker installation method (1). Using dipolar speakers for the surround back speakers as well is more effective.
- Connect the surround speakers to the surround speaker A jacks on the AVR-5800 and set all settings on the setup menu to "A". (This is the factory default setting. For details, see page 16.)
- The signals from the surround channels reflect off the walls as shown on the diagram at the left, creating an enveloping and realistic surround sound presentation. For multi-channel music sources however, the use of bipolar or dipolar speakers mounted at the sides of the listening position may not be satisfactory in order to create a coherent 360 degree surround sound field. Connect another pair of direct radiating speakers as described in example (3) and place them at the rear corners of the room facing towards the prime listening position.

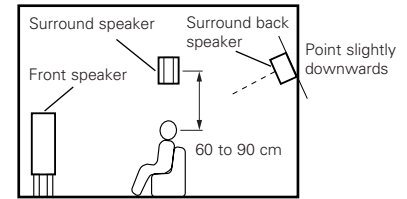

(3) When using different surround speakers for movies and music

To achieve more effective surround sound for both movies and music, use different sets of surround speakers and different surround modes for the two types of sources.

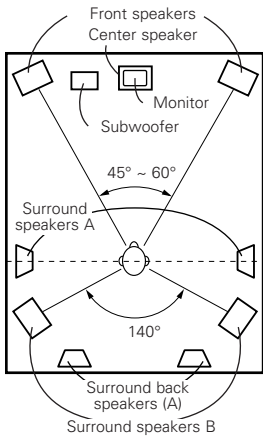

As seen from above

- Set the front speakers slightly wider apart than the setup for watching movies only and point them toward the listening position in order assure clear positioning of the sound.
- Set the center speaker in the same positions as in example (1).
- Set surround speakers A for watching movies in the positions described in example (1) or (2), depending on the types of speakers used.
- Set surround speakers B for playing multi-channel music at the same height as the front speakers and slightly at an angle to the rear of the listening position, and point them toward the listening position.
- Connect the surround speakers for watching movies to the surround speaker A jacks on the AVR-5800, the surround speakers for playing multi-channel music to the surround speaker B jacks. Set the surround speaker selection on the setup menu. (For instructions, see page 19.)
- To activate the appropriate speakers for movies and music, we suggest that during setup, choose Dolby Digital/DTS with THX and Surround Speakers A (the bipolar or dipolar speakers mounted at the sides of the listening position). Choose Dolby Digital/DTS without THX and Surround Speakers B (the direct radiating speakers mounted at the rear corners of the listening room). Then, by simply activating the THX function (used during movie playback, the Surround A speakers are automatically activated. For multi-channel music listening (Dolby Digital or DTS music programs), turn off the THX enhancements by touching the THX button on the remote control, and the Surround B speakers will be automatically activated.

Example: Movie sources (Dolby, DTS surround, etc.)
 "THX" or "THX 5.1" mode: Speakers A
 Music sources (DVD video, DTS CD, etc.)
 "Dolby/DTS surround": Speakers B

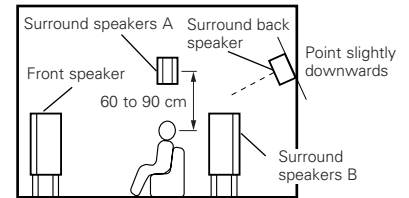

As seen from the side

※ The speakers can be switched at the touch of a button by turning HOME THX CINEMA on when playing movies and off when playing multi-channel music.

2. When not using surround back speakers

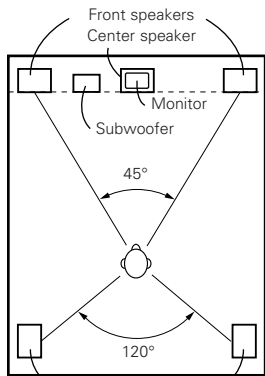

As seen from above

- Set the front speakers with their front surfaces as flush with the TV or monitor screen as possible. Set the center speaker between the front left and right speakers and no further from the listening position than the front speakers.
- Consult the owner's manual for your subwoofer for advice on placing the subwoofer within the listening room.
- If the surround speakers are direct-radiating (monopolar) then place them slightly behind and at an angle to the listening position and parallel to the walls at a position 60 to 90 centimeters (2 to 3 feet) above ear level at the prime listening position.
- Connect the surround speakers to the surround speaker A jacks on the AVR-5800 and set all settings on the setup menu to "A". (This is the factory default setting. For details, see page 16.)

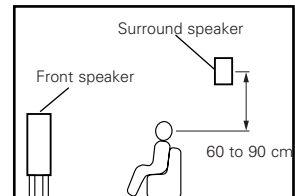

As seen from the side

The surround speakers can be switched freely during playback with the surround parameter adjustment. (For instructions, see page 35.)

Surround

The AVR-5800 is equipped with a digital signal processing circuit that lets you play program sources in the surround mode to achieve the same sense of presence as in a movie theater.

Dolby Surround

(1) Dolby Digital (Dolby Surround AC-3)

Dolby Digital is the multi-channel digital signal format developed by Dolby Laboratories.

Dolby Digital consists of up to "5.1" channels - front left, front right, center, surround left, surround right, and an additional channel exclusively reserved for additional deep bass sound effects (the Low Frequency Effects – LFE – channel, also called the ".1" channel, containing bass frequencies of up to 120 Hz).

Unlike the analog Dolby Pro Logic format, Dolby Digital's main channels can all contain full range sound information, from the lowest bass, up to the highest frequencies – 22 kHz. The signals within each channel are distinct from the others, allowing pinpoint sound imaging, and Dolby Digital offers tremendous dynamic range from the most powerful sound effects to the quietest, softest sounds, free from noise and distortion.

■ Dolby Digital and Dolby Pro Logic

Comparison of home surround systems	Dolby Digital	Dolby Pro Logic
No. recorded channels (elements)	5.1 ch	2 ch
No. playback channels	5.1 ch	4 ch
Playback channels (max.)	L, R, C, SL, SR, SW	L, R, C, S (SW - recommended)
Audio processing	Digital discrete processing Dolby Digital (AC-3) encoding/decoding	Analog matrix processing Dolby Surround
High frequency playback limit of surround channel	20 kHz	7 kHz

■ Dolby Digital compatible media and playback methods

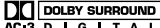
Marks indicating Dolby Digital compatibility:  and .

The following are general examples. Also refer to the player's operating instructions.

Media	Dolby Digital output jacks	Playback method (reference page)
LD (VDP) ※ 1 ※ 2 ※ 3	Coaxial Dolby Digital RF output jack ※ 1 ※ 2 ※ 3	Set the input mode to "AUTO". (Page 33)
DVD ※ 2	Optical or coaxial digital output (same as for PCM) ※ 4	Set the input mode to "AUTO". (Page 33)
Others (satellite broadcasts, CATV, etc.)	Optical or coaxial digital output (same as for PCM)	Set the input mode to "AUTO". (Page 33)

- ※ 1 When playing in Dolby Digital with a Dolby Digital compatible LD player, connect the LD (VDP) player to the VDP function.
- ※ 2 When the LD/DVD compatible player is equipped with Dolby Digital RF outputs, the LD's Dolby Digital output is output from the RF jacks and the DVD's Dolby Digital output is output from the optical or coaxial digital jacks. Select the input mode according to the type of media being played (LD or DVD). You may wish to connect the outboard RF demodulator's digital output to the AVR-5800's VDP input.
- ※ 3 If the player is switched from the pause or search mode to the play mode when playing an LD in the "AUTO" mode (see page 33), analog sound may be output momentarily before the sound switches to Dolby Digital. This is because the Dolby Digital RF signals output from the LD are not output during the pause and search modes, so during this type the input mode is switched according to the "AUTO" mode's signal priority order (see page 33). If this happens, switch to the "RF" (fixed RF input) mode. No analog sound will be output.
- ※ 4 Some DVD digital outputs have the function of switching the Dolby Digital signal output method between "bit stream" and "(convert to) PCM". When playing in Dolby Digital surround on the AVR-5800, switch the DVD player's output mode to "bit stream". In some cases players are equipped with both "bit stream + PCM" and "PCM only" digital outputs. In this case connect the "bit stream + PCM" jacks to the AVR-5800.

(2) Dolby Pro Logic

Dolby Pro Logic is a multi-channel signal playback system developed by Dolby Laboratories which decodes sources recorded in Dolby Surround into four channels: front left, center, front right and surround (the surround channel is monaural, but is played through two surround speakers). Here, "sources recorded in Dolby Surround" are sources on which surround signals (three channels or more) are recorded onto two channels using Dolby Surround encoding technology. Dolby Surround recording is possible for all two-channel signal sources, including soundtracks on DVDs (※), LDs or hi-fi VCRs (for which stereo signal recording is possible), stereo FM, TV and satellite broadcasts, stereo CD, MD and analog cassette tape recordings. Sources recorded in Dolby Surround are compatible with stereo playback, so they can be played in stereo on regular stereo equipment and in surround with Dolby Pro Logic processing. (DTS and Dolby Digital require special decoders to be played.)

With Dolby Pro Logic, the signal levels of the different channels of the source recorded in Dolby Surround are monitored, channels with higher signal levels are emphasized and the level of the other channels is decreased in order to reinforce the directivity and achieve an effective surround sound.

※ DVDs recorded in Dolby Surround include sources recorded in PCM and sources recorded in 2-channel Dolby Digital. For 2-channel Dolby Digital DVD sources, the DVD player's audio mode is 2-channel Dolby Digital, and the AVR-5800's surround mode is Dolby Pro Logic. Use the status button (see page 35) to check whether the Dolby Digital signals are recorded in 2-channel stereo or Dolby Surround.

■ Dolby Pro Logic compatible media and playback methods

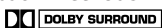
Mark indicating Dolby Pro Logic compatibility: 

When playing in Dolby Pro Logic, select the input signal according to how the player is connected to the AVR-5800, in the same way as selecting the stereo signal. Set the surround mode to "DOLBY SURROUND" to play in Dolby Pro Logic.

Manufactured under license from Dolby Laboratories.
 "Dolby", "Pro Logic" and the double-D symbol are trademarks of Dolby Laboratories.
 Confidential Unpublished Works. ©1992-1997 Dolby Laboratories. All rights reserved.

DTS Digital Surround

DTS Digital Surround (also called simply DTS) is a multi-channel digital signal format developed by Digital Theater Systems.



DTS offers the same "5.1" playback channels as Dolby Digital (front left, front right and center, surround left and surround right) as well as the stereo 2-channel mode. The signals for the different channels are fully independent, eliminating the risk of deterioration of sound quality due to interference between signals, crosstalk, etc.

DTS features a relatively higher bit rate as compared to Dolby Digital (1234 kbps for CDs and LDs, 1536 kbps for DVDs) so it operates with a relatively low compression rate. Because of this the amount of data is great, and when DTS playback is used in movie theaters, a separate CD-ROM synchronized with the film is played.

With LDs and DVDs, there is of course no need for an extra disc; the pictures and sound can be recorded simultaneously on the same disc, so the discs can be handled in the same way as discs with other formats.

There are also music CDs recorded in DTS. These CDs include 5.1-channel surround signals (compared to two channels on current CDs). They do not include picture data, but they offer surround playback on CD players that are equipped with digital outputs (PCM type digital output required). DTS surround track playback offers the same intricate, grand sound as in a movie theater, right in your own listening room.

■ DTS compatible media and playback methods

Marks indicating DTS compatibility:  and .

The following are general examples. Also refer to the player's operating instructions.

Media	Dolby Digital output jacks	Playback method (reference page)
CD	Optical or coaxial digital output (same as for PCM) ※ 2	Set the input mode to "AUTO" or "DTS" (page 33). Never set the mode to "ANALOG" or "PCM". ※ 1
LD (VDP)	Optical or coaxial digital output (same as for PCM) ※ 2	Set the input mode to "AUTO" or "DTS" (page 33). Never set the mode to "ANALOG" or "PCM". ※ 1
DVD	Optical or coaxial digital output (same as for PCM) ※ 3	Set the input mode to "AUTO" or "DTS" (page 33).

※ 1 DTS signals are recorded in the same way on CDs and LDs as PCM signals. Because of this, the un-decoded DTS signals are output as random "hissy" noise from the CD or LD player's analog outputs. If this noise is played with the amplifier set at a very high volume, it may possibly cause damage to the speakers. To avoid this, be sure to switch the input mode to "AUTO" or "DTS" before playing CDs or LDs recorded in DTS. Also, never switch the input mode to "ANALOG" or "PCM" during playback. The same holds true when playing CDs or LDs on a DVD player or LD/DVD compatible player. For DVDs, the DTS signals are recorded in a special way so this problem does not occur.

※ 2 The signals provided at the digital outputs of a CD or LD player may undergo some sort of internal signal processing (output level adjustment, sampling frequency conversion, etc.). In this case the DTS-encoded signals may be processed erroneously, in which case they cannot be decoded by the AVR-5800, or may only produce noise. Before playing DTS signals for the first time, turn down the master volume to a low level, start playing the DTS disc, then check whether the DTS indicator on the AVR-5800 (see page 45) lights before turning up the master volume.

※ 3 A DVD player with DTS-compatible digital output is required to play DTS DVDs. A DTS Digital Output logo is featured on the front panel of compatible DVD players. Recent DENON DVD player models feature DTS-compatible digital output – consult the player's owner's manual for information on configuring the digital output for DTS playback of DTS-encoded DVDs.

Manufactured under license from Digital Theater Systems, Inc. US Pat. No. 5,451,942, 5,956,674, 5,974,380, 5,978,762 and other world-wide patents issued and pending. "DTS", "DTS-ES Extended Surround" and "Neo:6" are trademarks of Digital Theater Systems, Inc. Copyright 1996, 2000 Digital Theater Systems, Inc. All Rights Reserved.

DTS-ES Extended Surround™

DTS-ES Extended Surround is a new multi-channel digital signal format developed by Digital Theater Systems Inc. While offering high compatibility with the conventional DTS Digital Surround format, DTS-ES Extended Surround greatly improves the 360-degree surround impression and space expression thanks to further expanded surround signals. This format has been used professionally in movie theaters since 1999.

In addition to the 5.1 surround channels (FL, FR, C, SL, SR and LFE), DTS-ES Extended Surround also offers the SB (Surround Back, sometimes also referred to as "surround center") channel for surround playback with a total of 6.1 channels. DTS-ES Extended Surround includes two signal formats with different surround signal recording methods, as described below.

■ DTS-ES™ Discrete 6.1

DTS-ES Discrete 6.1 is the newest recording format. With it, all 6.1 channels (including the SB channel) are recorded independently using a digital discrete system. The main feature of this format is that because the SL, SR and SB channels are fully independent, the sound can be designed with total freedom and it is possible to achieve a sense that the acoustic images are moving about freely among the background sounds surrounding the listener from 360 degrees.

Though maximum performance is achieved when sound tracks recorded with this system are played using a DTS-ES decoder, when played with a conventional DTS decoder the SB channel signals are automatically down-mixed to the SL and SR channels, so none of the signal components are lost.

■ DTS-ES™ Matrix 6.1

With this format, the additional SB channel signals undergo matrix encoding and are input to the SL and SR channels beforehand. Upon playback they are decoded to the SL, SR and SB channels. The performance of the encoder used at the time of recording can be fully matched using a high precision digital matrix decoder developed by DTS, thereby achieving surround sound more faithful to the producer's sound design aims than with conventional 5.1- or 6.1-channel systems.

In addition, the bit stream format is 100% compatible with conventional DTS signals, so the effect of the Matrix 6.1 format can be achieved even with 5.1-channel signal sources. Of course it is also possible to play DTS-ES Matrix 6.1 encoded sources with a DTS 5.1-channel decoder.

When DTS-ES Discrete 6.1 or Matrix 6.1 encoded sources are decoded with a DTS-ES decoder, the format is automatically detected upon decoding and the optimum playing mode is selected. However, some Matrix 6.1 sources may be detected as having a 5.1-channel format, so the DTS-ES Matrix 6.1 mode must be set manually to play these sources.

(For instructions on selecting the surround mode, see page 46.)

The DTS-ES decoder includes another function, the DTS Neo:6 surround mode for 6.1-channel playback of digital PCM and analog signal sources.

■ DTS Neo:6™ surround

This mode applies conventional 2-channel signals to the high precision digital matrix decoder used for DTS-ES Matrix 6.1 to achieve 6.1-channel surround playback. High precision input signal detection and matrix processing enable full band reproduction (frequency response of 20 Hz to 20 kHz or greater) for all 6.1 channels, and separation between the different channels is improved to the same level as that of a digital discrete system.

DTS Neo:6 surround includes two modes for selecting the optimum decoding for the signal source.

• DTS Neo:6 Cinema

This mode is optimum for playing movies. Decoding is performed with emphasis on separation performance to achieve the same atmosphere with 2-channel sources as with 6.1-channel sources.

This mode is effective for playing sources recorded in conventional surround formats as well, because the in-phase component is assigned mainly to the center channel (C) and the reversed phase component to the surround (SL, SR and SB channels).

• DTS Neo:6 Music

This mode is suited mainly for playing music. The front channel (FL and FR) signals bypass the decoder and are played directly so there is no loss of sound quality, and the effect of the surround signals output from the center (C) and surround (SL, SR and SB) channels add a natural sense of expansion to the sound field.

Home THX Cinema surround mode

THX is an exclusive set of standards and technologies established by the world-renowned film production company, Lucasfilm Ltd. THX grew from George Lucas' personal desire to make your experience of the film soundtrack, in both movie theaters and in your home theater, as faithful as possible to what the director intended.

Movie soundtracks are mixed in special movie theaters called dubbing stages and are designed to be played back in movie theaters with similar equipment and conditions. The soundtrack created for movie theaters is then transferred directly onto Laserdisc, VHS tape, DVD, etc., and is not changed for playback in a small home theater environment.

THX engineers developed patented technologies to accurately translate the sound from the movie theater environment into the home, correcting the tonal and spatial errors that occur. On the AVR-5800, when the Home THX Cinema mode is on, THX processing is automatically added after the Dolby Pro Logic, Dolby Digital or DTS decoder:

Re-Equalization™

The tonal balance of a film soundtrack will be excessively bright and harsh when played back over audio equipment in the home because film soundtracks are designed to be played back in large movie theaters using very different professional equipment. Re-Equalization restores the correct tonal balance for watching a movie soundtrack in a small home environment.

Timbre Matching™

The human ear changes our perception of a sound depending on the direction from which the sound is coming. In a movie theater, there is an array of surround speakers so that the surround information is all around you. In a home theater, only two speakers located to the side of your head are used. The Timbre Matching feature filters the information going to the surround speakers so that they more closely match the tonal characteristics of the sound coming from the front speakers. This ensures seamless panning between the front and surround speakers.

Adaptive Decorrelation™

In a movie theater, a large number of surround speakers help create an enveloping surround sound experience, while in a home theater there are usually only two speakers. This can make the surround speakers sound like headphones that lack spaciousness and envelopment. The surround sounds will also collapse into the closest speaker as you move away from the middle seating position. Adaptive Decorrelation slightly changes one surround channel's time and phase relationship with respect to the other surround channel. This expands the listening position and creates—with only two speakers—the same spacious surround experience as in a movie theater.

THX Ultra™

Before any home theater component can be THX Ultra certified, it must incorporate all the features above and also pass a rigorous series of quality and performance tests. Only then can a product feature the THX Ultra logo, which is your guarantee that the Home Theater products you purchase will give you superb performance for many years to come. THX Ultra requirements cover every aspect of the product including power amplifier performance, pre-amplifier performance and operation, as well as hundreds of other parameters in both the digital and analog domain.

Lucasfilm, THX, Home THX, Re-Equalization, Timbre Matching, Adaptive Decorrelation and THX Ultra are trademarks of Lucasfilm Ltd.

THX Surround EX

In 1999, a new surround system was launched simultaneously with the release of the movie "Star Wars Episode I". "Dolby Digital Surround EX" is a new movie sound track that greatly enhances the sense of spatial expression and the positioning of the surround channel sound. The result is 360 degrees of movement and moving sound effects that seem to pass right over the listener's head.

This system was developed jointly by Lucasfilm THX and Dolby Laboratories, fusing Lucasfilm's idea of improving spatial expression and achieving a uniform 360 degree sound positioning with Dolby Laboratories' matrix encoding technology. Emphasis was placed on compatibility with the existing system Dolby Digital 5.1-channel, and the new "surround back (SB) channel" was added to achieve improvements over the conventional 5.1-channel system in terms of the positioning of the sound at the rear, the acoustic image of sound moving from the two sides to the back as well as sound moving from the front to the center rear with the multi surround speaker systems used in movie theaters, thereby enabling various types of surround sound.

The surround back channel signal is a matrix-encoded signal inserted into both the Dolby Digital SL (surround left) and SR (surround right) channels. Upon playback, the signals are decoded by a high precision digital matrix decoder within the Dolby Digital decoder into the SL, SR and SB channels and output as 6.1 channels of signals. With the AVR-5800, the signals further undergo Home THX Cinema processing to achieve a THX Surround EX system.

Even without the proper environment for playing the SB channel, Dolby Digital Surround EX signals are 100% compatible with existing 5.1-channel playback systems, so they can be played as such. In this case, the SB channel signal is produced as a monaural signal from both the SL and SR channels, so none of the signal components are missing. The effects specific to THX Surround EX (the sense of spatial expression and the positioning of the sound), however, are the same as with conventional 5.1-channel surround systems.

©Lucasfilm Ltd. & TM. All Rights Reserved. Surround EX is a jointly developed technology of THX and Dolby Laboratories, and is a trademark of Dolby Laboratories. Used under authorization.

System setup items and default values (set upon shipment from the factory)

System setup				Default settings											
1	Speaker Configuration	Input the combination of speakers in your system and their corresponding sizes (SMALL for regular speakers, LARGE for full-size, full-range) to automatically set the composition of the signals output from the speakers and the frequency response.		Front Sp.		Center Sp.		Surround Sp.		Surround Back Sp.		Sub Woofer			
	(Surround Speaker Setting)			Surround mode	DOLBY/DTS SURROUND	THX SURROUND	WIDE SCREEN	5CH/7CH STEREO	DSP SIMULATION	EXT. IN-1	EXT. IN-2	—			
	Subwoofer mode	This selects the subwoofer speaker for playing deep bass signals.		LFE —THX—											
2	SB CH Auto Flag Detect	Set the method of playing the surround back channel for digital signals.		Auto Flag Detect Mode = OFF											
3	Delay Time	This parameter is for optimizing the timing with which the audio signals are produced from the speakers and subwoofer according to the listening position.		Front L & R		Center		Surround L & R		SBL & SBR		Sub Woofer			
				12 ft (3.6 m)		12 ft (3.6 m)		10 ft (3.0 m)		10 ft (3.0 m)		12 ft (3.6 m)			
4	Multi Zone Control	Multi Zone-1 vol. Level	This sets the output level for the multi-zone 1 output jacks.		Variable										
		Power AMP Assignment	Set this to switch the surround back channel's power amplifier for use for multi-zone 2.		Surround Back										
5	Channel Level	This adjusts the volume of the signals output from the speakers and subwoofer for the different channels in order to obtain optimum effects.		Front L	Front R	Center	Surround L	Surround R	Surround Back L	Surround Back R	Subwoofer				
				0 dB	0 dB	0 dB	0 dB	0 dB	0 dB	0 dB	0 dB				
6	Subwoofer Peak Limit Lev	This parameter is for detecting the maximum level of the low bass signals output from the subwoofer channel in order to protect the subwoofer from damage and prevent unpleasant distorted sounds from being produced.		Peak Limiter = OFF											
7	Digital In Assignment	This assigns the digital input jacks for the different input sources.		Input source	CD	DVD	VDP	TV	DBS/SAT	VCR-1	VCR-2	VCR-3	TAPE-1	TAPE-2	V. AUX
				Digital Inputs	COAXIAL 1	COAXIAL 2	COAXIAL 3	OPTICAL 1	OPTICAL 2	OPTICAL 3	OPTICAL 4	OFF	OPTICAL 5	OPTICAL 6	OFF
8	On Screen Display	This sets whether or not to display the on-screen display that appears on the monitor screen when the controls on the remote control unit or main unit are operated (from MONITOR 1 outputs only).		On Screen Display = ON											
9	Auto Tuner Presets	FM stations are received automatically and stored in the memory.		A1 ~ A8	87.5/89.1/98.1/107.9/90.1/90.1/90.1/90.1 MHz										
				B1 ~ B8	520/600/1000/1400/1500/1710 kHz/90.1/90.1 MHz										
				C1 ~ C8	90.1 MHz										
				D1 ~ D8	90.1 MHz										
				E1 ~ E8	90.1 MHz										

Surround modes and parameters

Mode	Signals and adjustability in the different modes														
	Channel output					Parameter (default values are shown in parentheses)								When playing Dolby Digital and DTS signals	
	FRONT L/R	CENTER	SURROUND L/R	SURROUND BACK /EFFECT L/R	SUB-WOOFER	TONE CONTROL	CINEMA EQ.	EFFECT	LEVEL	ROOM SIZE	EFFECT LEVEL	DELAY TIME	D.COMP.	AFDM	SB CH OUT
PURE DIRECT, DIRECT	○	×	×	×	⊙	×	×	×	×	×	×	×	○ (OFF)	×	×
STEREO	○	×	×	×	⊙	○ (0dB)	×	×	×	×	×	×	○ (OFF)	×	×
EXTERNAL INPUT	○	⊙	⊙	⊙	⊙	○ (0dB)	×	×	×	×	×	×	×	×	×
WIDE SCREEN	○	⊙	⊙	⊙	⊙	○ (0dB)	○ (OFF)	○ (ON)	○ (10)	×	×	×	○ (OFF)	×	○
HOME THX CINEMA	○	⊙	⊙	⊙	⊙	×	×	×	×	×	×	×	○ (OFF)	○	○
DOLBY PRO LOGIC	○	⊙	⊙	⊙	⊙	○ (0dB)	○ (OFF)	×	×	×	×	×	○ (OFF)	○	○
DOLBY DIGITAL	○	⊙	⊙	⊙	⊙	○ (0dB)	○ (OFF)	×	×	×	×	×	○ (OFF)	○	○
DTS SURROUND	○	⊙	⊙	⊙	⊙	○ (0dB)	○ (OFF)	×	×	×	×	×	○ (OFF)	○	○
DTS STEREO SURROUND	○	⊙	⊙	⊙	⊙	○ (0dB)	×	×	×	×	×	×	×	○	○
5CH/7CH STEREO	○	⊙	⊙	⊙	⊙	○ (0dB)	×	×	×	×	×	×	○ (OFF)	×	○
SUPER STADIUM	○	⊙	⊙	⊙	⊙	○ (note 1)	×	×	×	○ (Medium)	○ (10)	×	○ (OFF)	×	○
ROCK ARENA	○	⊙	⊙	⊙	⊙	○ (note 2)	×	×	×	○ (Medium)	○ (10)	×	○ (OFF)	×	○
JAZZ CLUB	○	⊙	⊙	⊙	⊙	○ (0dB)	×	×	×	○ (Medium)	○ (10)	×	○ (OFF)	×	○
CLASSIC CONCERT	○	⊙	⊙	⊙	⊙	○ (0dB)	×	×	×	○ (Medium)	○ (10)	×	○ (OFF)	×	○
MONO MOVIE	○	⊙	⊙	⊙	⊙	○ (0dB)	×	×	×	○ (Medium)	○ (10)	×	○ (OFF)	×	○
MATRIX	○	⊙	⊙	⊙	⊙	○ (0dB)	×	×	×	×	×	○ (30msec)	○ (OFF)	×	○

○ : Signal/adjustable

(Note 1) BASS: +6dB, TREBLE: 0dB

(Note 2) BASS: +8dB, TREBLE: +4dB

⊙ : Turned on or off by speaker configuration setting

× : No signal/not adjustable

17 SPECIFICATIONS

■ Audio section

• Power amplifier

Rated output:

(All properties shown are only for the power amplifier stage.)

Dynamic power:

Output terminals:

Stereo (2ch driven)

170 W + 170 W (8 Ω /ohms, 20 Hz ~ 20 kHz with 0.05% T.H.D.)

200 W + 200 W (6 Ω /ohms, 20 Hz ~ 20 kHz with 0.05% T.H.D.)

190 W x 2 ch (8 Ω /ohms)

310 W x 2 ch (4 Ω /ohms)

390 W x 2 ch (2 Ω /ohms)

Front/Center: 6 ~ 16 Ω /ohms

Surround: A or B 6 ~ 16 Ω /ohms

A + B 8 ~ 16 Ω /ohms

• Analog

Input sensitivity / input impedance:

200 mV / 47 k Ω /kohms

Frequency response:

10 Hz ~ 100 kHz: +0, -3 dB (DIRECT mode)

S/N:

105 dB (DIRECT mode)

Distortion:

0.005% (20 Hz ~ 20 kHz) (DIRECT mode)

Rated output/maximum output:

1.2 V / 8 V

• Digital

D/A output:

Rated output — 2 V (at 0 dB playback)

Total harmonic distortion — 0.003% (1 kHz, at 0 dB)

S/N ratio — 115 dB

Dynamic range — 112 dB

Format — Digital audio interface

Digital input:

• Phono equalizer (PHONO input — REC OUT)

Input sensitivity:

2.5 mV

RIAA deviation:

± 1 dB (20 Hz to 20 kHz)

Signal-to-noise ratio:

74 dB (A weighting, with 5 mV input)

Rated output / Maximum output:

150 mV / 8 V

Distortion factor:

0.03% (1 kHz, 3 V)

■ Video section

• Standard video jacks

Input / output level and impedance:

1 Vp-p, 75 Ω /ohms

Frequency response:

5 Hz ~ 10 MHz — +0, -3 dB

• S-video jacks

Input / output level and impedance:

Y (brightness) signal — 1 Vp-p, 75 Ω /ohms

C (color) signal — 0.286 Vp-p, 75 Ω /ohms

5 Hz ~ 10 MHz — +0, -3 dB

Frequency response:

• Color component video terminal

Input / output level and impedance:

Y (brightness) signal — 1 Vp-p, 75 Ω /ohms

Cb (blue) signal — 0.7 Vp-p, 75 Ω /ohms

Cr (red) signal — 0.7Vp-p, 75 Ω /ohms

DC ~ 50 MHz — +0, -3 dB

Frequency response:

■ Tuner section

Receiving Range:

[FM] (note: μ V at 75 Ω /ohms, 0 dBf = 1×10^{-15} W)

87.5 MHz ~ 107.9 MHz

[AM]

520 kHz ~ 1710 kHz

Usable Sensitivity:

1.0 μ V (11.2 dBf)

18 μ V

50 dB Quieting Sensitivity:

MONO 1.6 μ V (15.3 dBf)

STEREO 23 μ V (38.5 dBf)

Signal to Noise Ratio (IHF-A):

MONO 80 dB

50 dB

STEREO 75 dB

Total Harmonic Distortion (at 1 kHz):

MONO 0.15%

STEREO 0.3%

■ General

Power supply:

AC 120 V, 60 Hz

Power consumption:

12 A

Maximum external dimensions:

434 (W) x 216 (H) x 486 (D) mm (17-3/32" x 8-1/2" x 19-9/64")

Mass:

28.0 kg (61 lbs 11.7 oz)

■ Remote control unit (RC-8000)

Batteries:

LR6/AA Type (four batteries)

External dimensions:

96 (W) x 38 (H) x 168.5 (D) mm (3-25/32" x 1-1/2" x 6-41/64")

Mass:

242 g (Approx. 8.5 oz) (not including batteries)

* For purposes of improvement, specifications and design are subject to change without notice.

NIPPON COLUMBIA CO., LTD.

14-14, AKASAKA 4-CHOME, MINATO-KU, TOKYO 107-8011, JAPAN
Telephone: (03) 3584-8111

Printed in Japan 511 3624 006

Free Manuals Download Website

<http://myh66.com>

<http://usermanuals.us>

<http://www.somanuals.com>

<http://www.4manuals.cc>

<http://www.manual-lib.com>

<http://www.404manual.com>

<http://www.luxmanual.com>

<http://aubethermostatmanual.com>

Golf course search by state

<http://golfingnear.com>

Email search by domain

<http://emailbydomain.com>

Auto manuals search

<http://auto.somanuals.com>

TV manuals search

<http://tv.somanuals.com>