

D0801.201

D1422.01

D0801.01

D341.FS

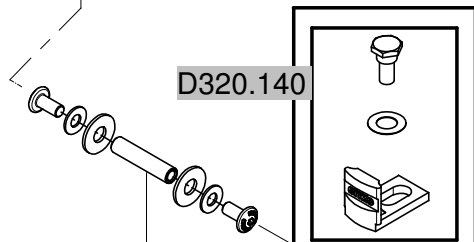
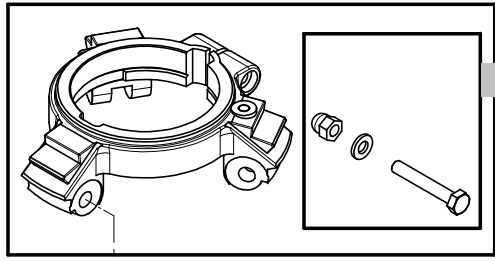

D320.140

A

D09508.32

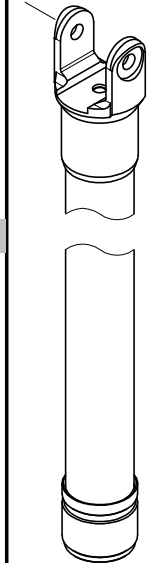
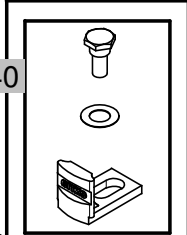

D0401.32

D0402.32

D0301.28

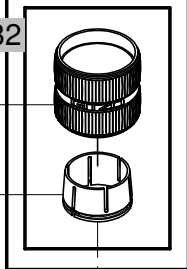

D340.52

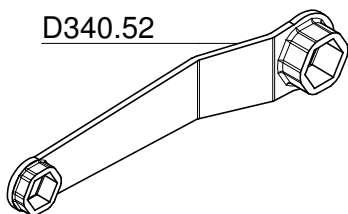

C

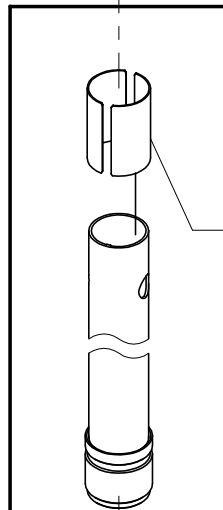

D0201.28
(2 pcs)

D09507.28

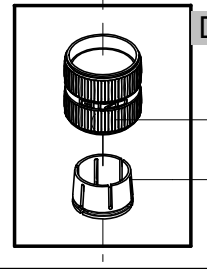

D0401.28

D0402.28

D0301.24

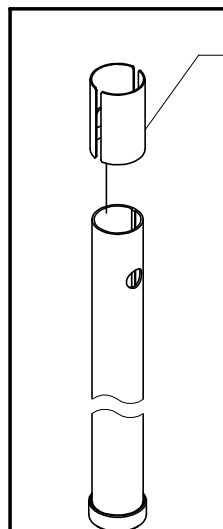

D0201.24
(2 pcs)

D09514.24

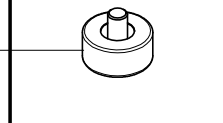

D06.13
quantity 2

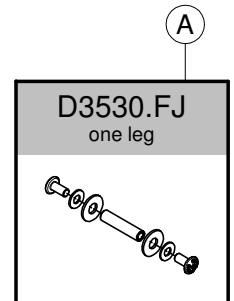
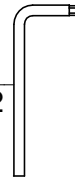

D3530.FJ
one leg

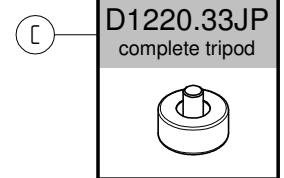

D1220.33JP
complete tripod

GT3530LSV

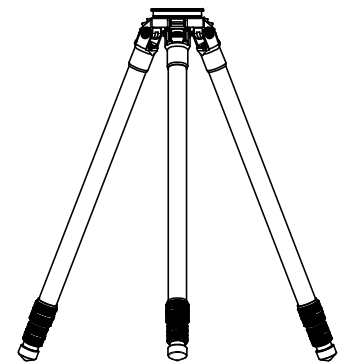

For serial numbers from G0109835

Free Manuals Download Website

<http://myh66.com>

<http://usermanuals.us>

<http://www.somanuals.com>

<http://www.4manuals.cc>

<http://www.manual-lib.com>

<http://www.404manual.com>

<http://www.luxmanual.com>

<http://aubethermostatmanual.com>

Golf course search by state

<http://golfingnear.com>

Email search by domain

<http://emailbydomain.com>

Auto manuals search

<http://auto.somanuals.com>

TV manuals search

<http://tv.somanuals.com>