

D0701.08
D3.6586 [5 pcs]

D4040.37

D3.2760

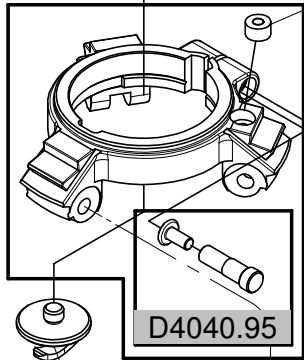

D0801.01

D4040.95

D4040.77

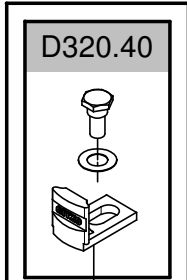

D320.40

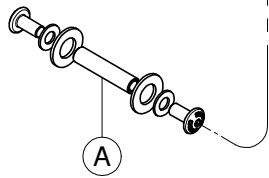

A

D09504.33

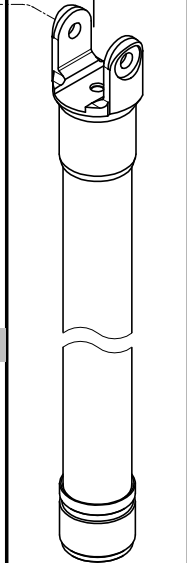

D09506.28

D0401.32

D0402.32

D0301.28

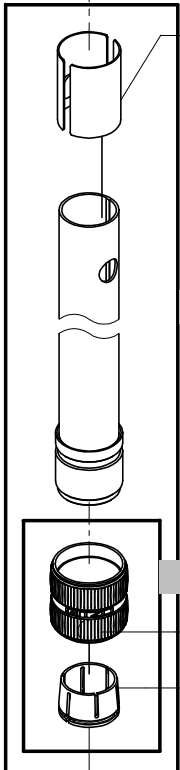
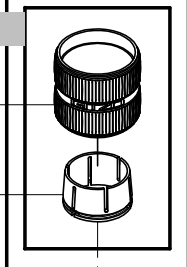

D0201.28
(2 pcs)

D002.20

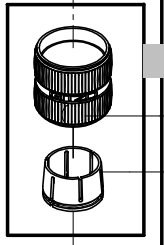

D0401.28

D0402.28

D0301.24

B

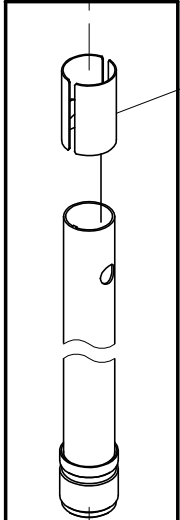

D0201.24
(2 pcs)

D09506.24

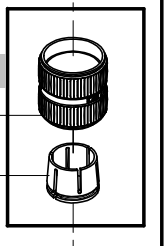

D0401.24

D0402.24

D0301.20

D06.13
quantity 2

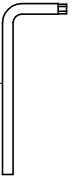

D09507.20

D3.2360



A

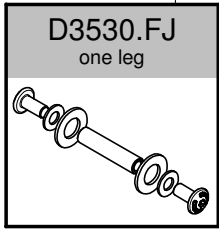

D3530.FJ
one leg

B

D0609.01
3 pcs

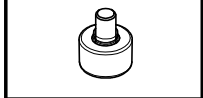

GT3541LS

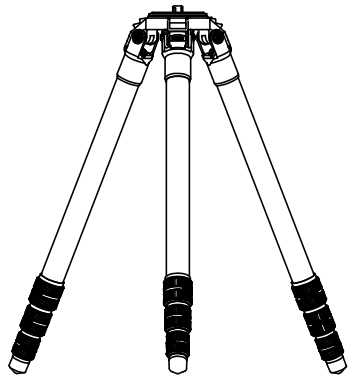

For serial numbers from G0189201

Free Manuals Download Website

<http://myh66.com>

<http://usermanuals.us>

<http://www.somanuals.com>

<http://www.4manuals.cc>

<http://www.manual-lib.com>

<http://www.404manual.com>

<http://www.luxmanual.com>

<http://aubethermostatmanual.com>

Golf course search by state

<http://golfingnear.com>

Email search by domain

<http://emailbydomain.com>

Auto manuals search

<http://auto.somanuals.com>

TV manuals search

<http://tv.somanuals.com>