

FRIGIDAIRE

All about the

Use & Care

of your Microwave Oven

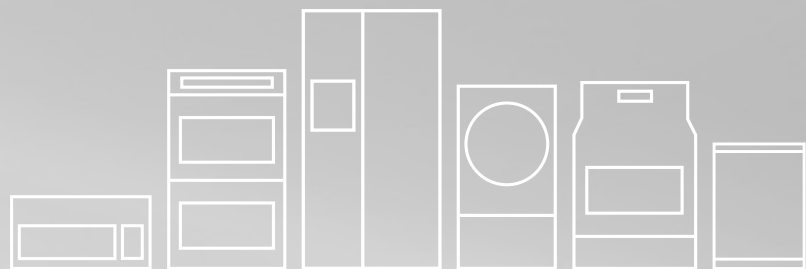

TABLE OF CONTENTS

WELCOME & CONGRATULATIONS	2	AUTO COOKING.....	12
IMPORTANT SAFETY INSTRUCTIONS.....	2	CONVENIENT FEATURES.....	17
PART NAMES & CONTROL PANEL	8	CLEANING AND CARE.....	19
BEFORE OPERATING	9	SERVICE CALL CHECK	20
MANUAL OPERATION	9	SPECIFICATIONS.....	20
SENSOR COOKING	10	MAJOR APPLIANCE WARRANTY INFORMATION	21

WELCOME & CONGRATULATIONS

Questions?

1-800-944-9044

(United States)

1-800-265-8352

(Canada)

Please attach sales receipt here for future reference.

Congratulations on your purchase of a new microwave oven! At **Electrolux Home Products**, we are very proud of our product and are completely committed to providing you with the best service possible. Your satisfaction is our number one priority.

We know you'll enjoy your new microwave oven and **Thank You** for choosing our product. We hope you consider us for future purchases.

PLEASE CAREFULLY READ AND SAVE THESE INSTRUCTIONS

This Use & Care Manual provides specific operating instructions for your model. Use your microwave oven only as instructed in this manual. These instructions are not meant to cover every possible condition and situation that may occur. Common sense and caution must be practiced when installing, operating and maintaining any appliance.

Please record your model and serial numbers below for future reference.

Model Number: _____

Serial Number: _____

Purchase Date: _____

NEED HELP?

Visit the Frigidaire Web Site at: <http://www.frigidaire.com>

Before you call for service, there are a few things you can do to help us serve you better.

Read this manual.

It contains instructions to help you use and maintain your microwave oven properly.

If you received a damaged Microwave Oven... immediately contact the dealer (or builder) that sold you the Microwave Oven.

Save time and money.

Check the section titled "Service Call Check". This section helps you solve common problems that might occur. If you do need service, you can relax knowing help is only a phone call away. A list of toll-free customer service numbers is included in the back of this manual. Or call Electrolux Customer Services at 1-800-944-9044, 24 hours a day, 7 days a week.

IMPORTANT SAFETY INSTRUCTIONS

For your safety the information in this manual must be followed to minimize the risk of fire or explosion or to prevent property damage, personal injury or loss of life.



PRECAUTIONS TO AVOID POSSIBLE EXPOSURE TO EXCESSIVE MICROWAVE ENERGY

- (A) **Do Not Attempt** to operate this microwave oven with the door open since open-door operation can result in harmful exposure to microwave energy. It is important not to defeat or tamper with the safety interlocks.
- (B) **Do Not Place** any object between the microwave oven front face and the door or allow soil or cleaner residue to accumulate on sealing surfaces.
- (C) **Do Not Operate** the microwave oven if it is damaged. It is particularly important that the microwave oven door close properly and that there is no damage to the: (1) door (bent), (2) hinges and latches (broken or loosened), (3) door seals and sealing surfaces.
- (D) **The Microwave Oven Should Not** be adjusted or repaired by anyone except properly qualified service personnel.

IMPORTANT SAFETY INSTRUCTIONS

Definitions

 This is the safety alert symbol. It is used to alert you to potential personal injury hazards. Obey all safety messages that follow this symbol to avoid possible injury or death.

WARNING

This symbol will help alert you to situations that may cause serious bodily harm, death or property damage.

CAUTION

This symbol will help alert you to situations that may cause bodily injury or property damage.

READ ALL INFORMATION BEFORE USING

When using electrical appliances basic safety precautions should be followed, including the following:

WARNING

To reduce the risk of fire, burns, electric shock, injury to persons, or exposure to excessive microwave energy when using your appliance, follow basic **precautions, including the following sections.**

- Read all instructions before using the appliance.
 - Read and follow the specific **"PRECAUTIONS TO AVOID POSSIBLE EXPOSURE TO EXCESSIVE MICROWAVE ENERGY"** on page 2.
 - This appliance must be grounded. Connect only to properly grounded outlet. See **"ELECTRICAL GROUNDING INSTRUCTIONS"** on page 4.
 - Install or locate this appliance only in accordance with the provided installation instructions.
 - Some products such as whole eggs and sealed containers—for example, closed glass jars—are able to explode and should not be heated in this microwave oven.
 - Use this appliance only for its intended use as described in this manual. Do not use corrosive chemicals or vapors in this appliance. This type of microwave oven is specifically designed to heat, cook or dry food. It is not designed for industrial or laboratory use.
 - As with any appliance, close supervision is necessary when used by children.
 - Do not operate this appliance if it has a damaged cord or plug, if it is not working properly or if it has been damaged or dropped.
 - This appliance should be serviced only by qualified service personnel. Contact nearest Electrolux Authorized Servicer for examination, repair or adjustment.
 - Do not cover or block any openings on the appliance.
 - Do not store or use this appliance outdoors. Do not use this product near water—for example, near a kitchen sink, in a wet basement or near a swimming pool, or similar locations.
 - Do not immerse cord or plug in water.
 - Keep cord away from heated surfaces.
 - Do not let cord hang over edge of table or counter.
- See door surface cleaning instructions on page 18.
 - To reduce the risk of fire in the microwave oven cavity:
 - Do not overcook food. Carefully attend appliance when paper, plastic or other combustible materials are placed inside the microwave oven to facilitate cooking.
 - Remove wire twist-ties from paper or plastic bags before placing bag in microwave oven.
 - **If materials inside the microwave oven should ignite, keep microwave oven door closed, turn microwave oven off and disconnect the power cord or shut off power at the fuse or circuit breaker panel.**
 - Do not use the cavity for storage purposes. Do not leave paper products, cooking utensils or food in the cavity when not in use.
 - Liquids, such as water, coffee or tea are able to be overheated beyond the boiling point without appearing to be boiling. Visible bubbling or boiling when the container is removed from the microwave oven is not always present. **THIS COULD RESULT IN VERY HOT LIQUIDS SUDDENLY BOILING OVER WHEN A SPOON OR OTHER UTENSIL IS INSERTED INTO THE LIQUID.**
 - To reduce the risk of injury to persons:
 - Do not overheat the liquid.
 - Stir the liquid both before and halfway through heating it.
 - Do not use straight-sided containers with narrow necks. Use a wide-mouthed container.
 - After heating, allow the container to stand in the microwave oven at least for 20 seconds before removing the container.
 - Use extreme care when inserting a spoon or other utensil into the container.
 - If the microwave oven is installed as a built-in, observe the following instructions:
 - Do not mount over a sink.
 - Do not store anything directly on top of the appliance surface when the appliance is in operation.
 - If the microwave oven light fails, consult a Electrolux AUTHORIZED SERVICER.

SAVE THESE INSTRUCTIONS

IMPORTANT SAFETY INSTRUCTIONS

UNPACKING AND EXAMINING YOUR MICROWAVE OVEN

Remove:

- All packing materials from inside the microwave oven cavity; however, **DO NOT REMOVE THE WAVEGUIDE COVER**, which is located on the right cavity wall. Read enclosures and **SAVE** the Use and Care Manual.
- The feature sticker, if there is one, from the outside of the door.

Check the microwave oven for any damage, such as misaligned or bent door, damaged door seals and sealing surfaces, broken or loose door hinges and latches and dents inside the cavity or on the door. If there is any damage, do not operate the microwave oven and contact your dealer or Electrolux **AUTHORIZED SERVICER**.

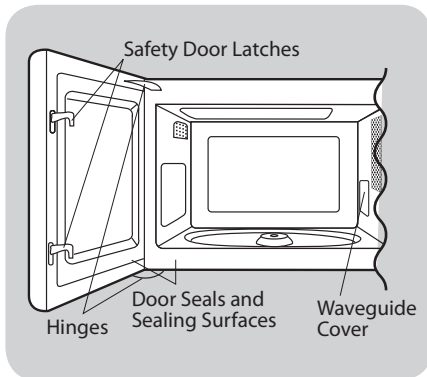

CHOOSING A LOCATION FOR YOUR MICROWAVE OVEN ON THE COUNTER

You will use the microwave oven frequently so plan its location for ease of use. It's wise, if possible, to have counter space on at least one side of the microwave oven. Allow at least 2 inches on the sides, top and at the rear of the microwave oven for air circulation.

For installation over a wall oven, please refer to your installation instructions.

ELECTRICAL GROUNDING INSTRUCTIONS

This appliance must be grounded. This microwave oven is equipped with a cord having a grounding wire with a grounding plug. It must be plugged into a wall receptacle that is properly installed and grounded in accordance with the National Electrical Code and local codes and ordinances. In the event of an electrical short circuit, grounding reduces risk of electric shock by providing an escape wire for the electric current.

WARNING

Improper use of the grounding plug can result in a risk of electric shock.

Electrical Requirements

Check Installation Instructions for proper location for the power supply.

The electrical requirements are a 120 volt 60 Hz, AC only, 15 amp. or more protected electrical supply. It is recommended that a separate circuit serving only the microwave oven be provided.

The microwave oven is equipped with a 3-prong grounding plug. It must be plugged into a wall receptacle that is properly installed and grounded. **DO NOT UNDER ANY CIRCUMSTANCES CUT OR REMOVE THE GROUNDING PIN FROM THE PLUG.**

Permanent and Correct Installation

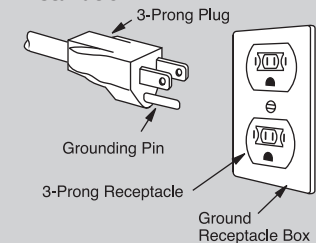

Extension Cord

If it is necessary to use an extension cord, use only a 3-wire extension cord that has a 3-blade grounding plug and a 3-slot receptacle that will accept the plug on the microwave oven. The marked rating of the extension cord should be AC 115-120 volt, 15 amp. or more.

Be careful not to drape the cord over the countertop or table where it can be pulled on by children or tripped over accidentally.

NOTES

1. If you have any questions about the grounding or electrical instructions, consult a qualified electrician or service person.
2. Neither Electrolux nor the dealer can accept any liability for damage to the microwave oven or personal injury resulting from failure to observe the correct electrical connection procedures.

IMPORTANT SAFETY INSTRUCTIONS

Federal Communications Commission Radio Frequency Interference Statement (U.S.A. Only)

This equipment generates and uses ISM frequency energy and if not installed and used properly, that is in strict accordance with the manufacturer's instructions, may cause interference to radio and television reception. It has been type tested and found to comply with limits for ISM Equipment pursuant to part 18 of FCC Rules, which are designed to provide reasonable protection against such interference in a residential installation.

However, there is no guarantee that interference will not occur in a particular installation. If this equipment does cause interference to radio or television reception, which can be determined by turning the equipment off and on, the user is encouraged to try to correct the interference by one or more of the following:

- Reorient the receiving antenna of the radio or television.
- Relocate the microwave oven with respect to the receiver.
- Move the microwave oven away from the receiver.
- Plug the microwave oven into a different outlet so that the microwave oven and the receiver are on different branch circuits.

The manufacturer is not responsible for any radio or television interference caused by unauthorized modification to this microwave oven. It is the responsibility of the user to correct such interference.

ABOUT YOUR MICROWAVE OVEN

This Use and Care Manual is valuable: read it carefully and always save it for reference.

A good microwave cookbook is a valuable asset. Check it for microwave cooking principles, techniques, hints and recipes.

NEVER use the microwave oven without the turntable and support nor turn the turntable over so that a large dish could be placed in the microwave oven. The turntable will turn both clockwise and counterclockwise.

ALWAYS have food in the microwave oven when it is on to absorb the microwave energy.

When using the microwave oven at power levels below 100%, you may hear the magnetron cycling on and off. It is normal for the exterior of the microwave oven to be warm to the touch when cooking or reheating.

Condensation is a normal part of microwave cooking. Room humidity and the moisture in food will influence the amount of moisture that condenses in the microwave oven. Generally, covered foods will not cause as much condensation as uncovered ones. Ventilation openings must not be blocked.

The microwave oven is for food preparation only. It should not be used to dry clothes or newspapers.

All microwave ovens are rated by using the IEC Test Procedure as 1200 watts, except for CPM0209 and CGMO205 which are 1100 watts. In using recipes or package directions, check food a minute or two before the minimum time and add time accordingly.

ABOUT MICROWAVE COOKING

- Arrange food carefully. Place thickest areas towards outside of dish.
- Watch cooking time. Cook for the shortest amount of time indicated and add more as needed. Food severely overcooked can smoke or ignite.
- Cover foods while cooking. Check recipe or cookbook for suggestions: paper towels, wax paper, microwave plastic wrap or a lid. Covers prevent spattering and help foods to cook evenly.
- Shield with small flat pieces of aluminum foil any thin areas of meat or poultry to prevent overcooking before dense, thick areas are cooked thoroughly.
- Stir foods from outside to center of dish once or twice during cooking, if possible.
- Turn foods over once during microwaving to speed cooking of such foods as chicken and hamburgers. Large items like roasts must be turned over at least once.
- Rearrange foods such as meatballs halfway through cooking both from top to bottom and from the center of the dish to the outside.
- Add standing time. Remove food from microwave oven and stir, if possible. Cover for standing time which allows the food to finish cooking without overcooking.
- Check for doneness. Look for signs indicating that cooking temperatures have been reached.
- **Doneness signs include:**
 - Food steams throughout, not just at edge.
 - Center bottom of dish is very hot to the touch.
 - Poultry thigh joints move easily.
 - Meat and poultry show no pinkness.
 - Fish is opaque and flakes easily with a fork.

IMPORTANT SAFETY INSTRUCTIONS

ABOUT FOOD

FOOD	DO	DON'T
Eggs, sausages, nuts, seeds, fruits & vegetables	<ul style="list-style-type: none">• Puncture egg yolks before cooking to prevent "explosion".• Pierce skins of potatoes, apples, squash, hot dogs and sausages so that steam escapes.	<ul style="list-style-type: none">• Cook eggs in shells.• Reheat whole eggs.• Dry nuts or seeds in shells.
Popcorn	<ul style="list-style-type: none">• Use specially bagged popcorn for microwave cooking.• Listen while popping corn for the popping to slow to 1 or 2 seconds or use special popcorn pad.	<ul style="list-style-type: none">• Pop popcorn in regular brown bags or glass bowls.• Exceed maximum time on popcorn package.
Baby food	<ul style="list-style-type: none">• Transfer baby food to small dish and heat carefully, stirring often. Check temperature before serving.• Put nipples on bottles after heating and shake thoroughly. "Wrist" test before feeding.	<ul style="list-style-type: none">• Heat disposable bottles.• Heat bottles with nipples on.• Heat baby food in original jars.
General	<ul style="list-style-type: none">• Cut baked goods with filling after heating to release steam and avoid burns.• Stir liquids briskly before and after heating to avoid "eruption".• Use deep bowl, when cooking liquids or cereals, to prevent boilovers.	<ul style="list-style-type: none">• Heat or cook in closed glass jars or air tight containers.• Can in the microwave as harmful bacteria may not be destroyed.• Deep fat fry.• Dry wood, gourds, herbs or wet papers.

ABOUT UTENSILS AND COVERINGS

It is not necessary to buy all new cookware. Many pieces already in your kitchen can be used successfully in your new microwave oven. Make sure the utensil does not touch the interior walls during cooking.

Use these utensils for safe microwave cooking and reheating:

- Glass ceramic (Pyroceram®), such as Corningware®.
- Heat-resistant glass (Pyrex®)
- Microwave-safe plastics
- Paper plates
- Microwave-safe pottery, stoneware and porcelain
- Browning dish (Do not exceed recommended preheating time. Follow manufacturer's directions.)

These items can be used for short time reheating of foods that have little fat or sugar in them:

- wood, straw, wicker

DO NOT USE

- Metal pans and bakeware
- Dishes with metallic trim
- Non-heat-resistant glass

- Non-microwave-safe plastics (margarine tubs)
- Recycled paper products
- Brown paper bags
- Food storage bags
- Metal twist-ties

Should you wish to check if a dish is safe for microwaving, place the empty dish in the microwave oven and microwave on HIGH for 30 seconds. A dish which becomes very hot should not be used.

The following coverings are ideal:

- Paper towels are good for covering foods for reheating and absorbing fat while cooking bacon.
- Wax paper can be used for cooking and reheating.
- Plastic wrap that is specially marked for microwave use can be used for cooking and reheating. DO NOT allow plastic wrap to touch food. Vent so steam can escape.
- Lids that are microwave-safe are a good choice because heat is kept near the food to hasten cooking.
- Oven cooking bags are good for large meats or foods that need tenderizing. DO NOT use metal twist ties. Remember to slit bag so steam can escape.

IMPORTANT SAFETY INSTRUCTIONS

How to use aluminum foil in your microwave oven:

- Small flat pieces of aluminum foil placed smoothly on the food can be used to shield areas that are either defrosting or cooking too quickly.
- Foil should not come closer than one inch to any surface of the microwave oven.

Should you have questions about utensils or coverings, check a good microwave cookbook or follow recipe suggestions.

ACCESSORIES There are many microwave accessories available for purchase. Evaluate carefully before you purchase so that they meet your needs. A microwave-safe thermometer will assist you in determining correct doneness and assure you that foods have been cooked to safe temperatures. Electrolux is not responsible for any damage to the microwave oven when accessories are used.

ABOUT CHILDREN AND THE MICROWAVE

Children below the age of 7 should use the microwave oven with a supervising person very near to them. Between the ages of 7 and 12, the supervising person should be in the same room.

At no time should anyone be allowed to lean or swing on the microwave oven door.

Children should be taught all safety precautions: use potholders, remove coverings carefully, pay special attention to packages that crisp food because they may be extra hot.

Don't assume that because a child has mastered one cooking skill he/she can cook everything.

Children need to learn that the microwave oven is not a toy. See page 17 for CHILD LOCK feature.

ABOUT SAFETY

- Check foods to see that they are cooked to the United States Department of Agriculture's recommended temperatures.

TEMP	FOOD
145°F (63°C)	Fish
160°F (71°C)	Pork, ground beef/veal/lamb, egg dishes
165°F (74°C)	For leftover, ready-to-reheat refrigerated, and deli and carry-out "fresh" food. Whole, pieces and ground turkey/chicken/duck.
170°F (77°C)	White meat of poultry.
175°F (79°C)	Dark meat of poultry.

NOTE

Do not cook whole, stuffed poultry. Cook stuffing separately to 165°F.

To test for doneness, insert a meat thermometer in a thick or dense area away from fat or bone. NEVER leave the thermometer in the food during cooking, unless it is approved for microwave oven use.

- ALWAYS use potholders to prevent burns when handling utensils that are in contact with hot food. Enough heat from the food can transfer through utensils to cause skin burns.
- Avoid steam burns by directing steam away from the face and hands. Slowly lift the farthest edge of a dish's covering and carefully open popcorn and oven cooking bags away from the face.
- Stay near the microwave oven while it's in use and check cooking progress frequently so that there is no chance of overcooking food.
- NEVER use the cavity for storing cookbooks or other items.
- Select, store and handle food carefully to preserve its high quality and minimize the spread of foodborne bacteria.
- Keep waveguide cover clean. Food residue can cause arcing and/or fires.
- Use care when removing items from the microwave oven so that the utensil, your clothes or accessories do not touch the safety door latches.

PART NAMES & CONTROL PANEL

sensor cook	auto cook	auto reheat	auto defrost	snack menu	melt/soften
1 Frozen Entrees 2 Ground Meat 3 Rice 4 Chicken Breast 5 Fish/seafood	1 Pizza 2 Hot Dogs 3 Beverage	1 Fresh Rolls/Muffins 2 Frozen Rolls/Muffins 3 Pasta	1 Ground Meat 2 Steaks/Chops/Fish 3 Chicken Pieces 4 Roast 5 Casserole 6 Soup	1 Hand-held Snacks 3-4 oz 2 Hand-held Snacks 5-6 oz 3 Frozen Kid's Meal	1 Butter 2 Chocolate 3 Ice Cream 4 Cream Cheese

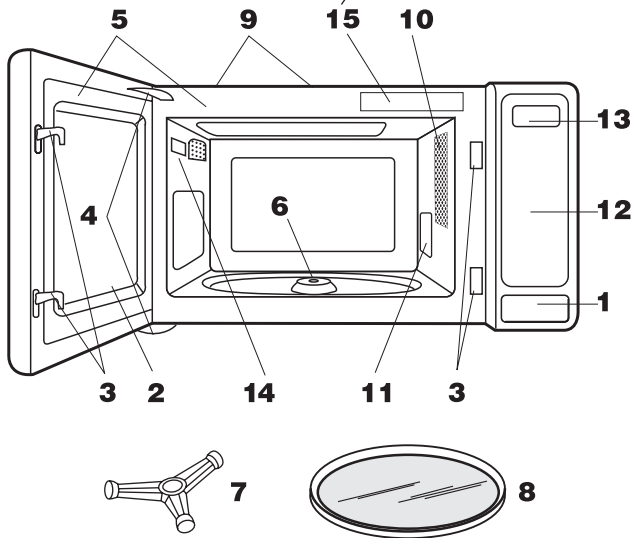

- 1 One touch door open button
Push to open door
- 2 Microwave Oven door with see-through window.
- 3 Safety door latches
The Microwave Oven will not operate unless the door is securely closed.
- 4 Door hinges
- 5 Door seals and sealing surfaces
- 6 Turntable motor shaft
- 7 Removable turntable support
Carefully place the turntable support in the center of the Microwave Oven floor.
- 8 Removable turntable
Place the turntable on the turntable support securely. The turntable will rotate clockwise or counterclockwise. Only remove for cleaning.
- 9 Ventilation openings (rear)
- 10 Microwave Oven light
It will light when Microwave Oven is operating or door is open.
- 11 Waveguide cover: DO NOT REMOVE.
- 12 Auto-Touch control panel
- 13 Time display: 99 minutes, 99 seconds
- 14 Serial plate
- 15 Menu Label

The 7-digit Interactive Display spells out operating steps and shows cooking hints. When HELP is lighted in the display, press the **user pref** pad to read a specific hint which may assist you.

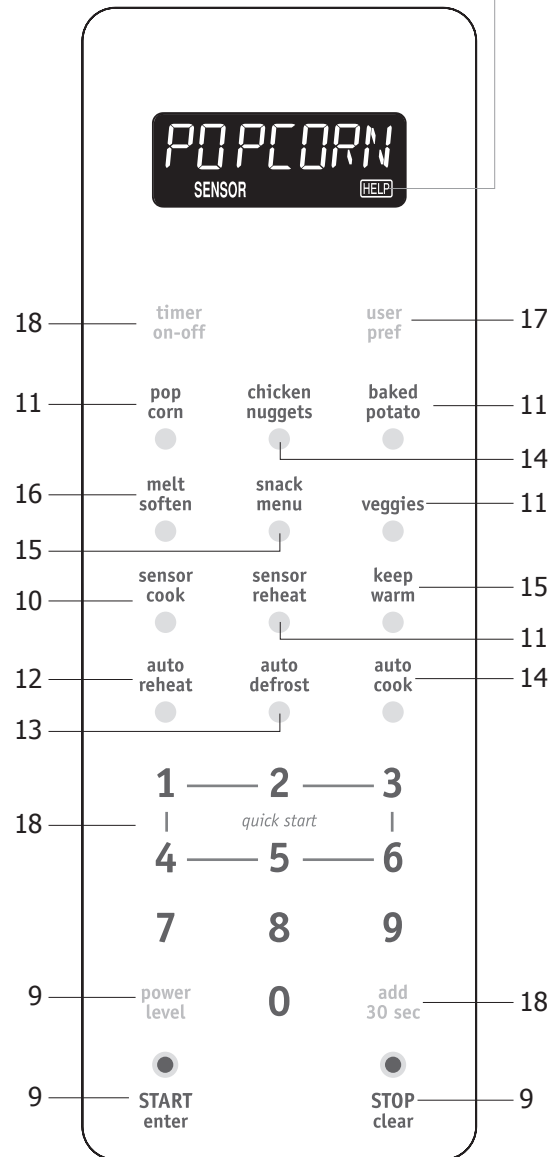

Number next to the control panel illustration indicates page on which there is a feature description and usage information.

NOTE

When a pad is pressed, an audible signal will be heard which confirms the pad has been pressed.

BEFORE OPERATING

- Before operating your new microwave oven, make sure you read and understand this Use and Care manual completely.
- Before the microwave oven can be used, follow these procedures:
 1. Plug in the microwave oven. Close the door. The microwave oven display will show *ENJOY YOUR OVEN PRESS CLEAR*.
 2. Press the **STOP/clear** pad. : will appear.
 3. Set clock. See USER PREFERENCE on page 17.
- If the electrical power supply to your microwave oven should be interrupted, the display will intermittently show *ENJOY YOUR OVEN PRESS CLEAR* after the power is reinstated. If this occurs during cooking, the program will be erased. The time of day will also be erased. Simply press **STOP/clear** pad and reset the clock for the correct time of day.

NOTE

Your microwave oven can be programmed with the door open except for **START/enter**, **SENSOR COOKING**, **SENSOR REHEAT**, **INSTANT SENSOR**, **AUTO DEFROST** and **ADD 30 SEC.**

STOP/CLEAR

Press the **STOP/clear** pad to:



1. Erase if you make a mistake during programming.
2. Cancel timer.
3. Stop the microwave oven temporarily during cooking.
4. Return the time of day to the display.
5. Cancel a program during cooking, press twice.

MANUAL OPERATION

TIME COOKING

Your microwave oven can be programmed for 99 minutes 99 seconds (99.99). Always enter the seconds after the minutes, even if they are both zeros.

- Suppose you want to cook for 5 minutes at 100%.



Step	Press
1. Enter cooking time 5,0,0 .	
2. Press START/enter pad.	

TO SET POWER LEVEL

There are eleven preset power levels. Using lower power levels increases the cooking time, which is recommended for foods such as cheese, milk and long slow cooking of meats. Consult cookbook or recipes for specific recommendations.

Press POWER LEVEL PAD NUMBER OF TIMES FOR DESIRED POWER	APPROXIMATE PERCENTAGE OF POWER	COMMON WORDS FOR POWER LEVELS
POWER LEVEL x 1	100%	High
POWER LEVEL x 2	90%	
POWER LEVEL x 3	80%	
POWER LEVEL x 4	70%	Medium High
POWER LEVEL x 5	60%	
POWER LEVEL x 6	50%	Medium
POWER LEVEL x 7	40%	
POWER LEVEL x 8	30%	Med Low/Defrost
POWER LEVEL x 9	20%	
POWER LEVEL x 10	10%	Low
POWER LEVEL x 11	0%	

- Suppose you want to defrost for 5 minutes at 30%.

Step	Press
1. Enter defrosting time. 5,0,0 .	
2. Press power level pad eight times or hold down until the desired power level appears.	 X 8
3. Press START/enter pad.	
4. When the defrost time is complete, a long tone will sound and <i>END</i> will appear in the display.	

MANUAL DEFROST

If the food that you wish to defrost is not listed on the DEFROST CHART or is above or below the limits in the Amount column on the DEFROST CHART, you need to defrost manually.

You can defrost any frozen food, either raw or previously cooked, by using **power level** for 30%. Follow the exact 3-step procedure found under TO SET POWER LEVEL. Estimate defrosting time and press **power level** pad eight times for 30%.

For either raw or previously cooked frozen food, the rule of thumb is approximately 4 minutes per pound. For example, defrost 4 minutes for 1 pound of frozen spaghetti sauce.

Always stop the microwave oven periodically to remove or separate the portions that are defrosted. If food is not defrosted at the end of the estimated defrosting time, program the microwave oven in 1 minute increments on **power level** 30% until totally defrosted.

When using plastic containers from the freezer, defrost only long enough to remove from the plastic in order to place in a microwave-safe dish.

SENSOR COOKING

SENSOR COOKING

Electrolux's Sensor is a semi-conductor device that detects the vapor (moisture and humidity) emitted from the food as it heats. The sensor adjusts the cooking times and power level for various foods and quantities.

Using Sensor Cooking:

1. After microwave oven is plugged in, wait 2 minutes before using SENSOR COOKING settings.
2. Be sure the exterior of the cooking container and the interior of the microwave oven are dry. Wipe off any moisture with a dry cloth or paper towel.
3. The microwave oven works with foods at normal storage temperature. For example, rice would be at room temperature.
4. Any Sensor Cooking selection can be programmed with MORE OR LESS TIME ADJUSTMENT. See page 18.
5. More or less food than the quantity listed in the chart should be cooked following the guidelines in any microwave cookbook.
6. During the first part of Sensor Cooking, food name will appear on the display. Do not open the microwave oven door or press **STOP/clear** during this part of the cooking cycle. The measurement of vapor will be interrupted. If this occurs, an error message will appear. To continue cooking, press the **STOP/clear** pad and cook manually.
When the sensor detects the vapor emitted from the food, remainder of cooking time will appear. Door may be opened when remaining cooking time appears on the display. At this time, you may stir or season food, as desired.
7. If the sensor does not detect vapor properly when popping popcorn, the oven will turn off, and the correct time of day will be displayed. If the sensor does not detect vapor properly when cooking other foods, *ERROR* will be displayed. Follow the instructions.

8. Check food for temperature after cooking. If additional time is needed, continue to cook manually.
9. INSTANT SENSOR and SENSOR REHEAT can only be entered within 3 minutes after cooking, opening and closing the door or pressing the **STOP/clear** pad.
10. Each food has a cooking hint. Press **user pref** pad when the HELP indicator is lighted in the display.

Covering Foods:

Some foods work best when covered. Use the cover recommended in the food charts.



1. Casserole lid.
2. Plastic wrap: Use plastic wrap recommended for microwave cooking. Cover dish loosely; allow approximately 1/2 inch to remain uncovered to allow steam to escape. Plastic wrap should not touch food.
3. Wax paper: Cover dish completely; fold excess wrap under dish to secure. If dish is wider than paper, overlap two pieces at least one inch to cover.

Be careful when removing any covering to allow steam to escape away from you.

EXAMPLE:

You can cook many foods by pressing the **sensor cook** pad and the food number. You don't need to calculate cooking time or power level.

- Suppose you want to cook ground meat.

Step	Press
1. Press sensor cook pad, number 2 for ground meat.	 
2. Press START/enter pad.	

When sensor detects the vapor emitted from the food, remainder of reheating time will appear.

SENSOR COOKING CHART

FOOD	AMOUNT	PROCEDURE
1. Frozen Entrees	6 - 17 oz	Use this pad for frozen convenience foods. It will give satisfactory results for most brands. You may wish to try several and choose your favorite. Remove package from outer wrapping and follow package directions for covering. After cooking, let stand, covered, for 1-3 minutes.
2. Ground Meat	0.25 - 2.0 lb	Use this setting to cook ground beef or turkey as patties or in a casserole to be added to other ingredients. Place patties on a microwave-safe rack and cover with wax paper. Place ground meat in a casserole and cover with wax paper or plastic wrap. When microwave oven stops, turn patties over or stir meat in casserole to break up large pieces. Re-cover and press START/enter . After cooking, let stand, covered, for 2 to 3 minutes.

SENSOR COOKING CHART

FOOD	AMOUNT	PROCEDURE															
3. Rice	0.5 - 2.0 cups	Place rice into a deep casserole and add double quantity of water. Cover with lid or plastic wrap. After cooking, stir, cover and let stand 3 to 5 minutes or until all liquid has been absorbed.															
		<table> <thead> <tr> <th>Rice</th> <th>Water</th> <th>Size of casserole</th> </tr> </thead> <tbody> <tr> <td>.5 cup</td> <td>1 cup</td> <td>1.5 quart</td> </tr> <tr> <td>1 cup</td> <td>2 cups</td> <td>2 quart</td> </tr> <tr> <td>1.5 cups</td> <td>3 cups</td> <td>2.5 or 3 quart</td> </tr> <tr> <td>2 cups</td> <td>4 cups</td> <td>3 quart or larger</td> </tr> </tbody> </table>	Rice	Water	Size of casserole	.5 cup	1 cup	1.5 quart	1 cup	2 cups	2 quart	1.5 cups	3 cups	2.5 or 3 quart	2 cups	4 cups	3 quart or larger
Rice	Water	Size of casserole															
.5 cup	1 cup	1.5 quart															
1 cup	2 cups	2 quart															
1.5 cups	3 cups	2.5 or 3 quart															
2 cups	4 cups	3 quart or larger															
4. Chicken Breasts	0.5 - 2.0 lb	Cover with vented plastic wrap. When microwave oven stops, turn over. Shield with small, flat pieces of aluminum foil any areas that are cooking too rapidly. Re-cover and press START/enter . After cooking, let stand, covered for 3-5 minutes. Chicken should be 160°F.															
5. Fish Seafood	0.25 - 2.0 lb	Arrange in ring around shallow glass dish (roll fillet with edges underneath). Cover with vented plastic wrap. After cooking, let stand, covered for 3 minutes.															

INSTANT SENSOR

Instant sensor buttons allow you to cook or reheat by pressing just one pad.

- Suppose you want to cook a baked potato.

Step	Press
Press baked potato pad. The microwave oven starts automatically.	

INSTANT SENSOR CHART

FOOD	AMOUNT	PROCEDURE
Baked Potato	1 - 8 med.	Pierce with fork in several places. Place on paper towel on turntable. After cooking, remove from oven and let stand wrapped in foil for 5 to 10 minutes.
Popcorn	1 package 1.5 - 3.5 oz bag	Use only popcorn packaged for microwave oven use. Try several brands to decide which you like. Do not try to pop unpopped kernels.
Veggies	0.25 - 2.0 lb 0.25 - 2.0 lb 0.25 - 1.25 lb	Press veggies pad once for soft veggies. Press veggies pad twice for hard veggies. Press veggies pad three times for frozen veggies.

SENSOR REHEAT

You can reheat many foods and don't need to calculate cooking time or power level.

Step	Press
Press sensor reheat and after 2 seconds, it will automatically start.	
When the sensor detects the vapor emitted from the food, the remainder of cooking/reheating time will appear.	

SENSOR REHEAT CHART



FOOD	AMOUNT	PROCEDURE
Sensor Reheat	4-36 oz.	Place in dish or casserole slightly larger than amount to be reheated. Flatten, if possible. Cover with lid, plastic wrap or wax paper. Use covers such as plastic wrap or lids with larger quantities of more dense foods such as stews. After reheating, stir well, if possible. Re-cover and allow to stand 2 to 3 minutes. Foods should be very hot. If not, continue to heat with variable power and time.

AUTO COOKING

AUTO REHEAT

AUTO REHEAT automatically computes the correct warming and heating time and microwave power level for foods shown in the chart below.

- Suppose you want to heat 2 fresh rolls or muffins.

Step	Press
1. Press auto reheat .	
2. Press 1 for fresh rolls or muffins. Then press 2 for 2 fresh rolls or muffins.	 
3. Press START/enter .	

NOTES

1. AUTO REHEAT can be programmed with MORE or LESS TIME ADJUSTMENT. See page 18.
2. The final result will vary according to the food condition (e.g. initial temperature, shape, quality). Check food for temperature after heating. If additional time is needed, continue to heat manually.







AUTO REHEAT CHART

FOOD	AMOUNT	PROCEDURE
1. Fresh Rolls/ Muffins	1 - 10 pieces	Use this pad to warm rolls, muffins, biscuits, bagels etc. Large items should be considered as 2 or 3 regular size. Arrange on plate; cover with paper towel. For refrigerated rolls or muffins, it may be necessary to double the entered amount to ensure the proper serving temperature. For example, enter quantity of 2 for 1 refrigerated muffin.
2. Frozen Rolls/ Muffins	1 - 10 pieces	Use this pad to warm frozen rolls, muffins, biscuits, bagels, etc. Large items should be considered as 2 or 3 regular size. Arrange on plate, cover with paper towel.
3. Pasta	1.0 - 6.0 cups	Use this pad to reheat refrigerated canned or homemade pasta with sauce. For room temperature pastas, use LESS option. Pasta without sauce double the quantity per setting. For example, measure 2 cups of cooked noodles and program for 1 cup. Cover with lid or plastic wrap. Press auto reheat pad 3 times. Enter the desired number of cups and press START/enter . After cooking, let stand, covered, 2 to 3 minutes.

AUTO DEFROST

AUTO DEFROST automatically defrosts all the foods found in the AUTO DEFROST chart below.

- Suppose you want to defrost a 2.0 pound steak.

Step	Press
1. Press auto defrost and 2 for Steak/Chops/Fish.	 , 
2. Enter weight.	 
3. Press START/enter . The oven will stop so the food can be checked.	
4. After the 1st stage, open the door. Turn steak over and shield any warm portions. Close the door. Press START pad.	
5. After the 2nd stage, open the door. Shield any warm portions. Close the door. Press START pad.	
6. After defrost cycle ends, let stand, covered.	

NOTES

1. If you attempt to enter more or less than the allowed weight as indicated in chart, *ERROR* will appear in the display.
2. AUTO DEFROST can be programmed with MORE OR LESS TIME ADJUSTMENT. See page 18.
3. To defrost other foods or foods above or below the weights allowed on AUTO DEFROST CHART use time and 30% power. See MANUAL DEFROST on page 9.
4. You may choose to enter the weight in tenths of pounds. This procedure may be easier with larger weights, such as 3 pounds, because it requires fewer touches. To program, press desired food number and enter weight. Ex: press **Steaks/Chops/Fish** then **3** and **0** for a weight of three pounds or press **Steaks/Chops/Fish** then **2** and **2** for a weight of 2.2 lb.
5. Press **user pref** pad when the HELP indicator is lighted in the display for a helpful hint.
6. Check foods when oven signals. After final stage, small sections may still be icy. Let stand to continue thawing. Do not defrost until all ice crystals thawed.
7. Shielding prevents cooking from occurring before the center of the food is defrosted. Use small smooth strips of aluminum foil to cover edges and thinner sections of the food.

AUTO DEFROST CHART





FOOD	AMOUNT	PROCEDURE
1. Ground Meat	0.5 - 3.0 lb	Remove any thawed pieces after each stage. Let stand, covered, for 5 to 10 minutes.
2. Steaks/Chops/Fish	0.5 - 4.0 lb	After each stage, rearrange and if there are warm or thawed portions, shield with small flat pieces of aluminum foil. Remove any meat or fish that is nearly defrosted. Let stand, covered, for 10 to 20 minutes.
3. Chicken Pieces	0.5 - 3.0 lb	After each stage, if there are warm or thawed portions, rearrange or remove. Let stand, covered, for 10 to 20 minutes.
4. Roast	2.0 - 4.0 lb	Start defrosting with fat side down. After each stage, turn roast over and shield the warm portions with aluminum foil. Let stand, covered, for 30-60 minutes.
5. Casserole	2 - 6 cups	After audible signal, stir if possible. At end, stir well and let stand, covered, for 5 to 10 minutes.
6. Soup	1 - 6 cups	After audible signal, stir if possible. At end, stir well and let stand, covered, for 5 to 10 minutes.

AUTO COOKING

AUTO COOK

AUTO COOK computes the correct cooking time and microwave power level for foods shown in the chart below.

- Suppose you want to cook 1 slice of pizza.

Step	Press
1. Press auto cook and 1 for pizza.	 
2. Enter quantity.	
3. Press START/enter .	

TIPS: Food can be covered with wax paper or vented plastic wrap. Temperatures of foods covered with plastic wrap tend to be slightly higher than those covered with wax paper.

NOTES



1. More or less food than the quantity listed in the chart should be cooked following the guidelines in any microwave cookbook. Press the power level pad once or twice before pressing **START/enter**.
2. AUTO COOK can be programmed with MORE or LESS TIME ADJUSTMENT. See page 18.
3. The final cooking result will vary according to the food condition (e.g. initial temperature, shape, quality). Check food for temperature after heating. If additional time is needed, continue to heat manually.
4. Each food has a cooking hint. Press **user pref** pad when the HELP indicator is lighted in the display.

AUTO COOK CHART

FOOD	AMOUNT	PROCEDURE
1. Pizza	1 - 6 slices	Use this setting to reheat refrigerated leftover pizza. One slice is approximately 1/8 th of an 12-inch pizza or 1/16 th of a 16-inch pizza. if possible, place on paper towel on a microwave-safe rack. Press auto cook and the number 1 . Enter number of slices. Press START/enter .
2. Hot Dogs	1 - 6	Place hot dog in bun. Wrap each with paper towel or napkin. Press auto cook and the number 2 . Enter the quantity of hot dogs and press START/enter .
3. Beverage	0.5 - 2.0 cups	This setting is good for restoring cooled beverage to a better drinking temperature. Stir liquid briskly before and after heating to avoid "eruption". Press auto cook and the number 3 . Enter the quantity of cups and press START/enter .

CHICKEN NUGGETS

- Suppose you want to heat 0.3 pounds of chicken nuggets with snacks.

Step	Press
1. Press chicken nugget pad.	
2. Enter amount by pressing the number 3 .	
3. Press START/enter .	

NOTE

When 1.0 pound chicken nuggets is heated, press number **1** and **0** at Step 2.

CHICKEN NUGGETS CHART



FOOD	AMOUNT	PROCEDURE
Chicken Nuggets	0.3 - 1.0 lb	Place frozen chicken nuggets on a flat plate allowing space between each, cover food with paper towel. Press chicken nugget pad. Enter weight and touch START/enter . After cooking, open door, rearrange, close door and press START/enter . Let stand, covered, for 1 to 3 minutes.

KEEP WARM

KEEP WARM allows you to keep food warm up to 30 minutes.

DIRECT USE





- Suppose you want to keep a cup of soup warm for 15 minutes.

Step	Press
1. Press keep warm .	
2. Enter time 1,5,0,0 .	
3. Press START/enter .	

The microwave oven will start. The display will show *15.00* and count down. *KEEP WARM* will be displayed during the count down. You can program KEEP WARM with manual cooking to keep food warm continuously after cooking.

WITH MANUAL COOKING

- Suppose you want to cook a cup of soup for 2 minutes at 70% and keep the soup warm for 15 minutes.

Step	Press
1. Enter cooking time 2,0,0 .	
2. Press power level pad 4 times for 70% power.	
3. Press keep warm pad.	
4. Enter time 1,5,0,0 .	
5. Press START/enter pad.	

The operation will start. When the cooking time is complete, a long tone will sound and KEEP WARM will start. The display will count down for 15 minutes and *KEEP WARM* will be displayed.



NOTE

KEEP WARM cannot be programmed with CONVENIENT FEATURES.

SNACK MENU

SNACK MENU automatically computes the correct heating time and microwave power level for foods shown in the chart below.

- Suppose you want to cook a 3 oz hand-held snack.

Step	Press
1. Press snack menu .	
2. Press 1 for 3 - 4 oz hand-held snack.	
3. Press START/enter .	

NOTE

SNACK MENU can be programmed with MORE or LESS TIME ADJUSTMENT. See page 18.

SNACK MENU CHART





FOOD	AMOUNT	PROCEDURE
1. Hand-held Snacks	3 - 4 oz	Press snack menu pad and number 1 for hand-held snacks. Press START/enter .
2. Hand-held Snacks	5 - 6 oz	Press snack menu pad and number 2 for hand-held snacks. Press START/enter .
3. Frozen Kid's Meal	6 - 8 oz	Press snack menu pad and number 3 for frozen kid's meal. Press START/enter .

AUTO COOKING

MELT/SOFTEN

MELT/SOFTEN automatically computes the correct heating time and microwave power level for melting and softening foods shown in the chart below.

- Suppose you want to soften 2 tablespoons of butter.

Step	Press
1. Press melt/soften and 1 for butter.	 
2. Press 1 for 2 tablespoons.	
3. Press START/enter .	

NOTES

1. MELT/SOFTEN can be programmed with MORE OR LESS TIME ADJUSTMENT. See page 18.
2. To melt or soften other foods above or below the quantity allowed on the MELT/SOFTEN Chart, use manual operation.

MELT/SOFTEN CHART

FOOD	AMOUNT	PROCEDURE
MELT		
1. Butter	2 tbsp	Use a Pyrex measuring cup. Cover with plastic wrap. After pressing melt , press number 1 once for 2 tbsp.
	1/2 cup	After pressing melt , press number 1 twice for 1/2 cup.
2. Chocolate	1 cup chips	After pressing melt , press number 2 once for 1 cup chips.
	1 square	After pressing melt , press number 2 twice for 1 square.
SOFTEN		
3. Ice Cream	1 pint	DO NOT COVER. After pressing soften , press number 3 once for 1 pint.
	1/2 gallon	After pressing soften , press number 3 twice for 1/2 gallon.
4. Cream Cheese	3 oz	After pressing soften , press number 4 once for 3 oz.
	8 oz	After pressing soften , press number 4 twice for 8 oz.

USER PREFERENCE

USER PEF provides 5 features that make using your microwave oven easy because specific instructions are provided in the interactive display.

1. Child Lock

The Child Lock prevents unwanted oven operation such as by small children. The oven can be set so that the control panel is deactivated or locked. To set, press **user pref**, the number **1** and then press the **START/enter** pad. Should a pad be touched, *LOCKED* will appear in the display. To cancel, press **user pref** and **START/enter** pad.













2. Audible Signal Elimination

If you wish to have the microwave oven operate with no audible signals, press **user pref**, the number **2** and then press the **STOP/clear** pad. To cancel, press **user pref** and **START/enter** pad.

3. Auto Start

If you wish to program your microwave oven to begin cooking automatically at a designated time of day, follow this procedure:

- Suppose you want to start cooking a stew for 40 minutes on 50% at 4:30. Before setting, check to make sure the clock is showing the correct time of day.

Step	Press
1. Press user pref and the number 3 .	 
2. Enter number 4,3,0 for start time.	  
3. Press START/enter .	
4. Enter cook time. 4,0,0,0 .	   
5. Press power level pad six times for 50% power.	 x 6
6. Press START/enter or power level .	

NOTES

- AUTO START can be used for manual cooking if clock is set.
- If the microwave oven door is opened after programming AUTO START, it is necessary to press the **START/enter** pad for AUTO START time to appear in the readout so that the microwave oven will automatically begin programmed cooking at the chosen AUTO START time.
- Be sure to choose foods that can be left in the microwave oven safely until the AUTO START time. Acorn or butternut squash are often a good choice.







4. Language / Weight Selection

The microwave oven comes set for English and U.S. Customary Unit-pounds. To change, press **user pref** and the number **4**. Press the number **4** until your choice is selected from the table below. Then, press **START/enter**.

Press user pref and the number 4	Language	Units
once	English	LB
twice	English	KG
3 times	Spanish	LB
4 times	Spanish	KG
5 times	French	LB
6 times	French	KG

5. To Set the Clock

- Suppose you want to enter the correct time of day, 12:30 (AM or PM).

Step	Press
1. Press user pref and the number 5 .	 
2. Enter time 1, 2, 3, 0 .	   
3. Press START/enter .	

This is a 12 hour clock. If you attempt to enter an incorrect clock time, *ERROR* will appear in the display. Press **STOP/clear** and re-enter the time.

CONVENIENT FEATURES

HELP (In display)



Whenever HELP is lighted in the Interactive Display, press **user pref** to read cooking and operating hints.

MULTIPLE SEQUENCE COOKING

Your microwave oven can be programmed for up to 4 automatic cooking sequences, switching from one power level setting to another automatically.

Sometimes cooking directions tell you to start on one power level and then change to a different power level. Your microwave oven can do this automatically.

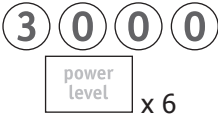
- Suppose you want to cook roast beef for 5 minutes at 100% and then continue to cook for 30 minutes at 50%.

Step	Press
1. First enter cooking time. Then press power level pad once for 100% power.	
2. Enter second cooking time. Press power level pad 6 times for 50% power.	
3. Press START/enter .	

NOTES

- If you wish to know power level, simply press the **power level** pad. As long as your finger is pressing the **power level** pad, the power level will be displayed.
- If 100% is selected as the final sequence, it is not necessary to press the **power level** pad.

ADD 30 SEC

ADD 30 SEC allows you to cook for 30 seconds at 100% by simply pressing the **add 30 sec** pad. You can also extend cooking time in multiples of 30 seconds by repeatedly pressing the **add 30 sec** pad during manual cooking.

NOTES

- To use **add 30 sec**, press pad within 3 minutes after cooking, closing the door, pressing the **STOP/clear** pad or during cooking.
- ADD 30 SEC cannot be used with SENSOR COOKING or AUTO COOKING.

QUICK START

QUICK START is a short-cut method to set time for 1-6 minutes at power level 10.

- Suppose you want to heat a cup of soup for two minutes.

Step	Press
1. Press number 2 pad.	

The oven will start immediately and will signal then turn off automatically when finished.

NOTE

To use **quick start**, press pads within 3 minutes after cooking, closing the door, pressing the **STOP/clear** pad or during cooking.

DEMONSTRATION MODE

To demonstrate, press **user pref**, the number **5**, the number **0** and then press **START/enter** and hold for three seconds. *DEMO ON* will appear in the display. Cooking operations and specific special features can now be demonstrated with no power in the oven. For example, press **add 30 sec** pad and the display will show *:30* and count down quickly to *END*.

To cancel, press **user pref**, the number **5**, the number **0** and then **STOP/clear** pads. If easier, unplug the oven from the electrical outlet and replug and set clock.



MORE OR LESS TIME ADJUSTMENT

Should you discover that you like any of the SENSOR COOKING or AUTO COOKING settings slightly **more** done, press the **power level** pad once after pressing your choice of pads. The display will show *MORE*.

For slightly **less** done, press the **power level** pad twice after pressing your choice of pads. The display will show *LESS*.

TIMER ON/OFF

- Suppose you want to time a 3 minute long distance phone call.

Step	Press
1. Press timer on/off pad.	
2. Press 3,0,0 to enter time.	
3. Press timer on/off pad. The timer will count down. To cancel the timer, press the STOP/clear pad once.	

Disconnect the power cord before cleaning or leave the door open to deactivate the oven during cleaning.

EXTERIOR

The outside surface is precoated steel and plastic. Clean the outside with mild soap and water; rinse and dry with a soft cloth. Do not use any type of household or abrasive cleaner.

DOOR

Wipe the window on both sides with a damp cloth to remove any spills or spatters. Metal parts will be easier to maintain if wiped frequently with a damp cloth. Cleaners which are marked specifically for use with stainless steel may be used. Follow package directions exactly. Avoid the use of any harsh cleaner or one not marked for stainless steel use as they may stain, streak or dull the door surface.

EASY CARE™ STAINLESS STEEL (SOME MODELS)

Your microwave oven finish may be made with Easy Care™ Stainless Steel (some models). Clean the stainless with warm soapy water using a clean sponge or cloth. Rinse with clean water and dry with a soft clean cloth. DO NOT use ANY store bought cleaners like Stainless Steel cleaners or any other types of cleaners containing any abrasive, chlorides, chlorines or ammonia. It is recommended to use mild dish soap and water or a 50/50 solution of water and vinegar.

TOUCH CONTROL PANEL

Care should be taken in cleaning the touch control panel. If the control panel becomes soiled, open the microwave oven door before cleaning. Wipe the panel with a cloth dampened slightly with water only. Dry with a soft cloth. Do not scrub or use any sort of chemical cleaners. Close door and press **STOP/clear**.

INTERIOR

Cleaning is easy because little heat is generated to the interior surfaces; therefore, there is no baking and setting of spills or spattering. To clean the interior surfaces, wipe with a soft cloth and warm water. DO NOT USE ABRASIVE OR HARSH CLEANERS OR SCOURING PADS. For heavier soil, use baking soda or a mild soap; rinse thoroughly with hot water.

WAVEGUIDE COVER

The waveguide cover is made from mica so requires special care. Keep the waveguide cover clean to assure good microwave oven performance. Carefully wipe with a damp cloth any food spatters from the surface of the cover immediately after they occur. Built-up splashes may overheat and cause smoke or possibly catch fire. DO NOT REMOVE THE WAVEGUIDE COVER.

ODOR REMOVAL

Occasionally, a cooking odor may remain in the microwave oven. To remove, combine 1 cup water, grated peel and juice of 1 lemon and several whole cloves in a 2-cup glass measuring cup. Boil for several minutes using 100% power. Allow to set in microwave oven until cool. Wipe interior with a soft cloth.

TURNTABLE/TURNTABLE SUPPORT

The turntable and turntable support can be removed for easy cleaning. Wash them in mild, sudsy water; for stubborn stains use a mild cleanser and non abrasive scouring sponge. They are also dishwasher-proof. Use upper rack of dishwasher. The turntable motor shaft is not sealed, so excess water or spills should be wiped up immediately.

SERVICE CALL CHECK

Please check the following before calling for service:

Place one cup of water in a glass measuring cup in the microwave oven and close the door securely.

Operate the microwave oven for one minute at HIGH 100%.

- A Does the microwave oven light come on?
YES _____ NO _____
- B Does the cooling fan work? (Put your hand over the rear ventilation openings.)
YES _____ NO _____
- C Does the turntable rotate? (It is normal for the turntable to turn in either direction.)
YES _____ NO _____
- D Is the water in the microwave oven warm?
YES _____ NO _____

If "NO" is the answer to any of these questions, please check electrical outlet, fuse and/or circuit breaker. If they are functioning properly, CONTACT YOUR NEAREST Electrolux AUTHORIZED SERVICER.

A microwave oven should never be serviced by a "do-it-yourself" repair person.

NOTE

If time appearing in the display is counting down very rapidly, check DEMONSTRATION MODE on page 18 and cancel.

SPECIFICATIONS

FPMO209KF, CPMO209KF, FGMO205KF, CGMO205KF, FGMO205KB, FGMO205KW

AC Line Voltage:	UL Rating - Single phase 120V, 60Hz, AC only (FPMO209, FGMO205) CUL Rating - Single phase 120V, 60Hz, AC only (CPMO209, CGMO205)
AC Power Required:	UL Rating - 1700W 14.2 amps. (FPMO209, FGMO205) CUL Rating - 1500W 13.0 amps. (CPMO209, CGMO205)
Output Power*:	UL - FPMO209, FGMO205: 1200W CUL - CPMO209, CGMO205: 1100W
Frequency:	2450 MHz
Outside Dimensions:	24"(W) x 13-3/8"(H) x 19-1/8"(D)
Cavity Dimensions:	17-3/8"(W) x 10-1/2"(H) x 18-5/8"(D)
Microwave oven Capacity**:	2.0 Cu.Ft.
Cooking Uniformity:	Turntable
Weight:	Approx. 46 LB

* The International Electrotechnical Commission's standardized method for measuring output wattage. This test method is widely recognized.

** Internal capacity is calculated by measuring maximum width, depth and height. Actual capacity for holding food is less.

In compliance with standards set by:

FCC – Federal Communications Commission Authorized.

DHHS – Complies with Department of Health and Human Services (DHHS) rule, CFR, Title 21, Chapter I, Subchapter J.

NHW – Department of National Health and Welfare of Canada.



– This symbol on the nameplate means the product is listed by Underwriters Laboratories, Inc.



– This symbol on the nameplate means the product is listed by Underwriters Laboratories, Inc. for use in USA or Canada.

This microwave oven is listed by the Canadian Standard Association as certified (CPMO209 and CGMO205).

MAJOR APPLIANCE WARRANTY INFORMATION

Your appliance is covered by a one year limited warranty. For one year from your original date of purchase, Electrolux will pay all costs for repairing or replacing any parts of this appliance that prove to be defective in materials or workmanship when such appliance is installed, used, and maintained in accordance with the provided instructions.

Exclusions **This warranty does not cover the following:**

1. Products with original serial numbers that have been removed, altered or cannot be readily determined.
2. Product that has been transferred from its original owner to another party or removed outside the USA or Canada.
3. Rust on the interior or exterior of the unit.
4. Products purchased "as-is" are not covered by this warranty.
5. Food loss due to any refrigerator or freezer failures.
6. Products used in a commercial setting.
7. Service calls which do not involve malfunction or defects in materials or workmanship, or for appliances not in ordinary household use or used other than in accordance with the provided instructions.
8. Service calls to correct the installation of your appliance or to instruct you how to use your appliance.
9. Expenses for making the appliance accessible for servicing, such as removal of trim, cupboards, shelves, etc., which are not a part of the appliance when it is shipped from the factory.
10. Service calls to repair or replace appliance light bulbs, air filters, water filters, other consumables, or knobs, handles, or other cosmetic parts.
11. Surcharges including, but not limited to, any after hour, weekend, or holiday service calls, tolls, ferry trip charges, or mileage expense for service calls to remote areas, including the state of Alaska.
12. Damages to the finish of appliance or home incurred during installation, including but not limited to floors, cabinets, walls, etc.
13. Damages caused by: services performed by unauthorized service companies; use of parts other than genuine Electrolux parts or parts obtained from persons other than authorized service companies; or external causes such as abuse, misuse, inadequate power supply, accidents, fires, or acts of God.

DISCLAIMER OF IMPLIED WARRANTIES; LIMITATION OF REMEDIES

CUSTOMER'S SOLE AND EXCLUSIVE REMEDY UNDER THIS LIMITED WARRANTY SHALL BE PRODUCT REPAIR OR REPLACEMENT AS PROVIDED HEREIN. CLAIMS BASED ON IMPLIED WARRANTIES, INCLUDING WARRANTIES OF MERCHANTABILITY OR FITNESS FOR A PARTICULAR PURPOSE, ARE LIMITED TO ONE YEAR OR THE SHORTEST PERIOD ALLOWED BY LAW, BUT NOT LESS THAN ONE YEAR. Electrolux SHALL NOT BE LIABLE FOR CONSEQUENTIAL OR INCIDENTAL DAMAGES SUCH AS PROPERTY DAMAGE AND INCIDENTAL EXPENSES RESULTING FROM ANY BREACH OF THIS WRITTEN LIMITED WARRANTY OR ANY IMPLIED WARRANTY. SOME STATES AND PROVINCES DO NOT ALLOW THE EXCLUSION OR LIMITATION OF INCIDENTAL OR CONSEQUENTIAL DAMAGES, OR LIMITATIONS ON THE DURATION OF IMPLIED WARRANTIES, SO THESE LIMITATIONS OR EXCLUSIONS MAY NOT APPLY TO YOU. THIS WRITTEN WARRANTY GIVES YOU SPECIFIC LEGAL RIGHTS. YOU MAY ALSO HAVE OTHER RIGHTS THAT VARY FROM STATE TO STATE.

If You Need Service Keep your receipt, delivery slip, or some other appropriate payment record to establish the warranty period should service be required. If service is performed, it is in your best interest to obtain and keep all receipts. Service under this warranty must be obtained by contacting Electrolux at the addresses or phone numbers below.

This warranty only applies in the USA and Canada. In the USA, your appliance is warranted by Electrolux Major Appliances North America, a division of Electrolux Home Products, Inc. In Canada, your appliance is warranted by Electrolux Canada Corp. Electrolux authorizes no person to change or add to any obligations under this warranty. Obligations for service and parts under this warranty must be performed by Electrolux or an authorized service company. Product features or specifications as described or illustrated are subject to change without notice.

USA
1.800.944.9044
Electrolux Major Appliances
North America
P.O. Box 212378
Augusta, GA 30907



Canada
1.800.265.8352
Electrolux Canada Corp.
5855 Terry Fox Way
Mississauga, Ontario, Canada
L5V 3E4

Free Manuals Download Website

<http://myh66.com>

<http://usermanuals.us>

<http://www.somanuals.com>

<http://www.4manuals.cc>

<http://www.manual-lib.com>

<http://www.404manual.com>

<http://www.luxmanual.com>

<http://aubethermostatmanual.com>

Golf course search by state

<http://golfingnear.com>

Email search by domain

<http://emailbydomain.com>

Auto manuals search

<http://auto.somanuals.com>

TV manuals search

<http://tv.somanuals.com>