

---

# OWNER'S GUIDE

---

READ AND SAVE THESE INSTRUCTIONS

# ELECTRIC RANGE

COIL SURFACE ELEMENTS  
SELF-CLEANING OVEN MODELS

---

P/N 316000635 (9703)

## Product Registration

### Register Your Product

The self-addressed **PRODUCT REGISTRATION CARD** should be filled in completely, signed and returned to Frigidaire Company.

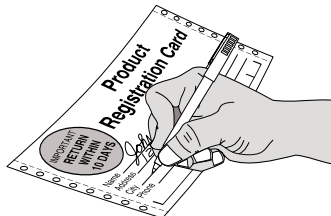

**Thank you for choosing this appliance.** The information contained within this **Owner's Guide** will instruct you on how to properly operate and care for your range. Please read through the information contained in your literature pack to learn more about your new appliance.

### Record Your Model and Serial Numbers

Record in the space provided below the model and serial numbers found on the serial plate located under the lift-up cooktop.

**Model Number:** \_\_\_\_\_

**Serial Number:** \_\_\_\_\_

**Date of Purchase:** \_\_\_\_\_

## Contents

This Owner's Guide contains general operating instructions for your range and feature information for several models. Your range **may not** have all the described features.

**Note:** The instructions appearing in this Owner's Guide are not meant to cover every possible condition and situation that may occur. Common sense and caution must be practiced when installing, operating and maintaining any appliance.

### Versión en español

Si desea obtener una copia en español de este Manual del Usuario, sírvase escribir a la dirección que se incluye a continuación. Solicite la P/N 316080257.

Spanish Owner's Guides  
Frigidaire Company  
P.O. Box 9061  
Dublin, Ohio 43017-0961

2	Versión en español
3-4	Important Safety Instructions
5	Control Pad Functions
6	Setting the Clock and Minute Timer
7	Setting Surface Controls
8	Before Setting Oven Controls
9-11	Setting Oven Controls
12-13	Oven Cleaning
14-15	General Cleaning
16	Changing Cooktop and/or Oven Lights (some models)
17	Adjusting Oven Temperature
18-19	Avoid Service Checklist
20	Warranty

# IMPORTANT SAFETY INSTRUCTIONS

Read all instructions before using this appliance.

Save these instructions for future reference.

This guide contains important safety symbols and instructions. Please pay special attention to these symbols and follow all instructions given. Here is a brief explanation of the use of these symbols.

**⚠ WARNING** This symbol will help alert you to situations that may cause serious bodily harm, death or property damage.

**⚠ CAUTION** This symbol will help alert you to situations that may cause bodily injury or property damage.

- **Remove all tape and packaging wrap before using the range. Destroy the carton and plastic bags after unpacking the range.** Never allow children to play with packaging material.
- **Proper Installation—Be sure your appliance is properly installed and grounded by a qualified technician in accordance with the National Electrical Code ANSI/NFPA No. 70—latest edition and local code requirements.** Install only per installation instructions provided in the literature package for this range.

Ask your dealer to recommend a qualified technician and an authorized repair service. Know how to disconnect the electrical power to the range at the circuit breaker or fuse box in case of an emergency.

- **User Servicing—Do not repair or replace any part of the appliance unless specifically recommended in the manuals.** All other servicing should be done only by a qualified technician to reduce the risk of personal injury and damage to the range.
- **Never modify or alter the construction of a range by removing leveling legs, panels, wire covers, anti-tip brackets/screws, or any other part of the product.**

- **Storage in or on Appliance—Flammable materials should not be stored in an oven, near surface elements or in the storage drawer (if equipped).** This includes paper, plastic and cloth items, such as cookbooks, plasticware and towels, as well as flammable liquids. Do not store explosives, such as aerosol cans, on or near the range. Flammable materials may explode and result in fire or property damage.

- **Do not leave children alone. Children should not be left alone or unattended in the area where an appliance is in use.** They should never be allowed to sit or stand on any part of the appliance.

- **DO NOT TOUCH SURFACE UNITS, AREAS NEAR THESE UNITS, HEATING ELEMENTS OR INTERIOR SURFACES OF THE OVEN.** Both surface units and oven heating elements may be hot even though they are dark in color. Areas near surface units may become hot enough to cause burns. During and after use, do not touch, or let clothing or other flammable materials touch these areas until they have had sufficient time to cool. Among these areas are the cooktop, surfaces facing the cooktop, the oven vent openings and surfaces near these openings, oven door and window.

- **Wear Proper Apparel—Loose-fitting or hanging garments should never be worn while using the appliance.** Do not let clothing or other flammable materials contact hot surfaces.

**⚠ WARNING** Never use your appliance for warming or heating the room.

- **Do Not Use Water or Flour on Grease Fires—Smother the fire with a pan lid, or use baking soda, a dry chemical or foam-type extinguisher.**
- **When heating fat or grease, watch it closely.** Fat or grease may catch fire if allowed to become too hot.
- **Use Only Dry Potholders—Moist or damp potholders on hot surfaces may result in burns from steam.** Do not let the potholders touch hot heating elements. Do not use a towel or other bulky cloth instead of a potholder.
- **Do Not Heat Unopened Food Containers—Build-up of pressure may cause the container to burst and result in injury.**
- **Remove the oven door from any unused range if it is to be stored or discarded.**
- **IMPORTANT—Do not attempt to operate the range during a power failure. If the power fails, always turn off the range.** If the range is not turned off and the power resumes, the range will begin to operate again. Food left unattended could catch fire or spoil.

**⚠ CAUTION** Cold temperatures can damage the electronic control. When using the appliance for the first time, or when the appliance has not been used for an extended period of time, be certain the unit has been in temperatures above 32°F for at least 3 hours before turning on the power to the appliance.



**⚠ WARNING**

- ALL RANGES CAN TIP.
- INJURY TO PERSONS COULD RESULT.
- INSTALL ANTI-TIP DEVICE PACKED WITH RANGE.
- SEE INSTALLATION INSTRUCTIONS.

**⚠ WARNING**

TO REDUCE THE RISK OF TIPPING OF THE RANGE, THE RANGE MUST BE SECURED BY PROPERLY INSTALLED ANTI-TIP BRACKET(S) PROVIDED WITH THE RANGE. TO CHECK IF THE BRACKET(S) IS INSTALLED PROPERLY, REMOVE THE LOWER PANEL OR STORAGE DRAWER AND VERIFY THAT THE ANTI-TIP BRACKET(S) IS ENGAGED. REFER TO THE INSTALLATION INSTRUCTIONS FOR PROPER ANTI-TIP BRACKET(S) INSTALLATION.

**⚠ WARNING** Stepping, leaning or sitting on the doors or drawers of this range can result in serious injuries and may also cause damage to the range. Do not allow children to climb or play around the range. The weight of a child on an open door may cause the range to tip, resulting in serious burns or other injury.

**⚠ WARNING** Do not use the oven for storage.

**⚠ CAUTION** Do not store items of interest to children in the cabinets above a range or on the backguard of a range. Children climbing on the range to reach items could be seriously injured.

# IMPORTANT SAFETY INSTRUCTIONS (continued)

## IMPORTANT INSTRUCTIONS FOR USING YOUR COOKTOP

- **Know which knob controls each surface heating element.**
- **Use Proper Pan Size**—This appliance is equipped with one or more surface elements of different sizes. Select utensils having flat bottoms large enough to cover the surface unit heating element. The use of undersized utensils will expose a portion of the heating element to direct contact and may result in ignition of clothing. Proper relationship of utensil to element will also improve efficiency.
- **Utensil Handles Should Be Turned Inward and Not Extend Over Adjacent Surface Elements**—To reduce the risk of burns, ignition of flammable materials, and spillage due to unintentional contact with the utensil, the handle of the utensil should be positioned so that it is turned inward, and does not extend over adjacent surface elements.
- **Do Not Immerse or Soak Removable Heating Elements.** Heating elements should never be immersed in water. Heating elements clean themselves during normal operation.
- **Never Leave Surface Elements Unattended at High Settings**—Boilovers cause smoking and greasy spillovers that may ignite, or a pan that has boiled dry may melt.
- **Make sure Drip Pans or Drip Bowls Are in Place**—Absence of these pans or bowls during cooking may subject wiring or components underneath to damage.
- **Protective Liners**—Do not use aluminum foil to line surface unit reflector pans, drip bowls, oven bottom or any other part of the range. Only use aluminum foil as recommended for baking if used as a cover placed on the food. Any other use of protective liners or aluminum foil may result in a risk of electric shock or fire.
- **Glazed Cooking Utensils**—Only certain types of glass, glass/ceramic, ceramic, earthenware, or other glazed utensils are suitable for rangetop service without breaking due to the sudden change in temperature. Check the manufacturer's recommendations for rangetop use.
- **Do Not Use Decorative Surface Element Covers.** If an element is accidentally turned on, the decorative cover will become hot and possibly melt. You will not be able to see that the element is on. Burns will occur if the hot covers are touched. Damage may also be done to the cooktop.

## IMPORTANT INSTRUCTIONS FOR USING YOUR OVEN

- **Use Care When Opening Door**—Stand to the side of the range when opening the door of a hot oven. Let hot air or steam escape before you remove or replace food in the oven.
- **Keep Oven Vent Ducts Unobstructed.** The oven is vented through the left rear surface element. Touching the surfaces in this area when the oven is operating may cause severe burns. Also, do not place plastic or heat-sensitive items on or near the oven vent. These items could melt or ignite.
- **Placement of Oven Racks.** Always place oven racks in the desired location while oven is cool. If a rack must be moved while the oven is hot, use extreme caution. Use potholders and grasp the rack with both hands to reposition. Do not let potholders contact the hot oven element or interior of the oven. Remove all utensils from the rack before removing rack.
- **Do not use the broiler pan without its insert.** The broiler pan and grid allow dripping fat to drain and be kept away from the high heat of the broiler.
- **Do not cover the broiler grid with aluminum foil.** Exposed fat and grease could ignite.
- **Do not touch a hot light bulb (some models) with a damp cloth.** Doing so could cause the bulb to break. Disconnect the range or turn off the power to the range before removing and replacing light bulb.

## IMPORTANT INSTRUCTIONS FOR CLEANING YOUR RANGE

- **Clean the range regularly to keep all parts free of grease that could catch fire.** Pay particular attention to the area underneath each surface element. Exhaust fan ventilation hoods and grease filters should be kept clean. Do not allow grease to accumulate. Greasy deposits in the fan could catch fire. Refer to the hood manufacturer's instructions for cleaning.
- **Kitchen cleaners/aerosols**—Always follow the manufacturer's recommended directions for use. Be aware that excess residue from cleaners and aerosols may ignite causing damage and/or injury.

### SELF-CLEANING OVENS:

- **Clean in the self-cleaning cycle only the parts of the oven listed in this owner's guide.** Before self-cleaning the oven, remove the broiler pan and any utensils stored in the oven.
- **Do not clean the oven door gasket.** The door gasket is essential for a good seal. Care should be taken not to rub, damage or move the gasket.
- **Do not use oven cleaners.** No oven cleaner or oven liner protective coating of any kind should be used in or around any part of the oven.

## SAVE THESE INSTRUCTIONS

# Control Pad Functions

## READ THE INSTRUCTIONS CAREFULLY BEFORE USING THE OVEN.

For satisfactory use of your oven, become familiar with the various functions of the oven as described below. Your model will have one of the 2 controls shown. Refer to Figure 1 or Figure 2, depending on your model.

### The oven can be programmed to:

- Bake normally
- Time bake
- Vari Broil
- Self-clean

**Figure 1**

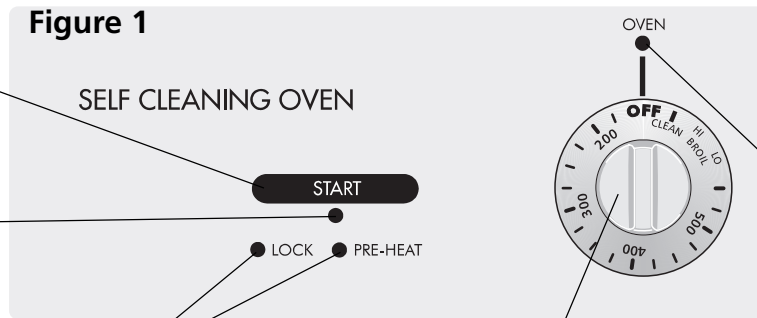

**START PAD**—Push to activate oven after oven functions are set.

**START INDICATOR LIGHT**—Flashes as a reminder to push the **START pad** to activate the oven.

**PRE-HEAT & LOCK LIGHTS**—The "**PRE-HEAT**" light will glow when the oven is first set to operate, or if the desired temperature is reset higher than the actual oven temperature. The "**LOCK**" light will flash until the door locks (or unlocks fully) when the self-clean cycle is in use. It glows constantly after the door locks.

**TEMPERATURE CONTROL KNOB**— Operates the Variable Broil, Bake or Self-Clean Cycle modes when used with the **START pad**. Cancels all oven functions when the Temperature Control knob is turned to **OFF**.

**OVEN INDICATOR LIGHT**—Glow each time the oven burner (element) turns on to maintain the set oven temperature.

**PRE-HEAT & LOCK LIGHTS**—The "**PRE-HEAT**" light will glow when the oven is first set to operate, or if the desired temperature is reset higher than the actual oven temperature. The "**LOCK**" light will flash until the door locks (or unlocks fully) when the self-clean cycle is in use. It glows constantly after the door locks.

**CLOCK PAD**— Used to set the time of day clock.

**BAKE TIME PAD**— Used to enter the length of the baking time.

**FEATURE INDICATOR LIGHTS**— These light to show which feature is in use.

**STOP TIME PAD**— Used to set the desired stop time for baking. Can be used with **BAKE TIME** to program a delayed bake cycle.

**TIMER ON/OFF PAD**— Used to set the minute timer. The minute timer does not start or stop cooking.

**Figure 2**

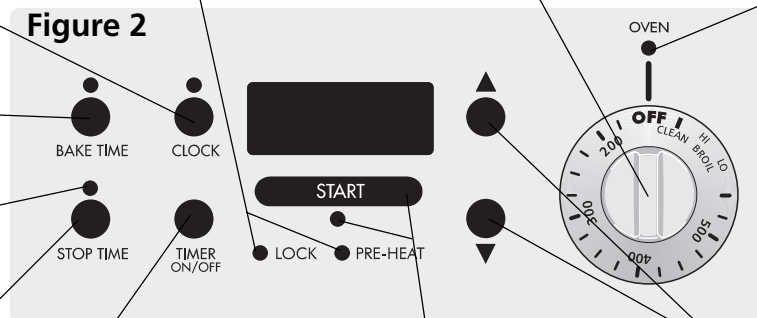

**TEMPERATURE CONTROL KNOB**— Operates the Variable Broil, Bake or Self-Clean Cycle modes when used with the **START pad**. Cancels all oven functions when the Temperature Control knob is turned to **OFF**.

**OVEN INDICATOR LIGHT**—Glow each time the oven burner (element) turns on to maintain the set oven temperature.

**START PAD**—Push to activate oven after oven functions are set.

**START INDICATOR LIGHT**—Flashes as a reminder to push the **START pad** to activate the oven.

**UP and DOWN ARROW PADS**— Used along with the function pads to select cooking time, stop time (when programming an automatic stop time), time of day and minute timer, and self-clean function.

# Setting the Clock and Minute Timer

## For a silent control panel (Figure 2 Only):

When choosing a function, a beep will be heard each time a pad is pushed. If desired, the controls can be programmed for silent operation. Push and hold **STOP TIME**. After 7 seconds, the control will beep once. This will block the controls from sounding when a pad is pushed. To return the sound, push and hold **STOP TIME** again for 7 seconds until 1 beep is heard. **Note:** The control will return to the audible mode after a power outage.

Figure 2 Only

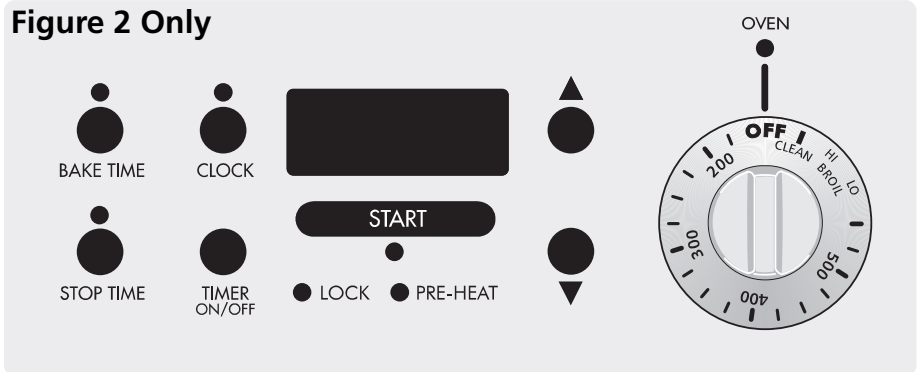

## To Set the Clock (Figure 2 Only)

When the range is first plugged in, or when the power supply to the range has been interrupted, the display will flash "12:00".

1. Push **CLOCK**.
2. Within 5 seconds, push and hold the **UP or DOWN ARROW** until the correct time of day appears in the display.

**Note:** The clock cannot be changed during any timed bake or self-clean cycle.

## To Set the Minute Timer

1. Push **TIMER ON/OFF**.
2. Push the **UP ARROW** to increase the time in one minute increments. Push and hold the **UP ARROW** to increase the time in 10 minute increments. The timer can be set for any amount of time from 1 minute to 11 hours and 59 minutes.

**Note:** If you push the **DOWN ARROW** first, the timer will advance to 11 hours and 59 minutes.

3. The display shows the timer count down in minutes until one minute remains. Then the display will count down in seconds.
4. When the set time has run out, the timer will beep 3 times. It will then continue to beep 3 times every 60 seconds until **TIMER ON/OFF** is pushed.

**Note:** The minute timer does not start or stop cooking. It serves as an extra timer in the kitchen that will beep when the set time has run out. The minute timer can be used alone or during any of the other oven functions. When the minute timer is in use with any other mode, the minute timer will be shown in the display. To view other functions, push the function pad for that mode.

## To Change the Minute Timer while it is in use:

While the timer is active and shows in the display, push and hold the **UP or DOWN ARROW** to increase or decrease the time.

## To Cancel the Minute Timer before the set time has run out:

Push **TIMER ON/OFF**.

## Setting Surface Controls

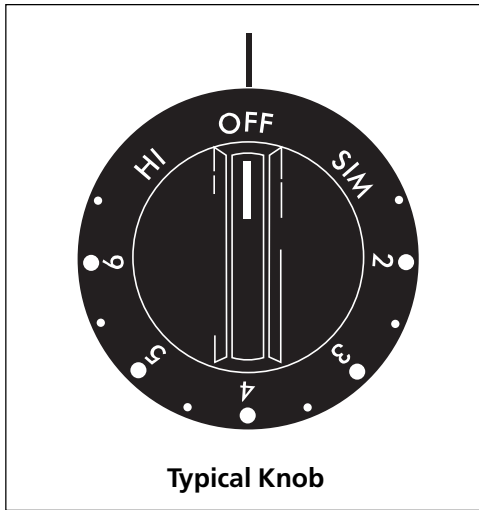

### To Operate the Surface Element

1. Place cooking utensil on the surface element.
2. Push in and turn the Surface Control knob in either direction to the desired setting. Start most cooking operations on a higher setting and then turn to a lower setting to finish cooking. The control knobs do not have to be set exactly on a particular mark. Use the marks as a guide and adjust the control knob as needed.
3. When cooking is completed, turn the surface element off before removing the pan. **Note:** The surface signal light will glow when one or more elements are turned on. A quick glance at the signal light(s) when cooking is finished is an easy check to be sure all control knobs are turned off.

The suggested settings found in the chart below are based on cooking in medium-weight aluminum pans with lids. Settings may vary when using other types of pans.

Setting	Type of Cooking
HIGH (HI)	Start most foods, bring water to a boil, pan broiling
MEDIUM HIGH (6)	Continue a rapid boil, fry, deep fat fry
MEDIUM (4-5)	Maintain a slow boil, thicken sauces and gravies, steam vegetables
MEDIUM LOW (2-3)	Keep foods cooking, poach, stew
SIMMER (SIM)	Keep warm, melt, simmer

**Note:** The size and type of utensil used, and the amount and type of food being cooked will influence the setting needed for best cooking results.

**CAUTION** Do not place plastic items such as salt and pepper shakers, spoon holders or plastic wrappings on top of the range when it is in use. These items could melt or ignite. Potholders, towels or wooden spoons could catch fire if placed too close to the element.

## Before Setting Oven Controls

### Oven Vent Location

The oven is vented under the **left rear surface element**. When the oven is on, warm air is released through the vents. This venting is necessary for proper air circulation in the oven and good baking results.

### Arranging Oven Racks

(Some models may have one rack.) *ALWAYS ARRANGE OVEN RACKS WHEN THE OVEN IS COOL (PRIOR TO OPERATING THE OVEN)*. Always use oven mitts when using the oven.

#### REMOVING & REPLACING OVEN RACKS

**To remove**, pull the rack forward until it stops. Lift up front of rack and slide out. **To replace**, fit the rack onto the guides on the oven walls. Tilt the front of the rack upward and slide the rack back into place.

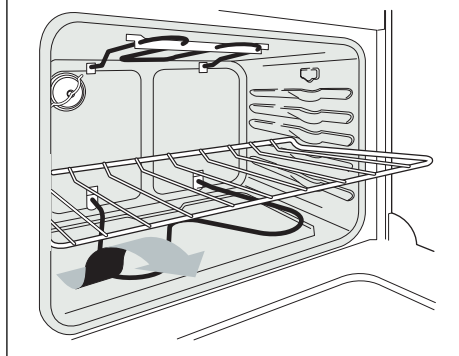

#### ARRANGING OVEN RACKS WITH 5 RACK POSITIONS

**To bake on one rack**, place the rack on position 3 or 4. **To bake on two racks (some models)**, place the racks on positions 2 and 4.

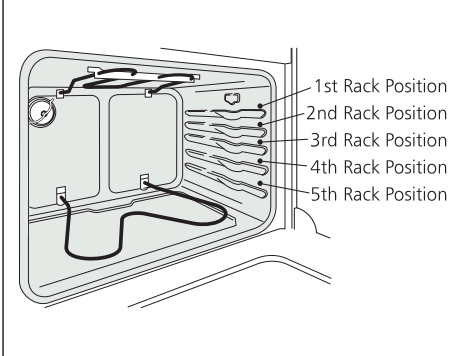



# Setting Oven Controls

Figure 1

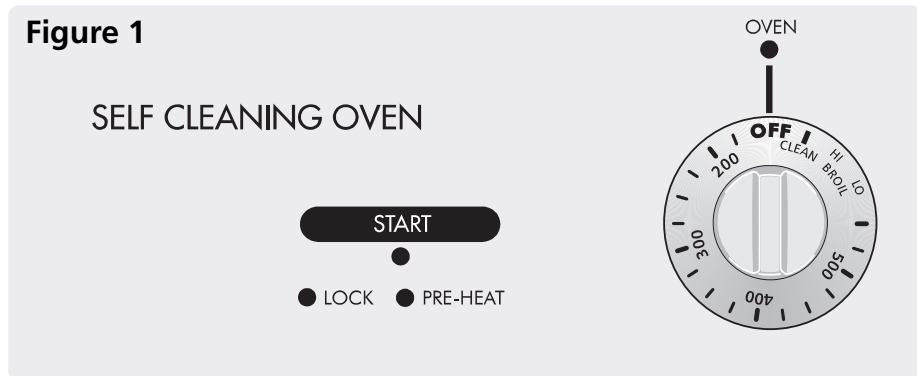
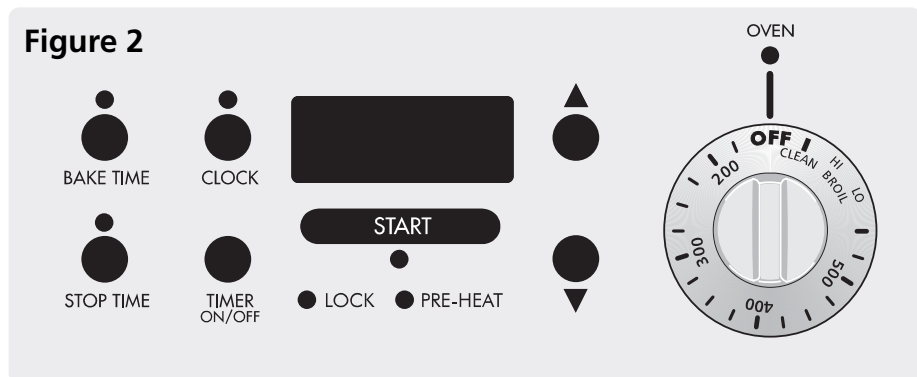

Figure 2



## To Set or Change the Temperature for Normal Baking

The oven can be programmed to bake at any temperature from 170°F to 550°F.

### To Set the Controls for Normal Baking:

1. Turn Temperature Control Knob to the desired baking temperature.
2. Push **START**. If **START** is not pushed, the control will beep as a reminder.
3. The oven will begin heating to the selected temperature. When the temperature reaches the desired baking temperature, the control will beep 3 times.
4. To cancel the baking function, turn Temperature Control Knob to **OFF**.

### To Change the Oven Temperature after Baking has Started:

Turn Temperature Control Knob to the new, desired temperature.

### If the Power is Interrupted During a Bake Cycle:

**Figure 1**—Press **START** to resume cooking.

**Figure 2**—Set clock to time of day, then press **START**.

## Setting Oven Controls

(continued)

Figure 2 Only

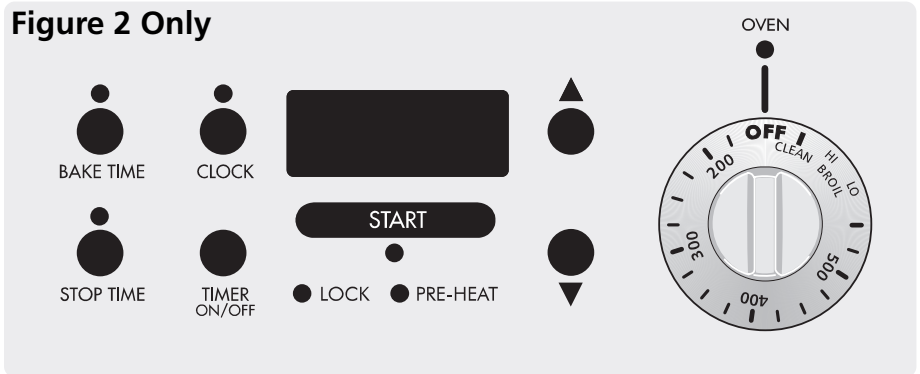

**CAUTION** Use caution when using the automatic timer. Use the automatic timer when cooking cured or frozen meats and most fruits and vegetables. Foods that can easily spoil such as milk, eggs, fish, meat or poultry, should be chilled in the refrigerator first. Even when chilled, they should not stand in the oven for more than 1 hour before cooking begins, and should be removed promptly when cooking is completed.

### To Set the Automatic Timer (Timed Bake Feature, Figure 2 Only)

The **BAKE TIME** and **STOP TIME** controls operate the Timed Bake feature. The automatic timer will turn the oven on and off at the times you select in advance. The oven can be programmed to start immediately and shut off automatically or to begin baking at a later time with an automatic shutoff.

### To Begin Baking Immediately with an Automatic Shut-Off:

1. Be sure that the clock shows the correct time of day.
2. Place the food in the oven.
3. Turn Temperature Control Knob to the desired baking temperature.
4. Push **BAKE TIME**. "0:00" will flash in the display.
5. Push the **UP or DOWN ARROW** until the desired baking time appears in the display.
6. Push **START**. If **START** is not pushed, the control will beep as a reminder.

### Once the Controls are Set:

- a. The oven will come on and begin heating to the selected baking temperature.
- b. The current time of day will show in the display. To view remains of Bake Time, push **BAKE TIME**.

### When the Set Bake Time Runs Out:

- a. "END" will appear in the display window and the oven will shut off automatically.
- b. The control will beep 3 times every 60 seconds until the Temperature Control Knob is turned to **OFF**.

### For a Delayed Start Time and Automatic Shut-Off:

Follow steps 1-5 above, THEN:

6. Push **STOP TIME**. The earliest possible stop time will flash in the display.
7. Push the **UP or DOWN ARROW** until the desired stop time appears in the display.
8. Push **START**.
9. Once the controls are set, the control calculates the time when baking will start in order to finish at the time you have set.

### When the Set Bake Time Runs Out:

- a. "END" will appear in the display window and the oven will shut off automatically.
- b. The control will beep 3 times every 60 seconds until the Temperature Control Knob is turned to **OFF**.

### To Change the Oven Temperature or Bake Time after Baking has Started:

Turn Temperature Control Knob to the new, desired temperature.

### To Change the Bake Time or Stop Time after Baking has Started:

Push **BAKE TIME** or **STOP TIME**. Then, push the **UP or DOWN ARROWS**.

# Setting Oven Controls

(continued)

Figure 1

## SELF CLEANING OVEN

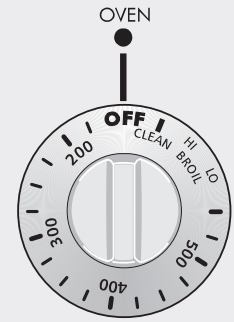
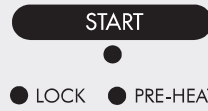
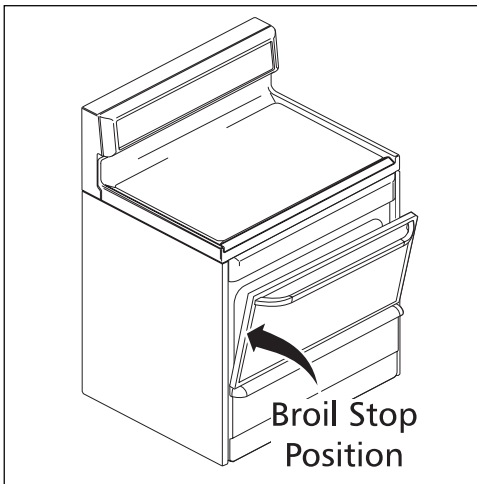
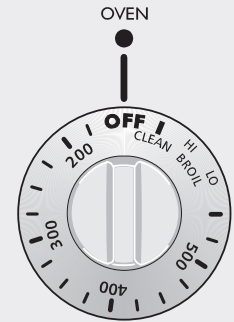
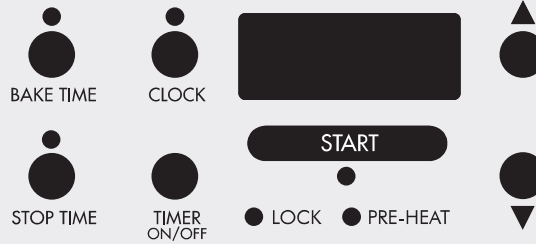

Figure 2



### To Broil

1. Arrange oven rack while oven is still cool. Position the rack as suggested in the chart below.

Rack Position From Top	Food
1	Rare steaks
2	Ham slices, fish, medium steaks, hamburgers and chops
3	Well-done foods such as chicken and lobster

2. Turn Temperature Control Knob to High Broil (HI) or Low Broil (LO).
3. Push **START**.
4. Place the grid on the broiler pan, then place the food on the grid. **DO NOT** use the broiler pan without the grid or cover the grid with aluminum foil. The exposed fat could ignite.
5. Place the pan on the oven rack. **Close the oven door to the broil stop position when broiling.**
6. Broil on one side until food is browned; turn and cook on the second side. Season and serve. **Note:** Always pull the rack out to the stop position before turning or removing food.
7. When broiling is finished, turn Temperature Control Knob to **OFF**.

**CAUTION** Should an oven fire occur, close the oven door and turn off the oven. If the fire continues, use a fire extinguisher. **DO NOT** put water or flour on the fire. Flour may be explosive.

The broiler pan and its grid allow dripping grease to drain and be kept away from the high heat of the broiler. **DO NOT** use the pan without its grid. **DO NOT** cover the grid with foil. The exposed grease could ignite.

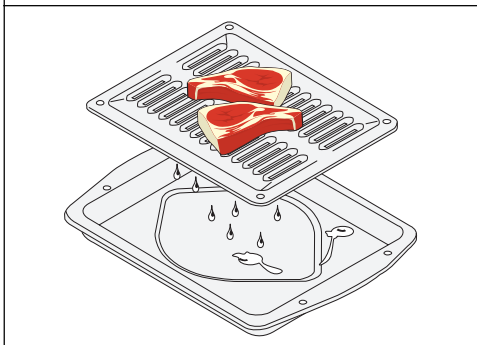

# Oven Cleaning

Figure 1

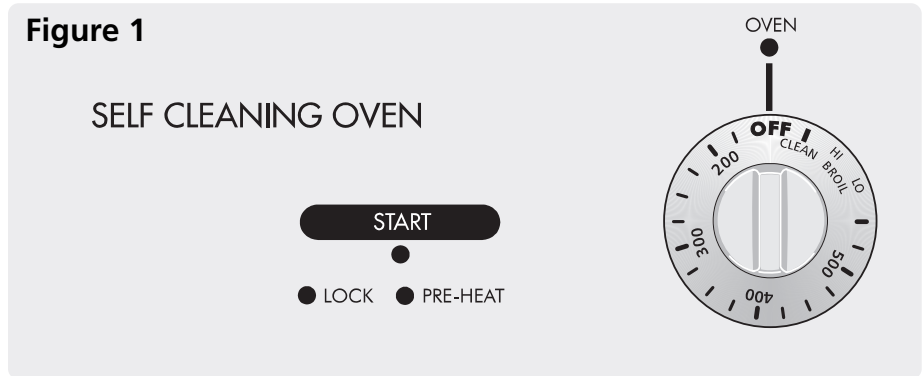
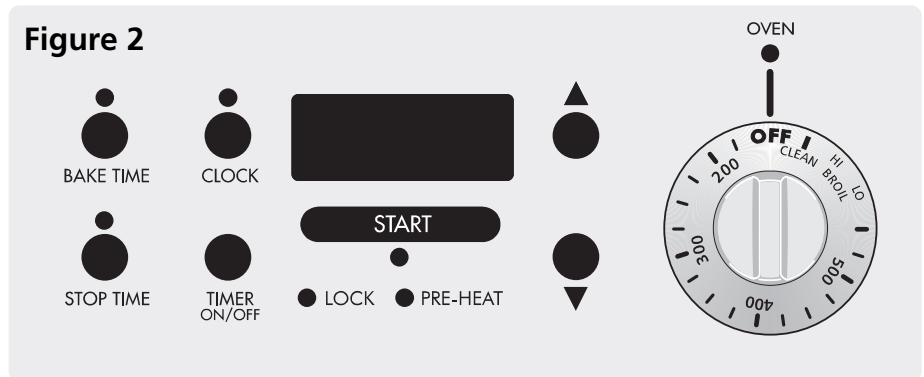

Figure 2



**CAUTION** During the self-cleaning cycle, the outside of the range can become very hot to the touch. **DO NOT** leave small children unattended near the appliance.

**CAUTION** **DO NOT** line the oven walls, racks, bottom or any other part of the range with aluminum foil. Doing so will destroy heat distribution, produce poor baking results and cause permanent damage to the oven interior (aluminum foil will melt to the interior surface of the oven).



**CAUTION** **DO NOT** force the oven door open. This can damage the automatic door locking system. Use caution when opening the door after the self-cleaning cycle is completed. The oven may still be VERY HOT.

## Self-Cleaning Oven

A self-cleaning oven cleans itself with high temperatures (well above cooking temperatures) which eliminate soil completely or reduce it to a fine powdered ash you can wipe away with a damp cloth.

### 1. Adhere to the following cleaning precautions:

- Allow the oven to cool before precleaning.
- Wear rubber gloves when precleaning and while wiping up the residue after the self-clean cycle.
- **DO NOT** use oven cleaners or oven protective coatings in or around any part of the self-cleaning oven.
- **DO NOT** clean the oven door gasket. The woven material of the oven door gasket is essential for a good seal. Care should be taken not to rub, damage or remove the gasket.
- **DO NOT** use any cleaning materials on the oven door gasket. Doing so could cause damage.

### 2. Remove the broiler pan and insert, all utensils and any aluminum foil. These items cannot withstand high cleaning temperatures.

3. Oven racks may be left in the oven or may be removed. If they go through the clean cycle their color will turn slightly blue and the finish will be dull. After the cycle is complete and the oven has cooled, rub the sides of the racks with wax paper or a cloth containing a small amount of baby oil or salad oil (this will make the racks glide easier into the rack position).

4. Remove any excess spillovers in the oven cavity before starting the self-cleaning cycle. To clean, use hot, soapy water and a cloth. Large spillovers can cause heavy smoke or fire when subjected to high temperatures. **DO NOT** allow food spills with a high sugar or acid content (such as milk, tomatoes, sauerkraut, fruit juices or pie filling) to remain on the surface as they may cause a dull spot even after cleaning.

5. Clean any soil from the oven frame, the door liner outside the oven door gasket and the small area at the front center of the oven bottom. These areas heat sufficiently to burn soil on. Clean with soap and water.

# Oven Cleaning

(continued)

Figure 1

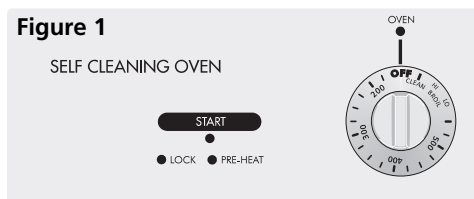

## To Start the Self-Clean Cycle (Figure 1)

The oven is programmed to run a 3 hour self-clean cycle.

1. Be sure the oven door is closed.
2. Turn Temperature Control Knob to **CLEAN**.
3. Push **START**.
4. If the door is left open, the "Lock" indicator light will flash, but the lock motor and clean cycle will not start. As soon as the controls are set and the door is closed, the motor driven lock will begin to close automatically and the "Lock" indicator light will flash. **DO NOT** open the door while the light is flashing (it takes about 15 seconds for the lock to close).

## When the Self-Clean Cycle is Completed (Figure 1)

1. The "Lock" indicator light will continue to glow.
2. Once the oven has cooled down for about 1 HOUR and the "Lock" indicator light has gone completely out (and is not flashing), the oven door can be opened.

Figure 2

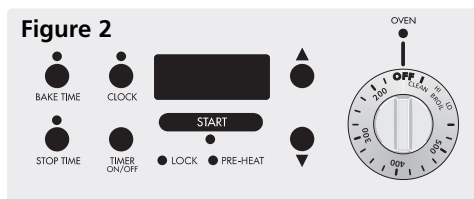

## To Start the Self-Clean Cycle (Figure 2)

The oven can be programmed to run a 2 or 3 hour self-clean cycle. We recommend a 2 hour self-clean cycle for **light soils** and a 3 hour cycle for **average to heavy soils** (to assure satisfactory results).

### To Set the Controls:

1. Be sure the oven door is closed.
2. Turn Temperature Control Knob to **CLEAN**.
3. Push **START**. "3:00" will appear in the display. (The oven will automatically program a 3 hour clean cycle.)
4. If you want a 2 hour clean cycle, press the **DOWN ARROW**. "2:00" will appear in the display.
5. If the door is left open, the "Lock" indicator light will flash and "dr" will glow in the display, but the lock motor and clean cycle will not start. As soon as the controls are set and the door is closed, the motor driven lock will begin to close automatically and the "Lock" indicator light will flash. "CLn" will appear and remain in the display until the cleaning cycle is completed or cancelled. **DO NOT** open the door while the light is flashing (it takes about 15 seconds for the lock to close).
6. Press **START** at any time during the self-clean cycle to review remaining cleaning time.

**Note:** If the oven is set to bake or broil, and then the Temperature Control Knob is set to **CLEAN**, it will not start the clean cycle until **START** is pressed again.

**CAUTION** Use care when opening the oven door after the self-cleaning cycle. Stand to the side of the oven when opening the door to allow hot air or steam to escape.

**CAUTION DO NOT** force the oven door open. This can damage the automatic door locking system. Use caution when opening the door after the self-cleaning cycle is completed. The oven may still be **VERY HOT**.

## When the Self-Clean Cycle is Completed (Figure 2)

1. The time of day will appear in the display window and the "Lock" indicator light will continue to glow.
2. Once the oven has cooled down for about 1 HOUR and the "Lock" indicator light has gone completely out (and is not flashing), the oven door can be opened.

## Stopping or Interrupting a Self-Cleaning Cycle (Figure 1 or 2)

If it becomes necessary to stop or interrupt a self-cleaning cycle:

1. Turn Temperature Control Knob to **OFF**.
2. Once the oven has cooled down for about 1 HOUR and the "Lock" indicator light has gone completely out (and is not flashing), the oven door can be opened.

# General Cleaning

## Cleaning Various Parts of Your Range

Before cleaning any part of the range, be sure all controls are turned OFF and the range is COOL. Remove spillovers and heavy soiling as soon as possible. REGULAR CLEANINGS WILL REDUCE THE NUMBER OF MAJOR CLEANINGS LATER.

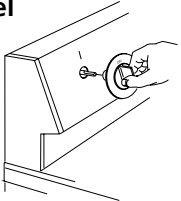
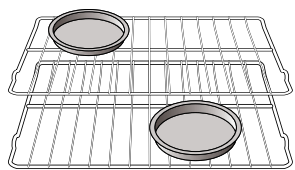
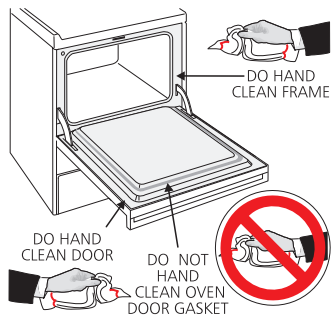
Surfaces	How to Clean
<b>Aluminum</b> (Trim Pieces) & <b>Vinyl</b>	Use hot, soapy water and a cloth. Dry with a clean cloth.
<b>Glass, Paint and Plastic</b> Control Knobs, Body Parts and Decorative Trim	<i>For general cleaning</i> , use hot, soapy water and a cloth. <i>For more difficult soils and built-up grease</i> , apply a liquid detergent directly onto the soil. Leave on soil for 30 to 60 minutes. Rinse with a damp cloth and dry. <b>DO NOT</b> use abrasive cleaners on any of these materials; they can scratch. To remove control knobs, turn to the OFF position; grasp firmly and pull straight off the shaft. To replace knobs after cleaning, line up the flat sides of both the knob and the shaft; then push the knob into place.
<b>Control Panel</b> 	<i>Before cleaning the control panel</i> , turn all controls to OFF and remove the control knobs. To remove, pull each knob straight off the shaft. Clean using hot, soapy water and a dishcloth. Be sure to squeeze excess water from the cloth before wiping the panel; especially when wiping around the controls. Excess water in or around the controls may cause damage to the appliance. To replace knobs after cleaning, line up the flat sides of both the knob and the shaft; then push the knob into place.
<b>Porcelain Enamel</b> Cooktop, Under Cooktop, Broiler Pan and Insert, Door Liner	Gentle scouring with a soapy scouring pad will remove most spots. Rinse with a 1:1 solution of clear water and ammonia. <i>If necessary</i> , cover difficult spots with an ammonia-soaked paper towel for 30 to 40 minutes. Rinse with clean water and a damp cloth, and then scrub with a soap-filled scouring pad. Rinse and wipe dry with a clean cloth. Remove all cleaners or the porcelain may become damaged during future heating. <b>DO NOT</b> use spray oven cleaners on the cooktop.
<b>Stainless Steel, Chrome</b> Decorative Trim	Clean with hot, soapy water and a dishcloth. Rinse with clean water and a dishcloth. Cover stubborn spots with an ammonia-soaked paper towel for 30 to 40 minutes. Rinse. Cleaners made especially for stainless steel are recommended. Be sure to rinse the cleaners as bluish stains may occur during heating and cannot be removed.
<b>Oven Racks</b> 	<p>Oven racks may be removed or left in the oven during the self-clean cycle for cleaning. If removed, clean by using a mild, abrasive cleaner following manufacturer's instructions. Rinse with clean water and dry.</p> <p>If the racks are cleaned in the self-clean cycle, their color will turn slightly blue and the finish will be dull. After the self-clean cycle is complete, and the oven has cooled, rub the sides of the racks with wax paper or a cloth containing a small amount of baby oil or salad oil (this will make the racks glide easier into the rack positions).</p>
<b>Oven Door</b> 	<p>To clean oven door, wash with hot, soapy water and a clean cloth. <b>DO NOT</b> immerse the door in water.</p> <p><b>DO NOT</b> clean the oven door gasket. The oven door gasket is made of a woven material which is essential for a good seal. Care should be taken not to rub, damage or remove the gasket.</p>

# General Cleaning

(continued)

**CAUTION** Be sure the range is cool before removing elements or drip bowls.

Be careful not to bend terminal ends when replacing elements after cleaning.

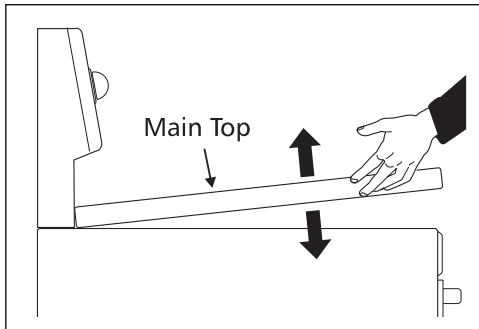
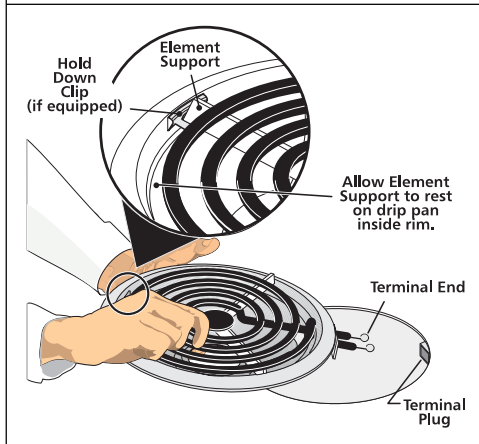

**CAUTION** When lowering the lift-up range top, grasp the sides with fingertips only. Be careful not to pinch fingers. **DO NOT** drop or bend the range top when raising or lowering. This could damage the surface.

**CAUTION** The door is heavy. For safe, temporary storage, lay the door flat with the inside of the door facing down.

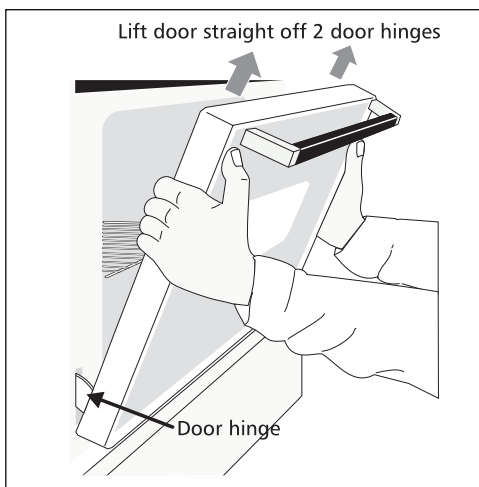

## Surface Elements and Drip Bowls

Surface elements can be unplugged and removed to make cleaning the drip pans easier. The surface elements clean themselves when they are turned on. Food spilled on a hot element will burn off. Food spilled on a cool element may be cleaned with a damp cloth—any remaining soil will burn off the next time the element is used. **Never immerse a surface element in water.**

### To Remove the Surface Elements and Drip Bowls

1. Lift the edge of the drip bowl across from the terminal end. **Lift the surface element and drip bowl together** just enough to clear the cooktop.
2. While holding the drip bowl and surface element, gently pull the terminal end out from the terminal plug. If equipped, **DO NOT** remove the hold down clip from the drip bowl.

### To Clean Drip Bowls

Wash in hot, soapy water or in the dishwasher. Rinse and dry while still warm. Hard to remove, burned on soil can be removed by soaking the drip bowls for about 20 minutes in a lightly diluted liquid cleanser or a solution of ammonia and water (1/2 cup ammonia to 1 gallon of water). A nylon scrubber may be used after soaking. **DO NOT** use abrasive cleaners or steel wool, as they will scratch the surface. Always rinse with clean water and polish dry with a soft cloth.

### To Replace Drip Bowls and Surface Elements

1. Slide the terminal end on the element through the opening in the drip bowl.
2. Align the element support to rest on the rim inside the drip bowl. If your drip bowl is equipped with a hold down clip, align the element support opposite the terminal end with the slot in the hold down clip, and snap into place.
3. After the element is positioned in the drip bowl, line up the terminal end with the terminal plug as shown.
4. Hold the surface element and drip bowl together as level as possible and firmly push the terminal end into the terminal plug. Make sure element terminal is seated properly into terminal plug. Make sure the surface element is level to reduce the hazard of pans sliding off the element.

### To Raise the Top for Cleaning

1. Grasp the sides and lift from the front. Lift-up rods will support the top in its raised position. Only lift the top high enough to allow the support rods to snap into place.
2. Clean underneath using a clean cloth and hot, soapy water.
3. To lower the top, gently push back on each rod to release the notched support. Hold the range top and slide the range top down into the range frame.

### To Remove and Replace Oven Door

#### To Remove Oven Door

1. Open the door to the quarter-open position. Grasp the door firmly on both sides and lift up and off the hinges.
2. To clean oven door, follow the instructions provided in the cleaning chart under **General Cleaning**.

#### To Replace Oven Door

1. Be sure the hinge arms are in the quarter-open position. Be careful if pulling the hinges open by hand. The hinges may snap back against the oven frame and could pinch fingers.
2. Hold the door at the sides near the top. Insert the hinge arms into slots at the bottom of the door.
3. Hinge arms must go into the range slots evenly. The hinge arms should be inserted into the bottom corners of the door as far as they can go.
4. If the door is not in line with the oven frame, remove it and repeat the above steps.

## Changing Cooktop and/or Oven Lights (some models)

**⚠ CAUTION** Be sure the range is unplugged and all parts are COOL before replacing the surface or oven lights. Wear a leather-faced glove for protection against possible broken glass.

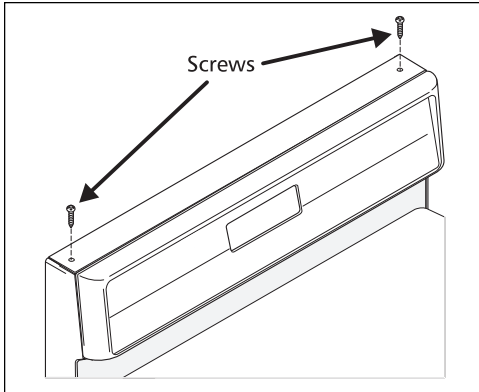

### To Change the Cooktop Light (some models)

For models with 2 Phillips® Head screws that secure the light cover, follow these instructions:

1. Turn power off at the main source or unplug the range.
2. Remove Phillips® Head screws (2) that secure the light cover and then lift the light cover off.
3. Remove bulb by rolling back and up. Install the new bulb by sliding down and rolling forward into place.
4. Re-install light cover and secure with Phillips® Head screws (2).

### To Change the Oven Light (some models)

On some models, the oven light automatically turns on when the door is opened. Some models have a switch located on the control panel to turn on the light. The oven light is located at the rear of the oven and is covered with a glass shield held by a wire holder. The glass shield must be in place whenever the oven is in use.

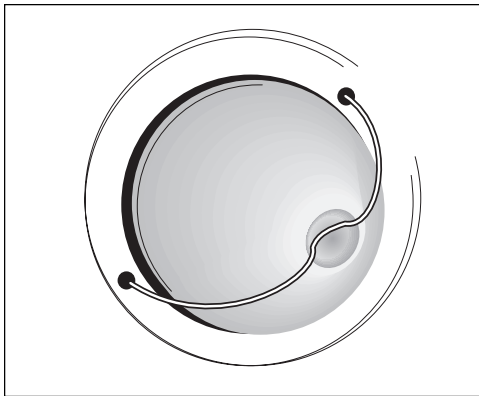

### To replace the oven light:

1. Turn electrical power off at the main source or unplug the range.
2. Press wire holder to one side to release the glass shield.
3. Replace bulb with a new 40 watt appliance bulb.
4. Replace glass shield over bulb and snap wire holder into place.
5. Turn power back on again at the main source (or plug the range back in).
6. The clock(if equipped) will then need to be reset. To reset, see **Setting the Clock and Minute Timer** in this Owner's Guide.



# Adjusting Oven Temperature

Figure 1

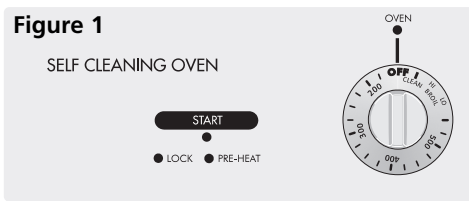

The temperature in the oven has been set at the factory. When first using the oven, be sure to follow recipe times and temperatures. If you think the oven is too hot or too cool, the temperature in the oven can be adjusted. Before adjusting, test a recipe by using a temperature setting that is higher or lower than the recommended temperature. The baking results should help you to decide how much of an adjustment is needed.

## To Adjust Oven Temperature (Figure 1)

1. With the dial set to **OFF**, press and hold **START** for 30 seconds until a single beep is heard.
2. Within 5 seconds, turn the Temperature Control Knob **clockwise** to either the High (HI) or Low (LO) Broil setting. Select High Broil (HI) to increase the temperature or Low Broil (LO) to decrease the temperature.
3. The temperature can be adjusted up or down 35°F, in 5°F steps, by pressing **START**. Adjust until the desired amount of offset is indicated by the indicator lights as follows:

A flashing "OVEN" indicator light indicates a positive offset, while a flashing "LOCK" indicator light indicates a negative offset. The lights will flash once for each 5°F of offset. If no light is flashing, the oven control has the original factory calibration, and the offset is 0°F. *Example: If the OVEN indicator light is flashing three times and then pauses, the offset is +15°F.*

4. When you have made the desired adjustment, turn the Temperature Control Knob to **OFF**.

Figure 2

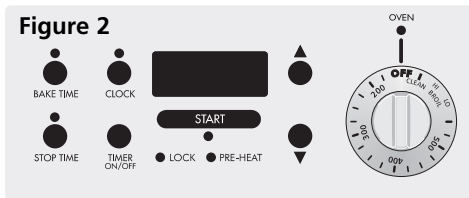

## To Adjust Oven Temperature (Figure 2)

1. With the dial set to **OFF**, press and hold **START** for 30 seconds until a single beep is heard.
2. Within 5 seconds, turn the Temperature Control Knob **clockwise** to either the High Broil (HI) or Low Broil (LO) setting.
3. The display now indicates the amount of degrees offset between the original factory temperature setting and the current temperature setting. If the oven control has the original factory calibration, the display will read "00."
4. The temperature can now be adjusted up or down 35°F, in 5°F steps, by pushing and holding the **UP** or **DOWN ARROW**. Adjust until the desired amount of offset appears in the display.
5. When you have made the desired adjustment, turn the Temperature Control Knob to **OFF**.

## Avoid Service Checklist

Before you call for service, review this list. It may save you time and expense. The list includes common occurrences that are not the result of defective workmanship or materials in this appliance.

This oven is equipped with a state of the art electronic oven controller. Among its many features is a full time oven circuit diagnostics system. The controller constantly monitors its internal circuitry as well as several crucial oven circuits to insure they are all operating correctly. If at any time one of these systems fails, the controller will immediately stop operation, and beep continuously (flashing an error code of F1 or F3\* in the display window, if equipped).

### OCCURRENCE

### POSSIBLE CAUSE/SOLUTION

---

#### Range is not level.

Poor installation. Place oven rack in center of oven. Place a level on the oven rack. Adjust leveling legs at base of range until the oven rack is level.

---

Be sure floor is level and is strong and stable enough to adequately support range.

---

If floor is sagging or sloping, contact a carpenter to correct the situation.

---

Kitchen cabinet alignment may make range appear unlevel. Be sure cabinets are square and have sufficient room for range clearance.

---

#### Cannot move appliance easily. Appliance must be accessible for service.

Cabinets not square or are built in too tightly. Contact builder or installer to make appliance accessible.

---

Carpet interferes with range. Provide sufficient space so range can be lifted over carpet.

---

#### \*Oven control beeps continuously with no indicator lights flashing. (If model is equipped with a display, F1 or F3 will show.)

Electronic control has detected a fault condition. Turn the Temperature Control Knob to **OFF**, and disconnect the power to the range. Wait 30 seconds and reconnect the power. If fault recurs, disconnect the power and contact an authorized servicer.

---

#### Surface element too hot or not hot enough.

Incorrect control setting. Make sure the correct control is on for the surface element to be used.

---

#### Surface element does not heat.

Lightweight or warped pans used. Use only flat, evenly balanced, medium or heavyweight cookware. Flat pans heat better than warped pans. Cookware materials and weight of the material affect heating. Heavy- and medium-weight pans heat evenly. Because lightweight pans heat unevenly, foods may burn easily.

---

No power to the appliance. Check steps under "Entire Appliance Does Not Operate" in this **Avoid Service Checklist**.

---

Incorrect control setting. Make sure the correct control is on for the surface element to be used.

---

Element not making contact in block. Follow instructions under "Surface Elements and Drip Bowls" in the **General Cleaning** section.

---

#### Entire appliance does not operate.

Make sure cord/plug is plugged tightly into outlet.

---

Service wiring is not complete. Contact your dealer, installing agent or authorized servicer.

---

Power outage. Check house lights to be sure. Call your local electric company for service.

<b>Cooktop and/or oven lights (some models) does not work.</b>	Replace or tighten bulb. See <b>Changing Cooktop and/or Oven Lights (some models)</b> in this Owner's Guide for instructions.
<b>Oven smokes excessively during broiling.</b>	<p>Control(s) not set properly. Follow instructions under <b>Setting Oven Controls</b>.</p> <p>Make sure oven door is opened to <b>broil stop position</b>.</p> <p>Meat too close to the element. Reposition the rack to provide proper clearance between the meat and the element. Preheat broil element for searing.</p> <p>Meat not properly prepared. Remove excess fat from meat. Cut remaining fatty edges to prevent curling, but do not cut into lean.</p> <p>Grid on broiler pan wrong side up and grease not draining. Always place grid on the broiler pan with ribs up and slots down to allow grease to drip into pan.</p> <p>Grease has built up on oven surfaces. Regular cleaning is necessary when broiling frequently. Old grease or food spatters cause excessive smoking.</p>
<b>Poor baking results.</b>	If baked food items are too dark on top or bottom, allow the oven to preheat to the set temperature before placing food in the oven. Make sure the proper rack position is used when baking food. Set temperature 25°F lower than recommended. If food is not done after recommended time, increase set temperature by 25°F.
<b>Self-cleaning cycle does not work.</b>	<p>Control(s) not set properly. Follow instructions under <b>Oven Cleaning</b>.</p> <p>Self-cleaning cycle was interrupted. Follow steps under "Stopping or Interrupting a Self-Cleaning Cycle" under <b>Oven Cleaning</b>.</p>
<b>Soil not completely removed after self-cleaning cycle.</b>	Failure to clean bottom, front top of oven, frame of oven or door area outside oven seal. These areas are not in the self-cleaning area, but get hot enough to burn on residue. Clean these areas before the self-cleaning cycle is started. Burned-on residue can be cleaned with a stiff nylon brush and water or a nylon scrubber. Be careful not to damage the oven gasket.
<b>Flames inside oven or smoking from vent.</b>	<p>Excessive spillovers in oven. Set self-clean cycle for a longer cleaning time.</p> <p>Excessive spillovers in oven. This is normal, especially for high oven temperatures, pie spillovers or large amounts of grease on bottom of oven. Wipe up excessive spillovers before starting cycle. If flames or excessive smoke are present, stop the self-clean cycle and follow steps under "Stopping or Interrupting a Self-Cleaning Cycle" in the <b>Oven Cleaning</b> section.</p>

# RANGE WARRANTY

Your product is protected by this warranty

Your appliance is warranted by White Consolidated Industries, Inc. WCI has authorized Frigidaire Company Consumer Services and their authorized servicers to perform services under this warranty. WCI authorizes no one else to change or add to any of these obligations under this warranty. Any obligations for service and parts under this warranty must be performed by Frigidaire Consumer Services or an authorized Frigidaire servicer.

	WARRANTY PERIOD	WE WILL, THROUGH OUR AUTHORIZED SERVICERS:	THE CONSUMER WILL BE RESPONSIBLE FOR:
<b>FULL ONE-YEAR WARRANTY</b>	One year from original purchase date.	Pay all costs for repairing or replacing any parts of this appliance which prove to be defective in materials or workmanship.	Costs of service calls that are listed under <b>NORMAL RESPONSIBILITIES OF THE CONSUMER.*</b>
<b>LIMITED WARRANTY (Applicable to the State of Alaska)</b>	Time period listed above.	All of the provisions of the full warranty above and the exclusions listed below apply.	Costs of the technician's travel to the home and any costs for pick up and delivery of the appliance required because of service.

## \*NORMAL RESPONSIBILITIES OF THE CONSUMER

**This warranty applies only to products in ordinary household use, and the consumer is responsible for the items listed below:**

1. Proper use of the appliance in accordance with instructions provided with the product.
2. Proper installation by an authorized servicer in accordance with instructions provided with the appliance and in accordance with all local plumbing, electrical and/or gas codes.
3. Proper connection to a grounded power supply of sufficient voltage, replacement of blown fuses, repair of loose connections or defects in house wiring.
4. Expenses for making the appliance accessible for servicing, such as removal of trim, cupboards, shelves, etc., which are not a part of the appliance when it was shipped from the factory.
5. Damages to finish after installation.
6. Replacement of light bulbs and/or fluorescent tubes (on models with these features).

## EXCLUSIONS

**This warranty does not cover the following:**

1. CONSEQUENTIAL OR INCIDENTAL DAMAGES SUCH AS PROPERTY DAMAGE AND INCIDENTAL EXPENSES RESULTING FROM ANY BREACH OF THIS WRITTEN OR ANY IMPLIED WARRANTY.  
*Note: Some states do not allow the exclusion or limitation of incidental or consequential damages, so this limitation or exclusion may not apply to you.*
2. Service calls which do not involve malfunction or defects in workmanship or material, or for appliances not in ordinary household use. The consumer shall pay for such service calls.
3. Damages caused by services performed by persons other than authorized Frigidaire Company servicers; use of parts other than Frigidaire Company Genuine Renewal Parts; obtained from persons other than such servicers; or external causes such as abuse, misuse, inadequate power supply or acts of God.
4. Products with original serial numbers that have been removed or altered and cannot be readily determined.

## IF YOU NEED SERVICE

Keep your bill of sale, delivery slip, or some other appropriate payment record. The date on the bill establishes the warranty period should service be required. If service is performed, it is in your best interest to obtain and keep all receipts. This written warranty gives you specific legal rights. You may also have other rights that vary from state to state. Service under this warranty must be obtained by following these steps, in order:

1. Contact Frigidaire Company Consumer Services or an authorized Frigidaire Company servicer.
2. If there is a question as to where to obtain service, contact the Frigidaire Consumer Relations Department at:

Frigidaire Consumer Relations  
P.O. Box 7181  
Dublin, Ohio 43017  
**(800) 944-9044**



Product features or specifications as described or illustrated are subject to change without notice. All warranties are made by White Consolidated Industries, Inc. This warranty applies only in the 50 states of the U.S.A. and Puerto Rico.

## Free Manuals Download Website

<http://myh66.com>

<http://usermanuals.us>

<http://www.somanuals.com>

<http://www.4manuals.cc>

<http://www.manual-lib.com>

<http://www.404manual.com>

<http://www.luxmanual.com>

<http://aubethermostatmanual.com>

Golf course search by state

<http://golfingnear.com>

Email search by domain

<http://emailbydomain.com>

Auto manuals search

<http://auto.somanuals.com>

TV manuals search

<http://tv.somanuals.com>