

# Power-Lock™ Heated Hose

309572ZAF  
EN

**For use with plural component proportioners. For professional use only.  
Not approved for use in European explosive atmospheres.**

*See page 3 for Maximum Fluid Working Pressure*

*130 psi (0.9 MPa, 9 bar) Maximum Air Working Pressure*

*180°F (82°C) Maximum Hose Operating Temperature*



## **Important Safety instructions.**

Read all warnings and instructions in this manual.  
Save these instructions. See page 3 for a list of  
part numbers.

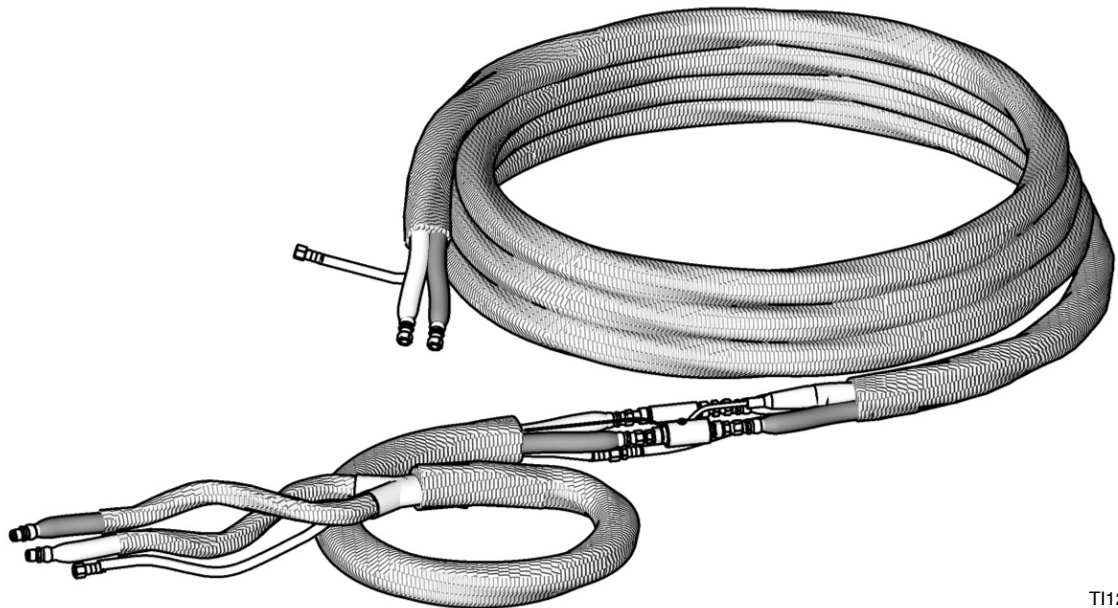

TI12157a

# Contents

|  |           |   |           |
|--|-----------|---|-----------|
| <b>Power-Lock Hose Bundle Part Numbers</b> . . . . .                                       | <b>3</b>  | <b>Operation</b> . . . . .  | <b>23</b> |
| Whip Hoses . . . . .   | 3         | Fluid Temperature Sensor (FTS) Calibration . . . . .  | 23        |
| Adapter Fittings . . . . .   | 3         | <b>Maintenance</b> . . . . .  | <b>24</b> |
| Standard 2 Component Hose . . . . .  | 4         | Instructions for Replacing Individual A or B Hose . . . . .                                   | 24        |
| RTD 2-Component Hose (for use with GCA<br>Controlled Reactors) . . . . .                   | 4         | <b>Parts</b> . . . . .  | <b>25</b> |
| Airless 2 Component Hose . . . . .   | 5         | Using 261669 Fluid Temperature Sensor (JIC to JIC<br>fittings) . . . . .                      | 25        |
| Custom Application 2 Component Hose . . . . .  | 5         | Using 24M943 Fluid Temperature Sensor (NPT to<br>NPT fittings) . . . . .                      | 26        |
| Fluid Temperature Sensor (FTS) Kits . . . . .  | 6         | Using 24K207 RTD 2-Component Hose Fluid<br>Temperature Sensor (JIC to JIC fittings) . . . . . | 27        |
| Fluid Temperature Sensor Kits (FTS, RTD;<br>for use with GCA Controlled Systems) . . . . . | 6         | Using 24M944 RTD 2-Component Hose Fluid<br>Temperature Sensor (NPT to NPT fittings) . . . . . | 28        |
| <b>Warnings</b> . . . . .  | <b>7</b>  | Using 261670 Fluid Temperature Sensor (JIC to<br>NPT fittings) . . . . .                      | 29        |
| <b>Important Two-Component Material Information</b> . . . . .                              | <b>9</b>  | 15F144 Hose Wire Jumper . . . . .   | 30        |
| Isocyanate Conditions . . . . .  | 9         | <b>Accessories</b> . . . . .  | <b>32</b> |
| Material Self-ignition . . . . .   | 9         | Scuff Guard . . . . .   | 32        |
| Keep Components A and B Separate . . . . .   | 9         | <b>Technical Data</b> . . . . .   | <b>33</b> |
| Moisture Sensitivity of Isocyanates . . . . .  | 10        | <b>Graco Standard Warranty</b> . . . . .  | <b>36</b> |
| Foam Resins with 245 fa Blowing Agents . . . . .   | 10        | <b>Graco Information</b> . . . . .  | <b>36</b> |
| Changing Materials . . . . .   | 10        |   |           |
| <b>Installation</b> . . . . .  | <b>11</b> |   |           |
| Description . . . . .  | 11        |   |           |
| Connect Whip Hose to Gun or Gun Manifold . . . . .   | 12        |   |           |
| Connect Heated Hoses . . . . .   | 13        |   |           |
| Connect FTS and Heated Dual Whip Hose . . . . .  | 18        |   |           |
| Connect FTS with a Non-Heated Whip Hose or<br>Remote Mix Manifold . . . . .                | 20        |   |           |
| Check Hoses for Leaks . . . . .  | 21        |   |           |
| Protective Covering . . . . .  | 22        |   |           |

# Power-Lock Hose Bundle Part Numbers

You need at least one 50 ft (15.2 m) main hose, one fluid temperature sensor (FTS), and one whip hose or one wire harness jumper (part no. 261821) to make a complete heated hose assembly. Be sure the selected hose meets your maximum pressure and hose diameter requirements.

## Whip Hoses

| Hose Assembly                       | Length ft (m) | ID in. (mm) | Heated | Standard Braided Scuff Guard | Xtreme-Wrap Scuff Guard | Hose Fittings             |                           |
|-------------------------------------|---------------|-------------|--------|------------------------------|-------------------------|---------------------------|---------------------------|
|                                     |               |             |        |                              |                         | "A" inlet (f)/ outlet (m) | "B" inlet (f)/ outlet (m) |
| <b>2000 psi (13.8 MPa, 138 bar)</b> |               |             |        |                              |                         |                           |                           |
| 246050                              | 10 (3)        | 1/4 (6)     | ✓      |                              | ✓                       | -5 JIC                    | -6 JIC                    |
| 249586                              | 3 (0.9)       | 1/4 (6)     | ✓      | ✓                            |                         | -5 JIC                    | -6 JIC                    |
| 256407                              | 6 (1.8)       | 1/4 (6)     | NA     | NA                           | NA                      | -5 JIC                    | -6 JIC                    |
| <b>3500 psi (24.1 MPa, 241 bar)</b> |               |             |        |                              |                         |                           |                           |
| 246055                              | 10 (3)        | 1/4 (6)     | ✓      |                              | ✓                       | -5 JIC                    | -6 JIC                    |
| 246056                              | 10 (3)        | 3/8 (10)    | ✓      | ✓                            |                         | -5 JIC                    | -6 JIC                    |
| 256626                              | 6 (1.8)       | 1/4 (6)     | NA     | NA                           | NA                      | -5 JIC                    | -6 JIC                    |
| 261686                              | 10 (3)        | 3/8 (10)    | ◆      | ✓                            |                         | -5 JIC                    | -6 JIC                    |
| <b>5000 psi (34.5 MPa, 345 bar)</b> |               |             |        |                              |                         |                           |                           |
| 258701                              | 10 (3)        | 1/4 (6)     | ✓      | ✓                            |                         | -5 JIC                    | -6 JIC                    |

◆ Individual heated A and B lines.

## Adapter Fittings

Use adapter fittings to connect a hose assembly to a fluid manifold and/or a FTS. Use JIC swivel fittings to connect a female FTS to male end hoses and/or npt female ball valves on mix manifold inlets.

| Part                                | Hose Fittings |                     |
|-------------------------------------|---------------|---------------------|
|                                     | End #1        | End #2              |
| <b>4500 psi (31 MPa, 310 bar)</b>   |               |                     |
| 117833                              | 3/8 npt (m)   | -8 JIC (m)          |
| <b>5000 psi (34.5 MPa, 345 bar)</b> |               |                     |
| 116702                              | 1/4 npt (m)   | -10 JIC (m)         |
| 116703                              | 1/4 npt (m)   | -8 JIC (m)          |
| 116704                              | 1/4 npt (m)   | -6 JIC (m)          |
| 116765                              | 3/8 npt (m)   | -10 JIC (m)         |
| 117506                              | 1/4 npt (m)   | -6 JIC (f), swivel  |
| 117832                              | 3/8 npt (m)   | -6 JIC (m)          |
| 119998                              | 1/4 npt (m)   | -5 JIC (m)          |
| 122406                              | 3/8 npt (m)   | -5 JIC (m)          |
| 126327                              | 3/8 npt (m)   | -6 JIC (f), swivel  |
| 126328                              | 3/8 npt (m)   | -8 JIC (f), swivel  |
| 126329                              | 1/2 npt (m)   | -8 JIC (f), swivel  |
| 126330                              | 1/2 npt (m)   | -10 JIC (f), swivel |
| 126339                              | 3/8 npt (m)   | -10 JIC (f), swivel |

| Part                              | Hose Fittings |                    |
|-----------------------------------|---------------|--------------------|
|                                   | End #1        | End #2             |
| <b>6000 psi (41 MPa, 414 bar)</b> |               |                    |
| 117595                            | 1/4 npt (m)   | -6 JIC (f), swivel |
| 126431                            | 1/2 npt (m)   | -6 JIC (f), swivel |
| 126432                            | 1/2 npt (m)   | -6 JIC (f), 45°    |
| <b>7250 psi (50 MPa, 500 bar)</b> |               |                    |
| 100206                            | 1/2 npt (m)   | 1/4 (f)            |
| 121433                            | 1/2 npt (m)   | 3/8 (f)            |
| 159841                            | 3/8 npt (m)   | 1/4 (f)            |
| <b>7400 psi (51 MPa, 510 bar)</b> |               |                    |
| 158491                            | 1/2 npt (m)   | 1/2 (m)            |
| 159239                            | 1/2 npt (m)   | 3/8 (m)            |
| 162449                            | 1/2 npt (m)   | 1/4 (m)            |
| <b>7500 psi (52 MPa, 517 bar)</b> |               |                    |
| 156971                            | 1/4 npt (m)   | 1/4 (m)            |
| <b>8000 psi (55 MPa, 552 bar)</b> |               |                    |
| 164856                            | 1/4 npt (m)   | 3/8 (m)            |

## Standard 2 Component Hose

| Hose Assembly                       | Length ft (m) | ID in. (mm) | FTS Cable | Standard Braided Scuff Guard | Xtreme-Wrap Scuff Guard | Hose Fittings             |                           | "A" Red Hose | "B" Blue Hose |
|-------------------------------------|---------------|-------------|-----------|------------------------------|-------------------------|---------------------------|---------------------------|--------------|---------------|
|                                     |               |             |           |                              |                         | "A" inlet (f)/ outlet (m) | "B" inlet (f)/ outlet (m) |              |               |
| <b>2000 psi (13.8 MPa, 138 bar)</b> |               |             |           |                              |                         |                           |                           |              |               |
| 246045                              | 50 (15.2)     | 1/4 (6)     | ✓         |                              |                         | -5 JIC                    | -6 JIC                    | 246059       | 246060        |
| 246046                              | 50 (15.2)     | 3/8 (10)    | ✓         |                              |                         | -5 JIC                    | -6 JIC                    | 246061       | 246062        |
| 246047                              | 50 (15.2)     | 1/2 (13)    | ✓         |                              |                         | -8 JIC                    | -10 JIC                   | 246063       | 246064        |
| 246074                              | 50 (15.2)     | 1/4 (6)     |           |                              |                         | -5 JIC                    | -6 JIC                    | 246059       | 246060        |
| 246075                              | 50 (15.2)     | 3/8 (10)    |           |                              |                         | -5 JIC                    | -6 JIC                    | 246061       | 246062        |
| 246076                              | 50 (15.2)     | 1/2 (13)    |           |                              |                         | -8 JIC                    | -10 JIC                   | 246063       | 246064        |
| 246678                              | 50 (15.2)     | 3/8 (10)    | ✓         | ✓                            |                         | -5 JIC                    | -6 JIC                    | 246061       | 246062        |
| 24Y678                              | 50 (15.2)     | 3/8 (10)    | ✓         |                              | ✓                       | -5 JIC                    | -6 JIC                    | 246061       | 246062        |
| 256549                              | 50 (15.2)     | 3/8 (10)    |           | ✓                            |                         | -5 JIC                    | -6 JIC                    | 246061       | 246062        |
| 24Y549                              | 50 (15.2)     | 3/8 (10)    |           |                              | ✓                       | -5 JIC                    | -6 JIC                    | 246069       | 246070        |
| 249587                              | 25 (7.6)      | 1/4 (6)     |           |                              |                         | -5 JIC                    | -6 JIC                    | 246065       | 246066        |
| 261328                              | 25 (7.6)      | 3/8 (10)    |           |                              |                         | -5 JIC                    | -6 JIC                    | 246094       | 246095        |
| 246048                              | 25 (7.6)      | 1/4 (6)     | ✓         |                              |                         | -5 JIC                    | -6 JIC                    | 246065       | 246066        |
| 246049                              | 25 (7.6)      | 3/8 (10)    | ✓         |                              |                         | -5 JIC                    | -6 JIC                    | 246094       | 246095        |
| <b>3500 psi (24.1 MPa, 241 bar)</b> |               |             |           |                              |                         |                           |                           |              |               |
| 246052                              | 50 (15.2)     | 1/4 (6)     | ✓         |                              |                         | -5 JIC                    | -6 JIC                    | 246067       | 246068        |
| 246053                              | 50 (15.2)     | 3/8 (10)    | ✓         |                              |                         | -5 JIC                    | -6 JIC                    | 246069       | 246070        |
| 246054                              | 50 (15.2)     | 1/2 (13)    | ✓         |                              |                         | -8 JIC                    | -10 JIC                   | 246071       | 246072        |
| 249588                              | 50 (15.2)     | 3/8 (10)    |           |                              |                         | -5 JIC                    | -6 JIC                    | 246069       | 246070        |
| 246679                              | 50 (15.2)     | 3/8 (10)    | ✓         | ✓                            |                         | -5 JIC                    | -6 JIC                    | 246069       | 246070        |
| 24Y679                              | 50 (15.2)     | 3/8 (10)    | ✓         |                              | ✓                       | -5 JIC                    | -6 JIC                    | 246069       | 246070        |
| 256548                              | 50 (15.2)     | 1/2 (13)    | ✓         | ✓                            |                         | -8 JIC                    | -10 JIC                   | 246071       | 246072        |
| 261335                              | 50 (15.2)     | 1/2 (13)    |           |                              |                         | -8 JIC                    | -10 JIC                   | 246071       | 246072        |
| <b>5000 psi (34.5 MPa, 345 bar)</b> |               |             |           |                              |                         |                           |                           |              |               |
| 261332                              | 25 (7.6)      | 3/8 (10)    |           |                              |                         | -5 JIC                    | -6 JIC                    |              |               |
| 262203                              | 50 (15.2)     | 3/8 (10)    | ✓         |                              |                         | -5 JIC                    | -6 JIC                    | 15E751       | 15E752        |

## RTD 2-Component Hose (for use with GCA Controlled Reactors)

| Hose Assembly                       | Length ft (m) | ID in. (mm) | RTD Cable | Standard Braided Scuff Guard | Xtreme-Wrap Scuff Guard | CAN Cable | Hose Fittings             |                           | "A" Red Hose | "B" Blue Hose |
|-------------------------------------|---------------|-------------|-----------|------------------------------|-------------------------|-----------|---------------------------|---------------------------|--------------|---------------|
|                                     |               |             |           |                              |                         |           | "A" inlet (f)/ outlet (m) | "B" inlet (f)/ outlet (m) |              |               |
| <b>2000 psi (13.8 MPa, 138 bar)</b> |               |             |           |                              |                         |           |                           |                           |              |               |
| 24K240                              | 50 (15.2)     | 3/8 (10)    | ✓         | ✓                            |                         |           | -5 JIC                    | -6 JIC                    | 246061       | 246062        |
| 24Y240                              | 50 (15.2)     | 3/8 (10)    | ✓         |                              | ✓                       |           | -5 JIC                    | -6 JIC                    | 246061       | 246062        |
| 24K394                              | 50 (15.2)     | 3/8 (10)    | ✓         | ✓                            |                         | ✓         | -5 JIC                    | -6 JIC                    | 246061       | 246062        |
| 24T839                              | 50 (15.2)     | 3/8 (10)    | ✓         |                              |                         |           | -5 JIC                    | -6 JIC                    | 246061       | 246062        |
| 24Y394                              | 50 (15.2)     | 3/8 (10)    | ✓         |                              | ✓                       | ✓         | -5 JIC                    | -6 JIC                    | 246061       | 246062        |
| 24N000                              | 50 (15.2)     | 1/2 (13)    | ✓         | ✓                            |                         |           | -8 JIC                    | -10 JIC                   | 246063       | 246064        |

| Hose Assembly                       | Length ft (m) | ID in. (mm) | RTD Cable | Standard Braided Scuff Guard | Xtreme-Wrap Scuff Guard | CAN Cable | Hose Fittings            |                          | "A" Red Hose | "B" Blue Hose |
|-------------------------------------|---------------|-------------|-----------|------------------------------|-------------------------|-----------|--------------------------|--------------------------|--------------|---------------|
|                                     |               |             |           |                              |                         |           | "A" inlet (f)/outlet (m) | "B" inlet (f)/outlet (m) |              |               |
| 24N001                              | 50 (15.2)     | 1/2 (13)    | ✓         | ✓                            |                         | ✓         | -8 JIC                   | -10 JIC                  | 246063       | 246064        |
| <b>3500 psi (24.1 MPa, 241 bar)</b> |               |             |           |                              |                         |           |                          |                          |              |               |
| 24K241                              | 50 (15.2)     | 3/8 (10)    | ✓         | ✓                            |                         |           | -5 JIC                   | -6 JIC                   | 246069       | 246070        |
| 24Y241                              | 50 (15.2)     | 3/8 (10)    | ✓         |                              | ✓                       |           | -5 JIC                   | -6 JIC                   | 246069       | 246070        |
| 24K395                              | 50 (15.2)     | 3/8 (10)    | ✓         | ✓                            |                         | ✓         | -5 JIC                   | -6 JIC                   | 246069       | 246070        |
| 24Y395                              | 50 (15.2)     | 3/8 (10)    | ✓         |                              | ✓                       | ✓         | -5 JIC                   | -6 JIC                   | 246069       | 246070        |
| 24U743                              | 50 (15.2)     | 3/8 (10)    | ✓         |                              |                         |           | -5 JIC                   | -6 JIC                   | 246069       | 246070        |
| 24N002                              | 50 (15.2)     | 1/2 (13)    | ✓         | ✓                            |                         |           | -8 JIC                   | -10 JIC                  | 246071       | 246072        |
| 24N003                              | 50 (15.2)     | 1/2 (13)    | ✓         | ✓                            |                         | ✓         | -8 JIC                   | -10 JIC                  | 246071       | 246072        |

## Airless 2 Component Hose

| Hose Assembly                       | Length ft (m) | ID in. (mm) |          | FTS Cable | Standard Braided Scuff Guard | Hose Fittings            |                          | "A" Red Hose | "B" Blue Hose |  |
|-------------------------------------|---------------|-------------|----------|-----------|------------------------------|--------------------------|--------------------------|--------------|---------------|--|
|                                     |               | "A"         | "B"      |           |                              | "A" inlet (f)/outlet (m) | "B" inlet (f)/outlet (m) |              |               |  |
| <b>5000 psi (34.5 MPa, 345 bar)</b> |               |             |          |           |                              |                          |                          |              |               |  |
| 248907                              | 50 (15.2)     | 1/4 (6)     | 3/8 (10) | ✓         |                              | -5 JIC                   | -6 JIC                   | 15E750       | 15E752        |  |
| 248908                              | 50 (15.2)     | 3/8 (10)    | 3/8 (10) | ✓         |                              | -5 JIC                   | -6 JIC                   | 15E751       | 15E752        |  |
| 262727                              | 50 (15.2)     | 1/2 (13)    | 1/4 (6)  | ✓         |                              | -8 JIC                   | -6 JIC                   | 262719       | 262718        |  |
| 262728                              | 50 (15.2)     | 1/2 (13)    | 3/8 (10) | ✓         |                              | -8 JIC                   | -6 JIC                   | 262719       | 15E752        |  |
| 262730                              | 50 (15.2)     | 1/2 (13)    | 1/2 (13) | ✓         |                              | -8 JIC                   | -10 JIC                  | 262719       | 262720        |  |

## Custom Application 2 Component Hose

| Hose Assembly                       | Length ft (m) | ID in. (mm) |          | FTS Cable | Standard Braided Scuff Guard | Hose Fittings            |                          | "A" Red Hose | "B" Blue Hose |  |
|-------------------------------------|---------------|-------------|----------|-----------|------------------------------|--------------------------|--------------------------|--------------|---------------|--|
|                                     |               | "A"         | "B"      |           |                              | "A" inlet (f)/outlet (m) | "B" inlet (f)/outlet (m) |              |               |  |
| <b>2000 psi (13.8 MPa, 138 bar)</b> |               |             |          |           |                              |                          |                          |              |               |  |
| 255089                              | 50 (15.2)     | 1/4 (6)     | 3/8 (10) | ✓         | ✓                            | -5 JIC                   | -6 JIC                   | 246059       | 246062        |  |
| 261329                              | 50 (15.2)     | 3/8 (10)    | 3/8 (10) | ✘         |                              | -5 JIC                   | -6 JIC                   | 246061       | 246062        |  |
| <b>3500 psi (24.1 MPa, 241 bar)</b> |               |             |          |           |                              |                          |                          |              |               |  |
| 247164                              | 50 (15.2)     | 1/4 (6)     | 3/8 (10) | ✓         | ✓                            | -5 JIC                   | -6 JIC                   | 246067       | 246070        |  |
| 261336                              | 50 (15.2)     | 3/8 (10)    | 1/2 (13) | ✓         |                              | -5 JIC                   | -6 JIC                   | 246069       | 246072        |  |
| 261337                              | 50 (15.2)     | 1/4 (6)     | 3/8 (10) | ‡         |                              | -5 JIC                   | -6 JIC                   | 246067       | 246070        |  |
| 261334                              | 50 (15.2)     | 3/8 (10)    | 3/8 (10) | ‡         |                              | -5 JIC                   | -6 JIC                   | 246069       | 246070        |  |

✘ Stranded wire (no connectors).

‡ Two FTS cables and two sets of standard wires.

## Fluid Temperature Sensor (FTS) Kits

| Part No.                            | "A" Side    |              |           | "B" Side    |              |           |
|-------------------------------------|-------------|--------------|-----------|-------------|--------------|-----------|
|                                     | Inlet       | Outlet       | FTS Probe | Inlet       | Outlet       | FTS Probe |
| <b>5000 psi (34.5 MPa, 345 bar)</b> |             |              |           |             |              |           |
| 261669                              | -5 JIC      | -5 JIC       | ✓         | -6 JIC      | -6 JIC       |           |
| 261670                              | -5 JIC      | 1/4 NPT      |           | -6 JIC      | 3/8 NPT      | ✓         |
| <b>7250 psi (50 MPa, 500 bar)</b>   |             |              |           |             |              |           |
| 24M943                              | 1/2 npt (f) | 1/2 (npt (f) | ✓         | 1/2 npt (f) | 1/2 (npt (f) |           |

## Fluid Temperature Sensor Kits (FTS, RTD; for use with GCA Controlled Systems)





| Part No.                            | "A" Side    |              |           | "B" Side    |              |           |
|-------------------------------------|-------------|--------------|-----------|-------------|--------------|-----------|
|                                     | Inlet       | Outlet       | RTD Probe | Inlet       | Outlet       | RTD Probe |
| <b>5000 psi (34.5 MPa, 345 bar)</b> |             |              |           |             |              |           |
| 24K207                              | -5 JIC      | -5 JIC       | ✓         | -6 JIC      | -6 JIC       |           |
| <b>7250 psi (50 MPa, 500 bar)</b>   |             |              |           |             |              |           |
| 24M944                              | 1/2 npt (f) | 1/2 (npt (f) | ✓         | 1/2 npt (f) | 1/2 (npt (f) |           |

### FTS kits contain:



- FTS Sensor
- FTS coupler fitting (5b) for equal length on other line.
- Adapter fittings as necessary. See **Adapter Fittings**, page 3.
- Foam tube insulation to cover fittings and FTS.
- 3.75 in. (95.25 mm) air line jumper hose (except kit 261670).

# Warnings

The following warnings are for the setup, use, grounding, maintenance, and repair of this equipment. The exclamation point symbol alerts you to a general warning and the hazard symbol refers to procedure-specific risk. When these symbols appear in the body of this manual, refer back to these Warnings. Product-specific hazard symbols and warnings not covered in this section may appear throughout the body of this manual where applicable.

|  <b>WARNING</b> |   |
|--|---|
|                 | <p><b>ELECTRIC SHOCK HAZARD</b></p> <p>The hoses must be grounded. Improper grounding, set-up or usage of the hoses can cause electric shock.</p> <ul style="list-style-type: none"> <li>• Turn off and disconnect power before installing or servicing hoses.</li> <li>• Connect to grounded power source.</li> <li>• All electrical wiring must be done by a qualified electrician and comply with all local codes and regulations.</li> <li>• Never cut or puncture a hose cover.</li> <li>• Do not expose to rain. Store indoors.</li> </ul>  |
|                | <p><b>SKIN INJECTION HAZARD</b></p> <p>High-pressure fluid from hose leaks, or ruptured components will pierce skin. This may look like just a cut, but it is a serious injury that can result in amputation. <b>Get immediate surgical treatment.</b></p> <ul style="list-style-type: none"> <li>• Inspect hose before each use for cuts, bulges, kinks or any other damage.</li> <li>• Replace damaged hose immediately.</li> <li>• Replace hoses proactively at regular intervals based on your operating conditions.</li> <li>• Tighten all fluid connections before operating the equipment.</li> <li>• Keep clear of leaks.</li> <li>• Do not stop or deflect leaks with your hand, body, glove, or rag.</li> <li>• Never exceed hose Maximum Pressure or Temperature ratings.</li> <li>• Only use chemicals that are compatible with wetted parts. See <b>Technical Data</b> in this manual. Read MSDSs and fluid and solvent manufacturer's recommendations.</li> <li>• Follow the <b>Pressure Relief Procedure</b> when you stop spraying/dispensing and before cleaning, checking, or servicing equipment.</li> </ul> |
|               | <p><b>THERMAL EXPANSION HAZARD</b></p> <p>Fluids subjected to heat in confined spaces, including hoses, can create a rapid rise in pressure due to the thermal expansion. Over-pressurization can result in equipment rupture and serious injury.</p> <ul style="list-style-type: none"> <li>• Open a valve to relieve the fluid expansion during heating.</li> <li>• Replace hoses proactively at regular intervals based on your operating conditions.</li> </ul>   |
|               | <p><b>BURN HAZARD</b></p> <p>Equipment surfaces and fluid that's heated can become very hot during operation. To avoid severe burns:</p> <ul style="list-style-type: none"> <li>• Do not touch hot fluid or equipment.</li> </ul>   |

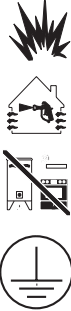
# ! WARNING

|   |  |
|---|--|
|    | <p><b>TOXIC FLUID OR FUMES HAZARD</b></p> <p>Toxic fluids or fumes can cause serious injury or death if splashed in the eyes or on skin, inhaled, or swallowed.</p> <ul style="list-style-type: none"> <li>• Read MSDSs to know the specific hazards of the fluids you are using.</li> <li>• Store hazardous fluid in approved containers, and dispose of it according to applicable guidelines.</li> <li>• Always wear chemically impermeable gloves when spraying, dispensing, or cleaning equipment.</li> </ul>   |
|    | <p><b>FIRE AND EXPLOSION HAZARD</b></p> <p>Flammable fumes, such as solvent and paint fumes, in <b>work area</b> can ignite or explode. To help prevent fire and explosion:</p> <ul style="list-style-type: none"> <li>• Use equipment only in well ventilated area.</li> <li>• Eliminate all ignition sources; such as pilot lights, cigarettes, portable electric lamps, and plastic drop cloths (potential static arc).</li> <li>• Keep work area free of debris, including solvent, rags and gasoline.</li> <li>• Do not plug or unplug power cords, or turn power or light switches on or off when flammable fumes are present.</li> <li>• Ground all equipment in the work area. See <b>Grounding</b> instructions.</li> <li>• Use only grounded hoses.</li> <li>• Hold gun firmly to side of grounded pail when triggering into pail.</li> <li>• If there is static sparking or you feel a shock, <b>stop operation immediately</b>. Do not use equipment until you identify and correct the problem.</li> <li>• Keep a working fire extinguisher in the work area.</li> </ul>  |
|  | <p><b>EQUIPMENT MISUSE HAZARD</b></p> <p>Misuse can cause death or serious injury.</p> <ul style="list-style-type: none"> <li>• Do not operate the unit when fatigued or under the influence of drugs or alcohol.</li> <li>• Do not exceed the maximum working pressure or temperature rating of the lowest rated system component. See <b>Technical Data</b> in all equipment manuals.</li> <li>• Use fluids and solvents that are compatible with equipment wetted parts. See <b>Technical Data</b> in all equipment manuals. Read fluid and solvent manufacturer's warnings. For complete information about your material, request MSDS from distributor or retailer.</li> <li>• Do not leave the work area while equipment is energized or under pressure. Turn off all equipment and follow the <b>Pressure Relief Procedure</b> when equipment is not in use.</li> <li>• Check equipment daily. Repair or replace worn or damaged parts immediately with genuine manufacturer's replacement parts only.</li> <li>• Do not alter or modify equipment.</li> <li>• Use equipment only for its intended purpose. Call your distributor for information.</li> <li>• Route hoses and cables away from traffic areas, sharp edges, moving parts, and hot surfaces.</li> <li>• Do not kink or over bend hoses or use hoses to pull equipment.</li> <li>• Keep children and animals away from work area.</li> <li>• Comply with all applicable safety regulations.</li> </ul> |







# ! WARNING



|   |   |
|---|---|
|  | <p><b>PERSONAL PROTECTIVE EQUIPMENT</b></p> <p>You must wear appropriate protective equipment when operating, servicing, or when in the operating area of the equipment to help protect you from serious injury, including eye injury, hearing loss, inhalation of toxic fumes, and burns. This equipment includes but is not limited to:</p> <ul style="list-style-type: none"> <li>• Protective eyewear, and hearing protection.</li> <li>• Respirators, protective clothing, and gloves as recommended by the fluid and solvent manufacturer.</li> </ul> |
|---|---|

## Important Two-Component Material Information



### Isocyanate Conditions

|  |   |   |   |   |  |  |
|--|---|---|---|---|--|--|
|   |  |  |  |  |  |  |
| <p>Spraying or dispensing materials containing isocyanates creates potentially harmful mists, vapors, and atomized particulates.</p> <p>Read material manufacturer's warnings and material MSDS to know specific hazards and precautions related to isocyanates.</p> <p>Prevent inhalation of isocyanate mists, vapors, and atomized particulates by providing sufficient ventilation in the work area. If sufficient ventilation is not available, a supplied-air respirator is required for everyone in the work area.</p> <p>To prevent contact with isocyanates, appropriate personal protective equipment, including chemically impermeable gloves, boots, aprons, and goggles, is also required for everyone in the work area.</p> |   |   |   |   |  |  |

### Keep Components A and B Separate

|   |  |   |  |  |  |  |
|---|--|---|--|--|--|--|
|    |  |  |  |  |  |  |
| <p>Cross-contamination can result in cured material in fluid lines which could cause serious injury or damage equipment. To prevent cross-contamination of the equipment's wetted parts, <b>never</b> interchange component A (isocyanate) and component B (resin) parts.</p> |  |   |  |  |  |  |

### Material Self-ignition

|   |   |  |  |  |  |  |
|---|---|--|--|--|--|--|
|    |  |  |  |  |  |  |
| <p>Some materials may become self-igniting if applied too thickly. Read material manufacturer's warnings and material MSDS.</p> |   |  |  |  |  |  |

## Moisture Sensitivity of Isocyanates

Isocyanates (ISO) are catalysts used in two component foam and polyurea coatings. ISO will react with moisture (such as humidity) to form small, hard, abrasive crystals, which become suspended in the fluid. Eventually a film will form on the surface and the ISO will begin to gel, increasing in viscosity. If used, this partially cured ISO will reduce performance and the life of all wetted parts.

**NOTE:** The amount of film formation and rate of crystallization varies depending on the blend of ISO, the humidity, and the temperature.

To prevent exposing ISO to moisture:

- Always use a sealed container with a desiccant dryer in the vent, or a nitrogen atmosphere. **Never** store ISO in an open container.
- Keep the ISO lube pump reservoir (if installed) filled with Graco® Throat Seal Liquid (TSL™), Part 206995. The lubricant creates a barrier between the ISO and the atmosphere.
- Use moisture-proof hoses specifically designed for ISO, such as those supplied with your system.
- Never use reclaimed solvents, which may contain moisture. Always keep solvent containers closed when not in use.
- Never use solvent on one side if it has been contaminated from the other side.
- Always lubricate threaded parts with ISO pump oil or grease when reassembling.

## Foam Resins with 245 fa Blowing Agents

Some foam blowing agents will froth at temperatures above 90°F (33°C) when not under pressure, especially if agitated. To reduce frothing, minimize preheating in a circulation system.

## Changing Materials

- When changing materials, flush the equipment multiple times to ensure it is thoroughly clean.
- Always clean the fluid inlet strainers after flushing.
- Check with your material manufacturer for chemical compatibility.
- Most materials use ISO on the A side, but some use ISO on the B side.
- Epoxies often have amines on the B (hardener) side. Polyureas often have amines on the B (resin) side.

# Installation

## Description



The heated hose maintains proper fluid temperature while spraying.

Fluid hoses are marked with red tape for ISO/hardener/minor volume side, blue tape for RES/resin/major volume side. Fittings have different sized threads to prevent incorrect connection, which can cause fluid crossover and permanently damage the hose.

Hoses are 50 ft (15.2 m) or 25 ft (7.6 m) long. The whip hose is 10 ft (3 m) long or less.

 To heat the major volume hose only in a wide ratio system, see **15F144 Hose Wire Jumper**, page 30.

## Connect Whip Hose to Gun or Gun Manifold



Install hose in a helix configuration for:

- Easy gun movement
- Large spraying motion
- Ability to spray in tight areas and odd angles
- Reduced operator fatigue
- Maximum hose life

1. Overlap A and B component hoses and assemble to gun or gun manifold fittings as shown in FIG. 1.

2. Tighten fittings to A and B component hoses. Ensure hose remains flat after fittings are tightened. Loosen and retighten fittings as necessary to eliminate any torque on hoses. This will help achieve a flat profile on the hose.

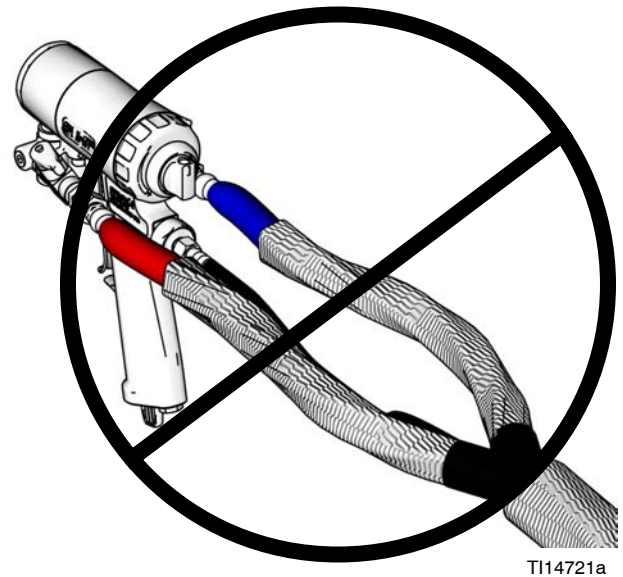
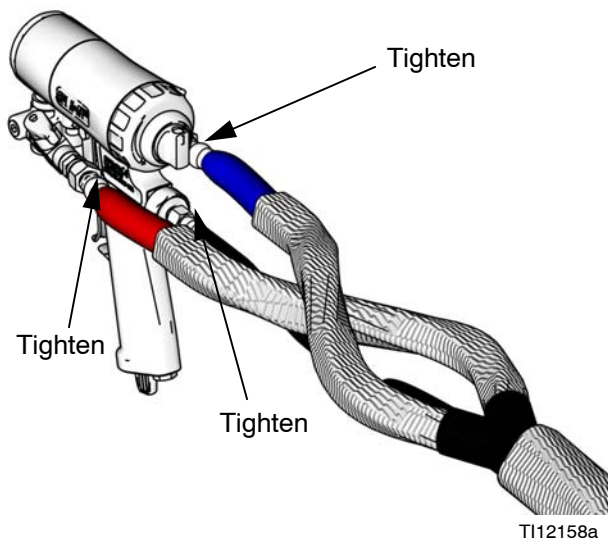
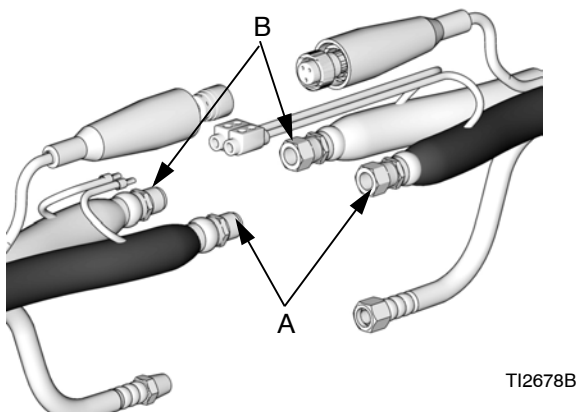

FIG. 1

## Connect Heated Hoses



1. Lay heated hoses end to end, matching the color coding. Red for component A (ISO), blue for component B (RES).



**FIG. 2**

TI2678B

2. Connect fluid hoses (1, 2) and tighten. See maximum torque specifications below and FIG. 3. Do not over-torque.

Torque 1/4 in. (6.4 mm) and 3/8 in. (9.5 mm) ID hoses to:

- A side to 14 ft-lb (19 N•m).
- B side to 20 ft-lb (27 N•m).

Torque 1/2 in. (13 mm) ID hoses to:

- A side to 43 ft-lb (58 N•m).
- B side to 55 ft-lb (74 N•m).

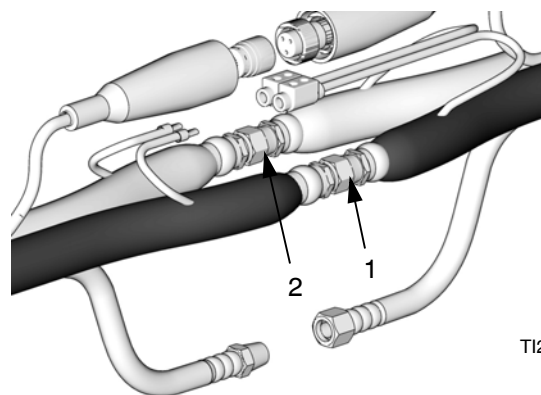

TI2679B

**FIG. 3**

 Do not connect the main air supply at this time.

Some insulated heated hoses do not contain an air hose.

3. Connect air hoses (3).

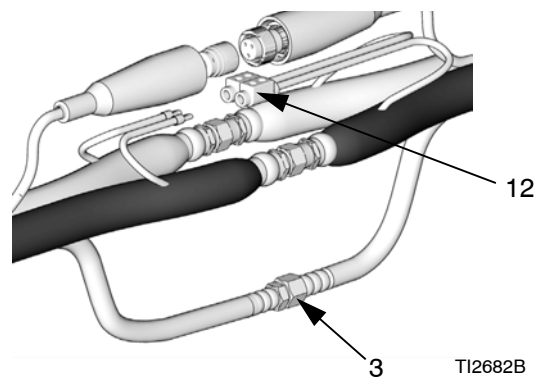

TI2682B

**FIG. 4**

4. Connect electrical wires.
  - a. Ensure electrical wires ends are 5/8 in. (15.9 mm) long. If they are not, use a sharp scissors to strip all four wire ends to the correct length. See Strip Length Gauge for correct length.

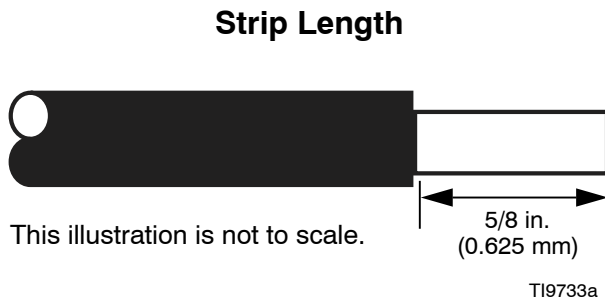

**FIG. 5**

- Be careful not to cut or nick copper strands. If more than five strands are cut or nicked, trim wire and re-strip.
- New hoses are pre-stripped at correct length; remove insulation to expose bare wire.
  - a. Ensure strip length is correct by fitting ferrule over exposed wire. Ferrule should be flush with wire end. See FIG. 6.
- On some older heated hoses wire insulation will not fit inside ferrule insulator. In these cases, use scissors to split and remove ferrule insulator.

- b. If wire is short of ferrule end, adjust strip length accordingly. If bare wire is protruding from ferrule, trim flush to ferrule end. See FIG. 6.

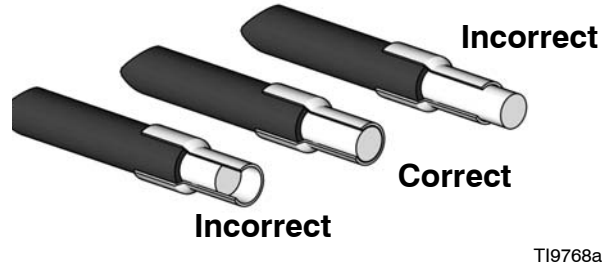

**FIG. 6**

- c. Remove ferrule and apply oxide inhibitor to bare wire. See FIG. 7.
- d. Reinsert wire in ferrule and apply more oxide inhibitor to ferrule and wire end.

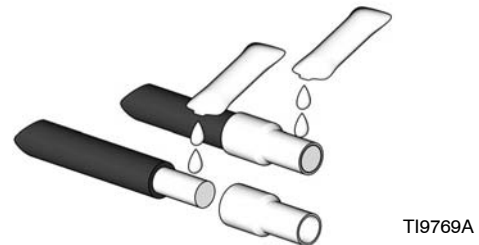
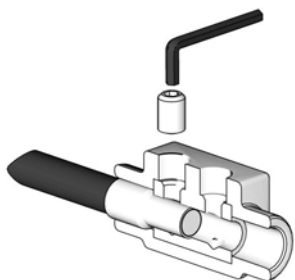

**FIG. 7**

5. Pair electrical wires as follows: A-Hose to A-Hose; B-Hose to B-Hose.

 When connecting first hose section to proportioner, wire pairing does not make a difference.

- a. Insert one wire from heated hose into connector. Ensure that ferrule is mating with connector insert. See FIG. 8.



TI9770A

**FIG. 8: Insert Wire and Setscrew**

- b. Thread in setscrew and use hex wrench to torque setscrew to 60 in-lbs (6.78 N•m).

 To reach approximately 60 in-lbs (6.78 N•m), complete 4.5 revolutions with hex wrench after setscrew comes in contact with ferrule.

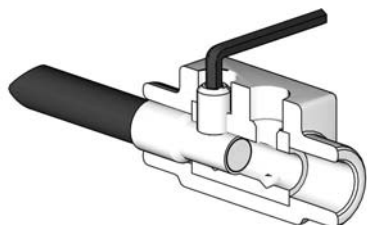

TI9779A

**FIG. 9: Torque Setscrew**

- c. Insert remaining wire from pair into connector; ensure proper insertion depth. Thread setscrew and torque to 60 in-lbs (6.78 N•m); see sub-step B. See FIG. 8 and FIG. 9.

- d. Repeat sub-steps A through C for remaining wire pair.

- e. Re-torque all four setscrews to 60 in-lbs (6.78 N•m).

 When torqued to 60 in-lbs (6.78 N•m) setscrews will be approximately flush with connector. See FIG. 10.

- f. Insert cap plugs over setscrews. See FIG. 10.

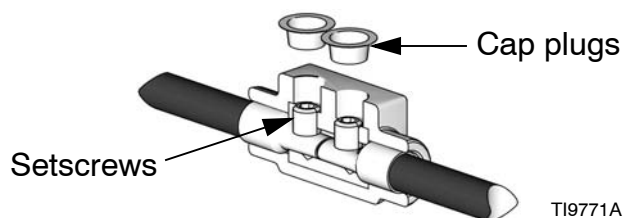

TI9771A

**FIG. 10**

- g. Wrap connector and wire on each side of connector in black electrical tape to help seal out moisture. Ensure 1 in. (25.4 mm) of wire on each side of connector is wrapped.

6. For non-RTD hoses only, connect cables (4). Slide insulator sleeves (S) over connection. Leave slack in cables as stress relief to prevent cable failure.

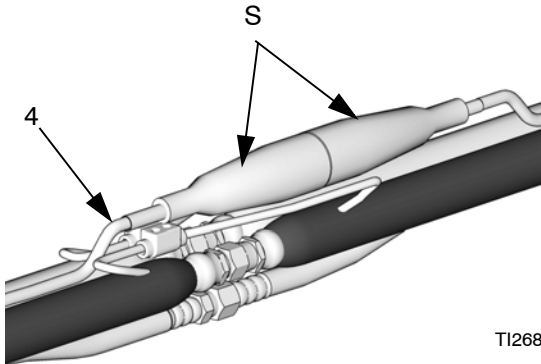

TI2683B

FIG. 11

7. For RTD 2-component hoses only, connect RTD cables (4) and CAN cables (5) if present.

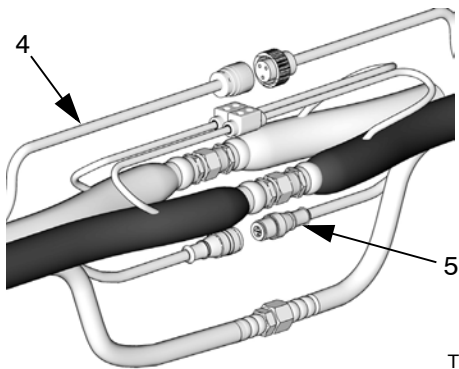

TI18358a

FIG. 12

8. Repeat for additional hoses.
9. See **Connect FTS and Heated Dual Whip Hose**, page 18, or **Connect FTS with a Non-Heated Whip Hose or Remote Mix Manifold**, page 20.







A series of horizontal lines spanning the width of the page, intended for writing or drawing.

## Connect FTS and Heated Dual Whip Hose

### NOTICE

To prevent damage to probe, do not kink or excessively bend hose. Do not coil hose tighter than the minimum bend radius of 3 ft (0.9 m). Do not subject hose to excessive weight, impact, or other abuse.

 See FIG. 13 on page 19.

 **For 1/2 in. (13 mm) ID fluid hoses only:** Prior to connecting the FTS, remove the adapters from the proportioner fluid manifold and install them on the male ends of the hoses (1 and 2). Torque the A side hose to a maximum of 43 ft-lbs (58 N•m) and the B side hose to a maximum of 55 ft-lbs (74 N•m). Continue on to step 1.

1. Assemble JIC swivel fitting (5e) in female end of temp sensor (5a). Do not bend or kink probe. Torque connection to 14 ft-lbs (19 N•m). Do not over-torque. Assemble JIC swivel fitting (5d) into female end of B hose coupler (5b). Torque to a maximum of 20 ft-lbs (27 N•m). Do not over-torque.
2. Carefully inset FTS probe into the A hose (1) section from the proportioner. Do not bend or kink probe. Connect to A side whip (6a). Torque fitting connections to 14 ft-lbs (19 N•m). Do not over-torque.
3. Connect the B hose coupler to the B hose section (2) and B side whip (6b). Torque fitting connections to 20 ft-lbs (27 N•m). Do not over-torque.

4. Connect ground wire (K) of whip hose to the ground screw on the FTS (5a).

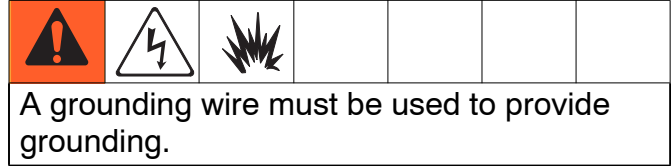

 Whip hose ground wire (K) must be connected to the ground screw on the FTS (5a) in order to drain static from the gun. If the FTS is not directly connected to the whip hose, a hose that includes a separate ground wire must be used between the FTS and whip hose. Connect ground through a hose marked as not having the FTS cable selected from the "Standard 2 Component Hose" table in the front of this manual.

5. Connect the electrical connectors (12).
6. Connect the FTS air line coupler (5c) between air hoses (3 and 8).
7. Connect the sensor cable of the hose (4) to the sensor cable of the FTS (5a). For non-RTD hoses, slide the insulator sleeves (S) over the connection. Leave slack in the cables to provide stress relief and to prevent cable failure or errors.
8. See **Check Hoses for Leaks**, page 21.

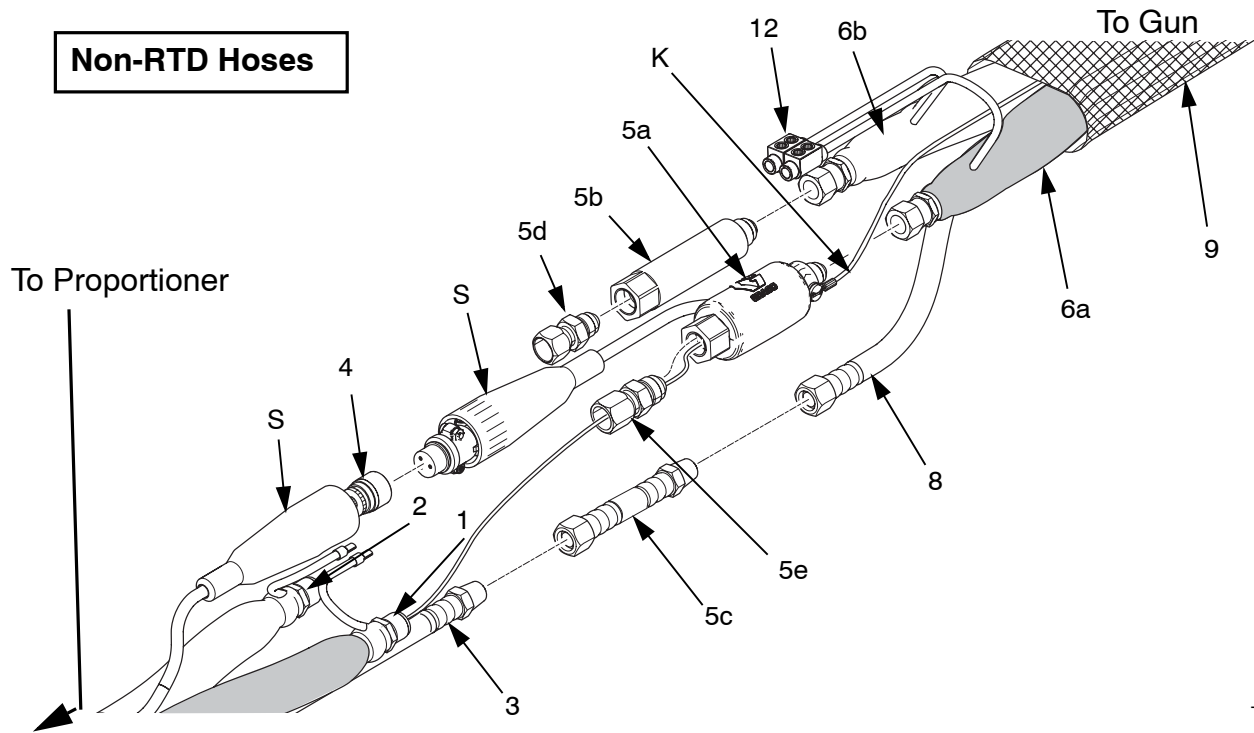

TI17091b

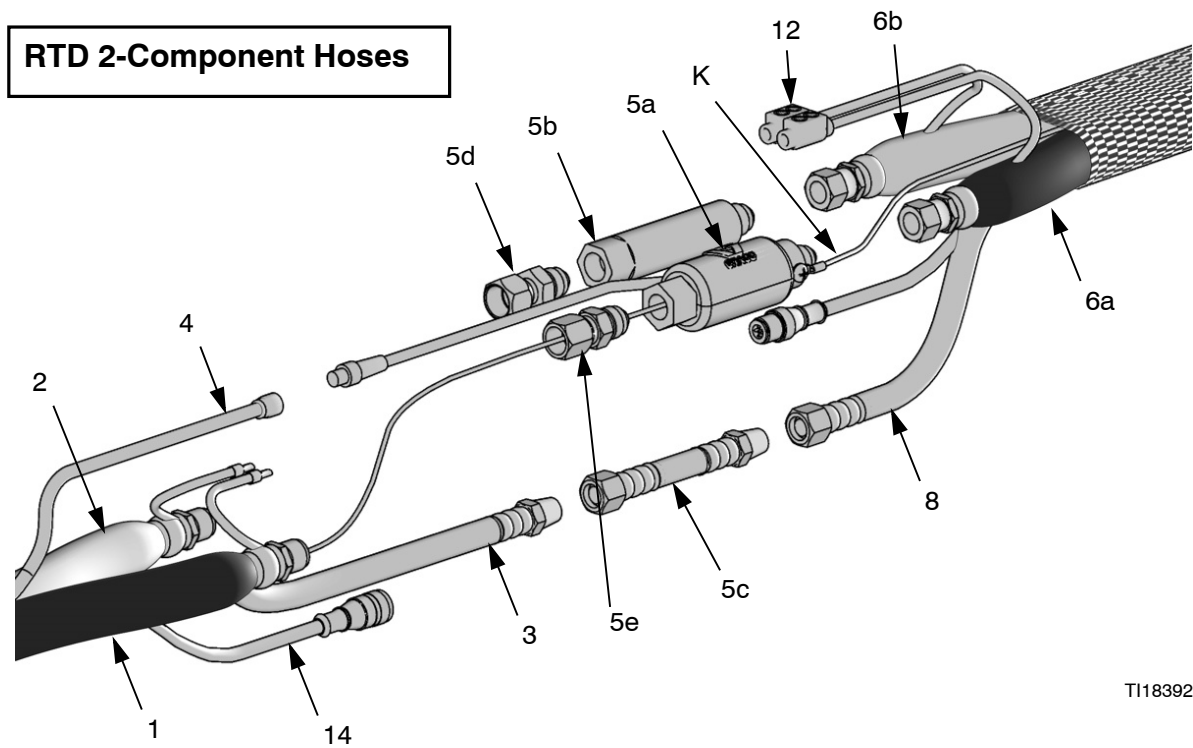

TI18392b

**FIG. 13**

## Connect FTS with a Non-Heated Whip Hose or Remote Mix Manifold

### NOTICE

To prevent damage to probe, do not kink or excessively bend hose. Do not coil hose tighter than the minimum bend radius of 3 ft (0.9 m). Do not subject hose to excessive weight, impact, or other abuse.

1. Carefully extend FTS probe (H) into the hose section from the proportioner. Do not bend or kink probe. **Insert probe in major volume (resin) side on systems which are not 1:1 mix ratio.**

2. Connect FTS (5) to mating assembly.

3. Connect fluid hoses to FTS.



To use 1/2 in. (13 mm) ID fluid hoses, remove the adapters from the proportioner fluid manifold and install them in the FTS swivel inlets.

4. Install one connector (12) between wires. Refer to page 13 for instructions.

5. Connect hose assembly cable (4) to FTS cable (part of 5). Slide insulator sleeves (S) over connection. Leave slack in cables as stress relief, to prevent cable failure.

6. Connect appropriate ground wire.

7. See **Check Hoses for Leaks**, page 21.

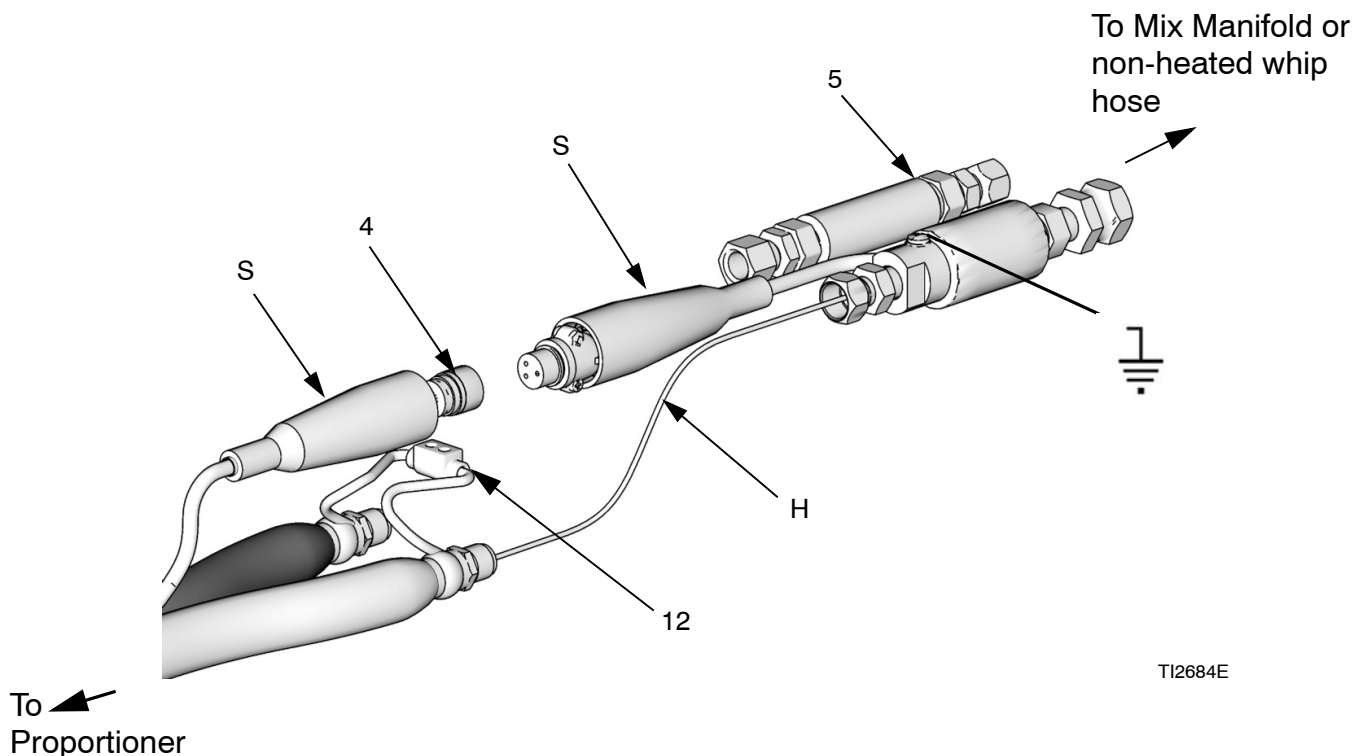

## Check Hoses for Leaks

1. Grease with Fusion<sup>®</sup> grease and connect fluid hoses to proportioner fluid manifold (M). Red for hardener (ISO), blue for resin (RES).

 The manifold hose adapters (N, P) allow use of 1/4 in (6.4 mm) and 3/8 in (9.5 mm) ID fluid hoses. To check adapter tightness, torque 1/4 in. and 3/8 in. ID hoses to:

- A side (N) to 14 ft-lb (19 N•m).
- B side (P) to 20 ft-lb (27 N•m).

To use 1/2 in. (13 mm) ID fluid hoses, remove the adapters (N, P) from the proportioner fluid manifold and install them in the FTS or 3/8 in. ID hose inlets.

Torque 1/2 in. ID hoses to:

- A side (N) to 43 ft-lb (58 N•m).
- B side (P) to 55 ft-lb (74 N•m).

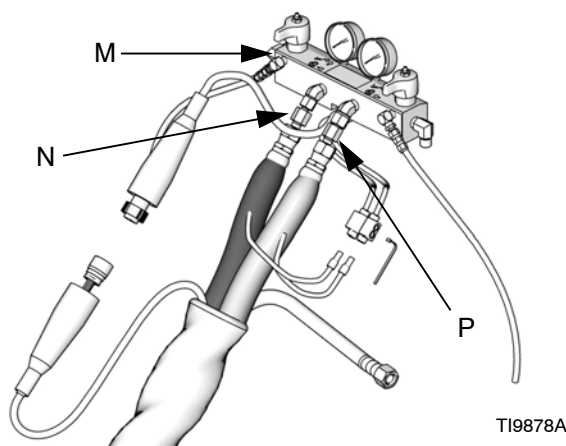

**FIG. 14**

2. For spray guns, close fluid valves on gun fluid manifold. Remove manifold from gun, see gun manual. Connect fluid whip hoses to manifold.
3. Check that all equipment is properly grounded. See proportioner manual.

4. Pressure check hose. See proportioner manual for priming instructions. After all lines are free of air, check for leaks. If there are leaks, relieve pressure as instructed in proportioner manual. Tighten connections, then pressurize again to ensure leaks have stopped. Relieve pressure.

## Protective Covering

1. Wrap **all** fluid hose connections with electrical tape.

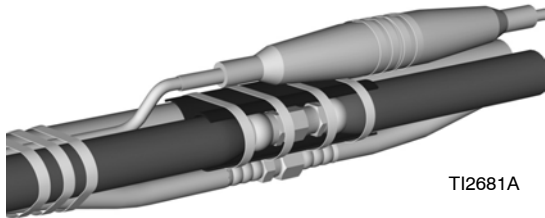

**FIG. 15**

---

2. Fold wire back on hose to ensure adequate strain relief. Wrap **all** electrical connections and cable connections with electrical tape to protect them from pulling apart and abrasion.



Leave CAN cable connector (if used) accessible at whip hose joint for connector to the Remote Display Module Kit (if ordered).

3. Install protective cover (see **Accessories**, page 32), or wrap hose bundle with duct tape to protect foam.
4. For hoses that include the standard braided protective scuff cover, unroll excess cover over hose and electrical connections. Tape securely.
5. For hoses that include Xtreme-Wrap protective scuff sleeve, pull just enough excess length over hose and electrical connections. Tape securely.

**NOTE:** Xtreme-Wrap protective scuff sleeve will contract when heated. Use only as much length as necessary to cover connections and allow excess to remain slack.

# Operation



Do not operate a coiled hose. A coiled hose creates uneven heat buildup which can result in hose rupture and cause serious injury, including fluid injection.

Maximum hose operating temperature is 180°F (82°C). If using hose without an FTS, measure hose temperature to ensure it does not exceed 180°F (82°C).

Hose must be properly supported to avoid excessive strain due to weight, bending, sharp edges, or stress caused by running over a roof edge.

Fluids subjected to heat in confined spaces, including hoses, can create a rapid rise in pressure due to the thermal expansion. Over-pressurization can result in equipment rupture and serious injury.

- Open a valve to relieve the fluid expansion during heating.
- Replace hoses proactively at regular intervals based on your operating conditions.

1. Connect air hose to main air supply, if equipped.
2. Connect electrical connectors (12) to connector from fluid manifold (M) or accessory control box. See **Connect Heated Hoses**, page 13. Connect hose cable (4) to cable from proportioner fluid manifold or accessory control box. Wrap connections with electrical tape.

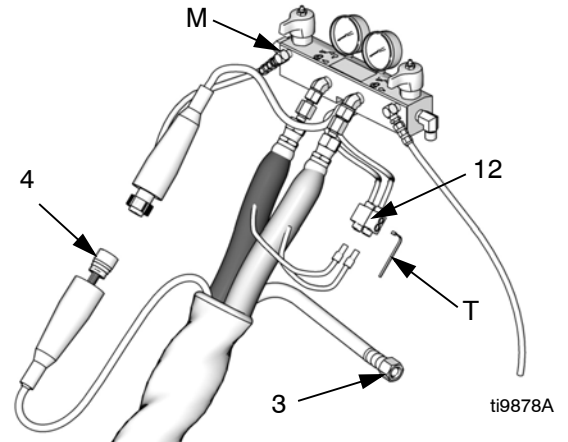

**FIG. 16**

3. Connect to spray gun. See gun manual.
4. Connect whip air hose to gun air inlet if equipped. See gun manual.
5. Follow setup, startup, and operation procedures in proportioner manual.

## Fluid Temperature Sensor (FTS) Calibration

 Calibrate the FTS ONLY at initial startup (the first time the unit is operated) and any time the hose length changes.

1. Before turning on the unit, ensure all hoses and cables are properly connected. To ensure that the FTS in the hose is at the same temperature as the heaters, keep heat off and store the hose FTS near the machine for several minutes.
2. While holding down the temperature unit button (Fahrenheit - "F" or Celsius - "C") turn the proportioner main power ON.
3. Hold the temperature unit button until temperature is shown on the display. The fluid temperature sensor is now correctly calibrated.

# Maintenance



1. Before disconnecting or repairing hoses, relieve all fluid pressure and shut off electrical power to proportioner. See proportioner operation manual.
2. Be sure fluid is cool before disconnecting hoses.

## Instructions for Replacing Individual A or B Hose

Before disconnecting hoses, relieve all fluid pressure and shut off electrical power to proportioner. See proportioner operation manual.

Disconnect electrical wire from connectors (12). Disconnect fluid hose and remove from bundle.

Install new hose in bundle, wrapping around other fluid hose and air hose. Connect fluid hoses, see page 13.

Connect electrical wire from new hose into connectors (12). Ensure that component A (ISO) wire is on + side of connector, component B (RES) wire is on - side. See page 13.

Wrap all connections with electrical tape, see page 22.



# Parts

## Using 261669 Fluid Temperature Sensor (JIC to JIC fittings)

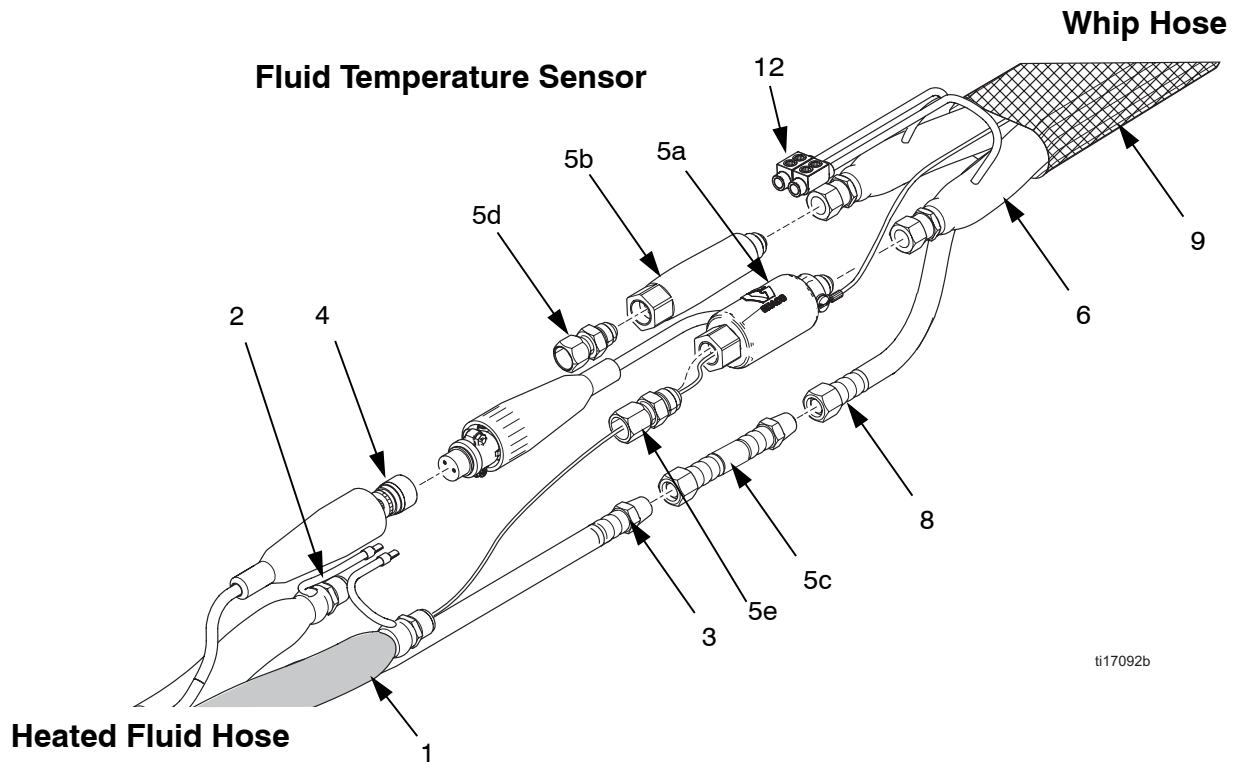

ti17092b

| Ref. Part | Description  | Qty | Ref. Part | Description  | Qty |
|-----------|--|-----|-----------|--|-----|
| 1         | HOSE, component A (ISO); see tables starting on page 4 | 1   | 6         | HOSE, whip; see <b>Whip Hoses</b> , page 3                             | 1   |
| 2         | HOSE, component B (RES); see tables starting on page 4 | 1   | 8         | 15B280 HOSE, whip, air; 10 ft (3 m)                                    | 1   |
| 3         | 15B295 HOSE, air; 50 ft (15.2 m)                       | 1   | 9         | SCUFF GUARD; included on some hoses, see <b>Accessories</b> on page 32 | 1   |
|           | 24F179 HOSE, air; 25 ft (7.6 m)                        | 1   | 12        | 261821 CONNECTOR, electrical; on main hose sections                    | 1   |
| 4         | 24J523 CABLE, FTS; 50 ft (15.2 m)                      | 1   | 13▲       | 15B679 LABEL, safety, English; not shown                               | 1   |
|           | 24J524 CABLE, FTS; 25 ft (7.6 m)                       | 1   | ▲         | 16M219 LABEL, safety, Spanish/French; not shown                        | 1   |
| 5         | 261669 KIT, FTS, coupler                               | 1   |           |  |     |
| 5a        | SENSOR, fluid temperature; -5 JIC                      | 1   |           |  |     |
| 5b        | FITTING, FTS coupler; -6 JIC                           | 1   |           |  |     |
| 5c        | 24V454 HOSE, air; 4.75 in. (120.65 mm)                 | 1   |           |  |     |
| 5d        | 127596 FITTING, swivel; -6 JIC x -6 JIC, mxf           | 1   |           |  |     |
| 5e        | 127597 FITTING, swivel; -5 JIC x -5 JIC, mxf           | 1   |           |  |     |

▲ Replacement Danger and Warning labels, tags, and cards are available at no cost.

## Using 24M943 Fluid Temperature Sensor (NPT to NPT fittings)

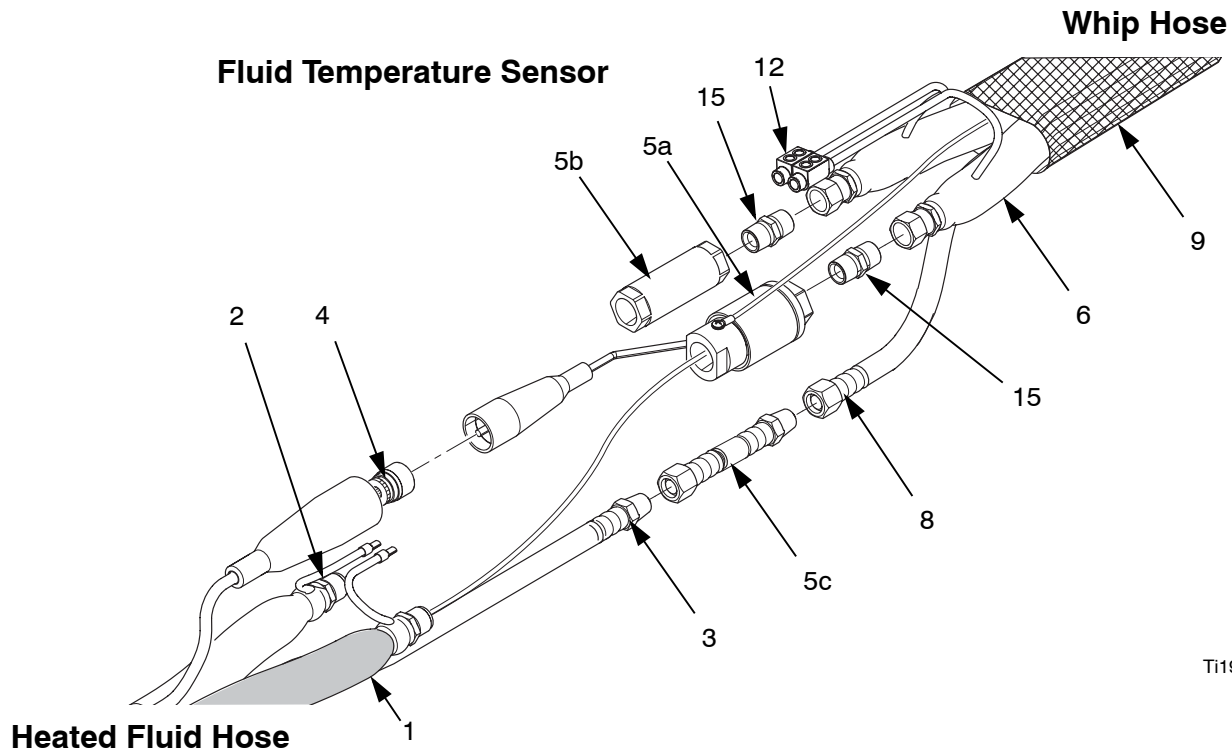

Ti19091b

| Ref. Part | Description  | Qty |
|-----------|--|-----|
| 1         | HOSE, component A (ISO); see tables starting on page 4                 | 1   |
| 2         | HOSE, component B (RES); see tables starting on page 4                 | 1   |
| 3         | 15B295 HOSE, air; 50 ft (15.2 m)                                       | 1   |
|           | 24F179 HOSE, air; 25 ft (7.6 m)  | 1   |
| 4         | 24J523 CABLE, FTS; 50 ft (15.2 m)                                      | 1   |
|           | 24J524 CABLE, FTS; 25 ft (7.6 m)                                       | 1   |
| 5         | 24M943 KIT, FTS, coupler   | 1   |
| 5a        | SENSOR, fluid temperature; 1/2 npt                                     | 1   |
| 5b        | FITTING, FTS coupler; (1/2 npt(f))                                     | 1   |
| 5c        | HOSE, air; 3.75 in. (95.3 mm)  | -   |
| 6         | HOSE, whip; see <b>Whip Hoses</b> , page 3                             | 1   |
| 8         | 15B280 HOSE, whip, air; 10 ft (3 m)                                    | 1   |
| 9         | SCUFF GUARD; included on some hoses; see <b>Accessories</b> on page 32 | 1   |
| 12        | 261821 CONNECTOR, electrical; on main hose sections                    | 1   |
| 13▲       | 15B679 LABEL, safety, English; not shown                               | 1   |
|           | ▲ 16M219 LABEL, safety, Spanish/French; not shown                      | 1   |
| 15★       | CONNECTOR, manifold  | 4   |

▲ *Replacement Danger and Warning labels, tags, and cards are available at no cost.*

★ Not included. Order connector fittings that connect to the A and B component hoses. See **Adapter Fittings**, page 3.

# Using 24K207 RTD 2-Component Hose Fluid Temperature Sensor (JIC to JIC fittings)

## Fluid Temperature Sensor

## Whip Hose

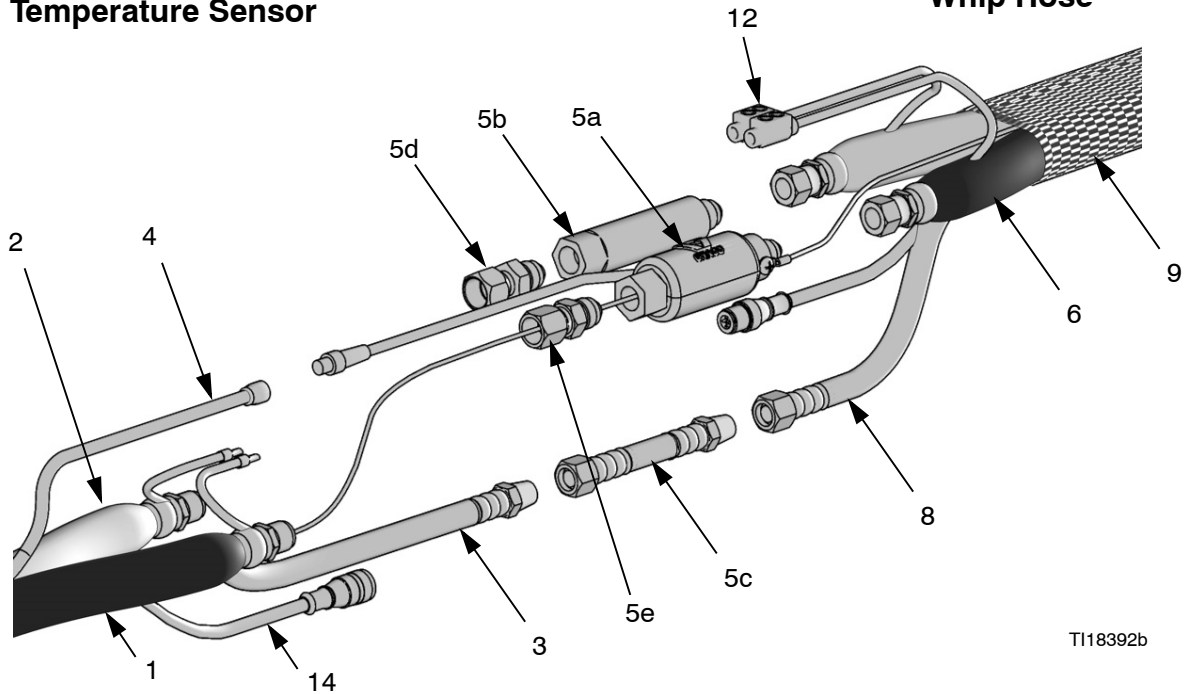

T118392b

## Heated Fluid Hose

| Ref. Part | Description  | Qty | Ref. Part | Description  | Qty |
|-----------|--|-----|-----------|--|-----|
| 1         | HOSE, component A (ISO); see tables starting on page 4 | 1   | 6         | HOSE, whip; see <b>Whip Hoses</b> , page 3                             | 1   |
| 2         | HOSE, component B (RES); see tables starting on page 4 | 1   | 8         | 15B280 HOSE, whip, air; 10 ft (3 m)                                    | 1   |
| 3         | 15B295 HOSE, air; 50 ft (15.2 m)                       | 1   | 9         | SCUFF GUARD; included on some hoses, see <b>Accessories</b> on page 32 | 1   |
| 4         | 24N450 CABLE, RTD; 50 ft (15.2 m)                      | 1   | 12        | 261821 CONNECTOR, electrical; on main hose sections                    | 1   |
| 5         | 24K207 KIT, FTS, coupler                               | 1   | 13▲       | 15B679 LABEL, safety, English; not shown                               | 1   |
| 5a        | SENSOR, FTS-RTD  | 1   | ▲ 16M219  | LABEL, safety, Spanish/French; not shown                               | 1   |
| 5b        | COUPLER  | 1   | 14*       | 24N449 CABLE, CAN; 50 ft (15.2 m)                                      | 1   |
| 5c        | 24V454 HOSE, air; 4.75 in. (120.65 mm)                 | 1   |           |  |     |
| 5d        | 127596 FITTING, swivel; -6 JIC x -6 JIC, mxf           | 1   |           |  |     |
| 5e        | 127597 FITTING, swivel; -5 JIC x -5 JIC, mxf           | 1   |           |  |     |

▲ Replacement Danger and Warning labels, tags, and cards are available at no cost.

\* Included only in hoses with CAN cable. See **RTD 2-Component Hose (for use with GCA Controlled Reactors)**, page 4.

# Using 24M944 RTD 2-Component Hose Fluid Temperature Sensor (NPT to NPT fittings)

## Fluid Temperature Sensor

## Whip Hose

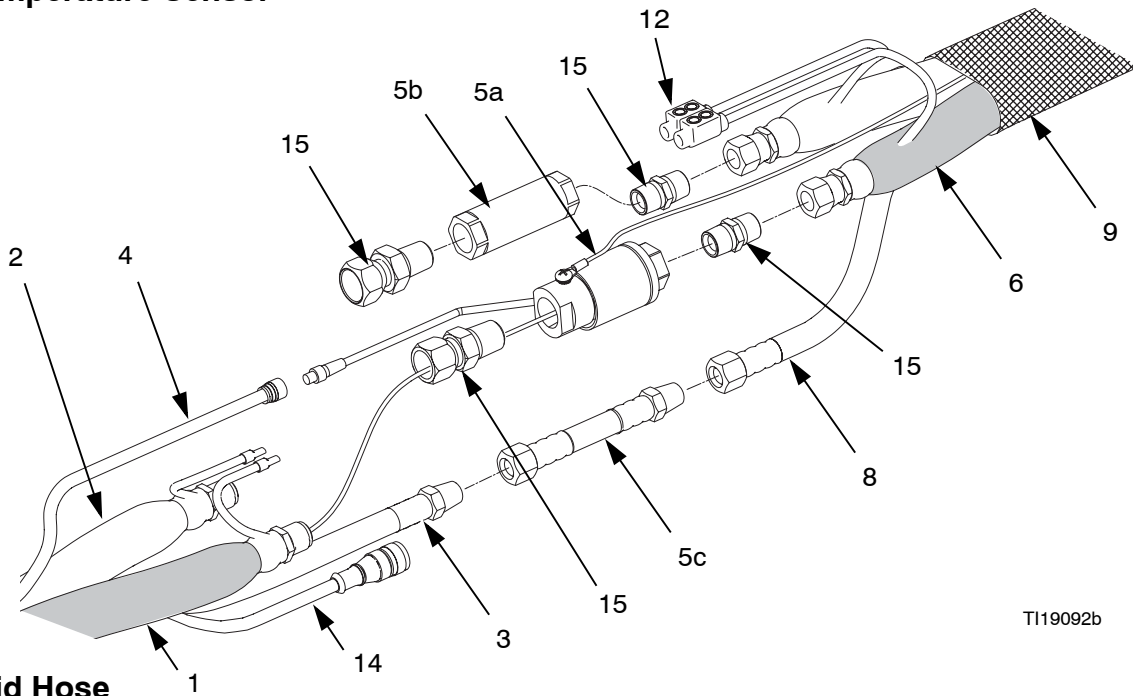

## Heated Fluid Hose

| Ref. Part | Description  | Qty | Ref. Part | Description  | Qty |
|-----------|--|-----|-----------|--|-----|
| 1         | HOSE, component A (ISO); see tables starting on page 4 | 1   | 8         | 15B280 HOSE, whip, air; 10 ft (3 m)                                    | 1   |
| 2         | HOSE, component B (RES); see tables starting on page 4 | 1   | 9         | SCUFF GUARD; included on some hoses, see <b>Accessories</b> on page 32 | 1   |
| 3         | 15B295 HOSE, air; 50 ft (15.2 m)                       | 1   | 12        | 261821 CONNECTOR, electrical; on main hose sections                    | 1   |
| 4         | 24N450 CABLE, RTD; 50 ft (15.2 m)                      | 1   | 13▲       | 15B679 LABEL, safety, English; not shown                               | 1   |
| 5         | 24M944 KIT, FTS, coupler                               | 1   | ▲ 16M219  | LABEL, safety, Spanish/French; not shown                               | 1   |
| 5a        | SENSOR, FTS-RTD  | 1   | 14*       | 24N449 CABLE, CAN; 50 ft (15.2 m)                                      | 1   |
| 5b        | COUPLER  | 1   | 15★       | CONNECTOR, manifold  | 4   |
| 5c        | <b>HOSE, air; 3.75 in. (95.3 mm)</b>                   | -   |           |  |     |
| 6         | HOSE, whip; see <b>Whip Hoses</b> , page 3             | 1   |           |  |     |

▲ Replacement Danger and Warning labels, tags, and cards are available at no cost.

\* Included only in hoses with CAN cable. See **RTD 2-Component Hose (for use with GCA Controlled Reactors)**, page 4.

★ Not included. Order connector fittings that connect to the A and B component hoses. See **Adapter Fittings**, page 3.

# Using 261670 Fluid Temperature Sensor (JIC to NPT fittings)

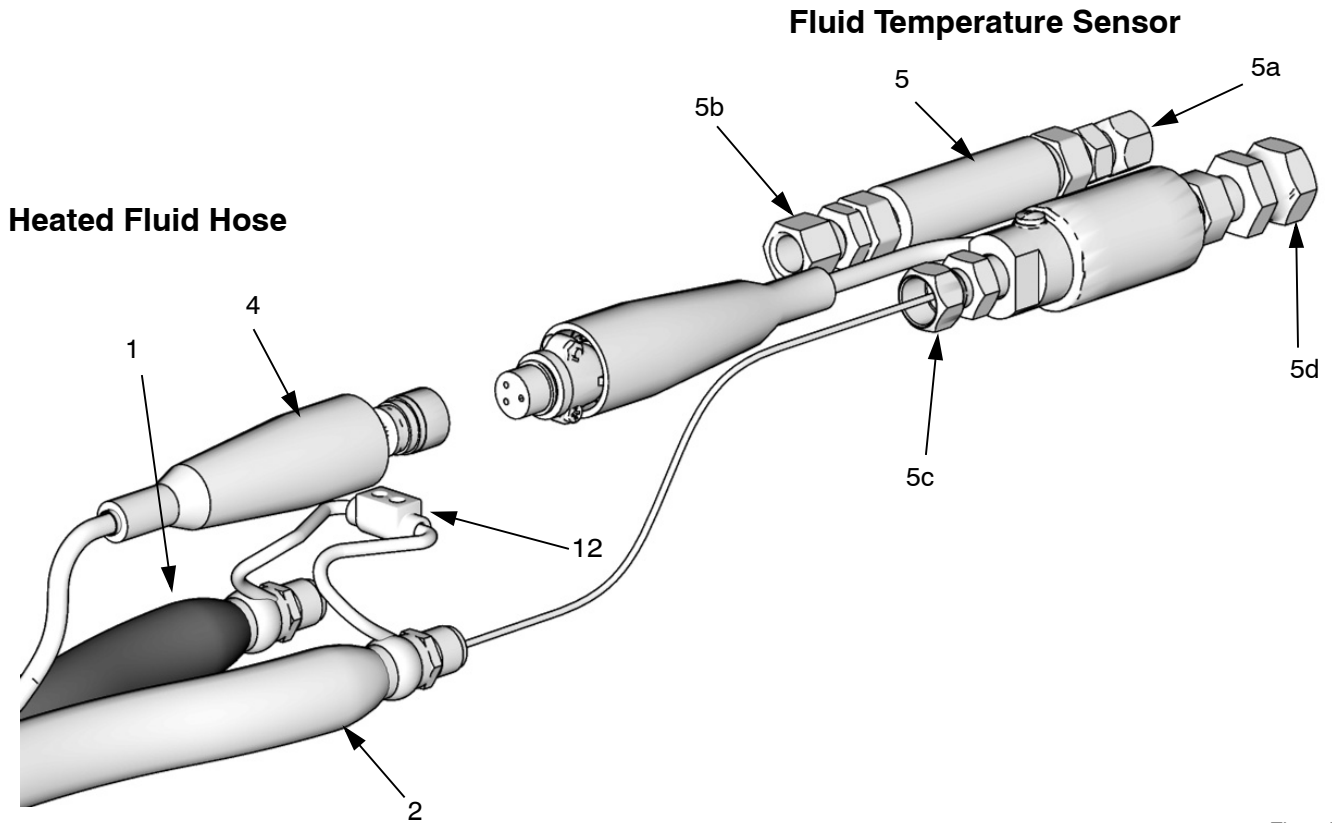

TI2684E

| Ref. | Part   | Description  | Qty | Ref.   | Part     | Description                                  | Qty |
|------|--------|--|-----|--|----------|--|-----|
| 1    |        | HOSE, component A (ISO); see tables starting on page 4 | 1   | 5c   | 117506   | . SWIVEL; 1/4 npt(m) x -6 JIC (f)            | 1   |
| 2    |        | HOSE, component B (RES); see tables starting on page 4 | 1   | 5d   | 157705   | . SWIVEL; 1/4 npt(m) x 3/8 npsm              | 1   |
| 4    | 24J523 | CABLE, FTS; 50 ft (15.2 m)                             | 1   | 12   | 261821   | CONNECTOR, electrical; on main hose sections | 1   |
|      | 24J524 | CABLE, FTS; 25 ft (7.6 m)                              | 1   | 13▲  | 15B679   | LABEL, safety, English; not shown            | 1   |
| 5    | 261670 | FLUID TEMPERATURE SENSOR; includes items 5a-5d         | 1   |  | ▲ 16M219 | LABEL, safety, French/Spanish; not shown     | 1   |
| 5a   | 156823 | . SWIVEL; 1/4 npt (m x 1/4 npsm                        | 1   | ▲ Replacement Danger and Warning labels, tags, and cards are available at no cost. |          |  |     |
| 5b   | 117595 | . SWIVEL; 1/4 npt(m) x -5 JIC (f)                      | 1   |  |          |  |     |

## 15F144 Hose Wire Jumper

Use the 15F144 Hose Wire Jumper to heat only the major volume hose, in a wide ratio system.

To build one complete 50 ft single side heated hose bundle, order the following parts:

| Ref. | Part             | Description  | Qty      |
|------|------------------|--|----------|
| 100  | 15F144           | JUMPER, hose wire  | 1        |
| 101  |                  | HOSE, resin, heated; 50 ft (15.2 m) minimum; see tables starting on page 4 | 1        |
| 102  | 24J523           | CABLE, FTS   | 1        |
| 104  | 261670           | FLUID TEMPERATURE SENSOR; see page 25                                      | 1        |
| 105  | purchase locally | HOSE, hardener, unheated; 50 ft (15.2 m) minimum; customer supplied        | 1        |
| 106  | purchase locally | CONNECTORS, fluid; as required to complete assembly; not shown             | as req'd |

Install as follows:



This hose must be used with an FTS and cable to provide grounding.

1. Wrap hose wire jumper (100) around resin hose (101) in a spiral fashion.
2. Connect resin hose wire (101a) to other side of Power-Lock connector (100a); see page 13.
3. Wrap FTS cable (102) around resin hose (101) in a spiral fashion.
4. Twist hoses (101 and 105) together to provide strain relief.
5. Repeat steps 1-4 for each length of hose (101). Connect hoses, electrical connectors, and cables; see **Connect Heated Hoses**, page 13.
6. Install one -Lock connector (100a) between wires; see page 13.
7. **Connect FTS with a Non-Heated Whip Hose or Remote Mix Manifold**, page 20.

8. Install whip hose and gun. Ensure that gun is grounded.
9. Connect hoses to proportioner.
10. Insulate and protect hoses. See **Protective Covering**, page 22.

 Some previous models include transformers with tap settings.

Set transformer wire taps, using the following table. Transformer tap wire connections vary depending on length of heated hose. See proportioner operation manual for further information. Verify that tap wire connections are correct.

| Single Side Heated Hose Length, ft (m) | Tap Terminal Label (ft) |
|--|-------------------------|
| 50 (15.2)                              | 50                      |
| 100 (30.5)                             | 50                      |
| 150 (45.7)                             | 100                     |
| 200 (61.0)                             | 100                     |
| 250 (76.2)                             | 150                     |
| 300 (91.5)                             | 150                     |
| 350 (106.8)                            | 200                     |
| 400 (122.0)                            | 200                     |

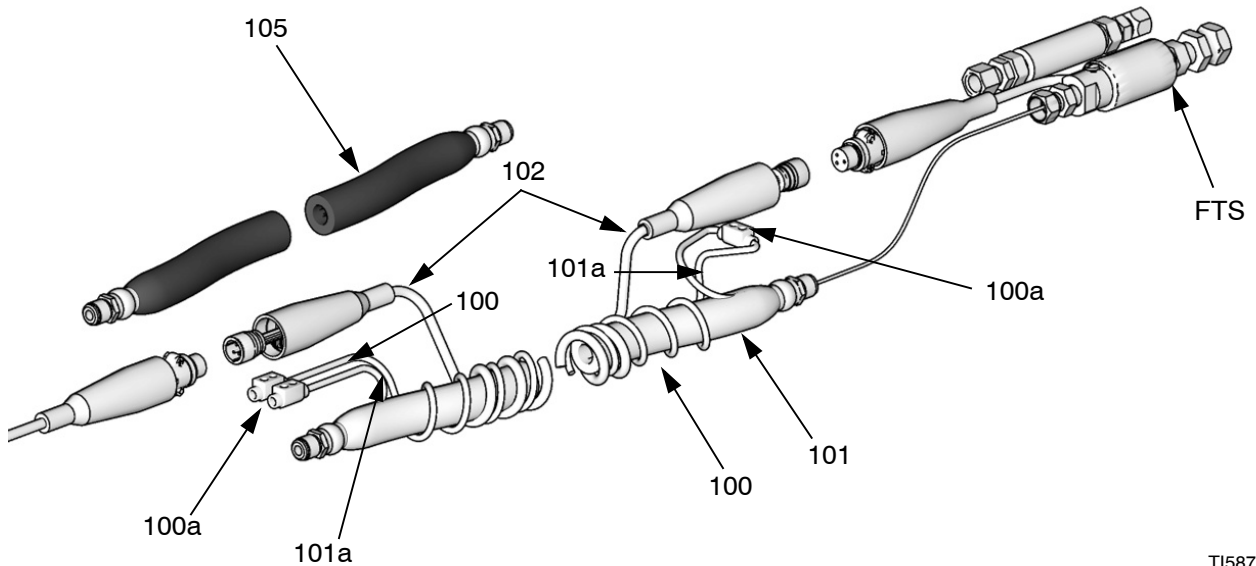

TI5872D

# Accessories

## Scuff Guard

Use to keep hose clean and protect it from damage.

| Part   | Description  |
|--------|--|
| 246077 | 7 ft (2.1 m) braided polyester mesh. For whip hose. Fold back over itself for easy installation. |
| 246078 | 50 ft (15.2 m) braided polyester mesh. Fold back over itself for easy installation.              |
| 246805 | 25 ft (7.6 m) braided polyester mesh. Fold back over itself for easy installation.               |
| 246456 | 50 ft (15.2 m) polyethylene bag. Inflate with air for easy installation.                         |
| 24T243 | 8 ft (2.4 m) Xtreme-Wrap abrasion-resistant woven nylon sleeve for whip hose                     |
| 24T244 | 55 ft (16.8 m) Xtreme-Wrap abrasion-resistant woven nylon sleeve                                 |



# Technical Data

| <b>Power-Lock Heated Hose</b>                                   |  |                 |
|---|--|-----------------|
|   | <b>US</b>  | <b>Metric</b>   |
| Maximum Air Working Pressure                                    | 130 psi  | 0.9 MPa, 9 bar  |
| Maximum Fluid Operating Temperature                             | 180°F  | 82°C            |
| Wetted Parts  | Nylon, Zinc-Plated Carbon Steel, 303 Stainless Steel |                 |
| <b>Total Heating Load (2 Hoses)</b>                             |  |                 |
| 1/4 in. diameter:   | 11 watts/foot  | 36 watts/meter  |
| 3/8 in. diameter:   | 13 watts/foot  | 43 watts/meter  |
| 1/2 in. diameter:   | 15 watts/foot  | 49 watts/meter  |
| <b>Whip Hose Maximum Fluid Working Pressure</b>                 |  |                 |
| 246050*   | 2000 psi   | 14 MPa, 138 bar |
| 246055*   | 3500 psi   | 24 MPa, 241 bar |
| 246056  | 3500 psi   | 24 MPa, 241 bar |
| 249586  | 2000 psi   | 14 MPa, 138 bar |
| 256407  | 2000 psi   | 14 MPa, 138 bar |
| 256626  | 3500 psi   | 24 MPa, 241 bar |
| 258701  | 5000 psi   | 35 MPa, 345 bar |
| 261686  | 3500 psi   | 24 MPa, 241 bar |
| <b>Standard 2 Component Hose Maximum Fluid Working Pressure</b> |  |                 |
| 246045  | 2000 psi   | 14 MPa, 138 bar |
| 246046  | 2000 psi   | 14 MPa, 138 bar |
| 246047  | 2000 psi   | 14 MPa, 138 bar |
| 246048  | 2000 psi   | 14 MPa, 138 bar |
| 246049  | 2000 psi   | 14 MPa, 138 bar |
| 246052  | 3500 psi   | 24 MPa, 241 bar |
| 246053  | 3500 psi   | 24 MPa, 241 bar |
| 246054  | 3500 psi   | 24 MPa, 241 bar |
| 246074  | 2000 psi   | 14 MPa, 138 bar |
| 246075  | 2000 psi   | 14 MPa, 138 bar |
| 246076  | 2000 psi   | 14 MPa, 138 bar |
| 246678  | 2000 psi   | 14 MPa, 138 bar |
| 246679  | 3500 psi   | 24 MPa, 241 bar |
| 249587  | 2000 psi   | 14 MPa, 138 bar |
| 249588  | 3500 psi   | 24 MPa, 241 bar |
| 256548  | 3500 psi   | 24 MPa, 241 bar |
| 256549  | 2000 psi   | 14 MPa, 138 bar |
| 261328  | 2000 psi   | 14 MPa, 138 bar |
| 261332  | 5000 psi   | 35 MPa, 345 bar |
| 261335  | 3500 psi   | 24 MPa, 241 bar |
| 262203  | 5000 psi   | 35 MPa, 345 bar |
| 24Y549*   | 2000 psi   | 14 MPa, 138 bar |
| 24Y678*   | 2000 psi   | 14 MPa, 138 bar |
| 24Y679*   | 3500 psi   | 24 MPa, 241 bar |

| <b>Power-Lock Heated Hose</b>   |           |                 |
|---|-----------|-----------------|
|   | <b>US</b> | <b>Metric</b>   |
| <b>RTD 2 Component Hose (For GCA Reactors) Maximum Fluid Working Pressure</b> |           |                 |
| 24K240  | 2000 psi  | 14 MPa, 138 bar |
| 24K241  | 3500 psi  | 24 MPa, 241 bar |
| 24K394  | 2000 psi  | 14 MPa, 138 bar |
| 24K395  | 3500 psi  | 24 MPa, 241 bar |
| 24N000  | 2000 psi  | 14 MPa, 138 bar |
| 24N001  | 2000 psi  | 14 MPa, 138 bar |
| 24N002  | 3500 psi  | 24 MPa, 241 bar |
| 24N003  | 3500 psi  | 24 MPa, 241 bar |
| 24T839  | 2000 psi  | 14 MPa, 138 bar |
| 24U743  | 3500 psi  | 24 MPa, 241 bar |
| 24Y240*   | 2000 psi  | 14 MPa, 138 bar |
| 24Y241*   | 3500 psi  | 24 MPa, 241 bar |
| 24Y394*   | 2000 psi  | 14 MPa, 138 bar |
| 24Y395*   | 3500 psi  | 24 MPa, 241 bar |
| <b>Airless 2 Component Hose Maximum Fluid Working Pressure</b>                |           |                 |
| 248907  | 5000 psi  | 35 MPa, 345 bar |
| 248908  | 5000 psi  | 35 MPa, 345 bar |
| 262727  | 5000 psi  | 35 MPa, 345 bar |
| 262728  | 5000 psi  | 35 MPa, 345 bar |
| 262730  | 5000 psi  | 35 MPa, 345 bar |
| <b>Custom Application 2 Component Hose Maximum Fluid Working Pressure</b>     |           |                 |
| 247164  | 3500 psi  | 24 MPa, 241 bar |
| 255089  | 2000 psi  | 14 MPa, 138 bar |
| 261329  | 2000 psi  | 14 MPa, 138 bar |
| 261334  | 3500 psi  | 24 MPa, 241 bar |
| 261336  | 3500 psi  | 24 MPa, 241 bar |
| 261337  | 3500 psi  | 24 MPa, 241 bar |
| <b>FTS Maximum Fluid Working Pressure</b>                                     |           |                 |
| 261669  | 5000 psi  | 35 MPa, 345 bar |
| 261670  | 5000 psi  | 35 MPa, 345 bar |
| 24M943  | 7250 psi  | 50 MPa, 500 bar |
| <b>FTS (For GCA Systems) Maximum Fluid Working Pressure</b>                   |           |                 |
| 24K207  | 5000 psi  | 35 MPa, 345 bar |
| 24M944  | 7250 psi  | 50 MPa, 500 bar |

\* These models include the Xtreme-Wrap Scuff Guard.



A series of 25 horizontal lines spanning the width of the page, providing a template for technical data entry.

# Graco Standard Warranty

Graco warrants all equipment referenced in this document which is manufactured by Graco and bearing its name to be free from defects in material and workmanship on the date of sale to the original purchaser for use. With the exception of any special, extended, or limited warranty published by Graco, Graco will, for a period of twelve months from the date of sale, repair or replace any part of the equipment determined by Graco to be defective. This warranty applies only when the equipment is installed, operated and maintained in accordance with Graco's written recommendations.

This warranty does not cover, and Graco shall not be liable for general wear and tear, or any malfunction, damage or wear caused by faulty installation, misapplication, abrasion, corrosion, inadequate or improper maintenance, negligence, accident, tampering, or substitution of non-Graco component parts. Nor shall Graco be liable for malfunction, damage or wear caused by the incompatibility of Graco equipment with structures, accessories, equipment or materials not supplied by Graco, or the improper design, manufacture, installation, operation or maintenance of structures, accessories, equipment or materials not supplied by Graco.

This warranty is conditioned upon the prepaid return of the equipment claimed to be defective to an authorized Graco distributor for verification of the claimed defect. If the claimed defect is verified, Graco will repair or replace free of charge any defective parts. The equipment will be returned to the original purchaser transportation prepaid. If inspection of the equipment does not disclose any defect in material or workmanship, repairs will be made at a reasonable charge, which charges may include the costs of parts, labor, and transportation.

**THIS WARRANTY IS EXCLUSIVE, AND IS IN LIEU OF ANY OTHER WARRANTIES, EXPRESS OR IMPLIED, INCLUDING BUT NOT LIMITED TO WARRANTY OF MERCHANTABILITY OR WARRANTY OF FITNESS FOR A PARTICULAR PURPOSE.**

Graco's sole obligation and buyer's sole remedy for any breach of warranty shall be as set forth above. The buyer agrees that no other remedy (including, but not limited to, incidental or consequential damages for lost profits, lost sales, injury to person or property, or any other incidental or consequential loss) shall be available. Any action for breach of warranty must be brought within two (2) years of the date of sale.

**GRACO MAKES NO WARRANTY, AND DISCLAIMS ALL IMPLIED WARRANTIES OF MERCHANTABILITY AND FITNESS FOR A PARTICULAR PURPOSE, IN CONNECTION WITH ACCESSORIES, EQUIPMENT, MATERIALS OR COMPONENTS SOLD BUT NOT MANUFACTURED BY GRACO.** These items sold, but not manufactured by Graco (such as electric motors, switches, hose, etc.), are subject to the warranty, if any, of their manufacturer. Graco will provide purchaser with reasonable assistance in making any claim for breach of these warranties.

In no event will Graco be liable for indirect, incidental, special or consequential damages resulting from Graco supplying equipment hereunder, or the furnishing, performance, or use of any products or other goods sold hereto, whether due to a breach of contract, breach of warranty, the negligence of Graco, or otherwise.

## **FOR GRACO CANADA CUSTOMERS**

The Parties acknowledge that they have required that the present document, as well as all documents, notices and legal proceedings entered into, given or instituted pursuant hereto or relating directly or indirectly hereto, be drawn up in English. Les parties reconnaissent avoir convenu que la rédaction du présente document sera en Anglais, ainsi que tous documents, avis et procédures judiciaires exécutés, donnés ou intentés, à la suite de ou en rapport, directement ou indirectement, avec les procédures concernées.

# Graco Information

For the latest information about Graco products, visit [www.graco.com](http://www.graco.com).

**TO PLACE AN ORDER**, contact your Graco distributor, or call this number to identify the distributor closest to you: **1-800-328-0211 Toll Free**  
**612-623-6921**  
**612-378-3505 Fax**

*All written and visual data contained in this document reflects the latest product information available at the time of publication. Graco reserves the right to make changes at any time without notice.*

For patent information, see [www.graco.com/patents](http://www.graco.com/patents).

Original instructions. This manual contains English. MM 309572

**Graco Headquarters:** Minneapolis

**International Offices:** Belgium, China, Japan, Korea

**GRACO INC. AND SUBSIDIARIES • P.O. BOX 1441 • MINNEAPOLIS MN 55440-1441 • USA**

Copyright 2002, Graco Inc. All Graco manufacturing locations are registered to ISO 9001.

[www.graco.com](http://www.graco.com)

Download from [www.graco.com](http://www.graco.com) Revision 2AR, May 2014

## Free Manuals Download Website

<http://myh66.com>

<http://usermanuals.us>

<http://www.somanuals.com>

<http://www.4manuals.cc>

<http://www.manual-lib.com>

<http://www.404manual.com>

<http://www.luxmanual.com>

<http://aubethermostatmanual.com>

Golf course search by state

<http://golfingnear.com>

Email search by domain

<http://emailbydomain.com>

Auto manuals search

<http://auto.somanuals.com>

TV manuals search

<http://tv.somanuals.com>