

iHome®

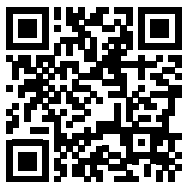

iBN97

***NFC Bluetooth Wireless
FM Clock Radio
with USB Charging***



instruction manual

Download from [Www.Somanuals.com](http://www.Somanuals.com). All Manuals Search And Download.

Introduction

Thank you for purchasing the iHome iBN97. This product is designed to provide high quality wireless sound for your iPad, iPhone, iPod, computer, or other Bluetooth audio device.

The dual alarms on this iHome clock radio can be set and used independently, so you can program each alarm to wake you up to a paired Bluetooth device, 4 separate alarm tones, the FM stereo radio, or a buzzer alarm. You may set each alarm for weekday, weekend, or everyday operation, and even adjust the alarm volume separately from your normal listening volume. And best of all, even if the power is out at your selected wake up time, the SureAlarm battery backup system will still activate the electronic buzzer alarm to get you up on time.

Along with the included Quick Bluetooth Connection Guide this instruction booklet explains the basic operation and care of the unit. Please read them carefully and keep for future reference.

This unit features NFC (near field communication) technology which allows you to wirelessly connect your NFC-enabled device to instantly 'pair and play'. See your device's user manual for details on how to interact with NFC devices.

If your Bluetooth device does not support NFC, you can pair it manually with this unit.

Maintenance

- Place the unit on a level surface away from sources of direct sunlight or excessive heat.
- Protect your furniture when placing your unit on a natural wood and lacquered finish. A cloth or other protective material should be placed between it and the furniture.
- Clean your unit with a soft cloth moistened only with mild soap and water. Stronger cleaning agents, such as benzene, thinner or similar materials, can damage the surface of the unit.

FCC Information

FCC Radiation Exposure Statement

This equipment complies with FCC RF radiation exposure limits set forth for an uncontrolled environment. This transmitter must not be co-located or operating in conjunction with any other antenna or transmitter.

This Device complies with RSS-210 of the IC Rules; Operation is subject to the following two conditions:

- (1) This device may not cause interference and
- (2) This device must accept any interference received, including interference that may cause undesired operation

This device complies with Part 15 of the FCC Rules, operation is subject to the following two conditions:
(1) This device may not cause harmful interference, and (2) this device must accept any interference received, including interference that may cause undesired operation.

- Warning: Changes or modifications to this unit not expressly approved by the party responsible for compliance could void the user's authority to operate the equipment.
- NOTE: This equipment has been tested and found to comply with the limits for a Class B digital device, pursuant to Part 15 of the FCC Rules.

These limits are designed to provide reasonable protection against harmful interference in a residential installation. This equipment generates, uses and can radiate radio frequency energy and, if not installed and used in accordance with the instructions, may cause harmful interference to radio communications.

However, there is no guarantee that interference will not occur in a particular installation. If this equipment does cause harmful interference to radio or television reception, which can be determined by turning the equipment off and on, the user is encouraged to try to correct the interference by one or more of the following measures:

- Reorient or relocate the receiving antenna.
- Increase the separation between the equipment and receiver.
- Connect the equipment into an outlet on a circuit different from that to which the receiver is connected.
- Consult the dealer or an experienced radio/TV technician for help.

This Class B digital apparatus complies with Canadian ICES-003.

Cet appareil numérique de la classe B est conforme à la norme NMB-003 du Canada.

Table of Contents

Meet Your iBN97	1-3
The Display/Setting Up the Unit	4
Setting the Clock/ FM Radio	5
Setting and Using FM Presets	6
Setting and Using the Alarm	7-8
Previewing and Turning Alarm Off/Setting Gentle Wake Timer	8
Snooze/Dimmer Button/Sleep and Nap Modes	9
Using Bluetooth: Pairing & Playing Your Device Using NFC	9
Pairing Your Device Using Standard Bluetooth.....	10
Playing Audio Via Bluetooth/Using the Speakerphone	11
Playing Audio Via Aux-in/Charging Devices via USB Port	12
Using FM Radio in Other Countries.....	13
Replacing and Installing Clock Backup Battery	14
Troubleshooting	15
Consumer Product Safety Guide	16-17
Warranty.....	18

iBN97

Included

- iBN97 system
- 100V-240V universal AC adaptor
- 3.5mm audio cable
- Backrest

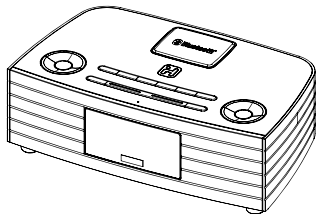

iBN97



power adaptor

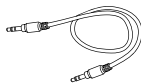

audio cable



backrest

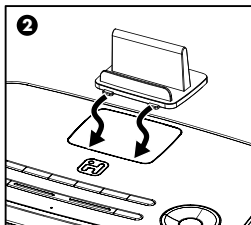
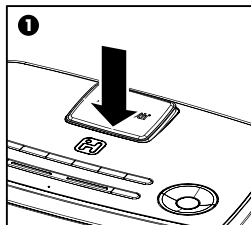

A removable backrest is included with the unit for best stability when resting a device on top of the unit in either portrait or landscape orientation.

1. To remove the flat rubberized rest, press down on the front of the rest and remove it.
2. To place the backrest, gently slide the front tabs into place.

Meet Your iBN97

Top

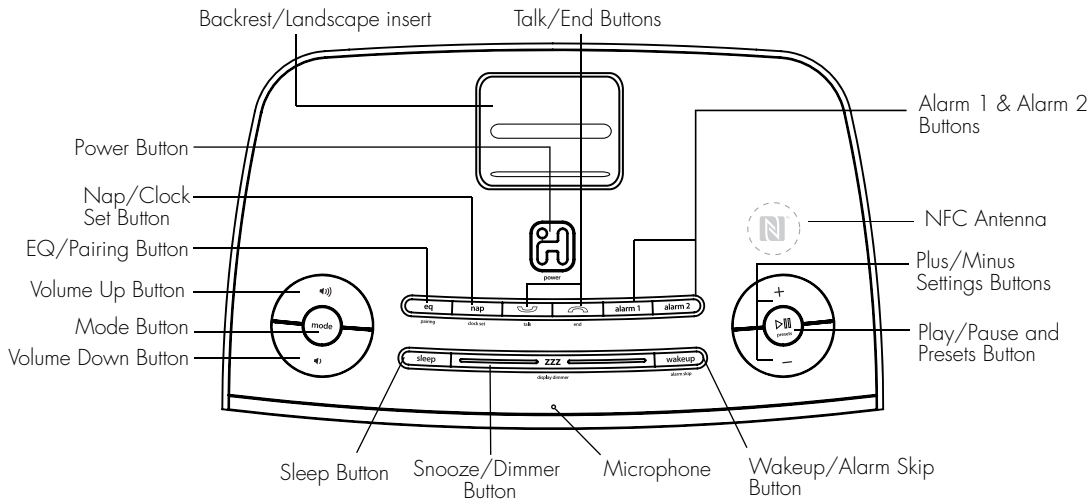

Meet Your iBN97

iBN97

Back

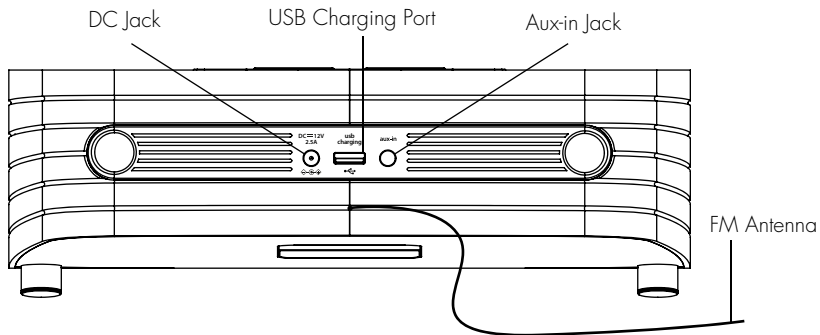

Bottom

Remove the pull tab before initial use to activate the SureAlarm battery backup system.

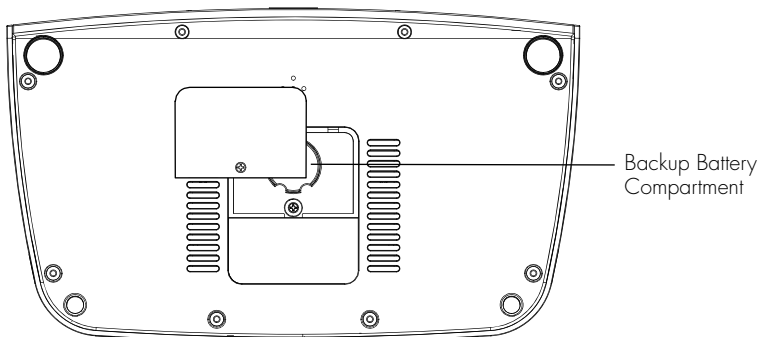

The Display

Using the iBN97

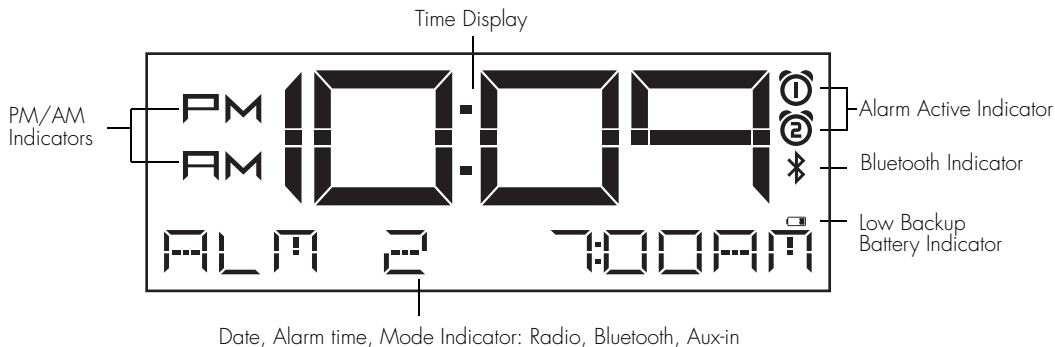

Setting Up the Unit

Connect the included AC adaptor to the DC jack located on the back of the unit and connect the other end to a working wall outlet.

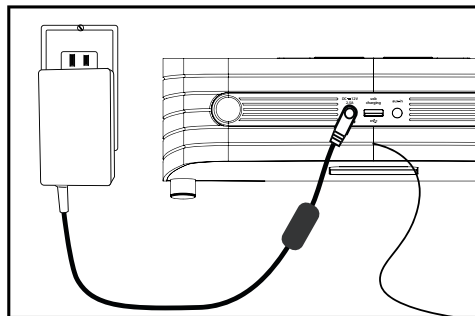

Using the iBN97

Setting the Clock

1. Press and hold the **Nap/Clock Set Button** for 2 seconds until the clock display flashes and unit beeps.



2. Press the **-** or **+** **Buttons** to adjust the clock to the current time (hold for rapid setting). Make sure you set the correct AM/PM time. The AM and PM indicators appear to the left of the display. To toggle the clock display between standard 12 hour time and 24 hour ("military") time display, press the **Alarm 1** or **Alarm 2 Button** during time setting.
3. Press the **Nap/Clock Set Button** again to confirm the time. The year will flash. Press the **-** or **+** **Buttons** to adjust the display to the current year (hold for rapid setting).
4. Press the **Nap/Clock Set Button** to confirm the year. The date will flash. Press the **-** or **+** **Buttons** to adjust the display to the current month and date (hold for rapid setting).
5. Press the **Nap/Clock Set Button** to confirm the time and exit clock setting mode. 2 beeps will confirm clock setting is complete.

FM Radio



1. Press and release the **Mode Button** as needed until the current FM radio station appears on the display.



2. Press the **-** or **+** **Buttons** to tune the radio to the desired station (hold for 2 seconds to search for the next clear station). Extend the FM antenna for best reception.





(Continued on next page)

FM Radio (cont'd)

3. Press the  or  **Buttons** to adjust the volume on the unit. To adjust the tone, press and release the **EQ Button** as needed to cycle to Treble, Bass or Balance, then press the **-** or **+** **Buttons** to adjust for best sound.
4. When you are through listening, press the  **Button** to turn the unit off.

Setting and Using FM Presets

The unit allows you to store up to 6 FM radio station presets

1. Press and release the **Mode Button** as needed until the current FM radio station appears on the display.
2. Press and release the  **/Presets Button** as needed until the preset number (P1- P6) you wish to sets is displayed, then *press and hold* the  **/Presets Button** to enter setting mode. One beep will sound.
3. Press the **-** or **+** **Buttons** to tune the radio to the desired station (hold to scan for the next clear station).
4. Press and release the  **/Presets Button** to confirm. 2 beeps will sound to confirm the preset has been assigned. Repeat steps 2 - 4 until you have set up to 6 preset stations.
5. To listen to a preset FM station at any time, press and release the **Mode Button** as needed to turn on FM radio mode then press and release the  **/Presets Button** as needed to cycle to the desired preset.

Setting and Using the Alarms

This unit has 2 separate alarms, each set the same way. Below we explain how to set alarm 1.

To set alarm 2, follow the same steps using the Alarm 2 Button.

1. Press and hold the **Alarm 1 Button** for 2 seconds until the alarm time flashes at the bottom of the display.
2. Press the **-** or **+** **Buttons** to adjust the display to the desired alarm time (hold for rapid setting). Make sure you set the correct AM/PM alarm time. The AM and PM indicators appear to the right of the alarm time display.
3. Press the **Alarm 1 Button** to confirm the alarm time setting. The alarm schedule display will flash.
4. Press the **-** or **+** **Buttons** to select the desired wake schedule: wake 7 days = every day of the week, wake weekdays = Monday through Friday, wake weekends = Saturday and Sunday.
5. Press the **Alarm 1 Button** to confirm the alarm schedule setting. The wake-to source display will flash.
6. Press the **-** or **+** **Buttons** to select the desired wake to alarm source: Bluetooth (BT), radio, tone or buzzer.

Wake to Bluetooth (BT): You will wake to the currently linked Bluetooth device. If no device is detected, the alarm will default to current Tone.

Wake to Radio: Press the **Alarm 1 Button** to confirm radio mode selection. Press the **▶▶ /Presets Button** to select an FM preset to wake to, or press the **-** or **+** **Buttons** to tune in a desired wake to station.

Wake to Tone: Press the **Alarm 1 Button** to confirm tone mode selection. Press the **-** or **+** **Buttons** to select one of four built in tones (Tone 1 - Tone 4).

Wake to Buzzer: You will wake to the buzzer alarm.

7. Press the **Alarm 1 Button** to confirm the wake-to source setting. The alarm volume display will flash.

(Continued on next page)

Setting and Using the Alarms (cont'd)

8. Press the **-** or **+** **Buttons** to adjust the alarm volume on the unit. Note that the alarm volume setting is stored separately from other volume settings.
9. Press the **Alarm 1 Button** to confirm the alarm settings and exit alarm setting mode. 2 beeps will confirm alarm setting is complete. The alarm icon will remain on the display, indicating the alarm is armed.

Previewing the Alarm and Turning the Alarm On/Off

1. Press and release the **Alarm Button** to view the current alarm time and wake-to source.
2. While preview is active (within 5 seconds), press and release the **Alarm Button** as needed to toggle the alarm ON and OFF, indicated by the alarm icon and a beep.

Alarm Skip

If Alarm 1 or Alarm 2 is active, press and release the **Wakeup/Alarm Skip Button** to skip the next pending alarm time. The display will show "ALM 1 SKIP" or "ALM 2 SKIP" until the specified alarm time is passed, then alarm skip is deactivated and the unit returns to normal alarm function.

Setting the Gentle Wake Timer

The unit has an adjustable Gentle Wake feature that gradually increases the volume of the alarm from 05 up to the set wake volume over time (the default duration is 15 seconds). You can adjust the duration of the gradual volume increase from 15, 30, 45, 60, 90, or 120 seconds or to OFF. Setting the duration to OFF will turn off Gentle Wake: the alarm will sound at the set alarm volume without a gradual volume increase.

1. To set the Gentle Wake duration, press and hold the **Wakeup/Alarm Skip Button** for 2 seconds until the Gentle Wake duration time flashes on the display.
2. Press the **-** or **+** **Button** to adjust the Gentle Wake time from 15 seconds up to 120 seconds (or off).
3. Press and release the **Wakeup/Alarm Skip Button**. 2 beeps will confirm Gentle Wake duration setting.

NOTE: The Gentle Wake duration does not affect the overall alarm cycle, which lasts for 1 hour.

Using the iBN97

Snooze/Dimmer Button

1. To program Snooze, press and hold the **Snooze/Dimmer Button** during normal operation (when no alarm is sounding).
2. Press the **-** or **+** **Buttons** to select the desired snooze time (between 1 and 29 minutes).
3. Press and release the **Snooze/Dimmer Button** to confirm Snooze setting.
4. While the alarm is sounding, press and release the **Snooze/Dimmer Button** to temporarily silence the alarm for the set duration (9 minutes is the default). Snooze can be used several times during alarm.
5. To adjust the brightness of the display, press and release the **Snooze/Dimmer Button** during normal operation (when no alarm is sounding) to cycle through the display brightness settings.

Sleep and Nap Modes



This unit allows you to sleep or nap to the current sound source.

1. To set Sleep time, press and release the **Sleep Button** as needed to cycle to the desired sleep duration:
120, 90, 60, 30 or 15 minutes or OFF (turns the unit off).
2. Press the **⏮** or **⏭** **Buttons** to adjust the sleep volume on the unit. Note that the sleep volume setting is stored separately from other volume settings.
3. To set Nap time, press and release the **Nap Button** as needed to cycle to the desired nap duration:
5, 10, 15, 20, 30, 45, 60, 90 or 120 minutes or OFF (turns the nap alarm off).

Using the iBN97

Using Bluetooth: Pairing and Playing Your Device Using **NFC**

This unit features wireless NFC pairing, which allows playing NFC-enabled devices to pair and play instantly. For pairing non-NFC devices, please see the following section "Pairing Your Device Using Standard Bluetooth".

1. Turn on your Bluetooth-enabled/NFC-enabled device and turn on Bluetooth and NFC capability as described in the device's user manual.
2. Place your NFC-enabled device in play mode.
3. Touch the NFC area of your playing device against the NFC antenna on top of the unit. The unit will turn on and enter automatic pairing mode. The Bluetooth icon will flash on the display, indicating pairing attempt. "iHome iBN97" should appear on your device's menu. Once paired with a device, the **Bluetooth** indicator on the iBN97 display will stop flashing then the Bluetooth icon will remain.
4. Use the controls on your device to play or pause audio and navigate tracks.
5. Press the  or  **Buttons** to adjust the volume on the unit. You can also adjust volume on your device.
6. When done listening, press the  **Button** to turn the unit OFF. Remember to turn off your audio device, too.



NOTE: To disconnect your device, simply touch it again on the NFC antenna on top of the unit. To pair a device manually, please see the following "Pairing Your Device Using Standard Bluetooth" section.

Using the iBN97

Pairing Your Device Using Standard Bluetooth

1. Turn on your Bluetooth-enabled device and turn on Bluetooth capability as described in the device's user manual.
2. Press the **⏻ Button** to turn the unit ON.
3. Press and release the **Mode Button** as needed until the Bluetooth indicator icon appears on the display.
4. Press and hold the **EQ/Pairing Button** on the top of the unit for 2 seconds to begin pairing the unit with your device. The Bluetooth icon will flash on the display, indicating pairing attempt. "iHome iBN97" should appear on your device's menu. If "Not Paired", "Not Connected" or similar message appears on your device, select "iHome iBN97" on the device to connect it. If your device asks for a password, enter **1234** on the keyboard of your device. If no device is paired within 1 minute, a tone will sound and the unit will revert to its previous mode. To retry pairing, turn the unit OFF then back ON, then follow steps 2 - 4 again.
5. Once paired with a device, the **Bluetooth** indicator on the display will stop flashing but the Bluetooth icon will remain. On some devices, you must then select "Use as Audio Device" or similar on the device's Bluetooth menu. Once paired, your device should link to the iBN97 whenever within range.

Pairing with a Different Device

When you power ON the speaker, it will automatically link with the previously paired Bluetooth device as long as that device is still within range (about 30 feet). To pair with a different device follow steps 1-4 above.

Playing Audio Via Bluetooth

1. Press and release the **Mode Button** as needed until the Bluetooth indicator icon appears on the display.
2. Press the **▶|| Play Pause Button** on the unit to play audio from your linked Bluetooth device.
3. Press the **-** or **+** **Buttons** on the unit to go to the previous or next track. (This function may be disabled on some devices).
4. Press the **◀** or **▶** **Buttons** to adjust the volume on the unit. To adjust the tone, press and release the **EQ Button** as needed to cycle to Treble, Bass or Balance, then press the **-** or **+** **Buttons** to adjust for best sound.
5. When done listening, press the **⏻ Button** to turn the unit off. Remember to turn off your audio device, too.

Using the Speakerphone

NOTE: The unit does NOT have to be powered on to receive a call. A Bluetooth phone must be linked.

1. When a call is received, playing music is muted to hear the ring tone. Press the green **☎ Talk Button** to answer the call (the calling number will appear on the display), or press the red **☎ End Button** to ignore it.
2. When the call is completed, press the **☎ End Button** to end the call and resume previous function.

Call waiting: Press the **☎ Talk Button** to put the current call on hold and answer a new one.

Press again to return to the previous call/toggle between calls.

Redial: Press the **☎ Talk Button** twice (2X) to dial the last called number.

Using the iBN97

Playing Audio via Aux-In

1. Connect one end of the included standard stereo 3.5mm audio cable into the aux-in jack on the back of the unit and the other end into the headphone or output jack of your audio device.
2. Press the **⏻ Button** on the unit to turn it on.
3. Press and release the **Mode Button** as needed until the AUX indicator icon appears on the display.
4. Press the **◀** or **▶** **Buttons** to adjust the volume on the unit.
5. When done listening, press the **⏻ Button** to turn the unit off. Remember to turn off your audio device, too.

Charging Devices via USB Port

1. Connect the standard size end of a USB cable (not included) to the USB Port on back of the unit and connect the other end to the charging port on your device.
2. Monitor the charging on your device. Some devices use a proprietary charging method and will not charge using the USB Port. If this happens, you must charge your device using the charger that came with it.

NOTE: unit must be plugged into working outlet to charge devices

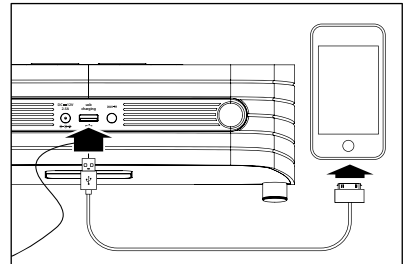

Using the iBN97

Using FM Radio in Other Countries

Different areas of the world use different FM frequency steps and ranges. By default, this unit is set to USA frequency steps. To use the radio outside the USA:

1. Make sure unit is OFF. Press and hold the **Mode Button** for 5 seconds until "USA" appears in the display.
2. Press and release **-** or **+** **Buttons** to cycle to your location: Europe, Japan, Australia, China or USA.
3. Press the **Mode Button** again to exit frequency setting mode.

Using the iBN97

Replacing and Installing Clock Backup Battery

Note: The CR2450 lithium battery is included in the unit. Please pull out the battery pull tab before you use the unit.

This model is equipped with a battery backup circuit that will maintain the time and alarm time settings in the event of a temporary power interruption. The battery backup circuit will also operate the buzzer alarm to wake you up at the selected wake up time even if the power is out. The battery backup circuit requires one CR2450 lithium battery, included.

When the backup battery is getting weak the Low Backup Battery Indicator will begin flashing in the display. When you see this flashing indicator you should replace the backup battery as soon as possible. Purchase a replacement CR2450 battery, available wherever batteries are sold, and follow steps 1 - 3 below to install the replacement battery.

To replace the backup battery:

IMPORTANT: When replacing the backup battery be sure to have the unit connected to the AC outlet to maintain all of your settings, otherwise it will be necessary to reset the time and alarm time after the battery is replaced.

1. Remove the battery cover located on the bottom of the unit and remove the exhausted CR2450 battery.
2. Insert a fresh CR2450 battery in the backup battery compartment with the "+" side facing up.
3. Replace the batter compartment cover. Confirm that the backup batter indicator is not flashing in the display.

Note: Make sure you dispose of the battery properly (see your local regulations).

Troubleshooting

Unit doesn't respond (no power)

- Check that all connections are correct and properly plugged in.
- Make sure your device is properly paired with the iBN97.
- Make sure the **Power** is ON.

Unit doesn't respond (locked up or frozen)

The unit may need to be reset. To do so, disconnect the unit from AC power and remove the backup battery. Let unit sit for 3-5 minutes. Re-install backup battery and reconnect to AC power.

Trouble pairing device/computer with iBN97

Bluetooth implementation varies depending on your device's hardware and operating system. Please see our website for updates on pairing.

- When you power ON the unit, it will automatically link with the last previously paired Bluetooth device if the device is still within range (about 30 feet). To pair with a different device you must turn off Bluetooth capability on the already paired device, or take it out of range.
- Make sure your device is working properly. Check your device's manual for details on Bluetooth pairing and linking.

For further information and to see the latest instructions, visit www.ihomeaudio.com/support

Consumer Product Safety Guide

IMPORTANT SAFETY INSTRUCTIONS

When used in the directed manner, this unit has been designed and manufactured to ensure your personal safety. However, improper use can result in potential electrical shock or fire hazards. Please read all safety and operating instructions carefully before installation and use, and keep these instructions handy for future reference. Take special note of all warnings listed in these instructions and on the unit.

1. **Water and Moisture** – The unit should not be used near water. For example: near a bathtub, washbowl, kitchen sink, laundry tub, swimming pool or in a wet basement.
2. **Ventilation** – The unit should be situated so that its location or position does not interfere with its proper ventilation. For example, it should not be situated on a bed, sofa, rug or similar surface that may block ventilation openings. Also, it should not be placed in a built-in installation, such as a bookcase or cabinet, which may impede the flow of air through the ventilation openings.
3. **Heat** – The unit should be situated away from heat sources such as radiators, heat registers, stoves or other appliances (including amplifiers) that produce heat.
4. **Power Sources** – The unit should be connected to a power supply only of the type described in the operating instructions or as marked on the appliance.
5. **Power-Cable Protection** – Power supply cables should be routed so that they are not likely to be walked on or pinched by items placed upon or against them. It is always best to have a clear area from where the cable exits the unit to where it is plugged into an AC socket.
6. **Cleaning** – The unit should be cleaned only using a warm damp cloth. Do not use solvents, etc.
7. **Objects and Liquid Entry** – Care should be taken so that objects do not fall and liquids are not spilled into any openings or vents located on the product.

8. **Attachments** – Do not use attachments not recommended by the product manufacturer.
9. **Lightning and Power Surge Protection** – Unplug the unit from the wall socket and disconnect the antenna or cable system during a lightning storm or when it is left unattended and unused for long periods of time. This will prevent damage to the product due to lightning and power-line surges.
10. **Overloading** – Do not overload wall sockets, extension cords, or integral convenience receptacles as this can result in a risk of fire or electric shock.
11. **Damage Requiring Service** – The unit should be serviced by qualified service personnel when:
 - A. the power supply cable or plug has been damaged.
 - B. objects have fallen into or liquid has been spilled into the enclosure.
 - C. the unit has been exposed to rain.
 - D. the unit has been dropped or the enclosure damaged.
 - E. the unit exhibits a marked change in performance or does not operate normally.
12. **Periods of Nonuse** – If the unit is to be left unused for an extended period of time, such as a month or longer, the power cable should be unplugged from the unit to prevent damage or corrosion.
13. **Service** – The user should not attempt to service the unit beyond those methods described in the user's operating instructions. Service methods not covered in the operating instructions should be referred to qualified service personnel.

Questions? Visit www.ihomeaudio.com
or call 1-800-288-2792 Toll Free

Limited 1 Year Warranty

iHome Products, a division of SDI Technologies Inc. (hereafter referred to as SDI), warrants this product to be free from defects in workmanship and materials, under normal use and conditions, for a period of one (1) year from the date of original purchase.

Should this product fail to function in a satisfactory manner, it is best to first return it to the store where it was originally purchased. Should this fail to resolve the matter and service still be required by reason of any defect or malfunction during the warranty period, SDI will repair or, at its discretion, replace this product without charge. This decision is subject to verification of the defect or malfunction upon delivery of this product to the Factory Service Center authorized by SDI Customer Service. The product must include proof of purchase, including date of purchase. An out-of-warranty fee for service will be charged for units that are received without proof of purchase.

Before returning this product for service, please first replace the batteries (if applicable) with fresh ones, as exhausted or defective batteries are the most common cause of problems encountered.

If service is still required:

1. Call SDI Customer Service at 1-800-288-2792 for Return Authorization and for the address of the Factory Service Center.
2. Remove the batteries (if applicable) and pack the unit in a well padded, heavy corrugated box. SDI is not responsible for damage that occurs during shipping to the Factory Service Center.
3. Enclose a photocopy of your sales receipt, credit card statement, or other proof of the date of purchase, if within the warranty period. Also include your name and address information, a brief description for why the unit is being returned, and the return authorization number. No unit can be processed without a return authorization number.
4. Write the return authorization number on the side of the shipping package and send the unit prepaid and insured to the Factory Service Center address authorized by SDI Customer Service.

Disclaimer of Warranty

NOTE: This warranty is valid only if the product is used for the purpose for which it was designed. It does not cover (i) products which have been damaged by negligence or willful actions, misuse or accident, or which have been modified or repaired by unauthorized persons; (ii) cracked or broken cabinets, or units damaged by excessive heat; (iii) damage to digital media players, CD's or tape cassettes (if applicable); (iv) the cost of shipping this product to the Factory Service Center and its return to the owner.

This warranty is valid only in the United States of America and does not extend to owners of the product other than to the original purchaser. In no event will SDI or any of its affiliates, contractors, resellers, their officers, directors, shareholders, members or agents be liable to you or any third party for any consequential or incidental damages, any lost profits, actual, exemplary or punitive damages. (Some states do not allow limitations on implied warranties or exclusion of consequential damages, so these restrictions may not apply to you.) This warranty gives you specific legal rights, and you may also have other rights which vary from state to state.

Your acknowledgement and agreement to fully and completely abide by the above mentioned disclaimer of warranty is contractually binding to you upon your transfer of currency (money order, cashier's check, or credit card) for purchase of your SDI product.

© 2013 SDI Technologies, Inc. All rights reserved
Questions? Visit www.ihomeaudio.com
or call 1-800-288-2792 Toll Free

Free Manuals Download Website

<http://myh66.com>

<http://usermanuals.us>

<http://www.somanuals.com>

<http://www.4manuals.cc>

<http://www.manual-lib.com>

<http://www.404manual.com>

<http://www.luxmanual.com>

<http://aubethermostatmanual.com>

Golf course search by state

<http://golfingnear.com>

Email search by domain

<http://emailbydomain.com>

Auto manuals search

<http://auto.somanuals.com>

TV manuals search

<http://tv.somanuals.com>