

Instructions for Installation and Use

HOB

CIB 644 C E
CIB 64 C. S
CIB644.1 CE
CIB 644 B E

GB

WARNING!

- **WARNING:** The appliance and its accessible parts become hot during use.
- Care should be taken to avoid touching heating elements.
- Children less than 8 years of age shall be kept away unless continuously supervised.
- This appliance can be used by children aged from 8 years and above and persons with reduced physical, sensory or mental capabilities or lack of experience and knowledge if they have been given supervision or instruction concerning use of the appliance in a safe way and understand the hazards involved. Children shall not play with the appliance. Cleaning and user maintenance shall not be made by children without supervision.
- **WARNING:** Unattended cooking on a hob with fat or oil can be dangerous and may result in fire.
- NEVER try to extinguish a fire with water, but switch off the appliance and then cover flame e.g. with a lid or a fire blanket.
- **WARNING:** Danger of fire: do not store items on the cooking surfaces.
- **WARNING:** If the surface in glass-ceramic is cracked, switch off the appliance to avoid the possibility of electric shock.
- Never use steam cleaners or pressure cleaners on the appliance.
- The appliance is not intended to be operated by means of an external timer or separate remote control system.
- Do not place metal objects (knives, spoons, pan lids, etc.) on the hob as they may become hot.
- After use, switch off the hob element by its control and do not rely on the pan detector.

English

GB

Operating Instructions

HOB

Contents

Operating Instructions,1
WARNING,2
Description of the appliance-Control Panel,3
Installation,3
Start-up and use,5
Precautions and tips,10
Care and maintenance,11
Technical description of the models,11

 **Hotpoint**

Please phone us on
08448 24 24 24
to activate your
guarantee

PLEASE PHONE US TO REGISTER YOUR APPLIANCE AND ACTIVATE YOUR PARTS GUARANTEE ON 08448 24 24 24

Description of the appliance

Control panel

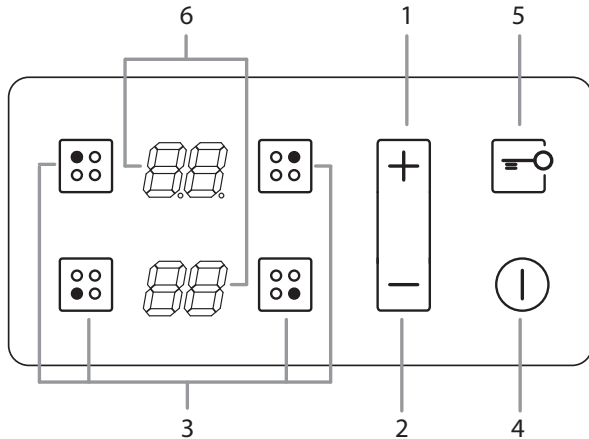

The control panel described in this manual is only a representative example: it may not exactly match the panel on your appliance.



When using the touch control panel:

- Do not use gloves
- Use a clean finger
- Touch the glass smoothly

- 1 **INCREASE POWER/ TIME** button - controls the power and time
- 2 **REDUCE POWER/ TIME** button controls the power and time.
- 3 **COOKING ZONE SELECTOR** button is used to select the desired cooking zone
- 4 **ON/OFF** button switches the appliance on and off.
- 5 **CONTROL PANEL LOCK** button prevents accidental changes to the hob settings and shows the control panel has been locked.
- 6 **HEATER DISPLAY** - shows the cooking zone selected, power level, preset time of cooking, booster function activated.

! For detailed information on the control panel functions refer to "Start-up and use" section.

! This product complies with the requirements of the latest European Directive on the limitation of power consumption of the standby mode. If no operations are carried out for a period of 2 minutes, after the residual heat indicator lights turn off and the fan stops (if present), the appliance automatically switches to the off mode. The appliance resumes the operating mode once the ON/OFF button is pressed.

! Depending on the number of heaters/cooking zones on the hob the COOKING ZONE SELECTOR BUTTONS may vary between  and 

Installation

! Before operating your new appliance please read this instruction booklet carefully. It contains important information concerning the safe operation, installation and maintenance of the appliance.

! Please keep these operating instructions for future reference. Pass them on to any new owners of the appliance.

Positioning

! Keep all packaging material out of the reach of children. It may present a choking or suffocation hazard (see Precautions and tips).

! The appliance must be installed by a qualified professional in accordance with the instructions provided. Incorrect installation may cause harm to people and animals or may damage property.

Built-in appliance

Use a suitable cabinet to ensure that the appliance functions properly.

- The supporting surface must be heat-resistant up to a temperature of approximately 100°C.
- If the appliance is to be installed above an oven, the oven must be equipped with a forced ventilation cooling system.
- Avoid installing the hob above a dishwasher: if this cannot be avoided, place a waterproof separation device between the two appliances.

Ventilation

To allow adequate ventilation and to avoid overheating of the surrounding surfaces the hob should be positioned as follows:

- At a minimum distance of 40 mm from the back panel or any other vertical surfaces.
- So that a minimum distance of 20 mm is maintained between the installation cavity and the cabinet underneath.
- Kitchen cabinets adjacent to the appliance and taller than the top of the hob must be at least 450 mm from the edge of the hob.

Fixing

The appliance must be installed on a perfectly level supporting surface. Any deformities caused by improper fixing could affect the features and operation of the hob. The thickness of the supporting surface should be taken into account when choosing the length of the screws for the fixing hooks:

- 3,5 mm thick: 9,5 mm screws

Installation of the safety washer

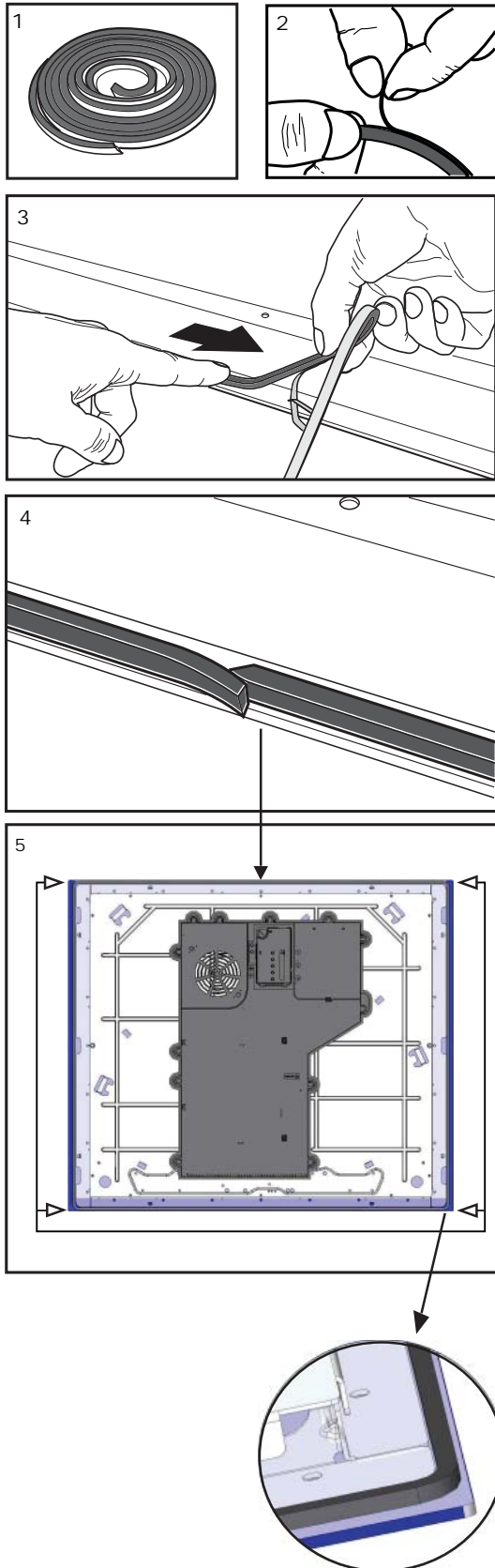

CABINET DIMENSIONS

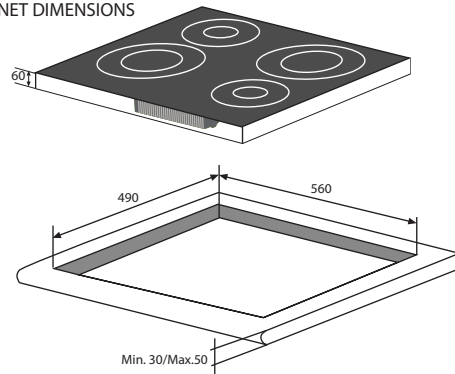

SAFETY DISTANCES WITH FURNITURE

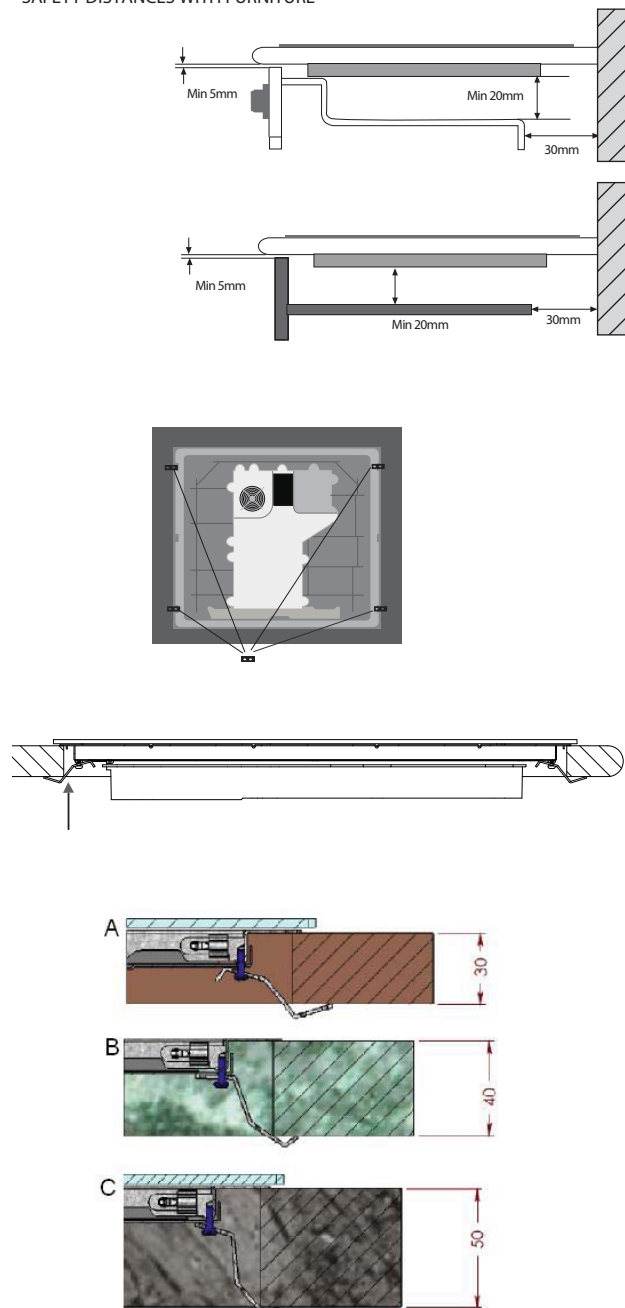

Fix the hob as follows:

1. Use short flat-bottomed screws to fix the 4 alignment springs in the holes provided at the central point of each side of the hob.
2. Place the hob in the cavity, make sure it is in a central position and push down on the whole perimeter until the hob is stuck to the supporting surface.

! The screws for the alignment springs must remain accessible.

! In order to adhere to safety standards, the appliance must not come into contact with electrical parts once it has been installed.

! All parts which ensure the safe operation of the appliance must not be removable without the aid of a tool.

Electrical connection

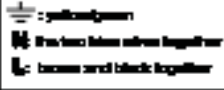

! The electrical connection for the hob and for any built-in oven must be carried out separately, both for safety purposes and to make extracting the oven easier.

Single-phase connection

Voltage and mains frequency	Electrical cable	Wire connection
230-240V 1+N ~ 50/60 Hz		 <ul style="list-style-type: none"> ⊕ : yellow/green N : the two blue wires together L : brown and black together

The hob is equipped with a pre-connected electricity supply cable, which is designed for single-phase connection. Connect the wires in accordance with the instructions given in the following table and diagrams:

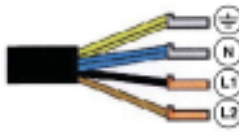
Other types of connection

Voltage and mains frequency	Electrical cable	Wire connection
400V - 2+N ~ 50/60 Hz 220-240V 3 ~ 50/60 Hz		 <ul style="list-style-type: none"> ⊕ : yellow/green N : the two blue wires together L1 : black L2 : brown

If the mains supply corresponds with one of the following:

Voltage and mains frequency

- 400V - 2+N ~ 50/60 Hz
- 220-240V 3 ~ 50/60 Hz

Separate the wires and connect them in accordance with the instructions given in the following table and diagrams:

Connecting the electricity supply cable to the mains

If the appliance is being connected directly to the electricity mains an omnipolar switch must be installed with a minimum opening of 3 mm between contacts.

! The installer must ensure that the correct electrical connection has been made and that it is fully compliant with safety regulations.

Start-up and use

Before connecting the appliance to the power supply, make sure that:

- The appliance is earthed and the plug is compliant with the law.
- The socket can withstand the maximum power of the appliance, which is indicated on the data plate located on the appliance itself.
- The voltage falls within the range of values indicated on the data plate.
- The socket is compatible with the plug of the appliance. If the socket is incompatible with the plug, ask an authorised technician to replace it. Do not use extension cords or multiple sockets.

! Once the appliance has been installed, the power supply cable and the electrical socket must be easily accessible.

! The cable must not be bent or compressed.

! The cable must be checked regularly and replaced by authorised technicians only.

! The manufacturer declines any liability should these safety measures not be observed.

! Do not remove or replace the power supply cable for any reason. Its removal or replacement will void the warranty and the CE marking. INDESIT does not assume liability for accidents or damage arising from replacement/removal of the original power supply cable. Replacement can only be accepted when carried out by personnel authorised by INDESIT and using an original spare part.

! The glue applied on the gaskets leaves traces of grease on the glass. Before using the appliance, we recommend you remove these with a special non-abrasive cleaning product. During the first few hours of use there may be a smell of rubber which will disappear very quickly.

! A few seconds after the hob is connected to the electricity supply, a buzzer will sound. The hob may now be switched on.

Types of noise during normal hob operation:

- Buzz: due to the vibration of the metallic parts that make up the induction element and the pot; it is generated by the electromagnetic field required for heating and increases as the power of the induction element increases.
- Soft whistle: heard when the pot placed on the heating zone is empty; the noise disappears once food or water is placed into the pot.
- Crackle: produced by the vibration of materials on the bottom of the pot due to the flow of parasitic currents caused by electromagnetic fields (induction); can be more or less intense depending on the material making up the bottom of the pot, and decreases as the pot dimensions increase.

- Loud whistle: heard when two induction elements of the same group function simultaneously at maximum power and/or when the booster function is set on the larger element while the other is auto-adjusted. Noise is reduced by decreasing the power level of the auto-adjusted induction element; pot bottom layers made of different kinds of materials are among the main causes of this noise.
- Fan noise: a fan is necessary to ensure the hob functions correctly and to safeguard the electronic unit from possible overheating. The fan functions at maximum power when the large induction element is at maximum power or when the booster function is on; in all other cases, it works at average power depending on the temperature detected. Furthermore, the fan may continue to work even after switching the hob off, if the temperature detected is high.

The types of noise listed above are due to induction technology and are not necessarily operational faults.

! If the (-) or (+) button is pressed for an extended period of time, the display scrolls quickly through the power levels and timer minutes.

Initial Light Conditions

When power is initially applied to the Cooktop, the touch control conducts a calibration process for the touch keys, which requires a low level of ambient light in the area of the touch keys.

If during this calibration process excessive ambient lighting is detected the User Interface displays „FL” (Infrared Ambient Light Error) and the control calibration process is suspended. In order to rectify the process any lighting that could effect the calibration process should be switched off (e.g. halogen cooker hood lighting). The error will disappear when satisfactory ambient lighting is detected and the touch control calibration procedure will now complete satisfactorily.

-The „FL” error can only be generated within approx 3s of initial power being applied to the cooktop.

-We recommend that the user switches off all cooker hood lighting and lighting directed towards the cooktop when power is initially applied to the cooktop.

-After the touch control has conducted its initial calibration process, (approx 3s) any cooker hood or other lighting can be switched on as normal and will not affect the operation of the touch control.

Switching on the hob

After connecting the hob to the electricity mains, the touch panel might be automatically locked. To unlock the panel press and hold the Control Panel

Lock button .

To switch the hob on, press and hold the  button for approximately one second.

The cooktop is switched On when a beep sound is emitted and all the cooking zones displays show the digit point.

When the cooktop is OFF, after 5 sec the control  switches off the KEYLOCK LED to reduce the power consumption.

As soon as we touch a key, the KEYLOCK LED goes ON and we can continue to use the cooktop, unlocking the keyboard.

Switching off the cooktop is signalled by 3 beep sound

Setting the Power Management

The cooktop maximum power limit is 7200W. This power limit can be reduced by the user to 2800W, 3500W or 6000W.

The sequence to set a new Cooktop Power Limit is:

·During the first 30 seconds after plugging the appliance

·The Touch has to be unlocked and all Heaters Off

·Press at the same time Heater 1 and Heater 3 selection keys

·Once this is done, a beep sounds and the actual Cooktop Power Limit will be shown in the heater displays.

For selecting a new Power Limit:

·With the (+) and (-) keys, the Power Limit is increased.

The selectable powers are: 2800W, 3500W, 6000W or 7200W. When the power is 7200W, if the [+] or [-] key is touched the power changes to 2800W.

The sequence to finish recording the new Cooktop Power Limit is:

·Press at the same time Heater 1 and Heater 3 selection keys

·Once this is done, new Cooktop Power Limit is recorded and there is a system reset.

To finish without recording changes:

·If during 60 seconds there is no action, changes are not recorded and there is a system reset.

Switching on the cooking zones

Each cooking zone is controlled using a selector button



and a power adjustment device consisting of a double(-) and (+) button.

- To begin operating a cooking zone, press the corresponding control button and set the desired power level (between 0 and 9) using the buttons (-) or (+)

Press and hold the (-) button to set the power level immediately at "9"

Press and hold (+) and (-) buttons simultaneously to return to power level "0"

If the power level is "0" press and hold the (+) button to increase the power level quickly

The choice of a cooking zone is signalled by a beep sound, and then the power level is shown on the display

If the selection of a heater is not done in 10 seconds, the cooktop will be turned off automatically.

Fast Boil- "Booster" function

The booster function for some of the cooking zones may be used to shorten heating-up times.

It may be activated by pressing the (+) button over level 9. This function boosts the power to 1600 W or 2000 W, depending on the size of the relevant cooking zone.

The activation of the booster is signalled by a beep sound, and the letter 'P' appearing on the display.

The booster works for max 10 minutes. After these 10 minutes a beep sounds and the cooking zone will return to level "9"

With the heater at Booster level, if the [+] key is Touched an error beep sounds and the cookset doesn't change. With the heater at Booster level, if the [-] key is Touched a beep sounds and the cookset is reduced to 9.

Switching off the cooking zones

To switch off a cooking zone, select it using the corresponding selector button  and:

- Press the (-) button: the power of the cooking zone will progressively decrease until it is switched off.

Once the cooking zone is selected, the heater can also be switched off by touching the [-] and [+] keys simultaneously. A beep

sounds and the corresponding display shows "0".

Using the Timer

! All the cooking zones may be programmed simultaneously, for a duration between 1 and 99 min.

1. Select the cooking zone using the corresponding selector button.

2. Adjust the power level of the cooking zone.

3. When required power level is selected, touching again the corresponding heating zone selector button, a beep sounds and a 't' letter with dot point appears on the heater display. The remaining time will be displayed in the opposite part of timed heater. If timed heating zone is, for example, in the down part, timed time will appear in up displays.

4. Set the cooking duration using the (-) and the(+) buttons

The (-) and the(+) buttons touched simultaneously result in returning to the 0 value.

If the time is not selected before 10 seconds, or if the selected time is 0 after 10 seconds the last touch over the (-)or the (+) button, the timer is switched off.

Starting Timer countdown.

The countdown starts when the timer visualization is finished touching any cooking zone key or automatically 10 seconds after the last touch over the [+] or [-] keys. A beep sounds and the heater display will show the power level and the dot point showing that the heater is timed.

! To change the time for a timed heater, repeat the process explained above.

! Pressing and holding the + and - keys increases the speed of time selection

End of Timer countdown.

When the remaining time has run out, the timed heater is switched off, the heater display shows a blinking '0' and the timer alarm beeps for one minute

The alarm will be cancelled by pressing any key of the touch control.

Control panel lock

When the hob is switched on, it is possible to lock the oven controls in order to avoid accidental changes being made to the settings (by children, during cleaning, etc.).

Press the  button to lock the control panel: -the icon will illuminate and an audible beep sound will be emitted. To use any of the controls (e.g. to stop cooking), you

must switch off this function. Press the  button for a few moments, the icon will stop illuminating and the lock function will be removed.

All the keys on the cooking zone selection will be locked if:
 if the cooktop is off,
 if the Control Panel Lock is activated or
 if an error on a cooktop occurs.

Switching off the hob

Press the button  to switch off the appliance - do not rely solely on the pan sensor.

If the control panel lock has been activated, the controls will continue to be locked even after the hob is switched on again. In order to switch the hob on again, you must first remove the lock function.

Practical advice on using the appliance

! Use cookware made from materials which are compatible with the induction principle (ferromagnetic material). We especially recommend pans made from: cast iron, coated steel or special stainless steel adapted for induction. Use a magnet to test the compatibility of the cookware.

! Do not use adapters, diffusers, or metal plates on the cooking zones. They may have a detrimental effect upon the hob's performance, and might damage the hob's aesthetics.

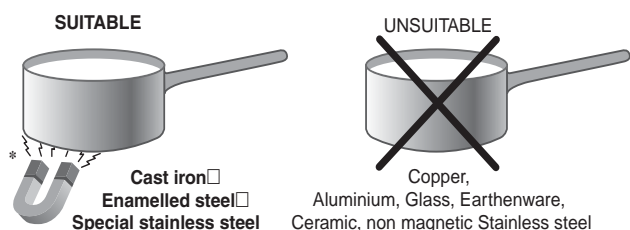

In addition, to obtain the best results from your hob:

- Use pans with a thick, flat base in order to fully utilise the cooking zone.

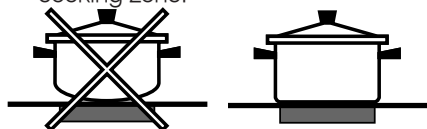

- Always use pans with a diameter which is large enough to cover the hotplate fully, in order to use all the available heat.



- Make sure that the base of the cookware is always clean and dry, in order to fully utilise and extend the life of both the cooking zones and the cookware.
- Avoid using the same cookware which has been used on gas burners: the heat concentration on gas burners may distort the base of the pan, causing it not to adhere correctly.

Safety devices

Pan sensor

Each cooking zone is equipped with a pan sensor device. The hotplate only emits heat when a pan with suitable measurements for the cooking zone is placed on it.

The "u" sign on the display appears if after selecting the cooking zone the pan is not placed on a heater, or in case of:

- An incompatible pan
- A pan whose diameter is too small
- The pan has been removed from the hotplate.

After 10 sec. with no pan on the heating zone, a warning beep signal is emitted.

After 60 sec. with no pan on the heating zone, the heater switches off.

Overheating protection

If the electronic elements overheat, the number signaling the power level starts flashing, and the letter "c" appears on the display. When the temperature has reached a suitable level, this message disappears and the hob may be used again.

Safety switch

The appliance has a safety switch which automatically switches the cooking zones off after they have been in operation for a certain amount of time at a particular power level. When the safety switch has been triggered, the display shows "0".

For example: the right rear hotplate is set to 5 and will switch off after 5 hours of continuous operation, while the front left hotplate is set to 2 and will switch off after 8 hours. When one or more keys are activated for more than 10 sec. the touch control switches off.

A warning beep sounds is emitted every 10 sec., while the key/s is/are activated.

With all heaters at zero power during 10 sec. the Cooktop is switched off.

If the switching off is due to an accidental activation of keys, the touch control actuates as above.

Buzzer

This can also indicate several irregularities:

- An object (a pan, cutlery, etc.) has been placed on the control panel for more than 10 seconds.
- Something has been spilt on the control panel.
- A button has been pressed for too long. All of the above situations may cause the buzzer to sound. Remove the cause of the malfunction to stop the buzzer. If the cause of the problem is not removed, the buzzer will keep sounding and the hob will switch off.













Errors and Alarms

When an error is detected, the whole appliance or the heater/s are switched off, a beep sounds (only if one or more heaters are active) and all displays show a 'F' letter and the error code (an index number or a letter) alternately.

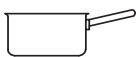
If the problem does not disappear by itself, please contact the Technical Service.

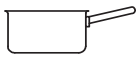
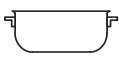
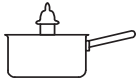
Power level	Maximum operating time in hours
1	9
2	8
3	7
4	6
5	5
6	4
7	3
8	2
9	1

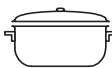
Practical cooking advice

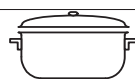
Very high-flame cooking	9	 Pressure cooking Pressure cooker	 Frying
	8	 Grilling	 Boiling
High-flame cooking	7	 Crêpes	 Cooking on a high flame and browning (roasts, steaks, escalopes, fish fillets, fried eggs)
Medium-flame cooking	6	 Fast thickening (liquid juices) Boiling water (pasta, rice, vegetables) Milk	
	5	 Slow thickening (dense juices)	
	4	 Bain-marie cooking	 Pressure cooking after whistle
Low-flame cooking	3	 Low-flame cooking (stews)	 Reheating dishes
Very low-flame cooking	2	 Chocolate sauce	 Keeping food hot

! This appliance has been designed and manufactured in compliance with international safety standards. The following warnings are provided for safety reasons and must be read carefully.

 This appliance conforms to the following European Economic Community directives:

- 2006/95/EEC dated 12/12/06 (Low Voltage) and subsequent amendments;
- 2004/108/EEC dated 15/12/04 (Electromagnetic Compatibility) and subsequent amendments;
- 93/68/EEC dated 22/07/93 and subsequent amendments.
- 1275/2008 stand-by/off mode.

General safety

! Make sure that the air inlet behind the fan grille is never obstructed. The built-in hob should, in fact, be provided with suitable ventilation for the cooling of the electronic components used in the appliance.

! We advise against the installation of an induction hob above an under-the-counter refrigerator (heat) or above a washing machine (vibrations). In fact, there would be insufficient space for the ventilation of electronic components.

- The appliance was designed for domestic use inside the home and is not intended for commercial or industrial use.
- The appliance must not be installed outdoors, even in covered areas. It is extremely dangerous to leave the appliance exposed to rain and storms.
- Do not touch the appliance when barefoot or with wet or damp hands and feet.
- The appliance must be used by adults only for the preparation of food, in accordance with the instructions provided in this booklet. Do not use the hob as a worktop or chopping board.
- The glass ceramic hob is resistant to mechanical shocks, but it may crack (or even break) if hit with a sharp object such as a tool. If this happens, disconnect the appliance from the electricity mains immediately and contact a Service Centre.
- Ensure that power supply cables of other electrical appliances do not come into contact with the hot parts of the hob.
- Remember that the cooking zones remain relatively hot for at least thirty minutes after they have been switched off. An indicator light provides a warning when residual heat is present (see **Start-up and use**).
- Keep any object which could melt away from the hob, for example plastic and aluminium objects, or products with a high sugar content. Be especially careful when using plastic film and aluminium foil or packaging: if placed on surfaces which are still hot, they may cause serious damage to the hob.
- Always make sure that pan handles are turned towards the centre of the hob in order to avoid accidental burns.
- When unplugging the appliance, always pull the plug from the mains socket; do not pull on the cable.

- Never perform any cleaning or maintenance work without having disconnected the appliance from the electricity mains.
- The appliance should not be operated by people (including children) with reduced physical, sensory or mental capacities, by inexperienced individuals or by anyone who is not familiar with the product. These individuals should, at the very least, be supervised by someone who assumes responsibility for their safety or receive preliminary instructions relating to the operation of the appliance.

- For the attention of wearers of pacemakers or other active implants:

The hob complies with all current standards on electromagnetic interference.

Your induction hob is therefore perfectly in keeping with legal requirements (89/336/CEE directives). It is designed not to create interference on any other electrical apparatus being used on condition that the apparatus in question also complies with this legislation.

Your induction hob generates short-range magnetic fields.

To avoid any interference between your induction hob and a pacemaker, the latter must be designed to comply with relevant regulations.

In this respect, we can only guarantee our own product conformity. Please consult the pacemaker manufacturer or your doctor concerning its conformity or any possible incompatibility.

- Do not let children play with the appliance.
- Do not place metal objects (knives, spoons, pan lids, etc.) on the hob as they may become hot.
- **The appliance is not intended to be operated by means of an external timer or separate remote-control system.**



Disposal

- When disposing of packaging material: observe local legislation so that the packaging may be reused.
- The European Directive 2002/96/EC relating to Waste Electrical and Electronic Equipment (WEEE) states that household appliances should not be disposed of using the normal solid urban waste cycle. Exhausted appliances should be collected separately in order to optimise the cost of re-using and recycling the materials inside the machine, while preventing potential damage to the atmosphere and to public health. The crossed-out dustbin is marked on all products to remind the owner of their obligations regarding separated waste collection.

For further information relating to the correct disposal of exhausted household appliances, owners may contact the public service provided or their local dealer.

Care and maintenance

GB

Switching the appliance off

Disconnect your appliance from the electricity supply before carrying out any work on it.

Cleaning the appliance

! Do not use abrasive or corrosive detergents (for example, products in spray cans for cleaning barbecues and ovens), stain removers, anti-rust products, powder detergents or sponges with abrasive surfaces: these may scratch the surface beyond repair.

! Never use steam cleaners or pressure cleaners on the appliance.

- It is usually sufficient simply to wash the hob using a damp sponge and dry it with absorbent kitchen towel.
- If the hob is particularly dirty, rub it with a special glass ceramic cleaning product, then rinse well and dry thoroughly
- To remove more stubborn dirt, use a suitable scraper. Remove spills as soon as possible, without waiting for the appliance to cool, to avoid residues forming crusty deposits. You can achieve excellent results by using a rust-proof steel wire sponge - specifically designed for glass ceramic surfaces - soaked in soapy water.
- If any plastic or sugary substances are accidentally melted on the hob, remove them immediately with the scraper, while the surface is still hot.

- Once it is clean, the hob may be treated with a special protective maintenance product: the invisible film left by this product protects the surface from drips during cooking. This maintenance task should be carried out while the appliance is warm (not hot) or cold.
- Always remember to rinse the appliance well with clean water and dry it thoroughly: residues can become encrusted during subsequent cooking processes.

Stainless steel frame (only in models with outer frame)

Stainless steel can be marked by hard water which has been left on the surface for a long time, or by cleaning products containing phosphorus.

After cleaning, it is advisable to rinse the surface well and dry it thoroughly. If water is spilt on the surface, dry it quickly and thoroughly.

! Some hobs have an aluminium frame which is similar to stainless steel. Do not use any cleaning or degreasing products which are not suitable for use with aluminium.

Disassembling the hob

If it is necessary to disassemble the hob:

1. Loosen the screws fixing the alignment springs on each side.
2. Loosen the screws holding the fixing hooks in each corner.
3. Take the hob out of its installation cavity.

! Do not attempt to repair the appliance yourself. If the appliance breaks down, contact a Service Centre.

Technical description of the models

Hobs	CIB 644 C E CIB 64 C. S CIB644.1 CE CIB 644 B E
Cooking zone	Power (W)
Back Left	I 1200 - B1600
Back Right	I 1500 - B 2000
Front Left	I 1500 - B 2000
Front Right	I 1200 - B1600
Total power	7200

The induction system is the quickest existing way of cooking. Unlike traditional hotplates where the cooking zone heats up, with the induction system heat is generated directly inside pans which have ferromagnetic bases.

Key:

I = single induction cooking zone

B = booster: the power level of the cooking zone may be boosted

Guarantee

12 months Parts and Labour Guarantee

Your appliance has the benefit of our manufacturer's guarantee, which covers the cost of breakdown repairs for twelve months from the date of purchase.

This gives you the reassurance that if, within that time, your appliance is proven to be defective because of either workmanship or materials, we will, at our discretion, either repair or replace the appliance at no cost to you.

The guarantee is subject to the following conditions:

- The appliance has been installed and operated correctly and in accordance with our operating and maintenance instructions.
- The appliance is only used on the electricity or gas supply printed on the rating plate.
- The appliance has been used for normal domestic purposes only.
- The appliance has not been altered, serviced, maintained, dismantled or otherwise interfered with by any person not authorised by us.
- Any repair work must be undertaken by us or our appointed agent.
- Any parts removed during repair work or any appliance that is replaced become our property.
- The appliance is used in the United Kingdom or Republic of Ireland.

The guarantee does not cover:

- Damage resulting from transportation, improper use, neglect or interference or as a result of improper installation.
- Replacement of any consumable item or accessory. These include but are not limited to: plugs, cables, batteries, light bulbs, fluorescent tubes and starters, covers and filters.
- Replacement of any removable parts made of glass or plastic.

THE GUARANTEE WILL NOT APPLY IF THE APPLIANCE HAS BEEN USED IN COMMERCIAL OR NON-DOMESTIC PREMISES.

5 Year Parts Guarantee

Hotpoint also offers you a FREE 5 year parts guarantee. This additional guarantee is conditional on you registering your appliance with us and the parts being fitted by one of our authorised engineers. There will be a charge for our engineer's time. To activate the extra parts warranty on your appliance, simply call our registration line on **08448 24 24 24 (ROI 01 230 0800)**

Extended Guarantees

We offer a selection of protection plans that enable you to fully cover yourself against the expense of repair bills for the life of your policy. To find the ideal plan for you please call our advice line on **08448 226 226 (ROI 01 230 0233)**

Free Helpdesk Service

We have a dedicated team who can provide free advice and assistance with your appliance if you experience any technical difficulties within the first 90 days of ownership. Simply call our Hotpoint Service Hotline on **08448 224 224 (ROI 0818 313 413)** for telephone assistance, or, where necessary, to arrange for an engineer to call.

After Sales Service

No one is better placed to care for your Hotpoint appliance during the course of its working life than us - the manufacturer.

Essential Contact Information

Hotpoint Service

We are the largest service team in the country offering you access to 400 skilled telephone advisors and 1100 fully qualified engineers on call to ensure you receive fast, reliable, local service.

UK: 08448 224 224

Republic of Ireland: 0818 313 413

www.hotpoint.co.uk

Please note: Our advisors will require the following information:

Model number

Serial number

Parts & Accessories

We supply a full range of genuine replacement parts as well as accessory products that protect and hygienically clean your appliance to keep it looking good and functioning efficiently throughout its life.

UK: 08448 225 225

Republic of Ireland: 0818 313 413

www.hotpointservice.co.uk

Appliance Registration

We want to give you additional benefits of Hotpoint ownership. To activate your FREE 5 year parts guarantee you must register your appliance with us.

UK 08448 24 24 24

Republic of Ireland: 01 230 0800

www.hotpointservice.co.uk

As part of Hotpoint's continued commitment to helping the environment, Hotpoint reserves the right to use quality, recycled components to keep down customer costs and minimise material wastage.

Indesit Company UK Limited, Morley Way, Peterborough, PE2 9JB
Indesit Company, Unit 49 Airways Industrial Estate, Dublin 17

Free Manuals Download Website

<http://myh66.com>

<http://usermanuals.us>

<http://www.somanuals.com>

<http://www.4manuals.cc>

<http://www.manual-lib.com>

<http://www.404manual.com>

<http://www.luxmanual.com>

<http://aubethermostatmanual.com>

Golf course search by state

<http://golfingnear.com>

Email search by domain

<http://emailbydomain.com>

Auto manuals search

<http://auto.somanuals.com>

TV manuals search

<http://tv.somanuals.com>