

HYUNDAI DUCTLESS SPLIT SYSTEMS

SINGLE AND MULTI-ZONE

SINGLE ZONE

COOLING ONLY

HACW09DB – HCCW09DB
HACW12DB – HCCW12DB
HACW18DB – HCCW18DB
HACW24DB – HCCW24DB

COOLING AND HEATING

HAHW12DB – HCHW12DB
HAHW18DB – HCHW18DB
HAHW24DB – HCHW24DB

HYUNDAI

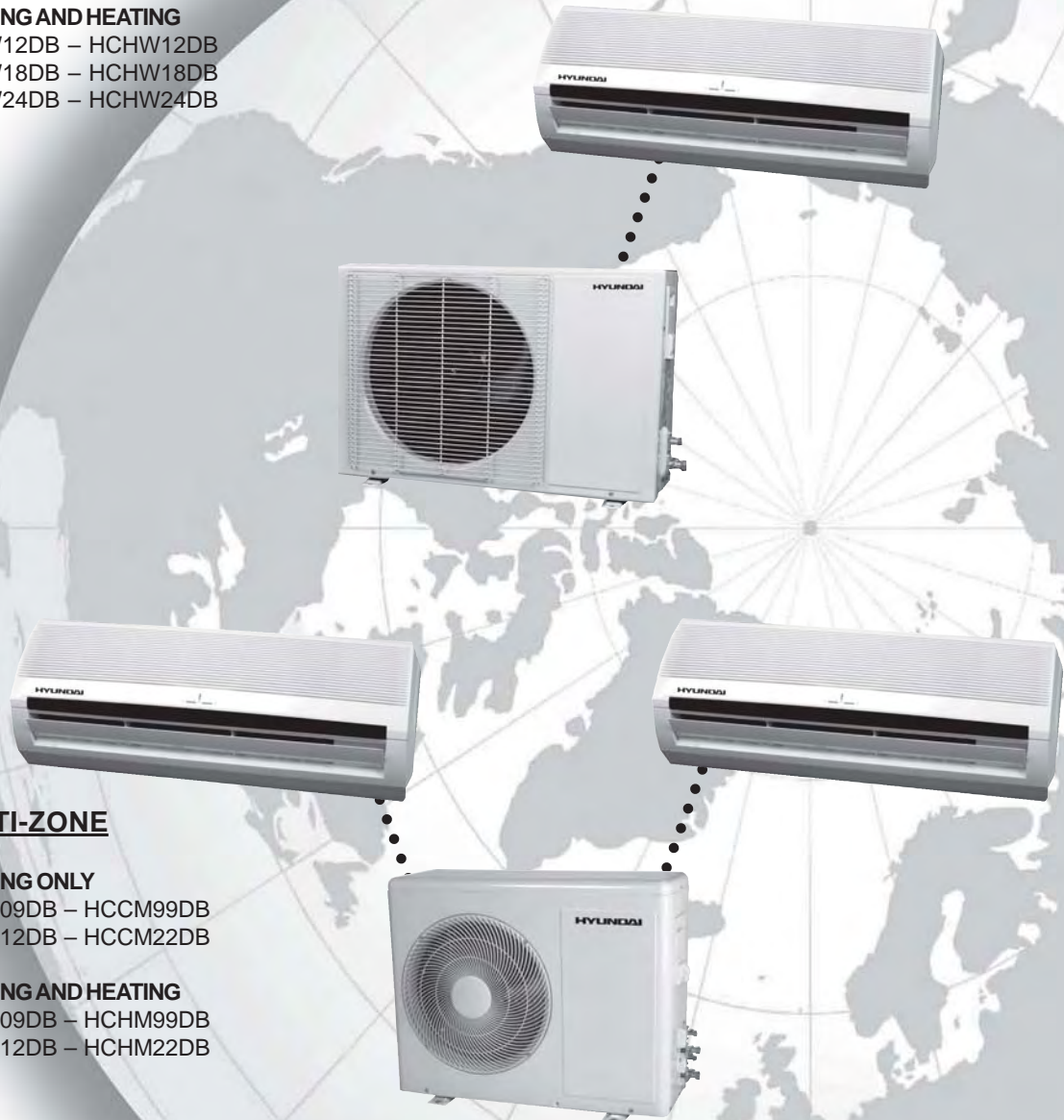

MULTI-ZONE

COOLING ONLY

HACM09DB – HCCM99DB
HACM12DB – HCCM22DB

COOLING AND HEATING

HAHM09DB – HCHM99DB
HAHM12DB – HCHM22DB

ECR INTERNATIONAL

85 Middle Rd.
Dunkirk, NY 14048
Ph: (716) 366-5500
Fax: (716) 366-1209
www.ecrinternational.com

An **ECR International Brand**
An ISO 9001-2000 Certified Company



Rev. 2.4 [08/04]

SAFETY TIPS FOR OPERATION

⚠ WARNING ⚠

- Do not place animals, plants, or combustible equipment in the path of the unit air flow.
- Do not touch the unit(s) with wet hands.
- Do not put anything in the air inlet(s) or outlet(s) especially on the outdoor (condenser) unit. Children are particularly liable to this danger. The fan is running at high speed inside. Covering the units or blocking them will cause the deterioration of air conditioner performance or cause malfunction.
- Do not apply excessive force to terminal connections.
- Connect the air conditioner(s) to a (dedicated) electrical circuit.
- In the event of lightning, stop the air conditioner(s) and disconnect the power source.
- Do not touch the heat exchanger, pipes and valves on the outdoor unit during cooling cycle. You may get burned.
- The fuse or the circuit breaker must comply with national and local codes.
- Do not modify the system(s). It may increase the risk of fire.

⚠ CAUTION ⚠

- Never expose infants, handicapped persons, or seniors directly to the airflow. Adjust the room temperature and the airflow direction.
- Make sure that the indoor and outdoor unit(s) are installed out of the reach of children.
- Do not use the air conditioner(s) for preservation of food-stuffs, animals, plants, precision appliances, arts and medicine.
- Do not sit on or place objects on the unit(s).
- Use ASHRAE or MANUAL -J to calculate the cooling load.
- The current temperature indicated on the remote control(s) can be different from the actual temperature of the room.
- Any function indicated by a * is limited to heating model only.

FEATURES

DEODORIZING FUNCTION

In case of DRY and COOL mode, the fan or indoor unit(s) will not turn ON for 40 seconds even after starting the operation in order to deodorize various smells emitting from the inside of indoor unit.

MELODY BUZZER

When selecting ON/OFF and function changes, a melody will sound from the indoor unit(s) to indicate that the change has occurred.

COMPONENTS AND FUNCTIONS

For the proper use, please check and identify the name and location of each part.

Indoor Unit(s)

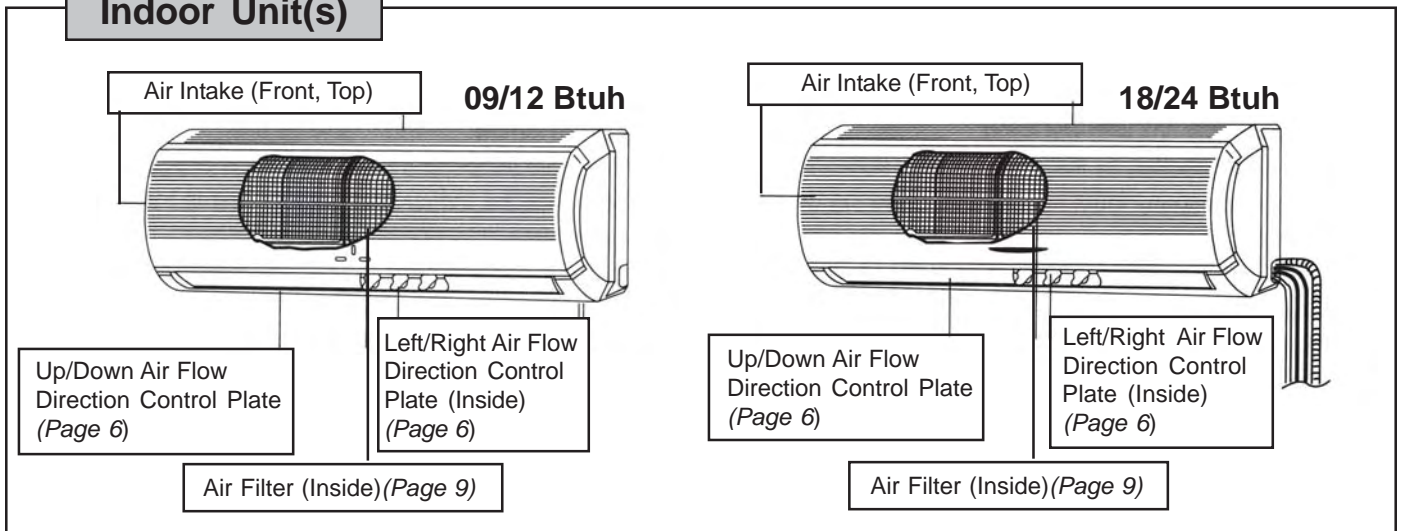

Control Keys of Main Unit

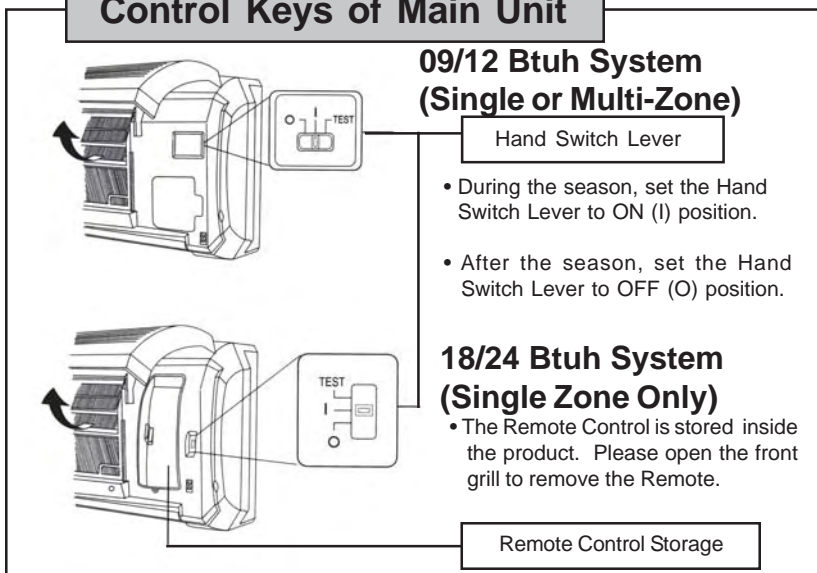

Preparation For Use

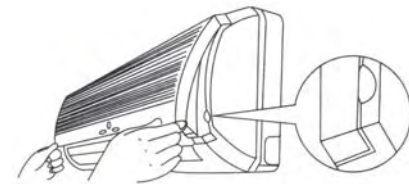

- 1 Lift up the front grille.
- 2 Turn the Hand Switch Lever to ON position.

Outdoor Unit

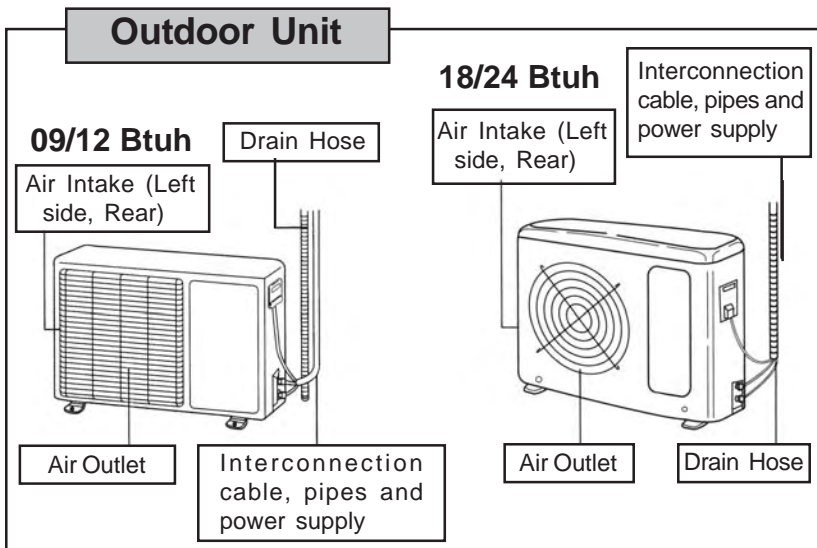

Mode of Operation Indicator

- Operation Lamp
- Timer Lamp
- Heat Operation Lamp
- Sleep Lamp
- High Power Lamp

PART NAME OF REMOTE CONTROL AND KEY FUNCTION

Operation starts by manipulating the Remote Control. Please check and identify the name and location of part.

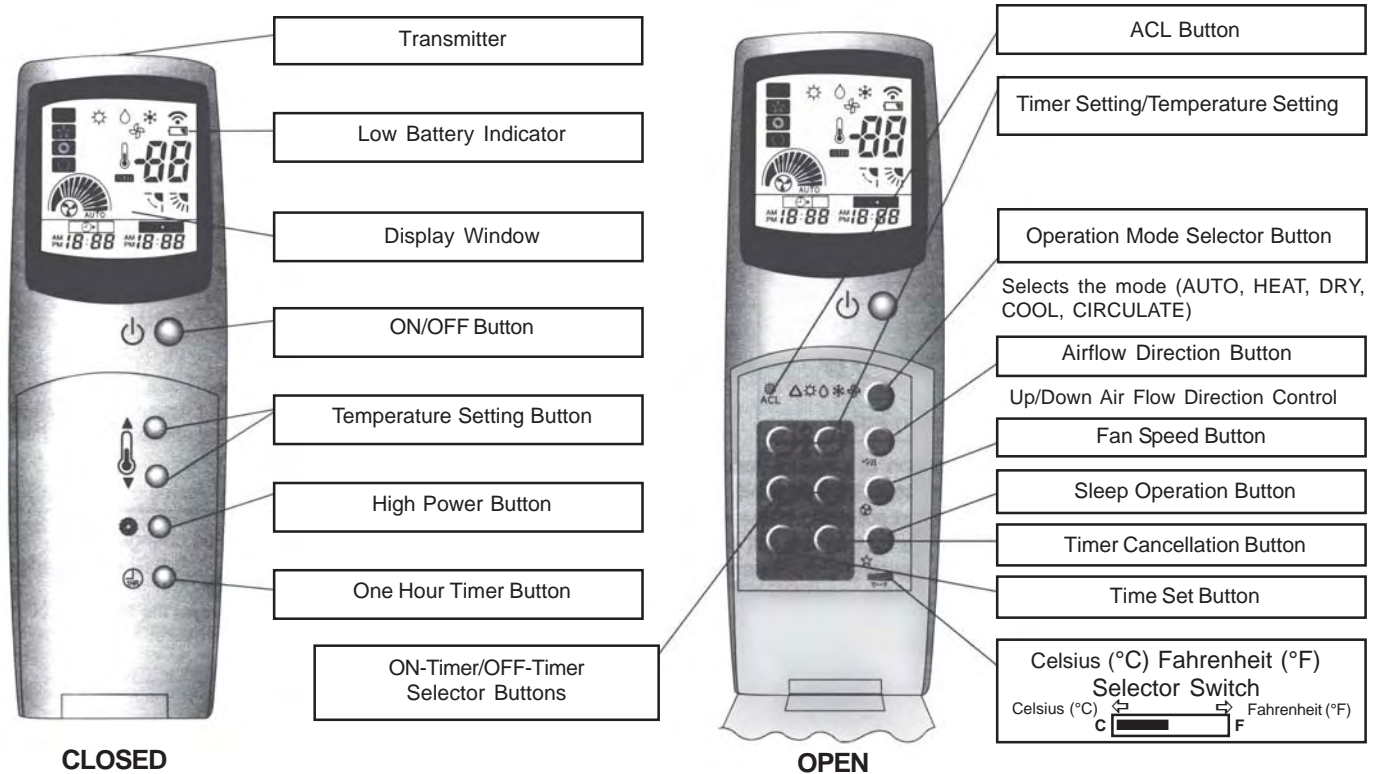

PREPARATION BEFORE OPERATION

INSTALLING BATTERIES

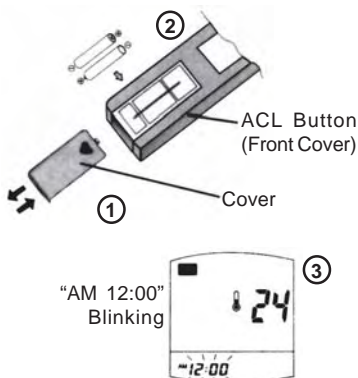

- To lift the cover press in and up on the lid latch with your thumb nail.
- Insert two (2) (AAA) size batteries according to the plus (+) and minus (-) markings. Always use Alkaline batteries.
- Replace cover.
- Press the "ACL" button on the face of the Remote.

INSTALLING REMOTE CONTROL HOLDER(S)

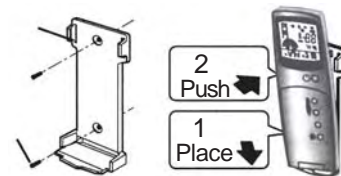

- Place the bottom of the Remote Control on the hook first and then push it into the holder.

NOTE: The transmitting distance may be shorter in a place where the room has electronic lighting equipment.

CURRENT TIME ENTRY

(Example) Setting AM 10:00;

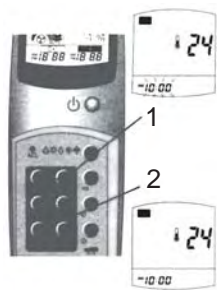

- Set time AM 10:00 by pressing the ▲▼ button.
 - Time can be adjusted by pressing and holding the button. It can also be adjusted in one minute intervals by single pressing and releasing the ▲▼ button.
- Set current time by pressing the ⌚ button.

NOTE: If current time is not set correctly, the timer will not operate normally.

CAUTION

- If the batteries are not in use for a prolonged period of time, remove them from the battery compartment to avoid undue draining.
- The batteries can be used for about 6 months. If the Remote Control is not operating even when placing it near the receiver, replace them with 2 new batteries and press the ACL button.
- Please do not use manganese batteries. It may cause the remote to malfunction.
- Avoid extremely hot or cold locations such as placing it near or over a radiator, or in direct sunlight. Also avoid placing it near fluorescent lighting.
- Do not let children play with the Remote Control.
- To avoid interference, the indoor unit and the Remote control unit should be at least 3 feet away from a TV set or a radio.
- In cases where than two air conditioners are installed in the same room, individual operation may not be possible.

OPERATION

AUTO OPERATION

- Air-Conditioner(s) automatically selects the proper room temperature.

1. Press the **(MODE)** button on the Remote Control, and select AUTO () mode.



2. Press the ON/OFF  button.



STOP

Press the ON/OFF  button again.

- Auto Mode controls every function of the air conditioner in order for you to feel as comfortable as possible.
- The operation is automatically controlled according to the room temperature and humidity. (When you turn on the unit again within 2 hours of operation, the operation proceeds in the same way as before.)

Room Temperature	Operating Mode	Set Temp.
Over 27°C (81°F)	Cool	26°C (79°F):18/24K 27°C (81°F):9/12K
20~27°C (68~81°F)	Dry	Monitor
Below 20°C (68°F)	Heat	24°C (75°F)

- The room temperature is adjustable as you desire by pressing the room temperature setting.
- The adjustable range is up to 4°C (8°F) plus or minus.
- Automatic operation will not show the set room temperature.
- The room temperature automatically appears in the display indicator about 5 seconds after adjustment.

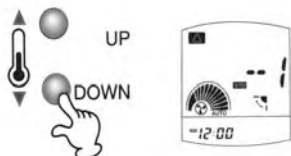

DRY MODE

- If you want the room thermostat to monitor the difference between room temperature and set temperature, select either COOL or DRY mode.
- In the DRY mode, the fan is running to remove the humidity without dropping the room temperature.
- If Dry mode is selected, the Indoor/Outdoor Unit(s) can be controlled very precisely and the humidity inside the room is removed. Recommended at humid weather such as rainy days, etc. When outside temperature is too low or room size is too small, the room temperature may go down further than the set point.
- When the room temperature is below 59° F , the operation is stopped and the unit is switched to the Wait Mode at which time the room temperature is monitored.

MANUAL OPERATION

- In case you are not satisfied with various conditions of automatic operation, you can select these conditions as you wish.

- Select HEAT, DRY, Cool or CIRCULATE mode as you wish.

1 Press the **(MODE)** button on the Remote Control.

- Cold weather -----> **HEAT**  mode
- High humidity -----> **DRY**  mode
- Hot weather -----> **COOL**  mode
- When air circulation is needed -> **CIRCULATE**  mode



2 Press the ON/OFF  button



When the fan speed or air flow direction is to be changed.

- When the set temperature is to be changed:

Press the SET TEMP () button.

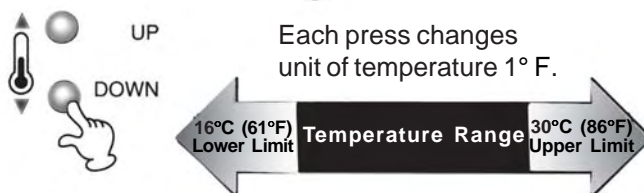

OPERATION (Continued)

HEAT MODE (Except Cool model)

■ Heating Capability:

- ~ This is a Heat pump type air conditioner which is heating the room by absorbing the outside air to the room. Therefore, as outside temperature drops, heating capability may be reduced.
- ~ If heating is not enough, please use another heating source together with the unit(s).

- This is a warm air circulating system for heating the room. Therefore it will take time to heat the whole room.

■ Features of Heating Operation:

- ~ If there is frost on the outdoor unit, the heating capacity will drop. Therefore, defrosting operates automatically (approx. 5 to 12 minutes) and the indicator light on the indoor unit(s) will blink (red).
- ~ The room and outdoor fan does operate during defrosting and the unit will not run during this time.

! CAUTION !

- In case of Cool and Dry mode, water may drop according to the contaminating status of air filter. In this case, please clean or replace the air filter with a new one.

FAN SPEED, AIR FLOW DIRECTION

- To operate the unit(s) effectively, it is recommended that you familiarize yourself with the following functions:

- To change the fan speed
Press the FAN SPEED () button.

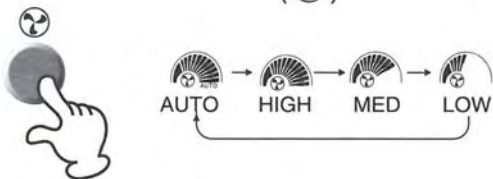

- Cold air moves down, horizontal air flow is preferred when cooling.

- To change the air flow Up or Down
Press the Flap () button.

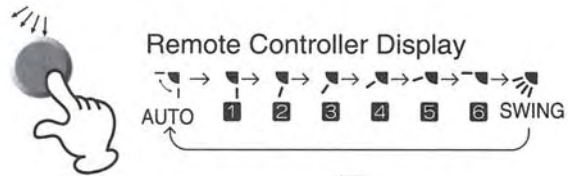

- Up/Down Moving range of Airflow Direction Control Plate.

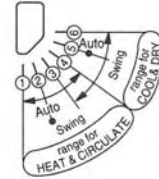

- Left-right airflow direction is adjusted manually.
- As shown in the figure below adjust the left-right airflow direction with the right/left air flow control plate.

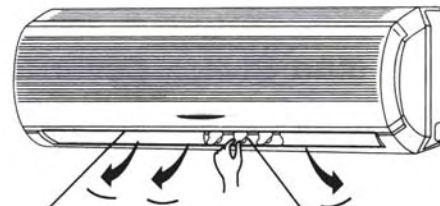

- Up/Down Air Flow Control Plate

- Right/Left Air Flow Control Plate

CIRCULATION MODE

- If CIRCULATION mode is selected, the room air is circulated so that the temperature stratification in the room will be reduced.
- You can select AUTO, HIGH, MED, or LOW speed.
- In the AUTO fan speed, the room temperature, set temperature and the unit temperature are monitored so that the circulation can be properly controlled.

OPERATION (Continued)

TIMER MODE (ON, OFF)

- The timer can be set during any mode.
Select the timer setting by pressing:

ON-TIMER  button or OFF-TIMER  button.



(Example)

Time is AM 10:20. Air-conditioner is not in operation.
How to start the air conditioner at PM 1:30 and stop it at PM 6:30.

- Press the  button.



 mark will blink



- Press  button to adjust ON TIMER to PM 1:30 (Time can be adjusted at hour intervals by pressing and holding  button. Time can also be adjusted by 10-minute intervals by pressing  button at center interval.

- Press the TIMER  button.

- Press the  button.



 mark will blink

- Press  button to adjust OFF TIMER to PM 6:30
Time can be adjusted at hour intervals by pressing and holding  button. Time can also be adjusted by 10-minute intervals by pressing  button at center interval.

- Press the TIMER  button.

To CANCEL Press the “C” button.

Check if current time is set correctly.
If current time is not correct, timer will not operate at desired time.

OPERATION CONDITION

- Operation Temperature Range:

HYUNDAI OPERATING RANGES

Mode	Temperature (°F)		Indoor Humidity
	Indoor	Outdoor	
Cool	70-90	70-109	<80%
Dry	59-90	59-109	<80%
Heat	59-81	32-75	<80%

- If you operate the unit(s) at other than the above conditions, a safety device may be activated and shut off the power.
- On humid days, frost may form on the surface of air conditioner or condensation may occur.

HIGH POWER MODE

Convenient on a hot day. (During AUTO, HEAT, COOL or DRY mode)

Press the HIGH POWER  button.

To CANCEL:

Press the HIGH POWER button once more. The operation is set back to the previous operation mode.

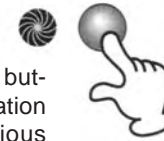

HIGH POWER MODE

When the HIGH POWER mode button is pressed, heated or cooled air comes into the room at a higher fan speed for 15 minutes. The fan speed changes rhythmically between high and ultra-high.

CAUTION

When the air conditioner(s) continue to run on HIGH POWER mode in a large room, they may not reach the set room temperature due to limited cooling capacity. This may cause water drops to form around the outlet. In such cases, please switch to MANUAL mode.

OPERATION (Continued)

SLEEP MODE

The desired room temperature is maintained quietly at lower fan speed. (During AUTO, HEAT, COOL or DRY mode)

Press the SLEEP  button.

To CANCEL:

Press the SLEEP button once more. The mode is set back to the previous operating mode.

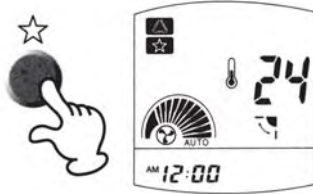

SLEEP MODE

- Decreases the fan speed of Indoor Unit(s) automatically and quiet operation is carried out.
- When Sleep mode starts to operate, desired temperature will change automatically (see below).

Heat*	3°C(6°F) down an hour after
	4°C(8°F) down another 3-hours after
Cool & Dry	1°C(2°F) goes up an hour after

- When sleep mode starts to operate, flaps will move up or down by one-step automatically.

Cool/Dry	Move up by one-step
Heat*	Move down by one-step

1HR TIMER MODE

- This mode is convenient to use before sleeping or leaving.

Press the 1HR TIMER  button.

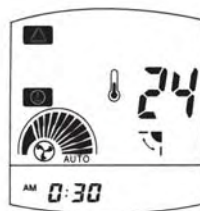
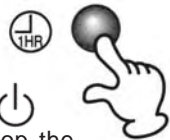

To CANCEL:

Press the ON/OFF  button. This will stop the ONE HOUR TIMER operation. Then press the ON/OFF button again, the unit will be set to the previous operating mode.



- Upon input, one-hour timer is set at display and 0:30 is indicated current time.
- If 1hr timer is set, the remaining minutes will be indicated.

NOTE:

- If pressing the 1HR TIMER  button again during the ONE HOUR TIMER mode, the unit will stop operation approximately one (1) hour later.
- The ONE HOUR TIMER mode has preference over other Timer modes. If pressing the 1HR TIMER  button again during the OFF TIMER mode, the unit(s) will stop operating approximately one (1) hour later.

EMERGENCY OPERATION

When the remote control cannot be used due to dead batteries or out of order, use the Hand Switch Lever.

After turning the Hand Switch Lever to OFF "O" position, turn it to ON "I" again.

The lamp will light and the unit(s) will start in the Automatic operation mode.

9/12 Btuh

18/24 Btuh

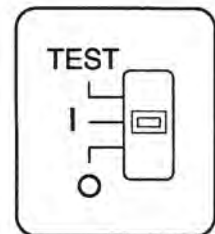
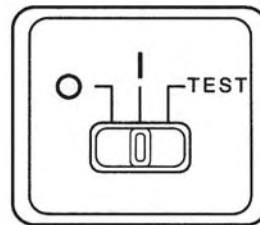

To STOP: Turn the Hand Switch Lever to OFF "O" position.

MAINTENANCE

ROUTINE MAINTENANCE

- Be sure to stop the operation and disconnect the power source before performing any checks or cleaning.
- Do not wet the air conditioner(s).
- Benzene, thinner and cleaning powder may damage the coated surface or the plastics.
- Do not use water higher than 40° C (104° F), or the air filters may shrink and the plastic materials may be damaged.
- Do not touch the evaporator coil when removing and replacing the air filters. Injury may occur.
- Never operate the unit without the air filters.

1. CLEANING AIR FILTERS (ONCE EVERY TWO WEEKS)

Clean the air filters at least once every two weeks to save electricity. Use the vacuum cleaner to remove dust from the air filter.

NOTE: In case the dust on the air filter cannot be easily removed with a vacuum cleaner, use a neutral cleaning agent. Be sure to sufficiently rinse the air filter with water to completely remove the cleaning agent and allow it to dry in the shade.

How to remove air filters:

- A) Pull the front grille by grasping the recesses on the ends.
- B) Open the front grille up to the position where it is stopped with a click sound.
- C) Raise the air filter, disengage the claws, and remove.

How to replace air filters:

- A) Place the air filters with "Front" marking facing toward you in the reverse order of mentioned "How to remove air filters".
- B) Gently push to close the front grille to the unit.
- C) Secure the grille in position by pressing evenly along the lower edge.

2. CLEANING INDOOR UNIT(S) & REMOTE CONTROL(S)

Use a dry cloth for cleaning the indoor unit(s) and remote control(s).

BEFORE THE SEASON

- Check that the air inlet and outlet of the indoor and outdoor units are not blocked.
- Check that the ground wire is connected and there is no wire breaks anywhere.
- Check that the installation bracket is not corroded or rusty.
- Check that the air filters are clean and in place.

AFTER THE SEASON

- Operate on "CIRCULATION" only mode for several hours on a dry day. Storage when wet will allow mold to develop.
- Disconnect the power source
- Remove the batteries from the remote control.
- Clean the air filters and replace.

BEFORE CALLING FOR SERVICE

THE FOLLOWING ARE NOT DEFECTS

- **A hissing noise or hollow sound:**
This sound may be generated from the refrigerant flowing within pipes during operation or after turning off the unit(s).
- **A squeaking noise:**
This noise is generated from the air conditioner(s) when it expands or contracts due to temperature changes.
- **A rustling noise:**
This noise is generated from the indoor fan at start up.
- Operating sounds may change:
The operation sounds varies with the fan speed.
- **Odors:**
Such odors as tobacco, cosmetics, or foods may accumulate in the indoor unit(s).
- **Indoor fan motor(s) stop:**
In the "AUTO", "DRY" and "HEAT" operation mode, the indoor fan motor(s) will be stopped when the room temperature reaches the set temperature.
- **The air conditioner(s) do not start or change operation mode immediately:**
To prevent overloading the compressors, the air conditioner(s) will not start for approx. 3 minutes.
- **No change on the operation mode by the remote control:**
The signal of operation mode changing has not reached the indoor unit(s). Press the ON/OFF button again and change the operation mode.
- **The fan speed of the indoor fan motor changes or the fan motor of the outdoor unit stops:**
To prevent overloading the unit, the air conditioner(s) may change the indoor fan speed and operate the outdoor fan intermittently.
- **In heat mode water comes out the outdoor unit:**
The ambient air can condense on the pipes of the outdoor unit.

BEFORE CALLING FOR SERVICE (Continued)

PLEASE CHECK THE FOLLOWING

THE UNIT(S) WON'T OPERATE

- Check the batteries in the Remote Control.
- Check that the power source is connected properly.
- Check if the in-house fuse and/or breaker is "ON".
- Check to see if the power is on.

COOL OPERATION IS NOT SATISFACTORY

- Check if the air filters are dirty.
- Check if the room temperature setting is correct.
- Check the horizontal louver.
- Check to see if the air intake or the discharge outlet have been blocked.
- Check if the air flow rate is correct.



CALL FOR SERVICE

- If the air conditioner(s) still have problems, disconnect the power source and consult your installer.
- If water drips from indoor unit(s).
- If the circuit breaker frequently trips.
- If foreign substances or water entered the internal system of the air conditioner(s).
- If it sounds strange during operation.
- If indoor unit(s) are not level.



TROUBLE CHECK BY SELF-TEST MODE

- If an abnormality occurs on the air conditioner(s), the operation is automatically stopped by the "Self-Diagnosis Function".
- If the operating light of main unit is blinking, please put the switch lever(s) on the indoor unit(s) in off (O)-position.

▪ 9/12 Btuh







Trouble Check by Self-Test Mode		▪:Blinking
State of LED	Contents of Defect	
	 (Green) LED	▪ Defect of room temperature sensor
	 (Orange) LED	▪ Defect of indoor heat exchanger sensor

▪18/24 Btuh

Trouble Check by Self-Test Mode		▪:Blinking
Contents of Defect		
 (Green) LED	▪ Defect of room temperature sensor	
 (Red) LED	▪ Defect of indoor heat exchanger sensor	
 (Green) LED	▪ Defect of compressor protection circuit (Cooling only Model)	

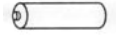
When self-diagnosis is cleared it returns to normal operation.

INSTALLATION (Single Zone Shown)

Parts of Indoor Unit			
No.	Part		Qty
1	Remote Control		1/unit
2	Remote Control Fixture		1/unit
3	Batteries 'LR03' (AAA)		2/unit
4	Manual		1
Parts of Outdoor Unit			
No.	Part		Qty
1	9/12 Btuh		4
	Rubber Cushion		
2	18/24 Btuh		4
	Rubber Cushion		
3	Drain Pipe		1

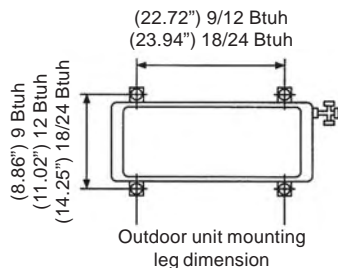
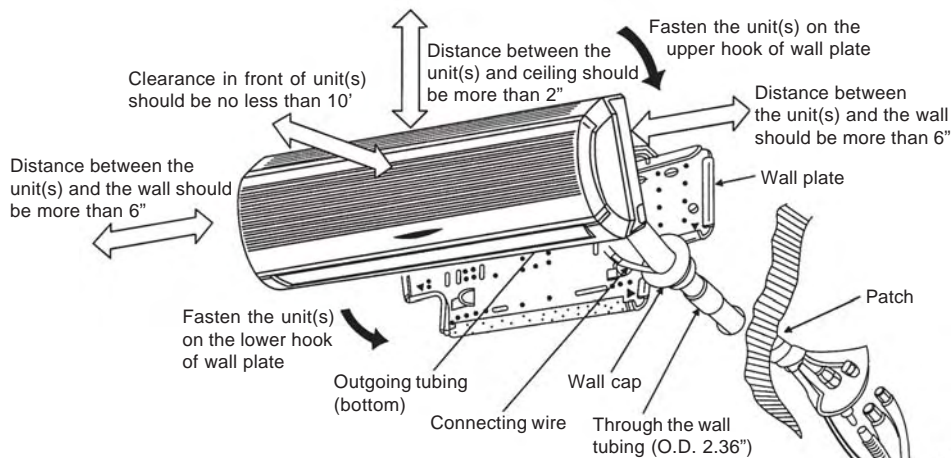

NOTE: Always check superheat and subcooling of system.

- Height limit: below 25ft.
- Maximum tubing length: below 50ft.

Tubing length over 25ft.

9/12 Btuh (Single or Multi-Zone)

- Charge additional refrigerant amount, additional refrigerant amount = 0.22oz./ft.>25'.

18/24 Btuh (Single Zone Only)

- Charge additional refrigerant amount, additional refrigerant amount = 0.44oz./ft.>25'.
- Capacity drops slightly.

CAUTION

- Read this installation manual thoroughly before installing the air conditioner(s) for proper installation.
- All field wiring must be installed by a licensed electrician and must comply with all national and local codes.
- All field piping must be installed by a licensed refrigeration technician and must comply with all national and local codes.
- Never plug unit(s) into an electrical outlet.
- Do not touch compressor, pipes and valves without protective gloves during and after operation, because these parts may become hot (more than 100°C (212°F)).
- Explain the operating procedure of the air conditioner to the customer.

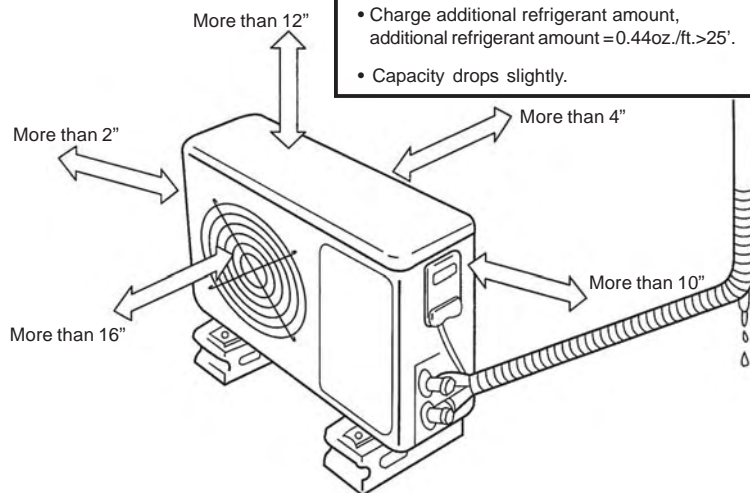

DETERMINATION OF INSTALLING POSITION

Install the Air Conditioner(s) by taking into account the following points, upon the customer's consent.

CAUTION

- Make sure that the indoor unit(s) are installed high enough, over 6 feet, (beyond reach of young children).

- Be sure chosen location can properly support the weight of the unit(s) and will provide adequate damping of vibration and noise.

Indoor Unit

- Do not install the unit(s) near a heat source.
- Be sure that air outlet and inlet are not obstructed.
- Be sure all clearances are as specified in the above figure (front, upper, left and right of the unit(s)).
- Allow convenient drainage and piping connection with the outdoor unit.
- Avoid installing the unit(s) in direct sunlight.
- Install the unit(s) on walls that can support their weight.

Outdoor Unit

- Insure chosen location can provide adequate drainage and good ventilation.
- Do not install in an area with flammable or corrosive vapors. Avoid salty air or sulfuric gas areas.
- Be sure all clearances are specified in the above figure (front, upper, left, right and rear of the unit) and also open on more than two sides.
- Be sure hot exhaust and noise does not bother the customer or their neighbors.
- Do not allow hot exhaust to blow directly on pets and plants.

MOUNTING OF THE INSTALLATION PLATE

1. Position the installation plate and check that it is level.

IMPORTANT: Always mount the installation plate horizontally by aligning the marking line with the thread or using a level.

2. Mount the installation plate horizontally and securely on structural members (studs, etc.) in the wall with four (4) installing screws. (See Fig. 1)
3. Make a $2 \frac{9}{16}$ " hole through the wall. Hole should be angled down to the exterior. (See Fig. 2)
4. Use a city grade wall pipe (outer diameter : $2 \frac{3}{8}$ ") as a sleeve to protect the interconnection cable and the piping. (See Fig. 2)

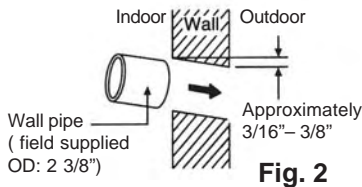

Fig. 2

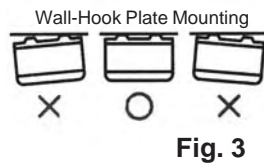

Fig. 3

9/12 Btuh

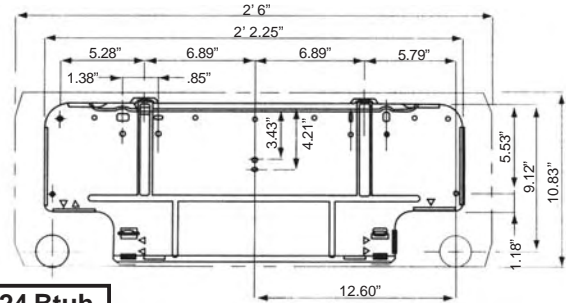

Fig. 1

18/24 Btuh

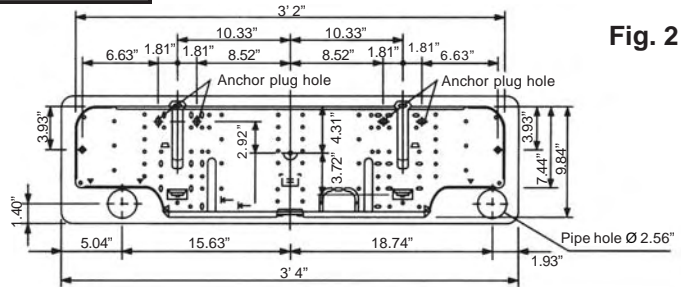

Fig. 2

INSTALLATION OF THE INDOOR UNIT(S) (Take care not to twist or crimp pipes during installation.)



When inserting the pipes, protect the ends from dust or moisture by covering the flare connections with a cap or tape.

For Right Rear Sided, Right Sided and Lower Sided Piping

NOTE: Do not apply excessive force to these parts.

1. For right side and lower side piping, cut the indoor unit base(s) with a hacksaw and deburr the cut end with a file. (See Fig. 5)
2. Hang the indoor unit(s) on the upper portion of the installation plate while inserting the vinyl-taped pipes through the wall hole. Engage the lower projection with the claws of the installation plate. (See Fig. 7)

NOTE: Make sure that the unit(s) are securely mounted, by slightly shaking the indoor unit(s).

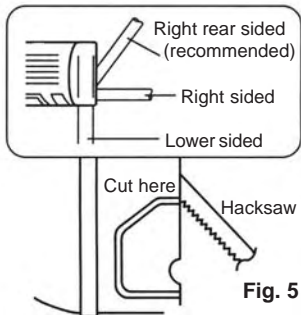

Fig. 5

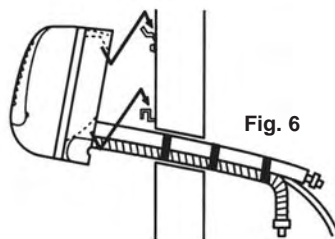

Fig. 6

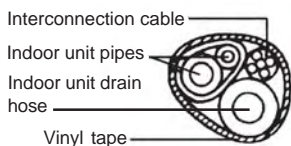
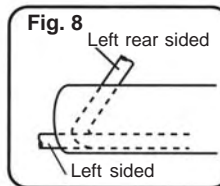

Fig. 7

For Left rear Sided and Left Sided Piping:

(See Fig. 8)



The length of the cable which will be passed through the wall hole should be longer than 40".

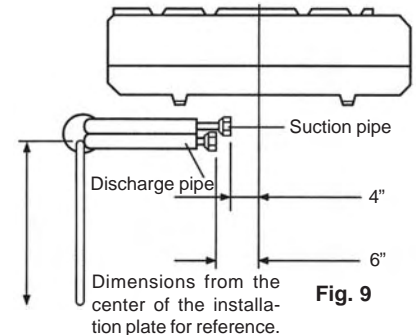

Fig. 9

1. Regarding the left rear sided and left sided piping, the pipes must be connected indoors and must be adjusted to the actual installing length. Keep these pipes unrolled (See Fig. 9 and Fig. 10)
2. For left side piping, cut the indoor unit base(s) with a hacksaw and deburr with a file.
3. Connect the indoor pipes and check for gas leaks.

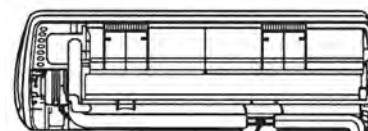

Fig. 10

(See Fig. 10) After the leak test, wrap the flared joints with insulation and fix it with bands.

4. Remove the spacer from installation plate.

INSTALLING OF THE OUTDOOR UNIT

- See the "Determination of Installing Position".

Connecting of Tubing

1. Cutting and flaring of tubing:

A. Cut the tubing on its straight part with the pipe cutter.

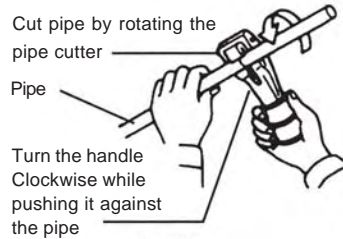

B. Remove burrs from cut edges of pipes, which may cause a gas leak.



C. Flaring of the pipe is done with the flaring tool.

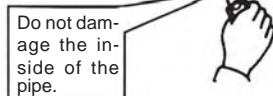

NOTE: Do not forget to install the flare nut before flaring



2. Pre-Connecting:

Screw the tubing turning 3 to 5 times until hand tight.

3. Fastening:

Fasten the connection.

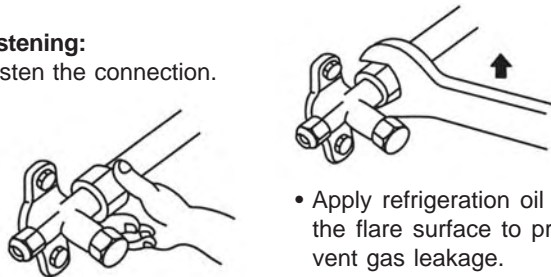

Air Purge and Charging



- 1) Remove the cap from the service port on the suction line service valve.
- 2) Connect the suction side of the refrigerant gauge manifold to the Suction Line service valve. Connect the center hose of the refrigerant manifold gauge to the micron gauge. Connect the other side of the micron gauge to the vacuum pump. (Diagram 1)
- 3) Open the suction side of the refrigerant manifold set and turn the vacuum pump on. **NOTE: Evacuate the system down to 400 microns.**
- 4) When the system pulls down to 400 microns turn the vacuum pump off. Observe the micron gauge: if the system has a leak the gauge will detect it. If there is a leak, find it, repair it, and repeat steps 3 and 4.
- 5) Close the refrigerant gauge manifold valve and disconnect the vacuum pump from the system.
- 6) Remove the Suction and Liquid line Service Valve Caps from the valves.
- 7) Using an Allen wrench, open the Liquid Line Service Valve until the valve is in the fully open position. Next do the same for the Suction Line Service valve. **NOTE: Be careful as not to completely remove the valve core from the valve. This will result in the release of refrigerant from the system into the atmosphere!**
- 8) Re-install the caps on both service valves. This completes the charging of the system.

Diagram 1

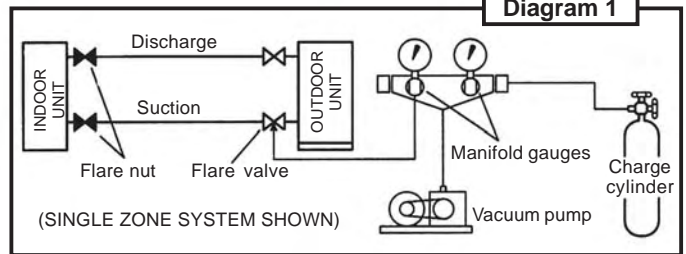

Leak Test

Leak Check

Check the joints with a gas leak detector or soapy water for refrigerant leaks. If a leak is found, repair and recheck.

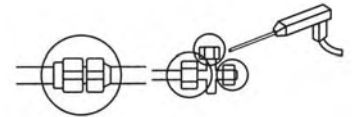

Drainage

Indoor Unit

After the indoor unit(s) have been installed, make sure that condensed water is properly drained. (If this is neglected, the unit(s) may become flooded.)

Special care should be given to the following details:

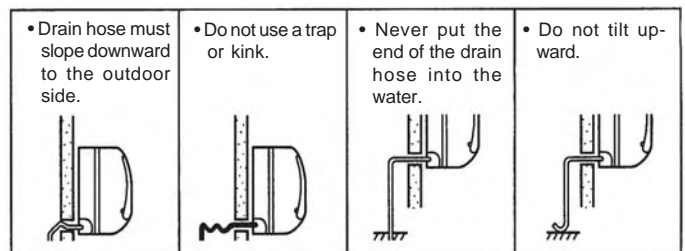

Outdoor Unit (Heat Pump Only)

NOTE: Allow clearance for drainage of water or condensate. For outdoor condensation:

- The outdoor unit has drain outlets on the base to drain condensation to the outside.
- To drain condensation by hose (5/8" hose) with the drain socket, connect the socket to the center of the base and cover all other outlets with base caps.
- Install the outdoor unit on a flat level surface and make sure condensation drains smoothly.
- In cold areas, condensation and defrost water can freeze, therefore do not use the drain outlet caps during the cold season.
- Electrical connection should only be made by a qualified professional.

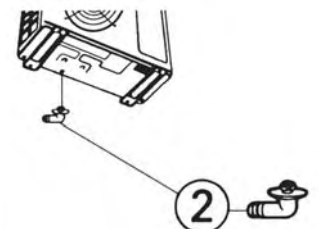

CONNECTING THE CABLE

- Use a dedicated circuit breaker for the air conditioner(s).
- When connecting the indoor unit(s) to the outdoor unit please be sure to connect the same number on the indoor and outdoor unit terminal blocks.
- Be sure to use approved connecting wire (14 gauge minimum).
- When installing the air conditioner, please be sure to use the right power supply cable conforming to Canadian Electrical Code/National Electrical Code.

NOTE: *Interconnecting voltage is 208/230V.*

- The air conditioner always requires grounding.
- Grounding must conform to local regulations.

HYUNDAI ELECTRICAL INTER-CONNECT REVISION "B" PRODUCT

Cool Model

HCW9000/HCW12000/HMCW18000/HMCW24000

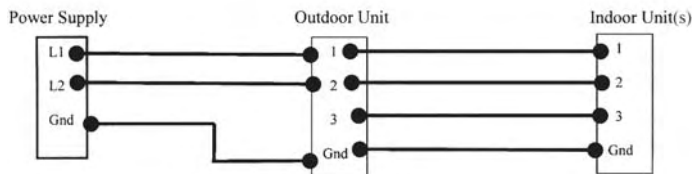

NOTE: For Multi-zone systems, there are two sets of identical wiring terminals. Be sure to match each air handler with its corresponding terminal strip connection. Use above diagram for each circuit.

HCW18000/HCW24000

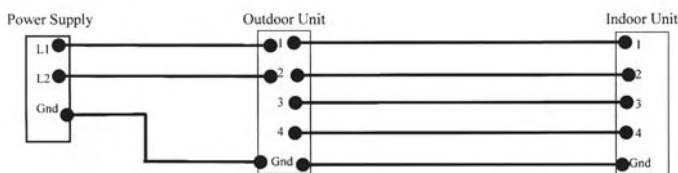

! CAUTION !

Make sure wire connections are secure otherwise electrical malfunction may occur.

Cool and Heat Model

HHW12000/HMHW18000/HMHW24000

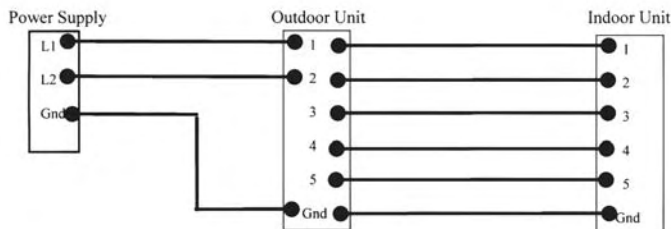

HHW18000/HHW24000

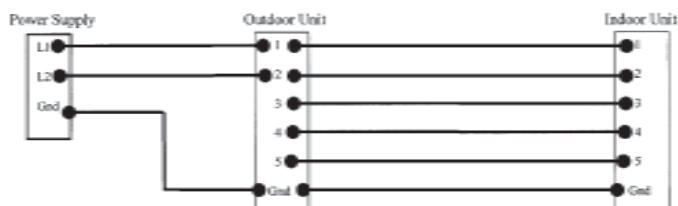

NOTE: *Gnd is Earth Ground*

- HACW/HACM are cooling only indoor units*
- HCCW/HCCM are cooling only outdoor units*
- HAHW is heat pump indoor unit*
- HCHW is heat pump outdoor unit*

! CAUTION !

- Connect one end of the ground wire to the outdoor unit ground terminal.
- Use minimum 14 AWG wire conductors between the indoor and outdoor units.
- Refer to page 16 to determine the wire size from the power supply to the condenser.

CONNECTING OF POWER SOURCE

! CAUTION !

Before supplying the power, check that the voltage is within $\pm 6\%$ of the rated voltage marked on the indoor unit label(s).

TEST RUN

- Be sure to check the power source, then turn the power on.
- Check the installation again.
- First, set the lever to OFF(O) position, then to ON(I) and TEST position slowly. (During the test, the indicator light will blink)
- After the test, set the lever to ON (I) position. The unit will stop the operation and hereafter the remote control will control the unit.

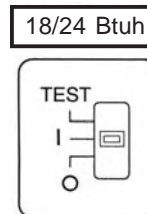
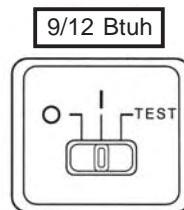

CABLE CONNECTION 9/12 Btuh (Single or Multi-Zone)

1. Wiring between units should be cut to length.
2. Remove the wiring cover of the Indoor Unit(s) and the Outdoor Unit.
3. Insert the connection wire into the terminal block.

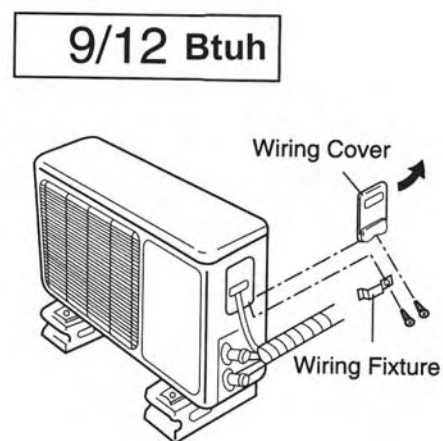
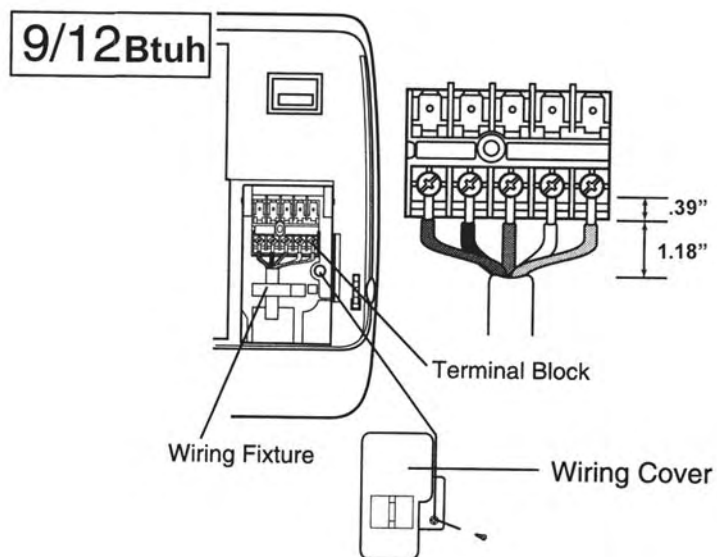

CABLE CONNECTION 18/24 Btuh (Single Zone Only)

18/24 Btuh

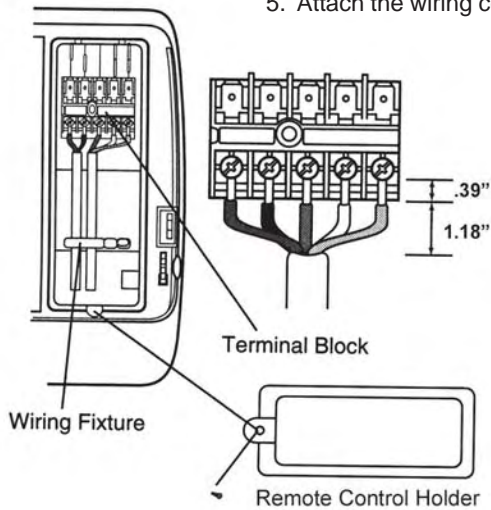

4. Fix the connecting wire between units, with wiring fixture.
5. Attach the wiring cover.

18/24 Btuh

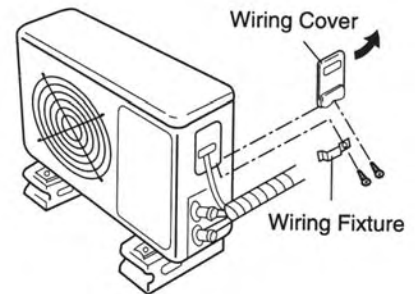

ELECTRICAL SPECIFICATIONS AND SYSTEM PERFORMANCE

Single Zone System	Cooling Capacity		SEER	Heating Capacity (Btuh) ⁽²⁾	HSPF	Volts/HZ/Phase	Total Amps	MCA	Max. Fuse
	Nominal ⁽¹⁾	Sensible							
HCW9000	9,500	7,030	10.9	-	-	208/230/60/1	5.0	6.1	15
HCW12000	12,000	8,760	10.6	-	-	208/230/60/1	6.2	7.6	15
HHW12000	12,000	8,760	10.4	12,500	7.2	208/230/60/1	6.2	7.6	15
HCW18000	20,000	14,200	10.7	-	-	208/230/60/1	10.2	12.5	20
HHW18000	20,000	14,200	10.3	20,000	6.9	208/230/60/1	10.2	12.5	20
HCW24000	24,000	16,800	10.3	-	-	208/230/60/1	12.1	14.8	25
HHW24000	24,000	16,800	10.0	24,000	6.8	208/230/60/1	12.0	14.8	25

(1) Indoor 80/67° F, Outdoor 95° F

(2) Indoor 70/58° F, Outdoor 47° F

Multi-Zone System	Cooling Capacity (Btuh)		SEER	Heating Capacity (Btuh) ⁽⁶⁾	HSPF	Volts/HZ/Phase	Cond Fan Mtr		Compressor Circuits 1 & 2		Indoor Fans		Total Amps	MCA	HACR BRKR	Min Volt
	Nominal ⁽⁵⁾	Sensible					AMPS	HP	RLA	LRA	AMPS	HP				
HMCW18000 ⁽¹⁾	18,000	12,600	10.9	-	-	208/230/60/1	0.72	0.2	4.45	26	0.22	0.06	10.1	11.1	15	197
HMHW18000 ⁽²⁾	17,400	11,700	10.0	17,700	6.8	208/230/60/1	0.72	0.2	4.45	26	0.22	0.06	10.1	11.1	15	197
HMCW24000 ⁽³⁾	24,000	15,500	10.6	-	-	208/230/60/1	0.72	0.2	5.85	29	0.22	0.06	12.9	13.4	20	197
HMHW24000 ⁽⁴⁾	21,000	14,100	10.0	21,250	6.8	208/230/60/1	0.72	0.2	5.85	29	0.22	0.06	12.9	13.4	20	197

(1) HMCW18000 consists of two HACM09DB (9,000 Btuh) air handlers and one HCCM09DB condenser.

(2) HMHW18000 consists of two HAHM09DB (9,000 Btuh) air handlers and one HCHM09DB condenser.

(3) HMCW24000 consists of two HACM12DB (12,000 Btuh) air handlers and one HCCM12DB condenser.

(4) HMHW24000 consists of two HAHM12DB (12,000 Btuh) air handlers and one HCHM12DB condenser.

(5) Indoor 80/67° F, Outdoor 95° F

(6) Indoor 70/58° F, Outdoor 47° F

COMPLETION OF INTERCONNECTING TUBING

- Insert the wall cap into the wall, and fill the gap with sealant to prevent rain or wind.
- When using the pipe cover, fill the gap in the wall through hole in the inside.

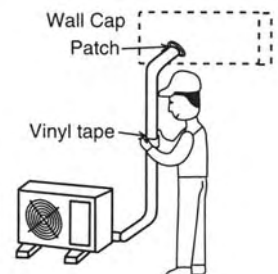

OPERATING CHARACTERISTICS (Single Zone Cooling)

All units operating on high speed fan

HCW9000

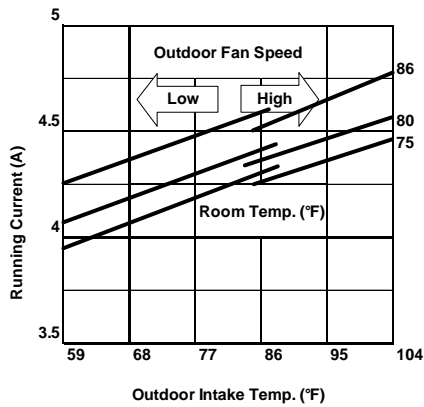
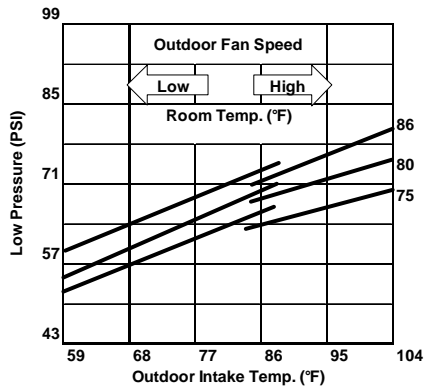

HCW12000 HHW12000

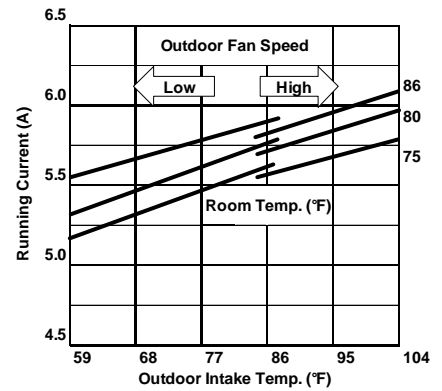
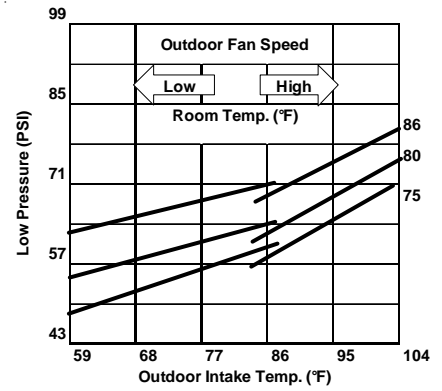

HCW18000 HHW18000

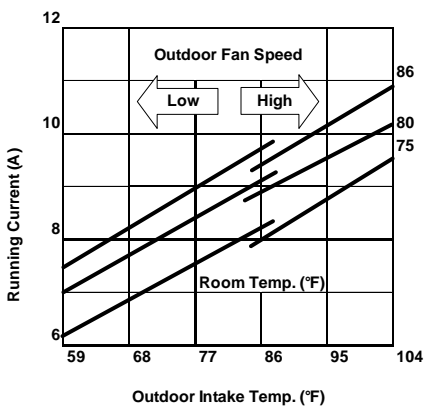
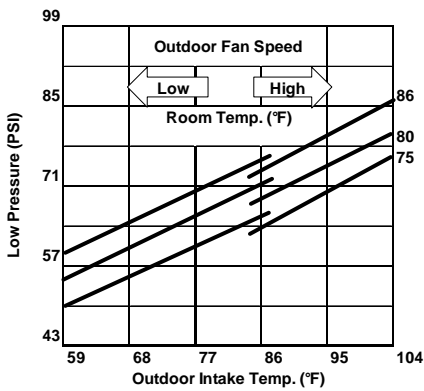

HCW24000 HHW24000

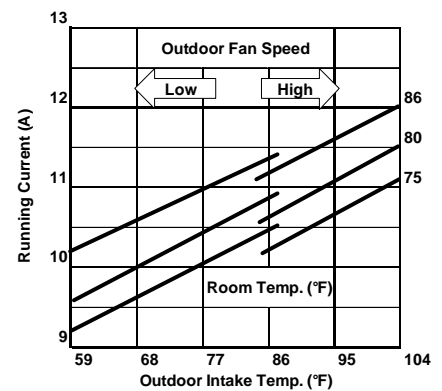
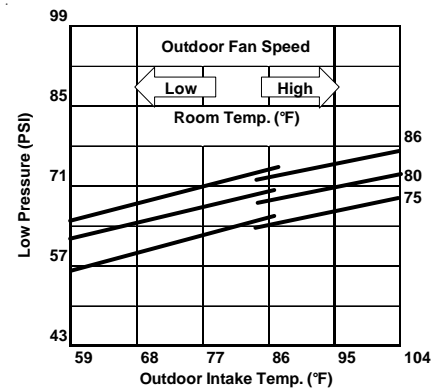

OPERATING CHARACTERISTICS (Single Zone Heating)

All units operating on high speed fan

HHW12000

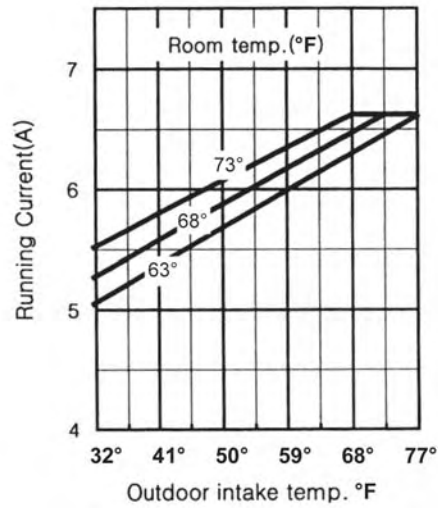
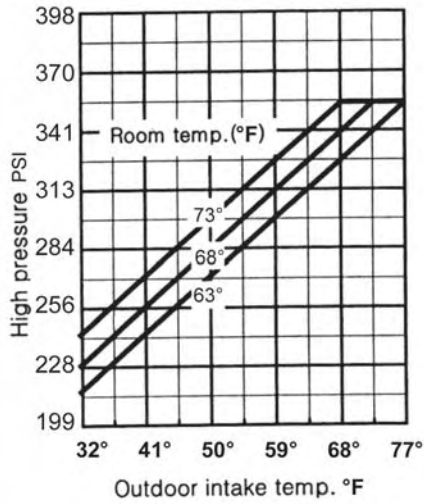

HHW18000

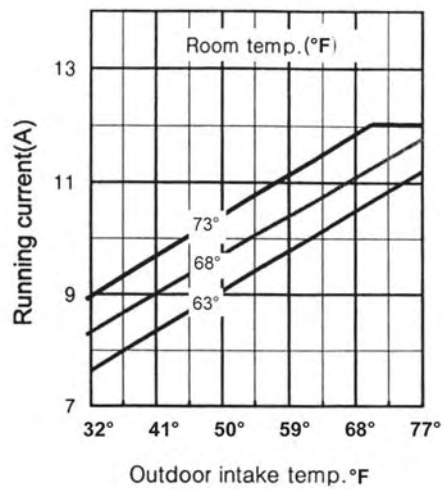
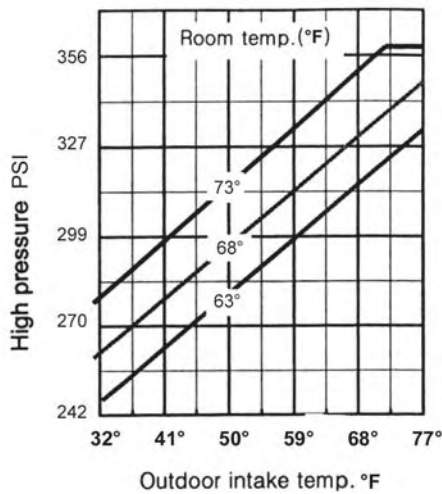

HHW24000

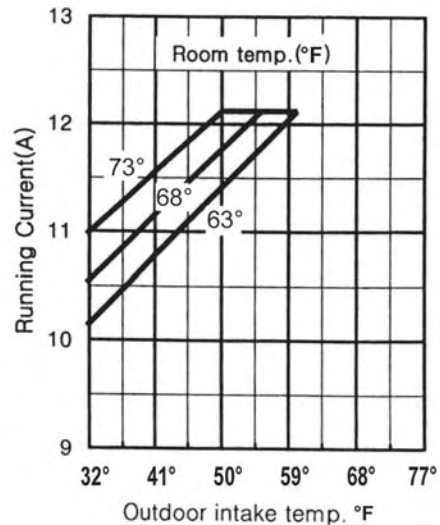
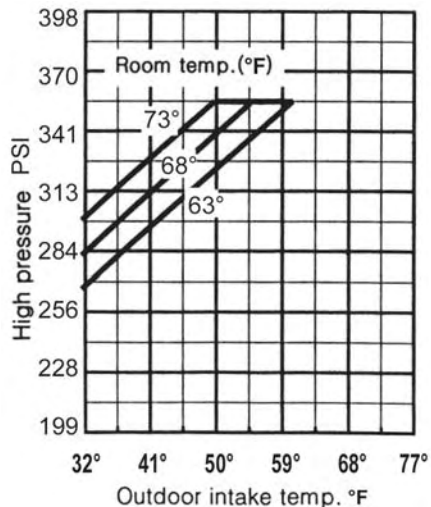

OPERATING CHARACTERISTICS (Multi-Zone)

All units operating on high speed fan

HMCW18000
HMHW18000

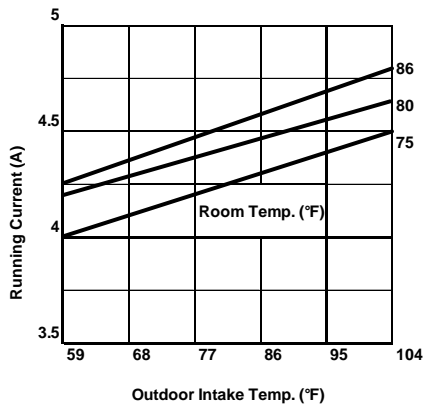
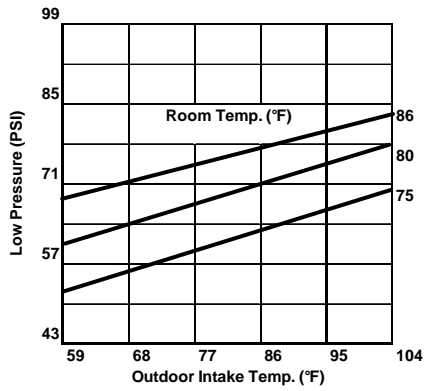

HMCW24000
HMHW24000

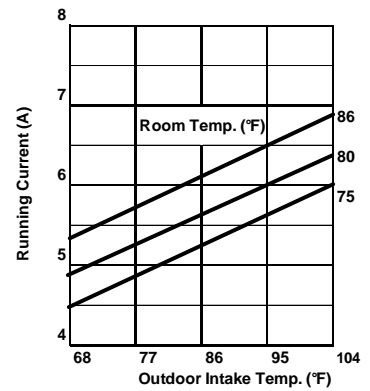
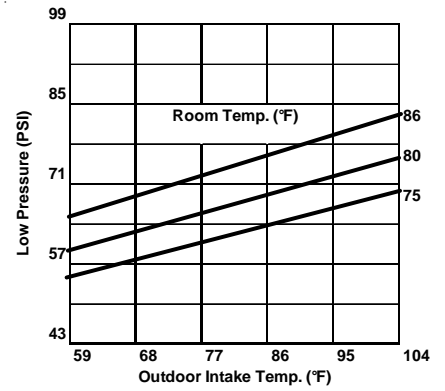

THERMISTOR CHARACTER DIAGRAMS

Remote Sensor

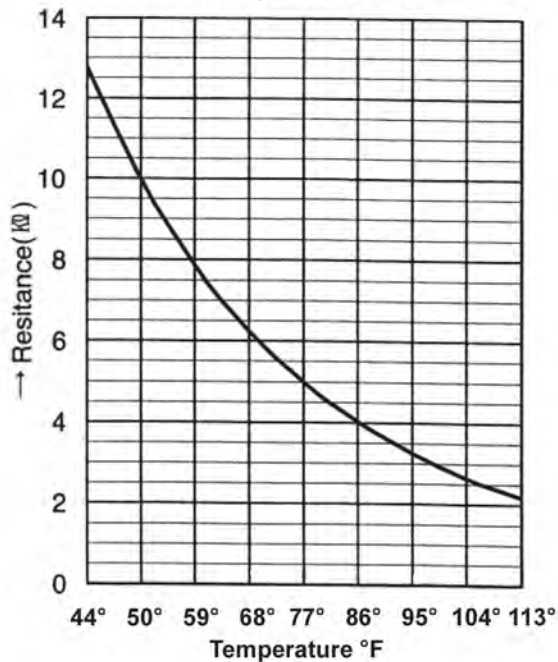

Room Air/Coil Sensor

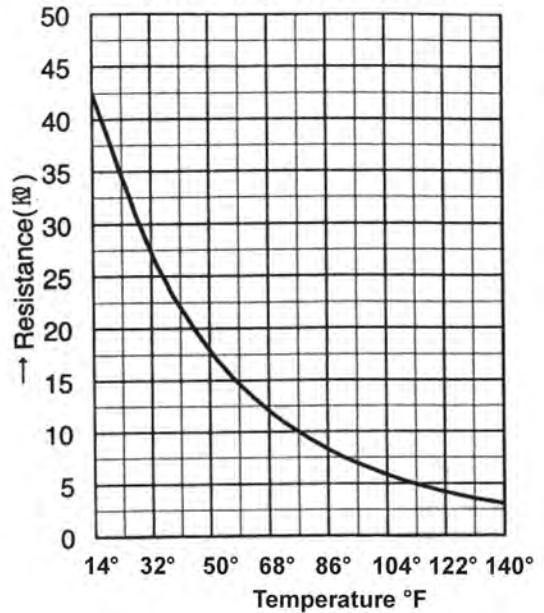

Free Manuals Download Website

<http://myh66.com>

<http://usermanuals.us>

<http://www.somanuals.com>

<http://www.4manuals.cc>

<http://www.manual-lib.com>

<http://www.404manual.com>

<http://www.luxmanual.com>

<http://aubethermostatmanual.com>

Golf course search by state

<http://golfingnear.com>

Email search by domain

<http://emailbydomain.com>

Auto manuals search

<http://auto.somanuals.com>

TV manuals search

<http://tv.somanuals.com>